

Table of Contents

Ordering Information	3	Nailhead Trim Options	9
Order Entry	3	Cut Yardage	10
Prices & Specifications		Pricing Formula (U+ Fabrics)	10
Cancellations and Changes	3	Warranty Information	11-12
Shipping and Storage.....	4	COM Information	13-14
Returns.....	4	COM Order Form	15-16
Freight Damage and Claims	4	Pricing	
Routings.....	4	Entree Dining	17
Options Matrix	5-6	Conrad Custom.....	33
Cushions		Urban Living	36
Cushions - Loose Seat.....	7	Throw Pillows	48
Cushions - Tight Seat.....	7	Upholstery Product.....	54
Finishes		Leather Product	192
Standard Upholstery Finishes.....	8	Casegood Product	284
Premium Upholstery Finishes	8	Monogram	336
Monogram Casegood Finishes	8		
Fairshield+ Upholstery Finishes.....	9		
Kickplates	9		

Ordering Information

- Please send all orders to orderdept@fairfieldchair.com
- All orders must be submitted in writing via a P.O. on your Company Purchase Order.
- **Please do NOT send orders to your customer relations representative.**

The following information must be provided to acknowledge your order.

1. Your purchase order number with billing address
2. Quantity
3. Model Number
4. Description
5. Finish
6. Fabric/Leather Selection: Pattern, Color, and Grade. If C.O.M., please submit a C.O.M. form with your order.
7. Options
8. Pricing (include cost of any options)
9. Indicate any tagging/sidemark or any other special instructions.
10. Shipping destination and any other shipping instructions.
11. Nailhead trim finish and size, unless standard, is desired.
12. When ordering a sectional, recliner, etc., that includes more than (3) pieces or more than (3) fabrics, a sketch or diagram must be included.

Order Entry

All orders are subject to final acceptance by Fairfield Chair Company in Lenoir, NC. No order will be entered for production or acknowledged until all specification information is complete (see above). Fairfield Chair Company attempts to clarify all purchase orders. However, in the event the model number, description, or name on the purchase order differ, the model number will prevail.

Acknowledgments will be made for each accepted order and contain the final order specifications on it. The buyer is responsible for checking the acknowledgment to make sure that every detail is correct. If any errors are found, it is the buyer's responsibility to contact our Order Entry Department immediately.

Receipt of our acknowledgment indicates acceptance of your order subject to the terms set forth on the acknowledgment. Any duplicate orders not clearly marked "Confirmation" are the responsibility of the buyer.

Prices and Specifications Subject to Change Without Notice

Variations in the tailoring, padding, and fabric thickness affect the dimensions and weights of each piece and should be expected. **Due to the handcrafted nature of our product, variations to plus or minus 1" of our listed measurements could occur.** Specifications are subject to change without notice.

Cancellations & Changes

Because all upholstery items are manufactured to the buyer's specifications, acknowledged orders cannot be canceled for any reason without the written authorization of Fairfield Chair Company.

- No verbal cancellations will be accepted, either from reps or customers.
- All cancellations must be emailed. If a cancellation is approved, it will be subject to a charge of up to 50% of the net price.

Orders for custom merchandise cannot be canceled for any reason (any modification to items included in this price list is considered custom). Fairfield Chair Company is not required to accept any changes to orders. For any accepted and authorized changes, Fairfield Chair Company reserves the right to charge for any expenses incurred due to the change. This includes fabric and other materials, labor, and any other costs, plus up to 25% of the net price. Order changes may also change production and ship date of your order.

Shipping and Storage

Fairfield is a ship as ready manufacturer; orders will be scheduled as ready and ship as pieces are completed. We will ship in accordance with customer instructions whenever possible. Freight will be calculated per shipment at time of invoicing based on applicable rate or minimum charge by ship to zone. Orders in production will be shipped as scheduled and cannot be held. If a customer is unable to accept an order when it is ready for shipment, storage may be requested. Acceptance of a storage request will be at the discretion of Fairfield Chair Company.

All costs including transportation will be at customer's expense. A storage charge of 7.5% of the invoice will be assessed for every 30 days, or any part thereof, that merchandise remains in storage. Fairfield Chair Company considers transfer to storage the equivalent of delivery. This includes invoicing and payment. Customers will bear all risk of damage or loss during storage.

Returns

If you suspect a manufacturing defect, please contact our Claims department at claims@fairfieldchair.com to request a return authorization form or log into your MY | FurnishWeb account to locate the claims form here: Invoice -> Click Invoice Number -> Service Request. Defective items must be inspected and confirmed by a Fairfield Chair Company representative. If a return is authorized, the item must be received at Fairfield Chair Company accompanied by a signed return authorization and five digital photos of the defect within thirty days of the return authorization issue date. Any damage, signs of use, missing parts, etc. are the sole responsibility of the buyer and will affect the amount of credit issued. Liability for defective merchandise shall be limited to the replacement or repair of that merchandise and Fairfield Chair Company shall not be liable for other damages or losses.

Freight Damage & Claims

Fairfield Chair Company is not liable for any damages to products that occur during transit or storage. The carrier assumes all responsibility upon acceptance of product. It is the buyer's responsibility to inspect products upon receipt and file any claims with the carrier.

- If products are received damaged, a written exception should be made on the bill of lading and an immediate inspection be requested of the carrier.
- Concealed damage must be reported to the carrier within 15 days of receipt.
- Failure to make claims shall constitute acceptance of the products and waiver any claims of defects, errors or shortages.
- Product that is moved from the original delivery address negates this warranty.

"Third Party", "Notify" and "Will Advise" Routings

Orders requesting special routing instructions such as "Third Party", "Notify" or "Will Advise", please note the following information:

Important Shipping Information:

Carrier must call (828) 610-2587 or fax (828) 726-8770 at least 24 hours in advance of pickup with acknowledgment number(s) to ensure orders are ready.

Shipping Hours: 7AM - 3PM, Monday - Friday.

Upon pickup, carrier must furnish acknowledgment number(s) to ensure correct orders are released.

Upon notification from Fairfield, we will hold the product for two weeks. If there is no communication within two weeks, Fairfield will ship acknowledgments "collect" with a furniture carrier of our discretion.

Note – Fairfield cartons all upholstery and casegoods items to assist in prevention of freight damage during transit. Our carton/packaging for upholstered items have been tested by a certified BIMFA testing lab.

Options Matrix

Option	Description	Pillows	Ottomans	Dining Chairs	Chairs	Recliners	Benches Chaises Loveseats Settees	Sofas Queen Sleepers	Extra Long Sofas
Backs (Loose Back)	Any loose back that is not already standard with Blendown, can be substituted for an additional charge.				\$60	\$60	\$120	\$180	\$240
Bullion Fringe (Skirt)	Factory must approve before accepting orders.		\$150		\$225		\$300	\$300	\$300
Banding (Base Trim)	Decorative tape band applied above the welt on platform. Factory must approve before accepting orders.		\$150		\$150		\$225	\$300	\$300
Banding (Decorative Tape Frame)	Decorative tape band frame inset on any loose back pillow.				\$150		\$225	\$300	\$300
Banding (Nails)	Contrast of fabric nail band at base of frame. Factory must approve before accepting order.		\$75		\$105		\$135	\$150	\$150
Banding (Decorative Tape Skirt)	Decorative tape band applied at the bottom of any frame with a skirt.		\$150		\$150		\$225	\$300	\$300
Breathable Denim Panel	For a faster transference of air, loose seat cushions can be upholstered with an optional fabric panel sewn to the bottom of the seat cushion. The fabric panel is made of a denim material which allows for air to transfer through the cushion more efficiently than the vented grommets. This mimics how we upholster leather cushions. Loose seat cushions upholstered this way are non-reversible.				\$36	\$36	\$75	\$105	\$144
Buttons (Contrasting)	Contrast fabric buttons.		\$45	\$45	\$45	\$45	\$45	\$45	\$45
Combination of Fabrics (Inside - Outside)	Combination of fabrics is available on ottomans, chairs, loveseats and sofas. If two Fairfield fabrics are used, the merchandise will be priced at the higher grade price. <i>Contrasting welt is not considered the second fabric.</i>								
Combination of Leathers (Inside - Outside)	Combination of leathers is available on ottomans, chairs, loveseats and sofas. If two Fairfield leathers are used, the merchandise will be priced at the higher grade price. <i>Contrasting welt is not considered the second fabric.</i>								
Combination of Leather & Fabric	Combination of leather and fabric is available on ottomans, chairs, loveseats and sofas. If both Fairfield leather and fabric are used, the merchandise will be priced at the higher grade price.								
Cushions (Loose Seat)	Any loose seat cushion that is not already standard with Blendown, Spring Down, Endurance, or Classic Plush can be substituted for an additional charge.		\$60		\$60	\$60	\$120	\$180	\$240
Cushion Tie-Downs	Optional cushion tie downs are available on items containing loose seat cushions. Tie-downs are standard on all single bench seat sofa cushions.				\$30		\$60	\$90	\$120

Options Matrix (continued)

Option	Description	Pillows	Ottomans	Dining Chairs	Chairs	Recliners	Benches Chaises Loveseats Settees	Sofas Queen Sleepers	Extra Long Sofas
Decorative Cord/Fringe	Decorative welt cords and fringes are available as an optional feature for an additional charge. Cut yardage is also available at a charge of \$24 per yard for cord and fringe. The minimum is 1 yard.	\$36	\$105		\$150	\$150	\$240	\$270	\$270
Glides (Set of 4)	Our standard 5/8" tan nylon glide can be upgraded to any of our optional glides for an additional charge - <i>for options, visit fairfieldchair.com</i> Please Note: <ul style="list-style-type: none"> Clearly specify corresponding glide number when submitting your order. Please consult with the flooring manufacturer for recommendations on the appropriate glides to be used on specific floor coverings. Regular inspection and cleaning of glides is suggested. Replace worn glides to protect your floors. 		\$18	\$18	\$18		\$18	\$18	\$18
Knee-Tilt	Locking mechanism to prevent the chair from rocking. (Gas Lift included).				\$90				
Moisture Barrier Deck (Loose Seat Only)	This beige decking is constructed of a 100% double-knit polyester that has been treated with an oven-dried, multiple step process designed to impart water repellency, stain repellency and anti-microbial properties.				\$36	\$36	\$75	\$90	\$90
Moisture Barrier Seat Only (All Seat Types)	A plain Moisture Barrier liner is designed to protect the foam and cushioning from penetration of liquids. This liner is anti-bacterial, anti-fungal, mildew resistant and meets CAL 117-2013 requirements.		\$75	\$90	\$90	\$90	\$180	\$270	\$270
Throw Pillows (Contrasting)	Contrasting pillows can be ordered where the pillow(s) are a standard feature. Some frames ordered in leather/vinyl will not come standard with pillows.								
	Grade D through U (Fairfield Fabrics)	No Charge							
	Grade U+ (Fairfield Fabrics) and Graded-In Fabrics (D through U).	\$90							
	For graded-in fabrics above Grade U, use the following formula: (# of grades above U) x 5.10 plus \$90, per pillow.								
Welt (Contrasting)	Contrasting welt in (Fairfield Fabrics).	\$15	\$60	\$75	\$75	\$75	\$90	\$105	\$105
	For graded-in fabrics above U, please call for pricing.								
	Contrasting welt cut on Bias.	\$45	\$75	\$90	\$90	\$90	\$150	\$150	\$150
	Contrasting welt in leather.	\$60	\$150	\$180	\$180	\$180	\$285	\$330	\$330

Cushions - Loose Seat



Cushion	Ultra Plush (UP)	Blendown (BD)	Spring Down (SD)	Endurance	Repose	Classic Plush
Standard/Optional	Standard (on select frames)	Standard/ Optional	Optional	Standard/Optional (Contract & Senior Living Frames)	Standard (on Reclination frames)	Standard/ Optional
Firmness	Soft	Medium	Firm	Firm	Soft	Medium
Foam Core Density	2.0	2.0	2.0	2.5	2.0	2.0
Indentation Force Detection (IFD)	21	24	22	31	23	26
Foam Caps	Convuluted 1.1 Density	N/A	Marshall Spring with 3" Coils	N/A	N/A	N/A
Fiber Caps	N/A	N/A	3/4 oz. Fiber	3/4 oz. Fiber	3/4 oz. Fiber	2 oz. Fiber
Foam Book Wrap	1.25 oz. Fiber	N/A	N/A	3/4 oz. Fiber	3/4 oz. Fiber	3/4 oz. Fiber
Fiber Down	N/A	N/A	50/50 Fiber Down, 95/5 Feather Down	N/A	N/A	N/A
Ticking	1.25 oz. Kimcloth	Down Proof Ticking	Down Proof Ticking	N/A	Down Proof Ticking	1.25 oz. Kimcloth

Refer to Options on page 5 for additional cushion pricing.

Cushions - Tight Seat

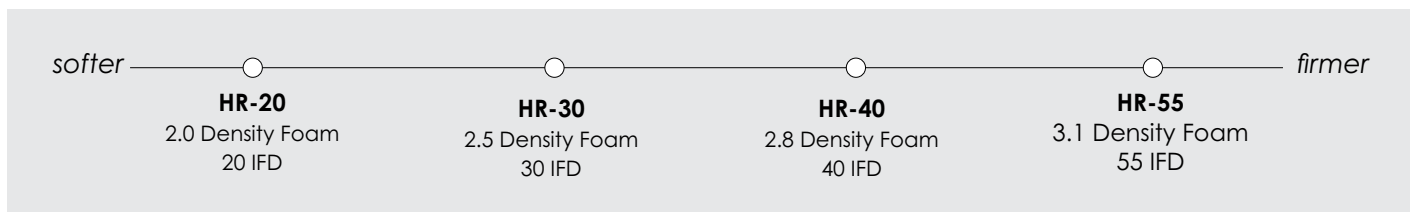

HR - A high-resiliency foam used on most tight seats.

Wood Finishes

All of our hand-applied finishes require multiple steps from our skilled American artisans. As a result, each piece will be unique with variations in color, shading, burnishing, distressing, crackle and/or texture. Each piece is treated as a true work of art, for one of a kind pieces that are rich in beauty and character. All standard and premium upholstery finishes are available with FairShield+ topcoat by specifying the suffix “-FS” following the name of the finish (i.e. Almond Buff-FS).

Standard Upholstery Finishes

Almond Buff	Dark Sable	Hazelnut	Modern Truffle	Smoked Stone
Antique Pinewood	English Honey	Light Cherry	Montego Bay	Tahitian Pearl
Black	Espresso	Linen	Pearl	Tobacco
Café Mocha	Graphite	Manhattan	Sable	Toffee
Cerused Espresso	Graystone	Mica	Sheer Dove	Walnut

Note: A custom match finish is available with a minimum order of 50 items for an additional charge of \$60 per style, per match finish. Please submit a finish sample for review and approval. Contact your customer service representative for more information. Fairfield cannot match paint finishes. Please note that if additional labor is required, additional charges may apply.

Premium Upholstery Finishes

American Navy Soft White

Product Type	Upcharge
Benches / Settees	\$600
Cocktail Ottomans	\$600
Dining Chairs / Bar & Counter Stools	\$525
Lounge Chairs / Recliners / Swivel Chairs	\$225

Product Type	Upcharge
Occasional Chairs	\$525
Ottomans - Matching to Chairs	\$225
Sofas / Queen Sleepers / Loveseats / Chaises	\$300

Monogram Casegood Finishes

Almond Buff	Charcoal	Hazelnut	Smoked Stone
American Navy	Dark Sable	Linen	Soft White
Antique Pinewood	English Honey	Modern Truffle	Tahitian Pearl
Cerused Espresso	Flint	Sheer Dove	Tobacco

Wood Finishes (continued)

FairShield+ Upholstery Finishes

FairShield+ topcoat (available on upholstery finishes only) offers enhanced chemical, moisture, mar and scratch resistance; ideal for high-use commercial environments or the every-day wear and tear of residential environments. The clear top-coat conversion varnish forms a chemically cross-linked barrier that is more resistant to wear and abrasion and is more impervious to moisture and commercial cleaning materials. FairShield+ is also formulated with UV inhibitors to reduce the harmful effects of sunlight and features silver ion technology (antimicrobial agent) to help preserve the finish and protect it against mold, mildew, fungus and odor-causing bacteria.

Cleaning Tips for FairShield+ Upholstery Finishes

The "silver ion" technology in our FairShield+ finish topcoat means that it deters the growth of bacteria. Clorox wipes can be used to clean and remove soiled areas on the finish surface, using the wipe on, wipe off method. First, wipe on the surface with a Clorox wipe. Then immediately wipe off with a damp cloth. Agents with less than 5% ammonium chloride and agents with sodium chloride or sodium chlorite may also be used to clean the finish surface. After cleaning the finish surface with one of these three agents, we strongly suggest that the finish surface be cleaned with warm, clear water and dried with a soft cloth.

Note: All standard upholstery finishes are available as FairShield+ by specifying the suffix "FS" following the name of the finish (i.e. Cafe Mocha-FS).

Wood Cleaning & Care | Standard, Premium Upholstery Finishes & Monogram Casework

- It is important to ensure that the surface is dried.
- Always wipe in the direction of the wood grain.
- Household polishes that are wax free and silicone free can be used on an infrequent basis (we recommend Guardsman Furniture Polish).
- Routine cleaning will prevent long term damage from dirt and grease which will form a film over time, dulling and discoloring the finish.
- Using anything other than a mild soap solution and then drying the surface with a soft cloth may damage the finish.
- Where possible, keep finish away from exposure to direct sun. Over time sunlight may change the color of the finish, and/or damage the finish.
- Avoid extreme temperature or moisture as they can cause wood to expand or contract leading to potential coating damage.

Kickplates - Bar and Counter Stools

Kickplate finish for bar and counter stools will be consistent with selected nailhead trim.

- Nickel or pewter nails will have a nickel kickplate.
- Brass nails will have a brushed brass kickplate.
- Aged bronze nails will have an aged bronze kickplate.
- Black Nickel nails will have a black nickel kickplate.

If no nailhead trim is used, the standard kickplate will be brushed brass, unless otherwise specified.

Nailhead Trim Options

When selecting your nailhead trim, please specify the number, size, and color (**example: 1009 Small Pewter**).

If a frame is standard with nails, Brass finish will be applied, unless otherwise specified.

Please see individual items in price list for availability and pricing. Please see the website for color photos of each nail.

SMALL 1/2"	Applied in a fashion that each nailhead touches the previous nailhead.					
Available in the following colors:	1009 Small Brass (Standard)	1009 Small Bright Brass	1009 Small Nickel	1009 Small Pewter	1009 Small Aged Bronze	1009 Small Black Nickel

MEDIUM 5/8"	Applied with consistent finger width spacing between each nail.					
Available in the following colors:	1054 Medium Brass	1054 Medium Bright Brass	1054 Medium Nickel	1054 Medium Pewter	1054 Medium Aged Bronze	1054 Medium Black Nickel

When selecting a combination of small or medium nails you must include the cost of each nail size applied. For instance, if you select a small nail and a medium nail combination, you will need to add the cost of each nail size to the price of the piece.

Cut Yardage

Prices listed below are based on 54-inch wide fabric. **A minimum order is one yard.** Shipping and handling will be added.

D Grade	\$30
E Grade	\$36
F Grade	\$42
G Grade	\$48
H Grade	\$54
J Grade	\$60
K Grade	\$66
L Grade	\$72
M Grade	\$78
N Grade	\$84
O Grade	\$90

P Grade	\$96
Q Grade	\$102
R Grade	\$108
S Grade	\$114
T Grade	\$120
U Grade	\$126
U+1 Grade	\$132
U+2 Grade	\$138
U+3 Grade	\$144
U+4 Grade	\$150
U+5 Grade	\$156

U+6 Grade	\$162
U+7 Grade	\$168
U+8 Grade	\$174
U+9 Grade	\$180
U+10 Grade	\$186
U+11 Grade	\$192
U+12 Grade	\$198
U+13 Grade	\$204
U+14 Grade	\$210
U+15 Grade	\$216
U+16 Grade	\$222

U+17 Grade	\$228
U+18 Grade	\$234
U+19 Grade	\$240
U+20 Grade	\$246
U+21 Grade	\$252
U+22 Grade	\$258
U+23 Grade	\$264
U+24 Grade	\$270
U+25 Grade	\$276

Pricing Formula (U+ Fabrics)

Each frame lists individual pricing from grades D through U; however, some fabrics may fall beyond U grade. These fabrics are graded using a **“U+” format**.

Fairfield uses the following formula for “U+” fabrics:

$$(\# \text{ of grades above U}) \times \text{Riser} + \text{U Grade} = \text{Price}$$

Please Note: Risers, U Grade Pricing and U+ Pricing Formulas are provided for each individual item throughout the price list. See each individual frame for this information.

For example*: If you choose to upholster the 1431-01 Lounge Chair in fabric 4995 Poppy (which currently is a U+8 grade), you will use the following formula:

$$8 (\# \text{ of grades above U}) \times \$15 (\text{Riser}) + \$2,340 (\text{U Grade price}) = \$2,460$$

1431-01 Lounge Chair in fabric 4995 Poppy (U+8) would be \$2,460*

*This example is for illustrative purposes only.

Fairfield Warranty Information

Upholstery	Residential Coverage*	Commercial Coverage*	Exclusions
Workmanship	One (1) year	One (1) year	Fairfield warrants standard catalog products for one (1) year from the date of invoice to the original agent/dealer against defects in workmanship when put to ordinary use. This warranty does not cover damage or injury caused by unreasonable or abusive use, climatic/environmental conditions, issues caused during installation, freight damage, unauthorized repair, failure to provide necessary or reasonable care, by accident, alteration, tampering or negligence.
Frames	Limited Lifetime	Five (5) years	If these components do not perform as expected under normal conditions, these items will be repaired or replaced at No Charge, once our staff has determined "liability." This service policy extends solely to the original customer under conditions of normal use and service.
Fabrics	Not Warranted	Not Warranted	Fairfield does not guarantee and will not assume responsibility for color fastness or the wearing qualities of any fabric. Any adjustment made will depend on the fabric manufacturer's willingness to stand behind their product. We cannot be responsible for color variations beyond a reasonable commercial match. Fairfield will not be responsible for fabric that has been treated with a stain-repellent finish by the customer. Fairfield will not be responsible for costs associated with repair or replacement of fabrics that deteriorate, delaminate or other wise fail in the field. Always refer to textile cleaning and care methods provided by the fabric manufacturer. Fairfield does not warrant damage to fabrics caused by improper cleaning and care methods.
Customer's Own Material (COM) or FOM (Graded-In purchased on behalf of the customer)	Not Warranted	Not Warranted	Once a COM or FOM fabric is inspected, measured and accepted, Fairfield assumes no responsibilities for its overall performance, flammability, durability, color fastness, or any other quality issues after upholstery on a Fairfield product. Fairfield will not be held responsible for any tailoring variance that results from the application of a particular fabric to a specific frame. All COM and FOM fabrics must have backing applied or will be rejected for upholstery. Fairfield reserves the right to refuse any material not suitable for upholstery sent in to be used as COM. Fairfield will not be responsible for fabric that has been treated with a stain-repellent finish by the customer. Fairfield will not be responsible for costs associated with repair or replacement of fabrics that deteriorate, delaminate or other wise fail in the field. Always refer to textile cleaning and care methods provided by the fabric manufacturer. Fairfield does not warrant damage to fabrics caused by improper cleaning and care methods.
Leather	Not Warranted	Not Warranted	The following properties are not covered under this warranty: Colorfastness, Shrinkage, Wrinkling and Stretching. Leather is a natural material, with every hide uniquely enhanced by natural features. Wrinkles, scratches, insect bites, healed scars, naturally occurring color variations, and other natural markings are not flaws. To limit naturally occurring variations, reduce exposure to direct sunlight, extreme temperatures, and washing. Body oils and perspiration can change the color and appearance of leather.
Ultra Plush, Reclination Repose, and Classic Plush Seat Cushions	Limited Lifetime	One (1) year	If these components do not perform as expected under normal conditions, these items will be repaired or replaced at No Charge, once our staff has determined "liability." Cushions can lose 1/2" - 3/4" of loft during the break-in period. This is considered normal and not a defect. This service policy extends solely to the original customer. Regular maintenance, rotating and fluffing is recommended for all cushions.
Blendown and Spring Down Seat Cushions	Limited Lifetime	One (1) year	If these components do not perform as expected under normal conditions, these items will be repaired or replaced at No Charge, once our staff has determined "liability." Cushions can lose 1/2" - 3/4" of loft during the break-in period. This is considered normal and not a defect. Compression of blendown materials and occasional loss of feathers and loss of shape is considered normal. This service policy extends solely to the original customer. Regular maintenance, rotating and fluffing is recommended for all cushions.
Endurance Seat Cushions	Limited Lifetime	Five (5) years	If these components do not perform as expected under normal conditions, these items will be repaired or replaced at No Charge, once our staff has determined "liability." Cushions can lose 1/2" - 3/4" of loft during the break-in period. This is considered normal and not a defect. This service policy extends solely to the original customer.
Back Pillows	Limited Lifetime	Five (5) years	Warranty does not cover normal compression of fillings materials. Fluff all semi-attached back pillows and rotate and fluff all loose back pillows regularly.
Arm Pillows	One (1) year	One (1) year	Warranty does not cover normal compression of fillings materials. Fluff all throw pillows regularly.
Knee-Tilt and Gas Lift Mechanisms	Two (2) years	Two (2) years	Under conditions of normal use and service.
Manual Executive Swivel Bases and Mechanisms	Five (5) years	Five (5) years	Under conditions of normal use and service.
Casters	Five (5) years	Five (5) years	Fairfield's standard caster is suitable for most floors. Our casters function best on a low pile carpet or solid flooring. We cannot control how carpet or flooring will limit the caster's ability to function. Fairfield does not accept liability for damages to a floor that might be created by the use of an improper caster. Always consult the flooring manufacturer for recommendations of caster use.
Glides	Not Warranted	Not Warranted	Fairfield's standard glide is suitable for most floors; however, we offer specialty upcharge glides which may be preferable on certain types of flooring. Fairfield does not accept liability for damages to a floor that might be created by the use of an improper or incorrect glide. Always consult with the flooring manufacturer for their recommended glide.
Reclination Motion Battery Packs	One (1) year	One (1) year	
Reclination Motion Control Switches	One (1) year	One (1) year	
Recliner Mechanisms (non-motorized)	Three (3) years	Three (3) years	Fairfield will replace defective parts of inner mechanisms and pay installation costs up to \$150 for the first (1) year. Within three (3) years inner mechanism will be replaced by Fairfield, but freight and installation costs are not included after the first (1) year. After three (3) years, the inner mechanism may continue to be serviced, but Fairfield reserves the right to charge for repair or replacement of any mechanism.
Recliner Mechanisms (motorized)	Three (3) years	Three (3) years	Fairfield will replace defective parts of inner mechanisms and pay installation costs up to \$150 for the first (1) year. Within three (3) years, a defective inner mechanism will be replaced by Fairfield, but freight and installation costs are not included after the first (1) year. After three (3) years, the inner mechanism may continue to be serviced, but Fairfield reserves the right to charge for repair or replacement of any mechanism.
Swivel and Swivel Glider Mechanisms	Three (3) years	Three (3) years	Under conditions of normal use and service.
Sleeper Mechanisms	Two (2) years	Two (2) years	Under conditions of normal use and service.
Innerspring Sleeper Mattresses	Five (5) years	----	Under conditions of normal use and service.
Renting, recovering, misuse or abuse	Not Warranted	Not Warranted	
Damage due to carrier or customer handling	Not Warranted	Not Warranted	Should damage be discovered after delivery, you are responsible for filing a written concealed damage claim with the carrier, requesting the carrier to make an inspection, and creating a written damage report for the carrier. Freight claims must be communicated within 15 days of receipt of products. Products that are moved from the original delivery address and are not inspected at the time of receipt negate this warranty. Storage or installation of Fairfield products in any facility other than a temperature and humidity controlled environment voids all warranties, expressed or implied.

Fairfield Warranty Information *continued*

Casegoods	Residential Coverage*	Commercial Coverage*	Exclusions
Casegood Wood Products	One (1) year	One (1) year	Fairfield warrants standard catalog products for one year from the date of invoice against defects in workmanship when put to ordinary use. This warranty does not cover damage or injury caused by unreasonable or abusive use, climatic/environmental conditions, issues caused during installation, freight damage, unauthorized repair, failure to provide necessary or reasonable care, by accident, alteration, tampering or negligence. Variations in raw materials, wood grain, color, texture, markings and distressing are inherent natural characteristics of wooden furniture. Natural color changes, variations, or movement in lumber or veneer products, and exposure to extreme temperature changes and/or direct sunlight, may cause color and/or surface changes which are not considered defects. Certain casegood products are made with a variety of materials found in nature. These include, but are not limited to, various wood and plant species, stone and minerals, shells and certain animal bi-products. Fairfield warrants these materials free from defects and workmanship for a period of one (1) year from date of invoice to the original agent/dealer. However, certain changes in these materials over time are expected and are not considered defects.
Marble and Stone Tops	120 Days	120 Days	Marble and stone tops are warranted to be free of defects in material and workmanship when put to ordinary use for 120 days from the date of invoice. Variations in raw materials, color, texture, veins and voids are a natural character of this product and are not considered a defect. Due to the absorbent characteristics of genuine marble, Fairfield does not warrant against stains that occur as result of spills. Marble and Stone should be inspected at the time of delivery.
Acrylic, Glass and Mirrors	120 Days	120 Days	Acrylic, Glass and Mirrors are warranted against defects in materials and workmanship when put to ordinary use for 120 days of invoice. Chips and scratches that occur from handling after delivery are not the responsibility of Fairfield. Glass and Mirror products should be inspected at the time of delivery.

General Warranty Statements

The following conditions apply to this warranty except where prohibited by law:

This warranty is valid for the original agent/dealer from the date of invoice and warrants the products to be free of defects in materials and workmanship when put to ordinary use for the length of time specified.

It is always the primary intention of Fairfield to deliver first quality furniture to our customers. Should a manufacturing issue or transit-related damage arise, Fairfield reserves the right to repair or replace the item(s) involved. If a local medic can sufficiently repair and restore the piece(s) to first-quality condition, Fairfield will proceed in that manner. On-site repairs allow the customer to begin utilizing the product sooner and avoid unnecessary costs and time delays involved in a replacement.

Warranty service is handled through the original furniture agent/dealer. Should service be needed, contract your furniture agent/dealer. After receiving Fairfield authorization, the agent/dealer will either repair, replace or return the defective item(s) to the factory for review and disposition. Fairfield's responsibility for transportation cost and labor is limited to one (1) year from the original invoice date and for transportation between the agent/dealer's original shipment location and the factory. If the product has been moved to another location than the original shipment receipt location, Fairfield is not responsible for the transportation cost to return to the original shipment receipt location.

Replacement parts for office mechanisms, office bases, loose seat cushions, back pillow cores, and swivel bases are without charge when covered under this warranty. Installation of these items is the responsibility of the agent/dealer and is not covered by this warranty.

Fabric matching standards will be determined by Fairfield unless specified by the customer. Please note that seams are often required when applying the material in a non-railroaded (directional) application. This application is at the discretion of Fairfield and is not considered a defect in workmanship.

Color variations in finishes - some unavoidable natural variations occur in wood species, both solids and veneers, and are an inherent natural characteristic of wooden furniture. These characteristics are not considered a defect in materials or workmanship and therefore are not a basis for a warranty claim.

Our upholstered frames are constructed to support individuals up to 300 pounds per seat and our Bariatric Chairs are constructed to support individuals up to 500 pounds per seat. Testing results are based on BIFMA standards.

Consequential and incidental damages are excluded from this warranty. This warranty gives you specific legal right, and you may also have other rights that vary from state to state.

Alterations of any type to the product by the customer/agent/dealer will nullify the warranty entirely.

*Coverage of warranty begins at date of invoice.

Customer's Own Material (COM) and Customer's Own Leather (COL)

Important notes to review before submitting COM or COL documents or quotes

- All COM orders will be priced at the "K" Grade price.
- All COL orders will be priced at the "M" Grade price.
- See Price list or website for COM yardage and COL square footage requirements.
- All COM fabrics must be backed before shipping.
- Any special instructions must accompany the COM form or the fabric will be cut at the factory's discretion.
- If more than two fabrics are to be applied per frame, the frame will price at the highest grade of fabric selected with the exception of Contrast Welt fabric or leather selections. COM Form is required for fabric quote.
- For stripes, plaids and matching designs, please refer to the chart on the next page for yardage requirements.
- Please note that all stripes will be applied vertically, unless otherwise indicated.
- We reserve the right to determine if a COM pattern layout fits our cutting procedures.
- All fabric must be a quality upholstery material. Fairfield reserves the right to reject any material that does not meet our standards. We will not be responsible for defective fabric.
- Proper identification of COM/COL is imperative. If we are unable to identify a COM/COL, or the required amount of the fabric is not received, the order cannot be processed and the anticipated ship date will be delayed.
- Include COM form with COM/COL marked with your company name, and the frame number you are ordering. Please include Fairfield PO number or Fabric PO number.

Shipping address for COM/COL:

Fairfield Chair, Attn: COM Department
606 Kincaid Circle SW
Lenoir, NC 28645

Please copy and complete the COM/COL form located in this price list or website and include it with each piece of COM/COL in your shipment.

Flammability: It is the responsibility of the customer to advise Fairfield Chair Company of local fire code requirements for final shipping destinations at the time of order placement. Further, it is the responsibility of the customer to have on file the California Technical Bulletin 117-2013, NFPA 260A-86 compliance for all COM fabrics. All Fairfield Chair upholstered products meet or exceed the requirements of the California Technical Bulletin 117-2013, NFPA 260A-86 and Upholstered Furniture Action Council (UFAC) for flammability when upholstered with textiles that meet or exceed the same flammability requirements.

NOTE: Fabrics with more than 40% silk content will not be accepted. All fabrics containing silk, or silk-like fabrics must have a knit backing. No silk, or silk-like, fabrics will be entered into production without a knit backing.

Customer's Own Material (COM) and Customer's Own Leather (COL) (continued)

Railroad - RR

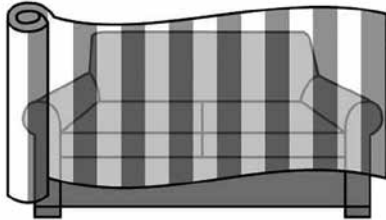

Up the Roll - UTR (same as Non-Railroad, In & Out, Up the Bolt)

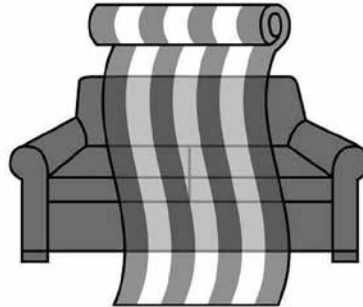

Based on pattern repeat, reference the chart below and add the respective percentage to the price list yardage requirement for COM. For pattern repeats over 30 inches, please contact the factory for yardage requirements. Add Horizontal & Vertical together to get total repeat.

Fabric Width	Plain to 6"	6" to 14"	15" to 20"	21" to 27"	Over 27"*
54"	10%	20%	25%	30%	50%
52" - 53"	25%	35%	40%	45%	60%

NOTE: Fairfield is unable to accept COM fabrics that are **less** than 52 inches wide and **wider** than 60 inches.

STEP 1 COM Yardage Quote

Submit yardage details with the below information to yardagequotes@fairfieldchair.com

- Frame Number and Quantity
- Fabric Mill Name & Pattern
- Fabric Repeat / Fabric Width
- Fabric Placement

STEP 2 Complete COM form

The COM form can be found on the next page or at fairfieldchair.com/resources. Once the form is completed, submit the completed form with the corresponding purchase order (P.O.)

STEP 3 Submit COM form with P.O.

COM YARDAGE QUOTE FORM

Send COM Yardage Quote Request to yardagequotes@fairfieldchair.com

QUOTE DATE # _____
COM Yardage Quote Form with quote number MUST be returned with order and included with COM

Fabric Application

QUOTE REQUEST DATE: _____

DEALER NAME: _____ ACCOUNT #: _____

CONTACT NAME: _____ EMAIL: _____

SALES REP: _____ JOB/PO#: _____

FRAME STYLE: _____ QTY: _____

Railroaded

In & Out

(same as Non-Railroad, In & Out equals Up the Bolt)

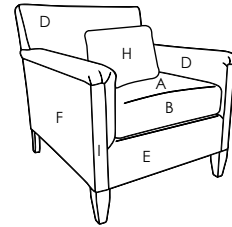
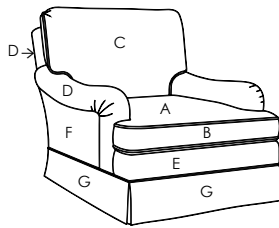
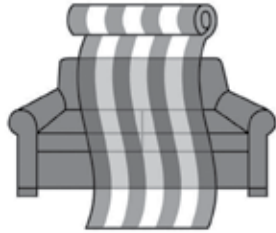
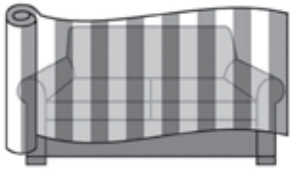

Fabric Placement

- A Seat Cushion Top/Bottom
- B Seat Cushion Boxing
- C Back Pillow Front/Back
- D Inside Arm/Back
- E Platform
- F Outside Arm/Back
- G Skirt
- H Accent Throw Pillows
- I Arm Panel

Based on pattern repeat, add the following percentage to the price list yardage requirement for COM, up to 10 frames:

Fabric Width	Plain to 6"	6" to 14"	15" to 20"	21" to 27"	Over 27"
54"	10%	20%	25%	30%	50%
52" - 53"	25%	35%	40%	45%	60%

- Add Horizontal & Vertical together to get total repeat.
- Fairfield is unable to accept COM/FOM fabrics that are **less** than 52" wide and that are **wider** than 60".

Please do not assume that fabric application is obvious. Attach a sample of your fabric in the space provided, paying careful attention to the top of the pattern and the face side of the fabric. Stripes will be applied vertically, unless otherwise noted. Also, please provide application instructions in the space provided (below).

Note: All COM fabrics must have backing. If backing is not included, fabric will be rejected. We will contact you for resolution.

To have excess yardage returned to you, please include your (check one)
FedEx or **UPS** account number here: _____

Shipping address for COM/COL:

Fairfield Chair / Attn: COM Department, 606 Kincaid Circle SW, Lenoir, NC 28645

All packages should be marked with customer's name, customer's order number and items to be covered.

Special Application Instructions (i.e. specific motifs to center on cushions)

If no instructions are given, then application will be up to factory discretion. _____

If more than three fabrics are requested on a style, Fairfield requires a tearsheet that shows the location of each fabric.

FABRIC 1:				
Mill Name / Pattern / Color _____		Should Your Stripe Run: Vertical? _____ or Horizontal? _____		
Placement (Inback, Outback, Seat Cushion, In Arm, Out Arm, Platform, etc.) _____	Fabric Width _____	Horizontal Repeat _____	Vertical Repeat _____	Yards Needed _____

FABRIC 2:				
Mill Name / Pattern / Color _____		Should Your Stripe Run: Vertical? _____ or Horizontal? _____		
Placement (Inback, Outback, Seat Cushion, In Arm, Out Arm, Platform, etc.) _____	Fabric Width _____	Horizontal Repeat _____	Vertical Repeat _____	Yards Needed _____

FABRIC 3:				
Mill Name / Pattern / Color _____		Should Your Stripe Run: Vertical? _____ or Horizontal? _____		
Placement (Inback, Outback, Seat Cushion, In Arm, Out Arm, Platform, etc.) _____	Fabric Width _____	Horizontal Repeat _____	Vertical Repeat _____	Yards Needed _____

UP Attach Fabric Sample Here **FACE SIDE OUT**

Fabric 1

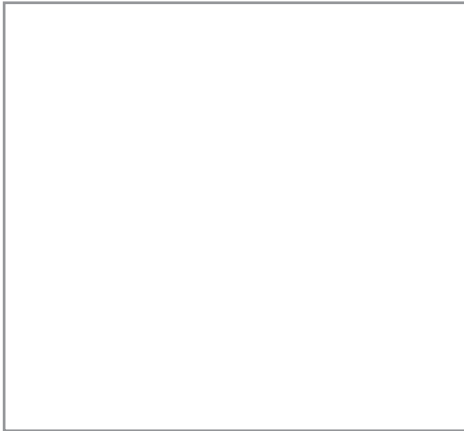

Fabric 2

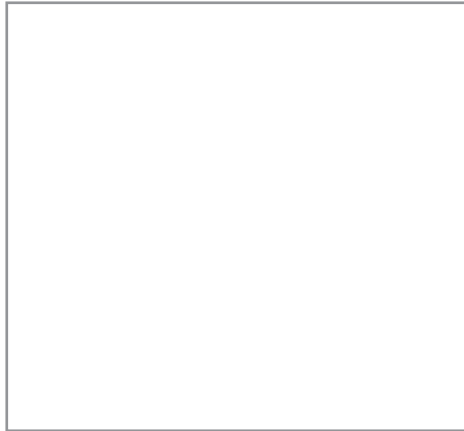

Fabric 3

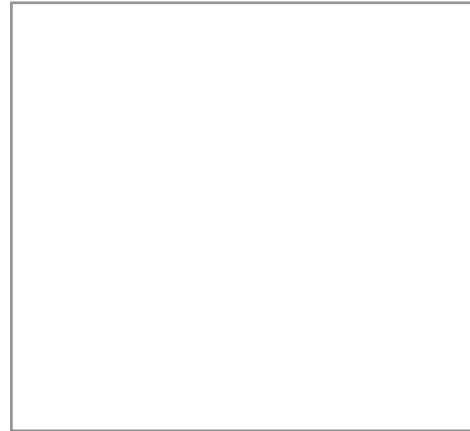

- California Technical Bulletin 117-2013 is a mandatory flammability standard for component materials used to make upholstered furniture.

ENTRÉE DINING

Armless Stack Chairs



5 back shape choices

2 back tailoring options

2 back heights

3 stocked wood finish options

40+ custom wood finish options

	Finish Options	Stocked Finish: Linen	Stocked Finish: Mica	Stocked Finish: Tobacco
Fabric Styles	XXXX-14	XXXX-14-L	XXXX-14-M	XXXX-14-T
Leather Styles	L-XXXX-14	L-XXXX-14-L	L-XXXX-14-M	L-XXXX-14-T

Plain Back

Button Back

Concave Back

- Available in fabric or leather (L-prefix).
- Choose from 40+ wood finish options or three stocked finishes.
- Optional small nailhead trim available on base.



Concave Short Back
w19.5 d27 **h36.5 in.**



Concave Tall Back
w19.5 d27 **h40.5 in.**



1200-14
1200-14-L
1200-14-M
1200-14-T



1204-14
1204-14-L
1204-14-M
1204-14-T



1202-14
1202-14-L
1202-14-M
1202-14-T



1206-14
1206-14-L
1206-14-M
1206-14-T

Camel Back

- Available in fabric or leather (L- prefix).
- Choose from 40+ wood finish options or three stocked finishes.
- Optional small nailhead trim available on base.



Camel Short Back
w19.5 d27 **h37.5 in.**



Camel Tall Back
w19.5 d27 **h41.5 in.**



1220-14
1220-14-L
1220-14-M
1220-14-T



1224-14
1224-14-L
1224-14-M
1224-14-T



1222-14
1222-14-L
1222-14-M
1222-14-T



1226-14
1226-14-L
1226-14-M
1226-14-T

Straight Back

- Available in fabric or leather (L- prefix).
- Choose from 40+ wood finish options or three stocked finishes.
- Optional small nailhead trim available on base.



Straight Short Back
w19.5 d27 **h36.5 in.**



Straight Tall Back
w19.5 d27 **h40.5 in.**



1210-14
1210-14-L
1210-14-M
1210-14-T



1214-14
1214-14-L
1214-14-M
1214-14-T



1212-14
1212-14-L
1212-14-M
1212-14-T



1216-14
1216-14-L
1216-14-M
1216-14-T

Note: Stacking more than three chairs high is not recommended.

FAIRFIELD®

Upholstery Wood Finish Options

Plain Back Button Back

Empire Back

- Available in fabric or leather (L- prefix).
- Choose from 40+ wood finish options or three stocked finishes.
- Standard with small nailhead trim on inback and base.



Pull Back

- Available in fabric or leather (L- prefix).
- Choose from 40+ wood finish options or three stocked finishes for legs and wooden pull.
- Optional small nailhead trim available on base.



 Shown: 1210-14-M Straight Short Back Armless Stack Chair

Note: Stacking more than three chairs high is not recommended.

Collection:		Entree Dining		Entree Dining		Entree Dining	
Name:		Concave Short Back Armless Stack Chair		Concave Short Back Armless Stack Chair		Concave Short Back Armless Stack Chair with Buttons	
		Finish Options		Stocked Finishes		Finish Options	
Sku Options:		Fabric Style	Leather Style	Fabric Style	Leather Style	Fabric Style	Leather Style
		1200-14	L-1200-14	1200-14-L	L-1200-14-L	1202-14	L-1202-14
				1200-14-M	L-1200-14-M		
				1200-14-T	L-1200-14-T		
Overall Dimensions	Width	19.5		19.5		19.5	
	Depth	27		27		27	
	Height	36.5		36.5		36.5	
	Seat Height:	20		20		20	
	Seat Depth:	19		19		19	
	Inside Width:	19.5		19.5		19.5	
Wrap , Carton Weight, Cubes		22 , 22 , 11.12		22 , 22 , 11.12		22 , 22 , 11.12	
		Fabric	Leather	Fabric	Leather	Fabric	Leather
Grade D / Leather 1		\$1,077	\$1,737	\$897	\$1,557	\$1,107	\$1,767
Grade E / Leather 2		\$1,086	\$1,827	\$906	\$1,647	\$1,116	\$1,857
Grade F / Leather 3		\$1,095	\$1,917	\$915	\$1,737	\$1,125	\$1,947
Grade G / Leather 4		\$1,104	\$2,007	\$924	\$1,827	\$1,134	\$2,037
Grade H / Leather 5		\$1,095	\$2,097	\$915	\$1,917	\$1,125	\$2,127
Grade J / Leather 6		\$1,104	\$2,187	\$924	\$2,007	\$1,134	\$2,217
Grade K (COM)		\$1,113		\$933		\$1,143	
Grade L / Leather 8		\$1,122	\$2,982	\$942	\$2,802	\$1,152	\$3,012
Grade M (COL)		\$1,077		\$897		\$1,107	
Grade N		\$1,086		\$906		\$1,116	
Grade O		\$1,095		\$915		\$1,125	
Grade P		\$1,104		\$924		\$1,134	
Grade Q		\$1,095		\$915		\$1,125	
Grade R		\$1,104		\$924		\$1,134	
Grade S		\$1,113		\$933		\$1,143	
Grade T		\$1,122		\$942		\$1,152	
Grade U		\$1,113		\$933		\$1,143	
U+ Formula (See pg.12)		(# above U) x 9 + 1113		(# above U) x 9 + 933		(# above U) x 9 + 1143	
RISER		9		9		9	
COM (Yards)		2.75		2.75		2.75	
COL (sq. ft.)			57		57		57
Standard Seat Cushion:		High Resiliency 40		High Resiliency 40		High Resiliency 40	
Finish Options:		Y		N		Y	
Nail-head Trim:	Small	45	45	45	45	45	45
	Medium	N/A	N/A	N/A	N/A	N/A	N/A

Collection:		Entree Dining		Entree Dining		Entree Dining	
Name:		Concave Short Back Armless Stack Chair with Buttons		Concave Tall Back Armless Stack Chair		Concave Tall Back Armless Stack Chair	
Sku Options:		Stocked Finishes		Finish Options		Stocked Finishes	
		Fabric Style	Leather Style	Fabric Style	Leather Style	Fabric Style	Leather Style
		1202-14-L	L-1202-14-L	1204-14	L-1204-14	1204-14-L	L-1204-14-L
		1202-14-M	L-1202-14-M			1204-14-M	L-1204-14-M
		1202-14-T	L-1202-14-T			1204-14-T	L-1204-14-T
Overall Dimensions	Width	19.5		19.5		19.5	
	Depth	27		27		27	
	Height	36.5		40.5		40.5	
Seat Height:		20		20		20	
Seat Depth:		19		19		19	
Inside Width:		19.5		19.5		19.5	
Wrap, Carton Weight, Cubes		22, 22, 11.12		22, 22, 12.33		22, 22, 12.33	
		Fabric	Leather	Fabric	Leather	Fabric	Leather
Grade D / Leather 1		\$927	\$1,587	\$1,077	\$1,737	\$897	\$1,557
Grade E / Leather 2		\$936	\$1,677	\$1,086	\$1,827	\$906	\$1,647
Grade F / Leather 3		\$945	\$1,767	\$1,095	\$1,917	\$915	\$1,737
Grade G / Leather 4		\$954	\$1,857	\$1,104	\$2,007	\$924	\$1,827
Grade H / Leather 5		\$945	\$1,947	\$1,095	\$2,097	\$915	\$1,917
Grade J / Leather 6		\$954	\$2,037	\$1,104	\$2,187	\$924	\$2,007
Grade K (COM)		\$963		\$1,113		\$933	
Grade L / Leather 8		\$972	\$2,832	\$1,122	\$2,982	\$942	\$2,802
Grade M (COL)		\$927		\$1,077		\$897	
Grade N		\$936		\$1,086		\$906	
Grade O		\$945		\$1,095		\$915	
Grade P		\$954		\$1,104		\$924	
Grade Q		\$945		\$1,095		\$915	
Grade R		\$954		\$1,104		\$924	
Grade S		\$963		\$1,113		\$933	
Grade T		\$972		\$1,122		\$942	
Grade U		\$963		\$1,113		\$933	
U+ Formula (See pg.12)		(# above U) x 9 + 963		(# above U) x 9 + 1113		(# above U) x 9 + 933	
RISER		9		9		9	
COM (Yards)		2.75		2.75		2.75	
COL (sq. ft.)		57		57		57	
Standard Seat Cushion:		High Resiliency 40		High Resiliency 40		High Resiliency 40	
Finish Options:		N		Y		N	
Nail-head Trim:	Small	45	45	45	45	45	45
	Medium	N/A	N/A	N/A	N/A	N/A	N/A

Collection:		Entree Dining		Entree Dining		Entree Dining	
Name:		Concave Tall Back Armless Stack Chair with Buttons		Concave Tall Back Armless Stack Chair with Buttons		Straight Short Back Armless Stack Chair	
Sku Options:		Finish Options		Stocked Finishes		Finish Options	
		Fabric Style	Leather Style	Fabric Style	Leather Style	Fabric Style	Leather Style
		1206-14	L-1206-14	1206-14-L 1206-14-M 1206-14-T	L-1206-14-L L-1206-14-M L-1206-14-T	1210-14	L-1210-14
Overall Dimensions	Width	19.5		19.5		19.5	
	Depth	27		27		27	
	Height	40.5		40.5		36.5	
	Seat Height:	20		20		20	
	Seat Depth:	19		19		19	
	Inside Width:	19.5		19.5		19.5	
Wrap , Carton Weight, Cubes		22 , 22 , 12.33		22 , 22 , 12.33		22 , 22 , 11.12	
		Fabric	Leather	Fabric	Leather	Fabric	Leather
Grade D / Leather 1		\$1,107	\$1,767	\$927	\$1,587	\$1,077	\$1,737
Grade E / Leather 2		\$1,116	\$1,857	\$936	\$1,677	\$1,086	\$1,827
Grade F / Leather 3		\$1,125	\$1,947	\$945	\$1,767	\$1,095	\$1,917
Grade G / Leather 4		\$1,134	\$2,037	\$954	\$1,857	\$1,104	\$2,007
Grade H / Leather 5		\$1,125	\$2,127	\$945	\$1,947	\$1,095	\$2,097
Grade J / Leather 6		\$1,134	\$2,217	\$954	\$2,037	\$1,104	\$2,187
Grade K (COM)		\$1,143		\$963		\$1,113	
Grade L / Leather 8		\$1,152	\$3,012	\$972	\$2,832	\$1,122	\$2,982
Grade M (COL)		\$1,107		\$927		\$1,077	
Grade N		\$1,116		\$936		\$1,086	
Grade O		\$1,125		\$945		\$1,095	
Grade P		\$1,134		\$954		\$1,104	
Grade Q		\$1,125		\$945		\$1,095	
Grade R		\$1,134		\$954		\$1,104	
Grade S		\$1,143		\$963		\$1,113	
Grade T		\$1,152		\$972		\$1,122	
Grade U		\$1,143		\$963		\$1,113	
U+ Formula (See pg.12)		(# above U) x 9 + 1143		(# above U) x 9 + 963		(# above U) x 9 + 1113	
RISER		9		9		9	
COM (Yards)		2.75		2.75		2.75	
COL (sq. ft.)			57		57		57
Standard Seat Cushion:		High Resiliency 40		High Resiliency 40		High Resiliency 40	
Finish Options:		Y		N		Y	
Nail-head Trim:	Small	45	45	45	45	45	45
	Medium	N/A	N/A	N/A	N/A	N/A	N/A

Collection:		Entree Dining		Entree Dining		Entree Dining	
Name:		Straight Short Back Armless Stack Chair		Straight Short Back Armless Stack Chair with Buttons		Straight Short Back Armless Stack Chair with Buttons	
Sku Options:		Stocked Finishes		Finish Options		Stocked Finishes	
		Fabric Style	Leather Style	Fabric Style	Leather Style	Fabric Style	Leather Style
		1210-14-L	L-1210-14-L	1212-14	L-1212-14	1212-14-L	L-1212-14-L
		1210-14-M	L-1210-14-M			1212-14-M	L-1212-14-M
		1210-14-T	L-1210-14-T			1212-14-T	L-1212-14-T
Overall Dimensions	Width	19.5		19.5		19.5	
	Depth	27		27		27	
	Height	36.5		36.5		36.5	
Seat Height:		20		20		20	
Seat Depth:		19		19		19	
Inside Width:		19.5		19.5		19.5	
Wrap, Carton Weight, Cubes		22, 22, 11.12		22, 22, 11.12		22, 22, 11.12	
		Fabric	Leather	Fabric	Leather	Fabric	Leather
Grade D / Leather 1		\$897	\$1,557	\$1,107	\$1,767	\$927	\$1,587
Grade E / Leather 2		\$906	\$1,647	\$1,116	\$1,857	\$936	\$1,677
Grade F / Leather 3		\$915	\$1,737	\$1,125	\$1,947	\$945	\$1,767
Grade G / Leather 4		\$924	\$1,827	\$1,134	\$2,037	\$954	\$1,857
Grade H / Leather 5		\$915	\$1,917	\$1,125	\$2,127	\$945	\$1,947
Grade J / Leather 6		\$924	\$2,007	\$1,134	\$2,217	\$954	\$2,037
Grade K (COM)		\$933		\$1,143		\$963	
Grade L / Leather 8		\$942	\$2,802	\$1,152	\$3,012	\$972	\$2,832
Grade M (COL)		\$897		\$1,107		\$927	
Grade N		\$906		\$1,116		\$936	
Grade O		\$915		\$1,125		\$945	
Grade P		\$924		\$1,134		\$954	
Grade Q		\$915		\$1,125		\$945	
Grade R		\$924		\$1,134		\$954	
Grade S		\$933		\$1,143		\$963	
Grade T		\$942		\$1,152		\$972	
Grade U		\$933		\$1,143		\$963	
U+ Formula (See pg.12)		(# above U) x 9 + 933		(# above U) x 9 + 1143		(# above U) x 9 + 963	
RISER		9		9		9	
COM (Yards)		2.75		2.75		2.75	
COL (sq. ft.)		57		57		57	
Standard Seat Cushion:		High Resiliency 40		High Resiliency 40		High Resiliency 40	
Finish Options:		N		Y		N	
Nail-head Trim:	Small	45	45	45	45	45	45
	Medium	N/A	N/A	N/A	N/A	N/A	N/A

Collection:		Entree Dining		Entree Dining		Entree Dining	
Name:		Straight Tall Back Armless Stack Chair		Straight Tall Back Armless Stack Chair		Straight Tall Back Armless Stack Chair with Buttons	
		Finish Options		Stocked Finishes		Finish Options	
Sku Options:		Fabric Style	Leather Style	Fabric Style	Leather Style	Fabric Style	Leather Style
		1214-14	L-1214-14	1214-14-L	L-1214-14-L	1216-14	L-1216-14
				1214-14-M	L-1214-14-M		
				1214-14-T	L-1214-14-T		
Overall Dimensions	Width	19.5		19.5		19.5	
	Depth	27		27		27	
	Height	40.5		40.5		40.5	
	Seat Height:	20		20		20	
	Seat Depth:	19		19		19	
	Inside Width:	19.5		19.5		19.5	
Wrap, Carton Weight, Cubes		22, 22, 12.33		22, 22, 12.33		22, 22, 12.33	
		Fabric	Leather	Fabric	Leather	Fabric	Leather
Grade D / Leather 1		\$1,077	\$1,737	\$897	\$1,557	\$1,107	\$1,767
Grade E / Leather 2		\$1,086	\$1,827	\$906	\$1,647	\$1,116	\$1,857
Grade F / Leather 3		\$1,095	\$1,917	\$915	\$1,737	\$1,125	\$1,947
Grade G / Leather 4		\$1,104	\$2,007	\$924	\$1,827	\$1,134	\$2,037
Grade H / Leather 5		\$1,095	\$2,097	\$915	\$1,917	\$1,125	\$2,127
Grade J / Leather 6		\$1,104	\$2,187	\$924	\$2,007	\$1,134	\$2,217
Grade K (COM)		\$1,113		\$933		\$1,143	
Grade L / Leather 8		\$1,122	\$2,982	\$942	\$2,802	\$1,152	\$3,012
Grade M (COL)		\$1,077		\$897		\$1,107	
Grade N		\$1,086		\$906		\$1,116	
Grade O		\$1,095		\$915		\$1,125	
Grade P		\$1,104		\$924		\$1,134	
Grade Q		\$1,095		\$915		\$1,125	
Grade R		\$1,104		\$924		\$1,134	
Grade S		\$1,113		\$933		\$1,143	
Grade T		\$1,122		\$942		\$1,152	
Grade U		\$1,113		\$933		\$1,143	
U+ Formula (See pg.12)		(# above U) x 9 + 1113		(# above U) x 9 + 933		(# above U) x 9 + 1143	
RISER		9		9		9	
COM (Yards)		2.75		2.75		2.75	
COL (sq. ft.)		57		57		57	
Standard Seat Cushion:		High Resiliency 40		High Resiliency 40		High Resiliency 40	
Finish Options:		Y		N		Y	
Nail-head Trim:	Small	45	45	45	45	45	45
	Medium	N/A	N/A	N/A	N/A	N/A	N/A

Collection:		Entree Dining		Entree Dining		Entree Dining	
Name:		Straight Tall Back Armless Stack Chair with Buttons		Camel Short Back Armless Stack Chair		Camel Short Back Armless Stack Chair	
SKU Options:		Stocked Finishes		Finish Options		Stocked Finishes	
		Fabric Style	Leather Style	Fabric Style	Leather Style	Fabric Style	Leather Style
		1216-14-L	L-1216-14-L	1220-14	L-1220-14	1220-14-L	L-1220-14-L
		1216-14-M	L-1216-14-M			1220-14-M	L-1220-14-M
		1216-14-T	L-1216-14-T			1220-14-T	L-1220-14-T
Overall Dimensions	Width	19.5		19.5		19.5	
	Depth	27		27		27	
	Height	40.5		37.5		37.5	
Seat Height:		20		20		20	
Seat Depth:		19		19		19	
Inside Width:		19.5		19.5		19.5	
Wrap, Carton Weight, Cubes		22, 22, 12.33		22, 22, 11.42		22, 22, 11.42	
		Fabric	Leather	Fabric	Leather	Fabric	Leather
Grade D / Leather 1		\$927	\$1,587	\$1,077	\$1,737	\$897	\$1,557
Grade E / Leather 2		\$936	\$1,677	\$1,086	\$1,827	\$906	\$1,647
Grade F / Leather 3		\$945	\$1,767	\$1,095	\$1,917	\$915	\$1,737
Grade G / Leather 4		\$954	\$1,857	\$1,104	\$2,007	\$924	\$1,827
Grade H / Leather 5		\$945	\$1,947	\$1,095	\$2,097	\$915	\$1,917
Grade J / Leather 6		\$954	\$2,037	\$1,104	\$2,187	\$924	\$2,007
Grade K (COM)		\$963		\$1,113		\$933	
Grade L / Leather 8		\$972	\$2,832	\$1,122	\$2,982	\$942	\$2,802
Grade M (COL)		\$927		\$1,077		\$897	
Grade N		\$936		\$1,086		\$906	
Grade O		\$945		\$1,095		\$915	
Grade P		\$954		\$1,104		\$924	
Grade Q		\$945		\$1,095		\$915	
Grade R		\$954		\$1,104		\$924	
Grade S		\$963		\$1,113		\$933	
Grade T		\$972		\$1,122		\$942	
Grade U		\$963		\$1,113		\$933	
U+ Formula (See pg.12)		(# above U) x 9 + 963		(# above U) x 9 + 1113		(# above U) x 9 + 933	
RISER		9		9		9	
COM (Yards)		2.75		2.75		2.75	
COL (sq. ft.)			57		57		57
Standard Seat Cushion:		High Resiliency 40		High Resiliency 40		High Resiliency 40	
Finish Options:		N		Y		N	
Nail-head Trim:	Small	45	45	45	45	45	45
	Medium	N/A	N/A	N/A	N/A	N/A	N/A

Collection:		Entree Dining		Entree Dining		Entree Dining	
Name:	Camel Short Back Armless Stack Chair with Buttons		Camel Short Back Armless Stack Chair with Buttons		Camel Tall Back Armless Stack Chair		
	Finish Options		Stocked Finishes		Finish Options		
Sku Options:	Fabric Style	Leather Style	Fabric Style	Leather Style	Fabric Style	Leather Style	
	1222-14	L-1222-14	1222-14-L	L-1222-14-L	1224-14	L-1224-14	
			1222-14-M	L-1222-14-M			
			1222-14-T	L-1222-14-T			
Overall Dimensions	Width	19.5		19.5		19.5	
	Depth	27		27		27	
	Height	37.5		37.5		41.5	
	Seat Height:	20		20		20	
	Seat Depth:	19		19		19	
	Inside Width:	19.5		19.5		19.5	
Wrap, Carton Weight, Cubes		22, 22, 11.42		22, 22, 11.42		22, 22, 12.64	
		Fabric	Leather	Fabric	Leather	Fabric	Leather
Grade D / Leather 1		\$1,107	\$1,767	\$927	\$1,587	\$1,077	\$1,737
Grade E / Leather 2		\$1,116	\$1,857	\$936	\$1,677	\$1,086	\$1,827
Grade F / Leather 3		\$1,125	\$1,947	\$945	\$1,767	\$1,095	\$1,917
Grade G / Leather 4		\$1,134	\$2,037	\$954	\$1,857	\$1,104	\$2,007
Grade H / Leather 5		\$1,125	\$2,127	\$945	\$1,947	\$1,095	\$2,097
Grade J / Leather 6		\$1,134	\$2,217	\$954	\$2,037	\$1,104	\$2,187
Grade K (COM)		\$1,143		\$963		\$1,113	
Grade L / Leather 8		\$1,152	\$3,012	\$972	\$2,832	\$1,122	\$2,982
Grade M (COL)		\$1,107		\$927		\$1,077	
Grade N		\$1,116		\$936		\$1,086	
Grade O		\$1,125		\$945		\$1,095	
Grade P		\$1,134		\$954		\$1,104	
Grade Q		\$1,125		\$945		\$1,095	
Grade R		\$1,134		\$954		\$1,104	
Grade S		\$1,143		\$963		\$1,113	
Grade T		\$1,152		\$972		\$1,122	
Grade U		\$1,143		\$963		\$1,113	
U+ Formula (See pg.12)		(# above U) x 9 + 1143		(# above U) x 9 + 963		(# above U) x 9 + 1113	
RISER		9		9		9	
COM (Yards)		2.75		2.75		2.75	
COL (sq. ft.)		57		57		57	
Standard Seat Cushion:		High Resiliency 40		High Resiliency 40		High Resiliency 40	
Finish Options:		Y		N		Y	
Nail-head Trim:	Small	45	45	45	45	45	45
	Medium	N/A	N/A	N/A	N/A	N/A	N/A

Collection:		Entree Dining		Entree Dining		Entree Dining	
Name:		Camel Tall Back Armless Stack Chair		Camel Tall Back Armless Stack Chair with Buttons		Camel Tall Back Armless Stack Chair with Buttons	
Sku Options:		Stocked Finishes		Finish Options		Stocked Finishes	
		Fabric Style	Leather Style	Fabric Style	Leather Style	Fabric Style	Leather Style
		1224-14-L	L-1224-14-L	1226-14	L-1226-14	1226-14-L	L-1226-14-L
		1224-14-M	L-1224-14-M			1226-14-M	L-1226-14-M
		1224-14-T	L-1224-14-T			1226-14-T	L-1226-14-T
Overall Dimensions	Width	19.5		19.5		19.5	
	Depth	27		27		27	
	Height	41.5		41.5		41.5	
	Seat Height:	20		20		20	
	Seat Depth:	19		19		19	
	Inside Width:	19.5		19.5		19.5	
Wrap, Carton Weight, Cubes		22, 22, 12.64		22, 22, 12.64		22, 22, 12.64	
		Fabric	Leather	Fabric	Leather	Fabric	Leather
Grade D / Leather 1		\$897	\$1,557	\$1,107	\$1,767	\$927	\$1,587
Grade E / Leather 2		\$906	\$1,647	\$1,116	\$1,857	\$936	\$1,677
Grade F / Leather 3		\$915	\$1,737	\$1,125	\$1,947	\$945	\$1,767
Grade G / Leather 4		\$924	\$1,827	\$1,134	\$2,037	\$954	\$1,857
Grade H / Leather 5		\$915	\$1,917	\$1,125	\$2,127	\$945	\$1,947
Grade J / Leather 6		\$924	\$2,007	\$1,134	\$2,217	\$954	\$2,037
Grade K (COM)		\$933		\$1,143		\$963	
Grade L / Leather 8		\$942	\$2,802	\$1,152	\$3,012	\$972	\$2,832
Grade M (COL)		\$897		\$1,107		\$927	
Grade N		\$906		\$1,116		\$936	
Grade O		\$915		\$1,125		\$945	
Grade P		\$924		\$1,134		\$954	
Grade Q		\$915		\$1,125		\$945	
Grade R		\$924		\$1,134		\$954	
Grade S		\$933		\$1,143		\$963	
Grade T		\$942		\$1,152		\$972	
Grade U		\$933		\$1,143		\$963	
U+ Formula (See pg.12)		(# above U) x 9 + 933		(# above U) x 9 + 1143		(# above U) x 9 + 963	
RISER		9		9		9	
COM (Yards)		2.75		2.75		2.75	
COL (sq. ft.)		57		57		57	
Standard Seat Cushion:		High Resiliency 40		High Resiliency 40		High Resiliency 40	
Finish Options:		N		Y		N	
Nail-head Trim:	Small	45	45	45	45	45	45
	Medium	N/A	N/A	N/A	N/A	N/A	N/A

Collection:		Entree Dining		Entree Dining		Entree Dining	
Name:		Pull Short Back Armless Stack Chair		Pull Short Back Armless Stack Chair		Pull Short Back Armless Stack Chair with Buttons	
Sku Options:		Finish Options		Stocked Finishes		Finish Options	
		Fabric Style	Leather Style	Fabric Style	Leather Style	Fabric Style	Leather Style
		1230-14	L-1230-14	1230-14-L 1230-14-M 1230-14-T	L-1230-14-L L-1230-14-M L-1230-14-T	1232-14	L-1232-14
Overall Dimensions	Width	19.5		19.5		19.5	
	Depth	27		27		27	
	Height	36.5		36.5		36.5	
	Seat Height:	20		20		20	
	Seat Depth:	19		19		19	
	Inside Width:	19.5		19.5		19.5	
Wrap, Carton Weight, Cubes		22, 22, 11.12		22, 22, 11.12		22, 22, 11.12	
		Fabric	Leather	Fabric	Leather	Fabric	Leather
Grade D / Leather 1		\$1,107	\$1,767	\$927	\$1,587	\$1,137	\$1,797
Grade E / Leather 2		\$1,116	\$1,857	\$936	\$1,677	\$1,146	\$1,887
Grade F / Leather 3		\$1,125	\$1,947	\$945	\$1,767	\$1,155	\$1,977
Grade G / Leather 4		\$1,134	\$2,037	\$954	\$1,857	\$1,164	\$2,067
Grade H / Leather 5		\$1,125	\$2,127	\$945	\$1,947	\$1,155	\$2,157
Grade J / Leather 6		\$1,134	\$2,217	\$954	\$2,037	\$1,164	\$2,247
Grade K (COM)		\$1,143		\$963		\$1,173	
Grade L / Leather 8		\$1,152	\$3,012	\$972	\$2,832	\$1,182	\$3,042
Grade M (COL)		\$1,107		\$927		\$1,137	
Grade N		\$1,116		\$936		\$1,146	
Grade O		\$1,125		\$945		\$1,155	
Grade P		\$1,134		\$954		\$1,164	
Grade Q		\$1,125		\$945		\$1,155	
Grade R		\$1,134		\$954		\$1,164	
Grade S		\$1,143		\$963		\$1,173	
Grade T		\$1,152		\$972		\$1,182	
Grade U		\$1,143		\$963		\$1,173	
U+ Formula (See pg.12)		(# above U) x 9 + 1143		(# above U) x 9 + 963		(# above U) x 9 + 1173	
RISER		9		9		9	
COM (Yards)		2.75		2.75		2.75	
COL (sq. ft.)			57		57		57
Standard Seat Cushion:		High Resiliency 40		High Resiliency 40		High Resiliency 40	
Finish Options:		Y		N		Y	
Nail-head Trim:	Small	45	45	45	45	45	45
	Medium	N/A	N/A	N/A	N/A	N/A	N/A

Collection:		Entree Dining		Entree Dining		Entree Dining	
Name:		Pull Short Back Armless Stack Chair with Buttons		Pull Tall Back Armless Stack Chair		Pull Tall Back Armless Stack Chair	
SKU Options:		Stocked Finishes		Finish Options		Stocked Finishes	
		Fabric Style	Leather Style	Fabric Style	Leather Style	Fabric Style	Leather Style
		1232-14-L	L-1232-14-L	1234-14	L-1234-14	1234-14-L	L-1234-14-L
		1232-14-M	L-1232-14-M			1234-14-M	L-1234-14-M
		1232-14-T	L-1232-14-T			1234-14-T	L-1234-14-T
Overall Dimensions	Width	19.5		19.5		19.5	
	Depth	27		27		27	
	Height	36.5		40.5		40.5	
Seat Height:		20		20		20	
Seat Depth:		19		19		19	
Inside Width:		19.5		19.5		19.5	
Wrap, Carton Weight, Cubes		22, 22, 11.12		22, 22, 12.33		22, 22, 12.33	
		Fabric	Leather	Fabric	Leather	Fabric	Leather
Grade D / Leather 1		\$957	\$1,617	\$1,107	\$1,767	\$927	\$1,587
Grade E / Leather 2		\$966	\$1,707	\$1,116	\$1,857	\$936	\$1,677
Grade F / Leather 3		\$975	\$1,797	\$1,125	\$1,947	\$945	\$1,767
Grade G / Leather 4		\$984	\$1,887	\$1,134	\$2,037	\$954	\$1,857
Grade H / Leather 5		\$975	\$1,977	\$1,125	\$2,127	\$945	\$1,947
Grade J / Leather 6		\$984	\$2,067	\$1,134	\$2,217	\$954	\$2,037
Grade K (COM)		\$993		\$1,143		\$963	
Grade L / Leather 8		\$1,002	\$2,862	\$1,152	\$3,012	\$972	\$2,832
Grade M (COL)		\$957		\$1,107		\$927	
Grade N		\$966		\$1,116		\$936	
Grade O		\$975		\$1,125		\$945	
Grade P		\$984		\$1,134		\$954	
Grade Q		\$975		\$1,125		\$945	
Grade R		\$984		\$1,134		\$954	
Grade S		\$993		\$1,143		\$963	
Grade T		\$1,002		\$1,152		\$972	
Grade U		\$993		\$1,143		\$963	
U+ Formula (See pg.12)		(# above U) x 9 + 993		(# above U) x 9 + 1143		(# above U) x 9 + 963	
RISER		9		9		9	
COM (Yards)		2.75		2.75		2.75	
COL (sq. ft.)		57		57		57	
Standard Seat Cushion:		High Resiliency 40		High Resiliency 40		High Resiliency 40	
Finish Options:		N		Y		N	
Nail-head Trim:	Small	45	45	45	45	45	45
	Medium	N/A	N/A	N/A	N/A	N/A	N/A

Collection:		Entree Dining		Entree Dining		Entree Dining	
Name:		Pull Tall Back Armless Stack Chair with Buttons		Pull Tall Back Armless Stack Chair with Buttons		Empire Short Back Armless Stack Chair	
Sku Options:		Finish Options		Stocked Finishes		Finish Options	
		Fabric Style	Leather Style	Fabric Style	Leather Style	Fabric Style	Leather Style
		1236-14	L-1236-14	1236-14-L 1236-14-M 1236-14-T	L-1236-14-L L-1236-14-M L-1236-14-T	1240-14	L-1240-14
Overall Dimensions	Width	19.5		19.5		19.5	
	Depth	27		27		27	
	Height	40.5		40.5		38	
	Seat Height:	20		20		20	
	Seat Depth:	19		19		19	
	Inside Width:	19.5		19.5		19.5	
Wrap, Carton Weight, Cubes		22, 22, 12.33		22, 22, 12.33		22, 22, 11.57	
		Fabric	Leather	Fabric	Leather	Fabric	Leather
Grade D / Leather 1		\$1,137	\$1,797	\$957	\$1,617	\$1,107	\$1,767
Grade E / Leather 2		\$1,146	\$1,887	\$966	\$1,707	\$1,116	\$1,857
Grade F / Leather 3		\$1,155	\$1,977	\$975	\$1,797	\$1,125	\$1,947
Grade G / Leather 4		\$1,164	\$2,067	\$984	\$1,887	\$1,134	\$2,037
Grade H / Leather 5		\$1,155	\$2,157	\$975	\$1,977	\$1,125	\$2,127
Grade J / Leather 6		\$1,164	\$2,247	\$984	\$2,067	\$1,134	\$2,217
Grade K (COM)		\$1,173		\$993		\$1,143	
Grade L / Leather 8		\$1,182	\$3,042	\$1,002	\$2,862	\$1,152	\$3,012
Grade M (COL)		\$1,137		\$957		\$1,107	
Grade N		\$1,146		\$966		\$1,116	
Grade O		\$1,155		\$975		\$1,125	
Grade P		\$1,164		\$984		\$1,134	
Grade Q		\$1,155		\$975		\$1,125	
Grade R		\$1,164		\$984		\$1,134	
Grade S		\$1,173		\$993		\$1,143	
Grade T		\$1,182		\$1,002		\$1,152	
Grade U		\$1,173		\$993		\$1,143	
U+ Formula (See pg.12)		(# above U) x 9 + 1173		(# above U) x 9 + 993		(# above U) x 9 + 1143	
RISER		9		9		9	
COM (Yards)		2.75		2.75		2.75	
COL (sq. ft.)			57		57		57
Standard Seat Cushion:		High Resiliency 40		High Resiliency 40		High Resiliency 40	
Finish Options:		Y		N		Y	
Nail-head Trim:	Small	45	45	45	45	Std.	Std.
	Medium	N/A	N/A	N/A	N/A	N/A	N/A

Collection:		Entree Dining		Entree Dining		Entree Dining	
Name:		Empire Short Back Armless Stack Chair		Empire Short Back Armless Stack Chair with Buttons		Empire Short Back Armless Stack Chair with Buttons	
Sku Options:		Stocked Finishes		Finish Options		Stocked Finishes	
		Fabric Style	Leather Style	Fabric Style	Leather Style	Fabric Style	Leather Style
		1240-14-L	L-1240-14-L	1242-14	L-1242-14	1242-14-L	L-1242-14-L
		1240-14-M	L-1240-14-M			1242-14-M	L-1242-14-M
		1240-14-T	L-1240-14-T			1242-14-T	L-1242-14-T
Overall Dimensions	Width	19.5		19.5		19.5	
	Depth	27		27		27	
	Height	38		38		38	
Seat Height:		20		20		20	
Seat Depth:		19		19		19	
Inside Width:		19.5		19.5		19.5	
Wrap, Carton Weight, Cubes		22, 22, 11.57		22, 22, 11.57		22, 22, 11.57	
		Fabric	Leather	Fabric	Leather	Fabric	Leather
Grade D / Leather 1		\$927	\$1,587	\$1,137	\$1,797	\$957	\$1,617
Grade E / Leather 2		\$936	\$1,677	\$1,146	\$1,887	\$966	\$1,707
Grade F / Leather 3		\$945	\$1,767	\$1,155	\$1,977	\$975	\$1,797
Grade G / Leather 4		\$954	\$1,857	\$1,164	\$2,067	\$984	\$1,887
Grade H / Leather 5		\$945	\$1,947	\$1,155	\$2,157	\$975	\$1,977
Grade J / Leather 6		\$954	\$2,037	\$1,164	\$2,247	\$984	\$2,067
Grade K (COM)		\$963		\$1,173		\$993	
Grade L / Leather 8		\$972	\$2,832	\$1,182	\$3,042	\$1,002	\$2,862
Grade M (COL)		\$927		\$1,137		\$957	
Grade N		\$936		\$1,146		\$966	
Grade O		\$945		\$1,155		\$975	
Grade P		\$954		\$1,164		\$984	
Grade Q		\$945		\$1,155		\$975	
Grade R		\$954		\$1,164		\$984	
Grade S		\$963		\$1,173		\$993	
Grade T		\$972		\$1,182		\$1,002	
Grade U		\$963		\$1,173		\$993	
U+ Formula (See pg.12)		(# above U) x 9 + 963		(# above U) x 9 + 1173		(# above U) x 9 + 993	
RISER		9		9		9	
COM (Yards)		2.75		2.75		2.75	
COL (sq. ft.)		57		57		57	
Standard Seat Cushion:		High Resiliency 40		High Resiliency 40		High Resiliency 40	
Finish Options:		N		Y		N	
Nail-head Trim:	Small	Std.	Std.	Std.	Std.	Std.	Std.
	Medium	N/A	N/A	N/A	N/A	N/A	N/A

Collection:		Entree Dining		Entree Dining		Entree Dining	
Name:		Empire Tall Back Armless Stack Chair		Empire Tall Back Armless Stack Chair		Empire Tall Back Armless Stack Chair with Buttons	
Sku Options:		Finish Options		Stocked Finishes		Finish Options	
		Fabric Style	Leather Style	Fabric Style	Leather Style	Fabric Style	Leather Style
		1244-14	L-1244-14	1244-14-L 1244-14-M 1244-14-T	L-1244-14-L L-1244-14-M L-1244-14-T	1246-14	L-1246-14
Overall Dimensions	Width	19.5		19.5		19.5	
	Depth	27		27		27	
	Height	42		42		42	
Seat Height:		20		20		20	
Seat Depth:		19		19		19	
Inside Width:		19.5		19.5		19.5	
Wrap, Carton Weight, Cubes		22, 22, 12.79		22, 22, 12.79		22, 22, 12.79	
		Fabric	Leather	Fabric	Leather	Fabric	Leather
Grade D / Leather 1		\$1,107	\$1,767	\$927	\$1,587	\$1,137	\$1,797
Grade E / Leather 2		\$1,116	\$1,857	\$936	\$1,677	\$1,146	\$1,887
Grade F / Leather 3		\$1,125	\$1,947	\$945	\$1,767	\$1,155	\$1,977
Grade G / Leather 4		\$1,134	\$2,037	\$954	\$1,857	\$1,164	\$2,067
Grade H / Leather 5		\$1,125	\$2,127	\$945	\$1,947	\$1,155	\$2,157
Grade J / Leather 6		\$1,134	\$2,217	\$954	\$2,037	\$1,164	\$2,247
Grade K (COM)		\$1,143		\$963		\$1,173	
Grade L / Leather 8		\$1,152	\$3,012	\$972	\$2,832	\$1,182	\$3,042
Grade M (COL)		\$1,107		\$927		\$1,137	
Grade N		\$1,116		\$936		\$1,146	
Grade O		\$1,125		\$945		\$1,155	
Grade P		\$1,134		\$954		\$1,164	
Grade Q		\$1,125		\$945		\$1,155	
Grade R		\$1,134		\$954		\$1,164	
Grade S		\$1,143		\$963		\$1,173	
Grade T		\$1,152		\$972		\$1,182	
Grade U		\$1,143		\$963		\$1,173	
U+ Formula (See pg.12)		(# above U) x 9 + 1143		(# above U) x 9 + 963		(# above U) x 9 + 1173	
RISER		9		9		9	
COM (Yards)		2.75		2.75		2.75	
COL (sq. ft.)			57		57		57
Standard Seat Cushion:		High Resiliency 40		High Resiliency 40		High Resiliency 40	
Finish Options:		Y		N		Y	
Nail-head Trim:	Small	Std.	Std.	Std.	Std.	Std.	Std.
	Medium	N/A	N/A	N/A	N/A	N/A	N/A

Collection:		Entree Dining	
Name:		Empire Tall Back Armless Stack Chair with Buttons	
Sku Options:		Stocked Finishes	
		Fabric Style	Leather Style
		1246-14-L	L-1246-14-L
		1246-14-M	L-1246-14-M
		1246-14-T	L-1246-14-T
Overall Dimensions	Width	19.5	
	Depth	27	
	Height	42	
Seat Height:		20	
Seat Depth:		19	
Inside Width:		19.5	
Wrap , Carton Weight, Cubes		22 , 22 , 12.79	
		Fabric	Leather
Grade D / Leather 1		\$957	\$1,617
Grade E / Leather 2		\$966	\$1,707
Grade F / Leather 3		\$975	\$1,797
Grade G / Leather 4		\$984	\$1,887
Grade H / Leather 5		\$975	\$1,977
Grade J / Leather 6		\$984	\$2,067
Grade K (COM)		\$993	
Grade L / Leather 8		\$1,002	\$2,862
Grade M (COL)		\$957	
Grade N		\$966	
Grade O		\$975	
Grade P		\$984	
Grade Q		\$975	
Grade R		\$984	
Grade S		\$993	
Grade T		\$1,002	
Grade U		\$993	
U+ Formula (See pg.12)		(# above U) x 9 + 993	
RISER		9	
COM (Yards)		2.75	
COL (sq. ft.)			57
Standard Seat Cushion:		High Resiliency 40	
Finish Options:		N	
Nail-head Trim:	Small	Std.	Std.
	Medium	N/A	N/A

CONRAD

Meet Conrad by Fairfield. He's a stylish, yet sophisticated upholstery lounge chair. Customizations are available to fit your needs in a resident room, a conference room, a common waiting room or in a meeting area. Whether you choose an arm with no options, add a cup holder, tablet, wireless charger, or any combination of the above, there are many choices to personalize your ideal Conrad.

1400+ Fairfield Fabrics and Leathers (plus COM)

2 style options

2 base options

4 LAF arm options

4 RAF arm options

step 1: select your style

Conrad lounge chair styles have a tight back and loose seat. Leather and nailhead trim are available at an upcharge. (Small or medium nails can be used along style base and small nails around outarms). Please view wood and nail finish options at fairfieldchair.com.



C-747C-XX Lounge Chair
Overall: w30.5 d30 h32
Wood Finish Options Available



C-747C-XX-C Lounge Chair
with Casters
Overall: w30.5 d30 h32
Standard with Nickel Casters

step 2: choose your LAF arm option Leave "X" in place for no LAF arm option. Example: C-747X-XX



(X) Plain Arm
C-747X-XX



(H) Cup Holder
C-747X-HX



(T) Tablet
C-747X-TX



(T) Tablet
down at side



(W) Wireless Charger
C-747X-WX

step 3: choose your RAF arm option Leave "X" in place for no RAF arm option. Example: C-747X-XX



(X) Plain Arm
C-747X-XX



(H) Cup Holder
C-747X-XH



(T) Tablet
C-747X-XT



(T) Tablet
down at side



(W) Wireless Charger
C-747X-XW

Style Build Example:

C - 7 4 7 C - T H - C
 Style Lounge Chair Tablet (LAF) Cup Holder (RAF) Casters Lounge Chairs Only



*No upcharge for casters. Casters are available at no additional cost on lounge chairs only. Chrome is standard for casters.

FAIRFIELD[®]
COMMERCIAL/HOSPITALITY

fairfieldchair.com

Style Number:		C-747C-XX	C-747C-XX-C
Leather Number:			
Name:		Conrad Lounge Chair	Conrad Lounge Chair with Casters
Overall Dimensions	Width	31.5	31.5
	Depth	31	31
	Height	32	32
Arm Height:		24	24
Seat Height:		19.25	19.25
Seat Depth:		19	19
Inside Width:		21	21
Standard Throw Pillow(s):		N/A	N/A
Wrap , Carton Weight, Cubes		55 , 68 , 18.08	55 , 68 , 18.08
FABRIC	D	\$2,325	\$2,325
	E	\$2,343	\$2,343
	F	\$2,361	\$2,361
	G	\$2,379	\$2,379
	H	\$2,397	\$2,397
	J	\$2,415	\$2,415
	K (COM)	\$2,433	\$2,433
	L	\$2,451	\$2,451
	M (COL)	\$2,469	\$2,469
	N	\$2,487	\$2,487
	O	\$2,505	\$2,505
	P	\$2,523	\$2,523
	Q	\$2,541	\$2,541
	R	\$2,559	\$2,559
	S	\$2,577	\$2,577
	T	\$2,595	\$2,595
	U	\$2,613	\$2,613
U+ Formula (See example on pg.12)		(# above U) x 18 + 2613	(# above U) x 18 + 2613
RISER		18	18
COM (Yards)		6.00	6.00
COL (sq. ft.)			
LEATHER	1	N/A	N/A
	2	N/A	N/A
	3	N/A	N/A
	4	N/A	N/A
	5	N/A	N/A
	6	N/A	N/A
	8	N/A	N/A
Standard Seat Cushion:		Endurance	Endurance
Finish Options:		Y	Y
Nail-head Trim:	Small	60	60
	Medium	75	75

URBANLIVING

Offering comprehensive choices and personalized seating designs that reflect your unique style. Urban Living styles are standard with Blendown throw pillows, back pillows and seat cushions. Nailhead trim is available as an optional upgrade. Throw pillows are not standard with vinyl application.

1300+ Fairfield Fabrics (plus COM)

2 seat options

4 arm options





2 back options

5 base options

48 frame options

step 1: select a seat option (S) = Standard Cushion or (B) = Bench Seat, available on sofas only | Then select additional frame options

step 2: select an arm option

<p>Border Track Arm XBXX-XX</p>  <p>8" wide</p>	<p>Optional nailhead trim is available.</p> <ul style="list-style-type: none"> • Small size nailhead trim is available in the place of welt. Trim is placed as a double border on front rail, arm panel, top of arm and top of back rail. • Medium nailhead trim is available on the welt of borders. Spaced 1" apart from the front rail, arm panel, top of arm and top of back rail.
<p>Chamfered Arm XHXX-XX</p>  <p>top 3.5" bottom 8"</p>	<p>Optional nailhead trim is available.</p> <ul style="list-style-type: none"> • Small size nailhead trim is available at the base. Placement is on the front rail, side rails and back rail. • Medium nailhead trim is available and spaced 1" apart and placed on the base of the front rail, side rails and back rail.
<p>Clipped Arm XCXX-XX</p>  <p>top 4" bottom 8"</p>	<p>Optional nailhead trim is available.</p> <ul style="list-style-type: none"> • Small size nailhead trim is available. Placement is head to head on the base of the front rail, side rails and back rail. • Medium nailhead trim is available and spaced 1" apart and placed on the base of the front rail, side rails and back rail.
<p>Small Track Arm XSXX-XX</p>  <p>2.75" wide</p>	<p>Optional nailhead trim is available.</p> <ul style="list-style-type: none"> • Small size nailhead trim is available on the inside arm over welt (rectangular shape), on the outside arm over welt (rectangular shape) and on the outside back over welt (rectangular shape). • Medium nailhead trim is not available

step 3: select a back option Standard with English Seam



XXBX-XX
Border Back



XXMX-XX
20" Multi-Pillow Back

step 4: select a base option



XXXA-XX
Acrylic Leg
w4 d 4h 3.5 in.



XXXM-XX
Metal Leg
nickel finish | w4 d4 h3.5 in.



XXXM-XX
Metal Leg
bronze finish | w4 d4 h3.5 in.



XXXP-XX
Plinth Base
brown finish | w5 d5 h1 in.



XXXW-XX
Wood Leg
w5 d5 h3.5 in.



Style Build Example:

S C M W - 50
Standard Cushion Clipped Arm Multi-Pillow Back Wood Leg Sofa

step 5: select your individual styles

Border Track Arm (B) & Chamfered Arm (H)

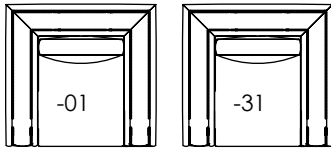

XXXX-01 Lounge Chair
w38 d38.5 h32.5 in.
ah26 sh19.5 sd21.5 iw22 in.

XXXX-31 Swivel Chair
w38 d38.5 h32.5 in.
ah26 sh19.5 sd21.5 iw22 in.
Available with Plinth Base Only

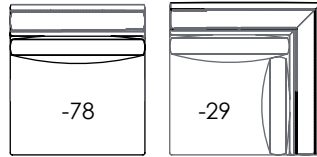

XXXX-78 Armless Chair
w34 d38.5 h32.5 in.
ah26 sh19.5 sd21.5 iw34 in.

XXXX-29 Corner Chair
w38.5 d38.5 h32.5 in.
ah26 sh19.5 sd21.5 iw21.5 in.

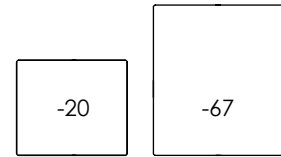

XXXX-20 Ottoman
w28 d24 h16.5 in.

XXXX-67 Bumper Ottoman
w34 d38.5 h19.5 in.

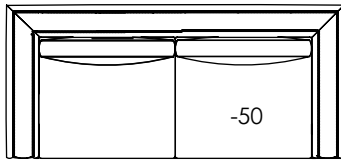

XXXX-50 Sofa
w85 d38.5 h32.5 in.
ah26 sh19.5 sd21.5 iw68 in.
Standard with (2) 18" throw pillows

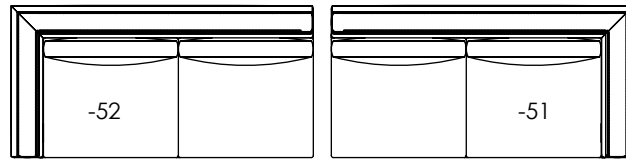

XXXX-52 LAF Sofa | XXXX-51 RAF Sofa
w76 d38.5 h32.5 in.
ah26 sh19.5 sd21.5 iw68 in.
Standard with (1) 18" throw pillow

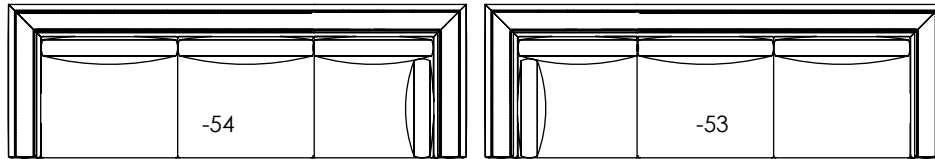

XXXX-54 LAF Corner Sofa | XXXX-53 RAF Corner Sofa
w115 d38.5 h32.5 in.
ah26 sh19.5 sd21.5 iw89.5 in.
Standard with (2) 18" throw pillows

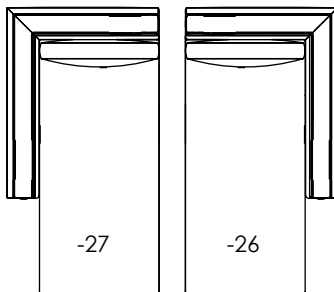

XXXX-27 LAF Chaise | XXXX-26 RAF Chaise
w38.5 d72 h32.5 in.
ah26 sh19.5 sd53 iw30 in.
Standard with (1) 18" throw pillow

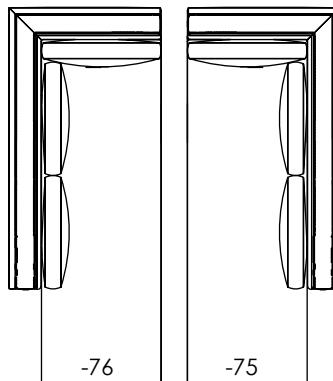

XXXX-75 RAF Cuddle Chaise
w38.5 d95.5 h32.5 in.
ah26 sh19.5 sd78 iw21.5 in.

XXXX-76 LAF Cuddle Chaise
w38.5 d95.5 h32.5 in.
ah26 sh19.5 sd78 iw21.5 in.
Standard with (1) 18" throw pillow

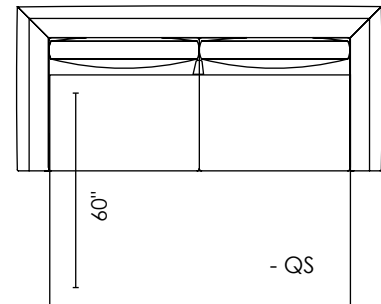

XXXX-QS Queen Sleeper Sofa
w94.75 d39.75 h32 in.
ah25.5 sh17.5 sd23 iw79 in.
Standard with (2) 18" Blendown
throw pillows

The Urban Living Queen Sleeper
is available with each arm style, with
a bench seat, border back pillow and
with the Plinth leg option only

line drawings shown at 1/4 inch scale

Clipped Arm (C)

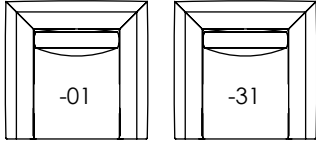

XXXX-01 Lounge Chair
w36 d37.5 h32.5 in.
ah26 sh19.5 sd21.5 iw22 in.

XXXX-31 Swivel Chair
w36 d37.5 h32.5 in.
ah26 sh19.5 sd21.5 iw22 in.
Available with Plinth Base Only



XXXX-78 Armless Chair
w34 d37.5 h32.5 in.
ah26 sh19.5 sd21.5 iw34 in.

XXXX-29 Corner Chair
w34 d37.5 h32.5 in.
ah26 sh19.5 sd21.5 iw21.5 in.

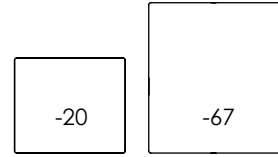

XXXX-20 Ottoman
w28 d24 h16 in.

XXXX-67 Bumper Ottoman
w34 d37.5 h19.5 in.

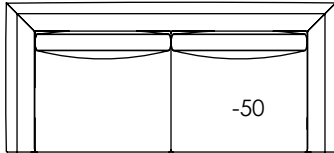

XXXX-50 Sofa
w83 d37.5 h32.5 in.
ah26 sh19.5 sd21.5 iw68 in.
Standard with (2) 18" throw pillows

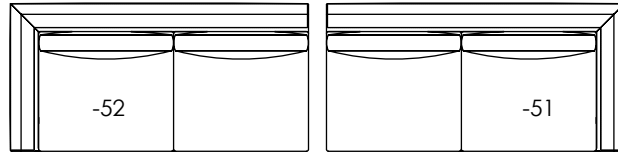

XXXX-52 LAF Sofa | XXXX-51 RAF Sofa
w75 d37.5 h32.5 in.
ah26 sh19.5 sd21.5 iw68 in.
Standard with (1) 18" throw pillow

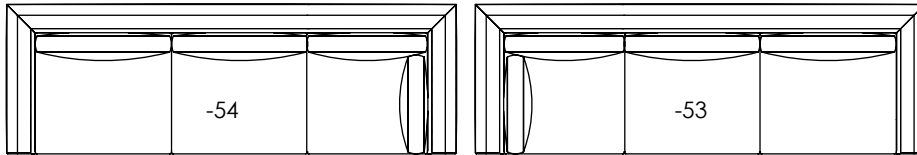

XXXX-54 LAF Corner Sofa | XXXX-53 RAF Corner Sofa
w113 d37.5 h32.5 in.
ah26 sh19.5 sd21.5 iw89.5 in.
Standard with (2) 18" throw pillows

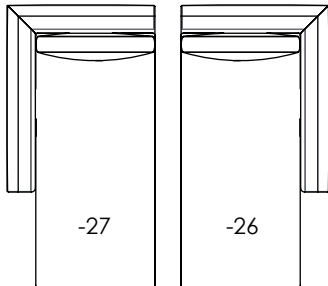

XXXX-27 LAF Chaise | XXXX-26 RAF Chaise
w37.5 d71 h32.5 in.
ah26 sh19.5 sd53 iw30 in.
Standard with (1) 18" throw pillow

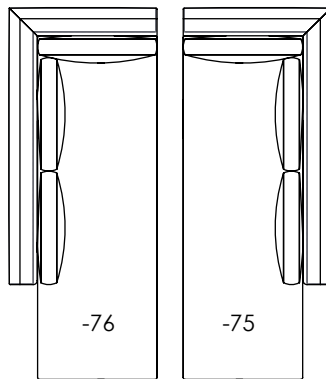

XXXX-76 LAF Cuddle Chaise
w37.5 d94.5 h32.5 in.
ah26 sh19.5 sd78 iw21.5 in.

XXXX-75 RAF Cuddle Chaise
w37.5 d94.5 h32.5 in.
ah26 sh19.5 sd78 iw21.5 in.
Standard with (1) 18" throw pillow

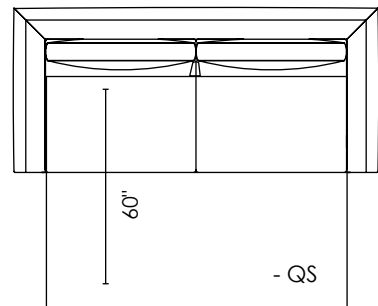

XXXX-QS Queen Sleeper Sofa
w92.75 d38 h32 in.
ah25.5 sh17.5 sd23 iw79 in.
Standard with (2) 18" Blendown
throw pillows

The Urban Living Queen Sleeper
is available with each arm style, with
a bench seat, border back pillow and
with the Plinth leg option only

line drawings shown at 1/4 inch scale

Small Track Arm (S)

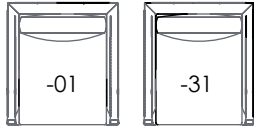

XXXX-01 Lounge Chair
w28 d33 h32.5 in.
ah26 sh19.5 sd21.5 iw22 in.

XXXX-31 Swivel Chair
w28 d32.5 h32.5 in.
ah26 sh19.5 sd21.5 iw22 in.
Available with Plinth Base Only

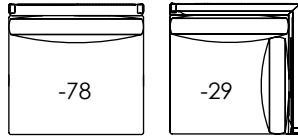

XXXX-78 Armless Chair
w34 d33 h32.5 in.
ah26 sh19.5 sd21.5 iw34 in.

XXXX-29 Corner Chair
w33 d33 h32.5 in.
ah26 sh19.5 sd21.5 iw21.5 in.

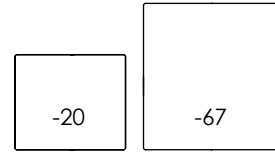

XXXX-20 Ottoman
w28 d24 h16 in.

XXXX-67 Bumper Ottoman
w34 d33 h19.5 in.

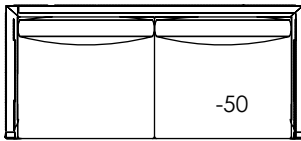

XXXX-50 Sofa
w75 d33 h32.5 in.
ah26 sh19.5 sd21.5 iw68 in.
Standard with (2) 18" throw pillows

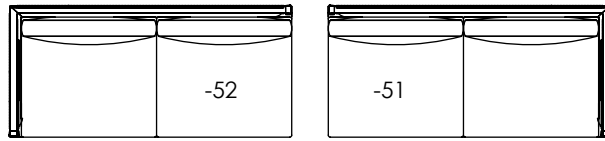

XXXX-52 LAF Sofa | XXXX-51 RAF Sofa
w71 d33 h32.5 in.
ah26 sh19.5 sd21.5 iw68 in.
Standard with (1) 18" throw pillow

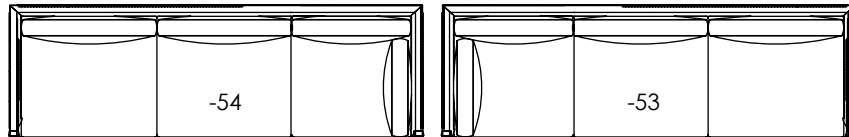

XXXX-54 LAF Corner Sofa | XXXX-53 RAF Corner Sofa
w104 d33 h32.5 in.
ah26 sh19.5 sd21.5 iw89.5 in.
Standard with (2) 18" throw pillows

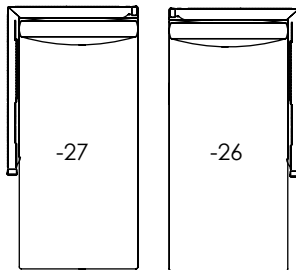

XXXX-27 LAF Chaise
w33 d67 h32.5 in.
ah26 sh19.5 sd53 iw30 in.

XXXX-26 RAF Chaise
w33 d67 h32.5 in.
ah26 sh19.5 sd53 iw30 in.
Standard with (1) 18" throw pillow

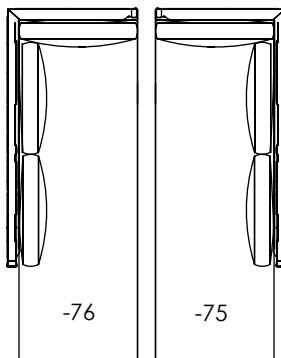

XXXX-76 LAF Cuddle Chaise
w33 d90 h32.5 in.
ah26 sh19.5 sd78 iw21.5 in.

XXXX-75 RAF Cuddle Chaise
w33 d90 h32.5 in.
ah26 sh19.5 sd78 iw21.5 in.
Standard with (1) 18" throw pillow

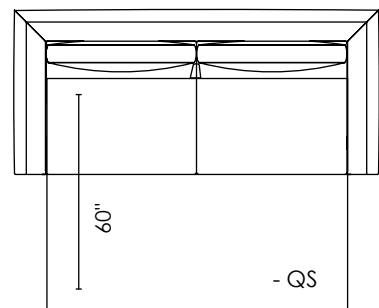

XXXX-QS Queen Sleeper Sofa
w84 d36.5 h32 in.
ah25.5 sh17.5 sd23 iw79 in.
Standard with (2) 18" Blendown
throw pillows

The Urban Living Queen Sleeper
is available with each arm style, with
a bench seat, border back pillow and
with the Plinth leg option only

line drawings shown at 1/4 inch scale

FAIRFIELD®

fairfieldchair.com   

Style Number:		Urban Living C-(XXXX)-01			Urban Living C-(XXXX)-20		
Leather Number:							
Name:		Lounge Chair			Ottoman		
		BORDER TRACK ARM ----- CHAMFERED ARM	SMALL TRACK ARM	CLIPPED ARM	BORDER TRACK ARM ----- CHAMFERED ARM	SMALL TRACK ARM	CLIPPED ARM
Overall Dimensions:	Width	38	28	36	28	28	28
	Depth	38.5	33	37.5	24	24	24
	Height		32.5			16	
Arm Height:		26			N/A		
Seat Height:		19.5			N/A		
Seat Depth:		21.5			N/A		
Inside Width:		22			N/A		
Standard Throw Pillow(s):		N/A			N/A		
Wrap, Carton Weight, Cubes		80, 90, 27.51			40, 45, 6.22		
FABRIC	D	\$2,640			\$1,239		
	E	\$2,661			\$1,248		
	F	\$2,682			\$1,257		
	G	\$2,703			\$1,266		
	H	\$2,724			\$1,275		
	J	\$2,745			\$1,284		
	K (COM)	\$2,766			\$1,293		
	L	\$2,787			\$1,302		
	M (COL)	\$2,808			\$1,311		
	N	\$2,829			\$1,320		
	O	\$2,850			\$1,329		
	P	\$2,871			\$1,338		
	Q	\$2,892			\$1,347		
	R	\$2,913			\$1,356		
	S	\$2,934			\$1,365		
	T	\$2,955			\$1,374		
	U	\$2,976			\$1,383		
U+ Formula (See example on pg. 12)	(# above U) x 21 + 2976			(# above U) x 9 + 1383			
RISER		21			9		
COM (Yards)		6.50			2.75		
COL (sq. ft.)							
LEATHER	1	N/A			N/A		
	2	N/A			N/A		
	3	N/A			N/A		
	4	N/A			N/A		
	5	N/A			N/A		
	6	N/A			N/A		
	7	N/A			N/A		
	8	N/A			N/A		
Standard Seat Cushion:		Endurance			High Resiliency 40		
Finish Options:		N			N		
Nail-head Trim:	Small	45	135	45	45	45	45
	Medium	60	N/A	60	60	N/A	60

		Urban Living			Urban Living		
Style Number:		C-(XXXX)-26			C-(XXXX)-27		
Leather Number:							
Name:		Right Arm Facing Chaise			Left Arm Facing Chaise		
		BORDER TRACK ARM ----- CHAMFERED ARM	SMALL TRACK ARM	CLIPPED ARM	BORDER TRACK ARM ----- CHAMFERED ARM	SMALL TRACK ARM	CLIPPED ARM
Overall Dimensions:	Width	38.5	33	37.5	38.5	33	37.5
	Depth	72	67	71	72	67	71
	Height	32.5			32.5		
Arm Height:		26			26		
Seat Height:		19.5			19.5		
Seat Depth:		53			53		
Inside Width:		30			30		
Standard Throw Pillow(s):		N/A			N/A		
Wrap, Carton Weight, Cubes		120, 149, 70.78			115, 149, 70.78		
FABRIC	D	\$3,960			\$3,960		
	E	\$4,005			\$4,005		
	F	\$4,050			\$4,050		
	G	\$4,095			\$4,095		
	H	\$4,140			\$4,140		
	J	\$4,185			\$4,185		
	K (COM)	\$4,230			\$4,230		
	L	\$4,275			\$4,275		
	M (COL)	\$4,320			\$4,320		
	N	\$4,365			\$4,365		
	O	\$4,410			\$4,410		
	P	\$4,455			\$4,455		
	Q	\$4,500			\$4,500		
	R	\$4,545			\$4,545		
	S	\$4,590			\$4,590		
	T	\$4,635			\$4,635		
	U	\$4,680			\$4,680		
U+ Formula (See example on pg. 12)	(# above U) x 45 + 4680			(# above U) x 45 + 4680			
RISER		45			45		
COM (Yards)		13.50			13.50		
COL (sq. ft.)							
LEATHER	1	N/A			N/A		
	2	N/A			N/A		
	3	N/A			N/A		
	4	N/A			N/A		
	5	N/A			N/A		
	6	N/A			N/A		
	8	N/A			N/A		
Standard Seat Cushion:		Endurance			Endurance		
Finish Options:		N			N		
Nail-head Trim:	Small	75	75	75	75	75	75
	Medium	90	N/A	90	90	N/A	90

Style Number:		Urban Living C-(XXXX)-29			Urban Living C-(XXXX)-31		
Leather Number:							
Name:		Corner Chair			Swivel Chair		
		BORDER TRACK ARM ----- CHAMFERED ARM	SMALL TRACK ARM	CLIPPED ARM	BORDER TRACK ARM ----- CHAMFERED ARM	SMALL TRACK ARM	CLIPPED ARM
Overall Dimensions:	Width	38.5	33	34	38	28	36
	Depth	38.5	33	37.5	38.5	32.5	37.5
	Height		32.5			32.5	
Arm Height:		26			26		
Seat Height:		19.5			19.5		
Seat Depth:		21.5			21.5		
Inside Width:		21.5			22		
Standard Throw Pillow(s):		N/A			N/A		
Wrap, Carton Weight, Cubes		80, 100, 42.09			75, 92, 36.49		
FABRIC	D	\$2,805			\$2,640		
	E	\$2,835			\$2,661		
	F	\$2,865			\$2,682		
	G	\$2,895			\$2,703		
	H	\$2,925			\$2,724		
	J	\$2,955			\$2,745		
	K (COM)	\$2,985			\$2,766		
	L	\$3,015			\$2,787		
	M (COL)	\$3,045			\$2,808		
	N	\$3,075			\$2,829		
	O	\$3,105			\$2,850		
	P	\$3,135			\$2,871		
	Q	\$3,165			\$2,892		
	R	\$3,195			\$2,913		
	S	\$3,225			\$2,934		
	T	\$3,255			\$2,955		
	U	\$3,285			\$2,976		
U+ Formula (See example on pg. 12)	(# above U) x 30 + 3285			(# above U) x 21 + 2976			
RISER		30			21		
COM (Yards)		8.25			6.50		
COL (sq. ft.)							
LEATHER	1	N/A			N/A		
	2	N/A			N/A		
	3	N/A			N/A		
	4	N/A			N/A		
	5	N/A			N/A		
	6	N/A			N/A		
	8	N/A			N/A		
Standard Seat Cushion:		Endurance			Endurance		
Finish Options:		N			N		
Nail-head Trim:	Small	60	105	60	45	135	45
	Medium	75	N/A	75	60	N/A	60

		Urban Living			Urban Living		
Style Number:		C-(XXXX)-50			C-(XXXX)-51		
Leather Number:							
Name:		Sofa			Right Arm Facing Sofa		
		BORDER TRACK ARM ----- CHAMFERED ARM	SMALL TRACK ARM	CLIPPED ARM	BORDER TRACK ARM ----- CHAMFERED ARM	SMALL TRACK ARM	CLIPPED ARM
Overall Dimensions:	Width	85	75	83	76	71	75
	Depth	38.5	33	37.5	38.5	33	37.5
	Height		32.5			32.5	
Arm Height:		26			26		
Seat Height:		19.5			19.5		
Seat Depth:		21.5			21.5		
Inside Width:		68			68		
Standard Throw Pillow(s):		N/A			N/A		
Wrap , Carton Weight,Cubes		225 , 263 , 79.34			109 , 144 , 73.53		
FABRIC	D	\$4,539			\$4,209		
	E	\$4,599			\$4,254		
	F	\$4,659			\$4,299		
	G	\$4,719			\$4,344		
	H	\$4,779			\$4,389		
	J	\$4,839			\$4,434		
	K (COM)	\$4,899			\$4,479		
	L	\$4,959			\$4,524		
	M (COL)	\$5,019			\$4,569		
	N	\$5,079			\$4,614		
	O	\$5,139			\$4,659		
	P	\$5,199			\$4,704		
	Q	\$5,259			\$4,749		
	R	\$5,319			\$4,794		
	S	\$5,379			\$4,839		
	T	\$5,439			\$4,884		
	U	\$5,499			\$4,929		
U+ Formula (See example on pg.12)	(# above U) x 60 + 5499			(# above U) x 45 + 4929			
RISER		60			45		
COM (Yards)		18.75			16.00		
COL (sq. ft.)							
LEATHER	1	N/A			N/A		
	2	N/A			N/A		
	3	N/A			N/A		
	4	N/A			N/A		
	5	N/A			N/A		
	6	N/A			N/A		
	8	N/A			N/A		
Standard Seat Cushion:		Endurance			Endurance		
Finish Options:		N			N		
Nail-head Trim:	Small	75	150	75	75	105	75
	Medium	90	N/A	90	90	N/A	90

		Urban Living			Urban Living		
Style Number:		C-(XXXX)-52			C-(XXXX)-53		
Leather Number:							
Name:		Left Arm Facing Sofa			Right Arm Facing Corner Sofa		
		BORDER TRACK ARM ----- CHAMFERED ARM	SMALL TRACK ARM	CLIPPED ARM	BORDER TRACK ARM ----- CHAMFERED ARM	SMALL TRACK ARM	CLIPPED ARM
Overall Dimensions:	Width	76	71	75	115	104	113
	Depth	38.5	33	37.5	38.5	33	37.5
	Height		32.5			32.5	
Arm Height:		26			26		
Seat Height:		19.5			19.5		
Seat Depth:		21.5			21.5		
Inside Width:		68			89.5		
Standard Throw Pillow(s):		N/A			N/A		
Wrap , Carton Weight,Cubes		100 , 142 , 82.92			210 , 265 , 83.27		
FABRIC	D	\$4,209			\$5,529		
	E	\$4,254			\$5,592		
	F	\$4,299			\$5,655		
	G	\$4,344			\$5,718		
	H	\$4,389			\$5,781		
	J	\$4,434			\$5,844		
	K (COM)	\$4,479			\$5,907		
	L	\$4,524			\$5,970		
	M (COL)	\$4,569			\$6,033		
	N	\$4,614			\$6,096		
	O	\$4,659			\$6,159		
	P	\$4,704			\$6,222		
	Q	\$4,749			\$6,285		
	R	\$4,794			\$6,348		
	S	\$4,839			\$6,411		
	T	\$4,884			\$6,474		
	U	\$4,929			\$6,537		
U+ Formula (See example on pg.12)	(# above U) x 45 + 4929			(# above U) x 63 + 6537			
RISER		45			63		
COM (Yards)		16.00			22.50		
COL (sq. ft.)							
LEATHER	1	N/A			N/A		
	2	N/A			N/A		
	3	N/A			N/A		
	4	N/A			N/A		
	5	N/A			N/A		
	6	N/A			N/A		
	8	N/A			N/A		
Standard Seat Cushion:		Endurance			Endurance		
Finish Options:		N			N		
Nail-head Trim:	Small	75	105	75	210	150	90
	Medium	90	N/A	90	225	N/A	105

		Urban Living			Urban Living		
Style Number:		C-(XXXX)-54			C-(XXXX)-67		
Leather Number:							
Name:		Left Arm Facing Corner Sofa			Bumper Ottoman		
		BORDER TRACK ARM ----- CHAMFERED ARM	SMALL TRACK ARM	CLIPPED ARM	BORDER TRACK ARM ----- CHAMFERED ARM	SMALL TRACK ARM	CLIPPED ARM
Overall Dimensions:	Width	115	104	113	34		
	Depth	38.5	33	37.5	38.5	33	37.5
	Height	32.5			19.5		
Arm Height:		26			N/A		
Seat Height:		19.5			N/A		
Seat Depth:		21.5			N/A		
Inside Width:		89.5			N/A		
Standard Throw Pillow(s):		N/A			N/A		
Wrap, Carton Weight, Cubes		210, 265, 83.27			55, 70, 14.77		
FABRIC	D	\$5,529			\$2,031		
	E	\$5,592			\$2,052		
	F	\$5,655			\$2,073		
	G	\$5,718			\$2,094		
	H	\$5,781			\$2,115		
	J	\$5,844			\$2,136		
	K (COM)	\$5,907			\$2,157		
	L	\$5,970			\$2,178		
	M (COL)	\$6,033			\$2,199		
	N	\$6,096			\$2,220		
	O	\$6,159			\$2,241		
	P	\$6,222			\$2,262		
	Q	\$6,285			\$2,283		
	R	\$6,348			\$2,304		
	S	\$6,411			\$2,325		
	T	\$6,474			\$2,346		
	U	\$6,537			\$2,367		
U+ Formula (See example on pg. 12)	(# above U) x 63 + 6537			(# above U) x 21 + 2367			
RISER		63			21		
COM (Yards)		22.50			6.75		
COL (sq. ft.)							
LEATHER	1	N/A			N/A		
	2	N/A			N/A		
	3	N/A			N/A		
	4	N/A			N/A		
	5	N/A			N/A		
	6	N/A			N/A		
	8	N/A			N/A		
Standard Seat Cushion:		Endurance			Endurance		
Finish Options:		N			N		
Nail-head Trim:	Small	210	150	90	60	60	60
	Medium	225	N/A	105	75	N/A	75

Style Number:		Urban Living C-(XXXX)-75			Urban Living C-(XXXX)-76		
Leather Number:							
Name:		Right Arm Facing Cuddle Chaise			Left Arm Facing Cuddle Chaise		
		BORDER TRACK ARM ----- CHAMFERED ARM	SMALL TRACK ARM	CLIPPED ARM	BORDER TRACK ARM ----- CHAMFERED ARM	SMALL TRACK ARM	CLIPPED ARM
Overall Dimensions:	Width	38.5	33	37.5	38.5	33	37.5
	Depth	95.5	90	94.5	95.5	90	94.5
	Height		32.5			32.5	
Arm Height:		26			26		
Seat Height:		19.5			19.5		
Seat Depth:		78			78		
Inside Width:		21.5			21.5		
Standard Throw Pillow(s):		N/A			N/A		
Wrap , Carton Weight,Cubes		150 , 194 , 82.92			150 , 194 , 82.92		
FABRIC	D	\$4,605			\$4,605		
	E	\$4,659			\$4,659		
	F	\$4,713			\$4,713		
	G	\$4,767			\$4,767		
	H	\$4,821			\$4,821		
	J	\$4,875			\$4,875		
	K (COM)	\$4,929			\$4,929		
	L	\$4,983			\$4,983		
	M (COL)	\$5,037			\$5,037		
	N	\$5,091			\$5,091		
	O	\$5,145			\$5,145		
	P	\$5,199			\$5,199		
	Q	\$5,253			\$5,253		
	R	\$5,307			\$5,307		
	S	\$5,361			\$5,361		
	T	\$5,415			\$5,415		
	U	\$5,469			\$5,469		
U+ Formula (See example on pg.12)	(# above U) x 54 + 5469			(# above U) x 54 + 5469			
RISER		54			54		
COM (Yards)		18.00			18.00		
COL (sq. ft.)							
LEATHER	1	N/A			N/A		
	2	N/A			N/A		
	3	N/A			N/A		
	4	N/A			N/A		
	5	N/A			N/A		
	6	N/A			N/A		
	8	N/A			N/A		
Standard Seat Cushion:		Endurance			Endurance		
Finish Options:		N			N		
Nail-head Trim:	Small	210	150	90	210	150	90
	Medium	225	N/A	105	225	N/A	105

Style Number:		Urban Living C-(XXXX)-78			Urban Living C-(XXXX)-QS		
Leather Number:							
Name:		Armless Chair			Queen Sleeper		
		BORDER TRACK ARM ----- CHAMFERED ARM	SMALL TRACK ARM	CLIPPED ARM	BORDER TRACK ARM ----- CHAMFERED ARM	SMALL TRACK ARM	CLIPPED ARM
Overall Dimensions:	Width	34	34	34	94.75	84	92.75
	Depth	38.5	33	37.5	39.75	36.5	38
	Height		32.5			32	
Arm Height:		26			25.5		
Seat Height:		19.5			17.5		
Seat Depth:		21.5			23		
Inside Width:		34			79		
Standard Throw Pillow(s):		N/A			N/A		
Wrap , Carton Weight,Cubes		65 , 82 , 36.49			253 , 297 , 82.92		
FABRIC	D	\$2,559			\$6,105		
	E	\$2,589			\$6,150		
	F	\$2,619			\$6,195		
	G	\$2,649			\$6,240		
	H	\$2,679			\$6,285		
	J	\$2,709			\$6,330		
	K (COM)	\$2,739			\$6,375		
	L	\$2,769			\$6,420		
	M (COL)	\$2,799			\$6,465		
	N	\$2,829			\$6,510		
	O	\$2,859			\$6,555		
	P	\$2,889			\$6,600		
	Q	\$2,919			\$6,645		
	R	\$2,949			\$6,690		
	S	\$2,979			\$6,735		
	T	\$3,009			\$6,780		
	U	\$3,039			\$6,825		
U+ Formula (See example on pg.12)	(# above U) x 30 + 3039			(# above U) x 45 + 6825			
RISER		30			45		
COM (Yards)		8.25			17.75		
COL (sq. ft.)							
LEATHER	1	N/A			N/A		
	2	N/A			N/A		
	3	N/A			N/A		
	4	N/A			N/A		
	5	N/A			N/A		
	6	N/A			N/A		
	8	N/A			N/A		
Standard Seat Cushion:		Endurance			Support Plus		
Finish Options:		N			N		
Nail-head Trim:	Small	60	45	60	210	210	210
	Medium	75	N/A	75	N/A	N/A	N/A

THROW PILLOWS

FB46-00

Channelled Bolster

Width: 46 Depth: 7 Height: 15

Weight: 5 / 5 lbs Cube: 2.79

Standard Filling: Blown Fiber Filling COM: 3.75 yards

D	E	F	G	H	J	K ^{COM}	L	M	N	O	P	Q	R	S	T	U	(# above U) *	S Nail	M Nail
420	420	420	420	420	435	435	435	435	435	465	465	465	465	465	510	510	12 (Riser) + 510 (U)	N/A	N/A

FB60-00

Channelled Bolster

Width: 60 Depth: 7 Height: 15

Weight: 8 / 8 lbs Cube: 3.64

Standard Filling: Blown Fiber Filling COM: 4.75 yards

D	E	F	G	H	J	K ^{COM}	L	M	N	O	P	Q	R	S	T	U	(# above U) *	S Nail	M Nail
495	495	495	495	495	525	525	525	525	525	585	585	585	585	585	630	630	15 (Riser) + 630 (U)	N/A	N/A

FF46-00

Bolster

Width: 46 Depth: 2 Height: 14

Weight: 5 / 5 lbs Cube: 0.74

Standard Filling: Blown Fiber Filling COM: 1.5 yards

D	E	F	G	H	J	K ^{COM}	L	M	N	O	P	Q	R	S	T	U	(# above U) *	S Nail	M Nail
315	315	315	315	315	330	330	330	330	330	345	345	345	345	345	375	375	9 (Riser) + 375 (U)	N/A	N/A

FF60-00

Bolster

Width: 60 Depth: 2 Height: 14

Weight: 8 / 8 lbs Cube: 0.97

Standard Filling: Blown Fiber Filling COM: 2 yards

D	E	F	G	H	J	K ^{COM}	L	M	N	O	P	Q	R	S	T	U	(# above U) *	S Nail	M Nail
360	360	360	360	360	375	375	375	375	375	390	390	390	390	390	420	420	9 (Riser) + 420 (U)	N/A	N/A

OR12-BD

Sphere Pillow

with Blendown Filling

Width: 12 Depth: 12 Height: 12

Weight: 2 / 2 lbs Cube: 1

Standard Filling: Blendown COM: 1.25 yards

D	E	F	G	H	J	K ^{COM}	L	M	N	O	P	Q	R	S	T	U	(# above U) *	S Nail	M Nail
225	225	225	225	225	240	240	240	240	240	255	255	255	255	255	270	270	3 (Riser) + 270 (U)	N/A	N/A

OR12-00

Sphere Pillow

with Fiber Filling

Width: 12 Depth: 12 Height: 12

Weight: 2 / 2 lbs Cube: 1

Standard Filling: Blown Fiber Filling COM: 1.25 yards

D	E	F	G	H	J	K ^{COM}	L	M	N	O	P	Q	R	S	T	U	(# above U) *	S Nail	M Nail
195	195	195	195	195	210	210	210	210	210	225	225	225	225	225	240	240	3 (Riser) + 240 (U)	N/A	N/A

0012-BD

Round Welted Border Pillow

Blendown Filling

Width: 14.5 Depth: 6 Height: 0

Weight: 2 / 2 lbs Cube: 0

Standard Filling: Blendown COM: 1.5 yards

D	E	F	G	H	J	K ^{COM}	L	M	N	O	P	Q	R	S	T	U	(# above U) *	S Nail	M Nail
210	210	210	210	210	225	225	225	225	225	240	240	240	240	240	255	255	6 (Riser) + 255 (U)	N/A	N/A

THROW PILLOWS

0012-00

Round Welted Border Pillow

Blown Fiber Filling

Width: 14.5 Depth: 6 Height: 0

Weight: 2 / 0 lbs Cube: 0

Standard Filling: Blown Fiber Filling COM: 1.5 yards

D	E	F	G	H	J	K ^{COM}	L	M	N	O	P	Q	R	S	T	U	(# above U) *	S Nail	M Nail
195	195	195	195	195	210	210	210	210	210	225	225	225	225	225	255	255	6 (Riser) + 255 (U)	N/A	N/A

0013-BD

Round Welted Border Pillow with buttons

Blendown Filling

Width: 14.5 Depth: 6 Height: 0

Weight: 2 / 2 lbs Cube: 0

Standard Filling: Blendown COM: 1.5 yards

D	E	F	G	H	J	K ^{COM}	L	M	N	O	P	Q	R	S	T	U	(# above U) *	S Nail	M Nail
225	225	225	225	225	240	240	240	240	240	255	255	255	255	255	270	270	6 (Riser) + 270 (U)	N/A	N/A

0013-00

Round Welted Border Pillow with buttons

Blown Fiber Filling

Width: 14.5 Depth: 6 Height: 0

Weight: 2 / 2 lbs Cube: 0

Standard Filling: Blown Fiber Filling COM: 1.5 yards

D	E	F	G	H	J	K ^{COM}	L	M	N	O	P	Q	R	S	T	U	(# above U) *	S Nail	M Nail
195	195	195	195	195	210	210	210	210	210	225	225	225	225	225	240	240	6 (Riser) + 240 (U)	N/A	N/A

0014-BD

Welted Square Pillow

Width: 14 Depth: 4 Height: 14

Weight: 5 / 5 lbs Cube: 0.45

Standard Filling: Blendown COM: 1 yards

D	E	F	G	H	J	K ^{COM}	L	M	N	O	P	Q	R	S	T	U	(# above U) *	S Nail	M Nail
180	180	180	180	180	195	195	195	195	195	210	210	210	210	210	240	240	3 (Riser) + 240 (U)	N/A	N/A

0014-00

Welted Square Pillow

Width: 14 Depth: 4 Height: 14

Weight: 5 / 5 lbs Cube: 0.45

Standard Filling: Blown Fiber Filling COM: 1 yards

D	E	F	G	H	J	K ^{COM}	L	M	N	O	P	Q	R	S	T	U	(# above U) *	S Nail	M Nail
150	150	150	150	150	165	165	165	165	165	180	180	180	180	180	210	210	3 (Riser) + 210 (U)	N/A	N/A

0016-BD

Welted Square Pillow

Width: 16 Depth: 5 Height: 16

Weight: 5 / 5 lbs Cube: 0.74

Standard Filling: Blendown COM: 1.25 yards

D	E	F	G	H	J	K ^{COM}	L	M	N	O	P	Q	R	S	T	U	(# above U) *	S Nail	M Nail
180	180	180	180	180	195	195	195	195	195	210	210	210	210	210	240	240	6 (Riser) + 240 (U)	N/A	N/A

0016-00

Welted Square Pillow

Width: 16 Depth: 5 Height: 16

Weight: 5 / 5 lbs Cube: 0.74

Standard Filling: Blown Fiber Filling COM: 1.25 yards

D	E	F	G	H	J	K ^{COM}	L	M	N	O	P	Q	R	S	T	U	(# above U) *	S Nail	M Nail
150	150	150	150	150	165	165	165	165	165	180	180	180	180	180	210	210	6 (Riser) + 210 (U)	N/A	N/A

THROW PILLOWS

0018-BD

Welted Square Pillow

Width: 18 Depth: 6 Height: 18

Weight: 2 / 2 lbs Cube: 1.12

Standard Filling: Blendown COM: 1.25 yards

D	E	F	G	H	J	K ^{COM}	L	M	N	O	P	Q	R	S	T	U	(# above U) *	S Nail	M Nail
195	195	195	195	195	210	210	210	210	210	225	225	225	225	225	255	255	6 (Riser) + 255 (U)	N/A	N/A

0018-00

Welted Square Pillow

Width: 18 Depth: 6 Height: 18

Weight: 2 / 2 lbs Cube: 1.12

Standard Filling: Blown Fiber Filling COM: 1.25 yards

D	E	F	G	H	J	K ^{COM}	L	M	N	O	P	Q	R	S	T	U	(# above U) *	S Nail	M Nail
165	165	165	165	165	180	180	180	180	180	195	195	195	195	195	225	225	6 (Riser) + 225 (U)	N/A	N/A

0020-BD

Welted Square Pillow

Width: 20 Depth: 6 Height: 20

Weight: 5 / 5 lbs Cube: 1.38

Standard Filling: Blendown COM: 1.25 yards

D	E	F	G	H	J	K ^{COM}	L	M	N	O	P	Q	R	S	T	U	(# above U) *	S Nail	M Nail
210	210	210	210	210	225	225	225	225	225	240	240	240	240	240	270	270	6 (Riser) + 270 (U)	N/A	N/A

0020-00

Welted Square Pillow

Width: 20 Depth: 6 Height: 20

Weight: 5 / 5 lbs Cube: 1.38

Standard Filling: Blown Fiber Filling COM: 1.25 yards

D	E	F	G	H	J	K ^{COM}	L	M	N	O	P	Q	R	S	T	U	(# above U) *	S Nail	M Nail
180	180	180	180	180	195	195	195	195	195	210	210	210	210	210	240	240	6 (Riser) + 240 (U)	N/A	N/A

0022-BD

Welted Square Pillow

Width: 22 Depth: 6 Height: 22

Weight: 5 / 5 lbs Cube: 1.68

Standard Filling: Blendown COM: 1.5 yards

D	E	F	G	H	J	K ^{COM}	L	M	N	O	P	Q	R	S	T	U	(# above U) *	S Nail	M Nail
225	225	225	225	225	240	240	240	240	240	255	255	255	255	255	300	300	6 (Riser) + 300 (U)	N/A	N/A

0022-00

Welted Square Pillow

Width: 22 Depth: 6 Height: 22

Weight: 5 / 5 lbs Cube: 1.68

Standard Filling: Blown Fiber Filling COM: 1.5 yards

D	E	F	G	H	J	K ^{COM}	L	M	N	O	P	Q	R	S	T	U	(# above U) *	S Nail	M Nail
195	195	195	195	195	210	210	210	210	210	225	225	225	225	225	270	270	6 (Riser) + 270 (U)	N/A	N/A

0024-BD

Welted Square Pillow

Width: 24 Depth: 0 Height: 24

Weight: 5 / 5 lbs Cube: 0

Standard Filling: Blendown COM: 1.5 yards

D	E	F	G	H	J	K ^{COM}	L	M	N	O	P	Q	R	S	T	U	(# above U) *	S Nail	M Nail
240	240	240	240	240	255	255	255	255	255	270	270	270	270	270	300	300	6 (Riser) + 300 (U)	N/A	N/A

THROW PILLOWS

0024-00

Welted Square Pillow

Width: 24 Depth: 0 Height: 24

Weight: 5 / 5 lbs Cube: 0

Standard Filling: Blown Fiber Filling COM: 1.5 yards

D	E	F	G	H	J	K ^{COM}	L	M	N	O	P	Q	R	S	T	U	(# above U) *	S Nail	M Nail
210	210	210	210	210	225	225	225	225	225	240	240	240	240	240	270	270	6 (Riser) + 270 (U)	N/A	N/A

0066-BD

Welted Kidney Pillow

Width: 22 Depth: 0 Height: 11

Weight: 5 / 5 lbs Cube: 0

Standard Filling: Blendown COM: 1.5 yards

D	E	F	G	H	J	K ^{COM}	L	M	N	O	P	Q	R	S	T	U	(# above U) *	S Nail	M Nail
195	195	195	195	195	210	210	210	210	210	225	225	225	225	225	255	255	6 (Riser) + 255 (U)	N/A	N/A

0066-00

Welted Kidney Pillow

Width: 22 Depth: 0 Height: 11

Weight: 5 / 5 lbs Cube: 0

Standard Filling: Blown Fiber Filling COM: 1.5 yards

D	E	F	G	H	J	K ^{COM}	L	M	N	O	P	Q	R	S	T	U	(# above U) *	S Nail	M Nail
165	165	165	165	165	180	180	180	180	180	195	195	195	195	195	225	225	6 (Riser) + 225 (U)	N/A	N/A

0077-BD

Welted Kidney Pillow

Width: 16 Depth: 0 Height: 11

Weight: 5 / 5 lbs Cube: 0

Standard Filling: Blendown COM: 1.25 yards

D	E	F	G	H	J	K ^{COM}	L	M	N	O	P	Q	R	S	T	U	(# above U) *	S Nail	M Nail
180	180	180	180	180	195	195	195	195	195	210	210	210	210	210	225	225	3 (Riser) + 225 (U)	N/A	N/A

0077-00

Welted Kidney Pillow

Width: 16 Depth: 0 Height: 11

Weight: 5 / 5 lbs Cube: 0

Standard Filling: Blown Fiber Filling COM: 1.25 yards

D	E	F	G	H	J	K ^{COM}	L	M	N	O	P	Q	R	S	T	U	(# above U) *	S Nail	M Nail
150	150	150	150	150	165	165	165	165	165	180	180	180	180	180	195	195	3 (Riser) + 195 (U)	N/A	N/A

0079-BD

Welted Kidney Pillow

Width: 16 Depth: 0 Height: 9

Weight: 5 / 5 lbs Cube: 0

Standard Filling: Blendown COM: 1.25 yards

D	E	F	G	H	J	K ^{COM}	L	M	N	O	P	Q	R	S	T	U	(# above U) *	S Nail	M Nail
180	180	180	180	180	195	195	195	195	195	210	210	210	210	210	240	240	3 (Riser) + 240 (U)	N/A	N/A

0079-00

Welted Kidney Pillow

Width: 16 Depth: 0 Height: 9

Weight: 5 / 5 lbs Cube: 0

Standard Filling: Blown Fiber Filling COM: 1.25 yards

D	E	F	G	H	J	K ^{COM}	L	M	N	O	P	Q	R	S	T	U	(# above U) *	S Nail	M Nail
150	150	150	150	150	165	165	165	165	165	180	180	180	180	180	210	210	3 (Riser) + 210 (U)	N/A	N/A

THROW PILLOWS

0114-BD

Welted Square Mitered Pillow

Width: 14 Depth: 0 Height: 14

Weight: 5 / 5 lbs Cube: 0

Standard Filling: Blendown COM: 1.5 yards

D	E	F	G	H	J	K ^{COM}	L	M	N	O	P	Q	R	S	T	U	(# above U) *	S Nail	M Nail
225	225	225	225	225	240	240	240	240	240	255	255	255	255	255	300	300	6 (Riser) + 300 (U)	N/A	N/A

0114-00

Welted Square Mitered Pillow

Width: 14 Depth: 4 Height: 14

Weight: 5 / 5 lbs Cube: 0.45

Standard Filling: Blown Fiber Filling COM: 1.5 yards

D	E	F	G	H	J	K ^{COM}	L	M	N	O	P	Q	R	S	T	U	(# above U) *	S Nail	M Nail
195	195	195	195	195	210	210	210	210	210	225	225	225	225	225	270	270	6 (Riser) + 270 (U)	N/A	N/A

0116-BD

Welted Square Mitered Pillow

Width: 16 Depth: 5 Height: 16

Weight: 5 / 5 lbs Cube: 0.74

Standard Filling: Blendown COM: 1.75 yards

D	E	F	G	H	J	K ^{COM}	L	M	N	O	P	Q	R	S	T	U	(# above U) *	S Nail	M Nail
225	225	225	225	225	240	240	240	240	240	255	255	255	255	255	300	300	6 (Riser) + 300 (U)	N/A	N/A

0116-00

Welted Square Mitered Pillow

Width: 16 Depth: 5 Height: 16

Weight: 5 / 5 lbs Cube: 0.74

Standard Filling: Blown Fiber Filling COM: 1.75 yards

D	E	F	G	H	J	K ^{COM}	L	M	N	O	P	Q	R	S	T	U	(# above U) *	S Nail	M Nail
195	195	195	195	195	210	210	210	210	210	225	225	225	225	225	270	270	6 (Riser) + 270 (U)	N/A	N/A

0118-BD

Welted Square Mitered Pillow

Width: 18 Depth: 0 Height: 18

Weight: 5 / 5 lbs Cube: 0

Standard Filling: Blendown COM: 1.75 yards

D	E	F	G	H	J	K ^{COM}	L	M	N	O	P	Q	R	S	T	U	(# above U) *	S Nail	M Nail
240	240	240	240	240	255	255	255	255	255	270	270	270	270	270	300	300	6 (Riser) + 300 (U)	N/A	N/A

0118-00

Welted Square Mitered Pillow

Width: 18 Depth: 0 Height: 18

Weight: 5 / 5 lbs Cube: 0

Standard Filling: Blown Fiber Filling COM: 1.75 yards

D	E	F	G	H	J	K ^{COM}	L	M	N	O	P	Q	R	S	T	U	(# above U) *	S Nail	M Nail
210	210	210	210	210	225	225	225	225	225	240	240	240	240	240	270	270	6 (Riser) + 270 (U)	N/A	N/A

0120-BD

Welted Square Mitered Pillow

Width: 20 Depth: 0 Height: 20

Weight: 5 / 5 lbs Cube: 0

Standard Filling: Blendown COM: 1.75 yards

D	E	F	G	H	J	K ^{COM}	L	M	N	O	P	Q	R	S	T	U	(# above U) *	S Nail	M Nail
255	255	255	255	255	270	270	270	270	270	285	285	285	285	285	315	315	6 (Riser) + 315 (U)	N/A	N/A

THROW PILLOWS

0120-00

Welted Square Mitered Pillow

Width: 20 Depth: 0 Height: 20

Weight: 5 / 5 lbs Cube: 0

Standard Filling: Blown Fiber Filling COM: 1.75 yards

D	E	F	G	H	J	K ^{COM}	L	M	N	O	P	Q	R	S	T	U	(# above U) *	S Nail	M Nail
225	225	225	225	225	240	240	240	240	240	255	255	255	255	255	285	285	6 (Riser) + 285 (U)	N/A	N/A

0122-BD

Welted Square Mitered Pillow

Width: 22 Depth: 0 Height: 22

Weight: 5 / 5 lbs Cube: 0

Standard Filling: Blendown COM: 2 yards

D	E	F	G	H	J	K ^{COM}	L	M	N	O	P	Q	R	S	T	U	(# above U) *	S Nail	M Nail
270	270	270	270	270	285	285	285	285	285	300	300	300	300	300	330	330	6 (Riser) + 330 (U)	N/A	N/A

0122-00

Welted Square Mitered Pillow

Width: 22 Depth: 0 Height: 22

Weight: 5 / 5 lbs Cube: 0

Standard Filling: Blown Fiber Filling COM: 2 yards

D	E	F	G	H	J	K ^{COM}	L	M	N	O	P	Q	R	S	T	U	(# above U) *	S Nail	M Nail
240	240	240	240	240	255	255	255	255	255	270	270	270	270	270	300	300	6 (Riser) + 300 (U)	N/A	N/A

0124-BD

Welted Square Mitered Pillow

Width: 24 Depth: 0 Height: 24

Weight: 5 / 5 lbs Cube: 0

Standard Filling: Blendown COM: 2.25 yards

D	E	F	G	H	J	K ^{COM}	L	M	N	O	P	Q	R	S	T	U	(# above U) *	S Nail	M Nail
285	285	285	285	285	300	300	300	300	300	315	315	315	315	315	345	345	9 (Riser) + 345 (U)	N/A	N/A

0124-00

Welted Square Mitered Pillow

Width: 24 Depth: 0 Height: 24

Weight: 5 / 5 lbs Cube: 0

Standard Filling: Blown Fiber Filling COM: 2.25 yards

D	E	F	G	H	J	K ^{COM}	L	M	N	O	P	Q	R	S	T	U	(# above U) *	S Nail	M Nail
255	255	255	255	255	270	270	270	270	270	285	285	285	285	285	315	315	9 (Riser) + 315 (U)	N/A	N/A

UPHOLSTERY

BAT1-PK
RECLINATION
Battery Pack

Standard Pillows: N/A **Finish Req:** N
Standard Cushions: N/A **Standard Finish:** N/A
COM: N/A
Use with -PR, -PB, and -PH Power Recliners.

Width: 4 **Depth:** 6 **Height:** 3
AH: - **SH:** - **SD:** - **IW:** -
Weight: 3 / 4 lbs **Cube:** 0.1

D	E	F	G	H	J	K _{COM}	L	M	N	O	P	Q	R	S	T	U	(# above U) *	S Nail	M Nail
450	450	450	450	450	450	450	450	450	450	450	450	450	450	450	450	450	N/A (Riser) + 450 (U)	N/A	N/A

B077-01

Sparta Lounge Chair

Standard Pillows: N/A **Finish Req:** N
Standard Cushions: High Resiliency 40 **Standard Finish:** Bronze
COM: 5.5 yards
Only available in Bronze finish

Width: 30.5 **Depth:** 34.5 **Height:** 32
AH: 22 **SH:** 18 **SD:** 21 **IW:** 24
Weight: 60 / 74 lbs **Cube:** 29.69

D	E	F	G	H	J	K _{COM}	L	M	N	O	P	Q	R	S	T	U	(# above U) *	S Nail	M Nail
2325	2340	2355	2370	2385	2400	2415	2430	2445	2460	2475	2490	2505	2520	2535	2550	2565	15 (Riser) + 2565 (U)	N/A	N/A

B078-01

Sparta Lounge Chair

Standard Pillows: N/A **Finish Req:** N
Standard Cushions: High Resiliency 40 **Standard Finish:** Bronze
COM: 5.25 yards
Only available in Bronze finish

Width: 30.5 **Depth:** 34.5 **Height:** 32
AH: 22 **SH:** 18 **SD:** 21 **IW:** 24
Weight: 60 / 73 lbs **Cube:** 29.69

D	E	F	G	H	J	K _{COM}	L	M	N	O	P	Q	R	S	T	U	(# above U) *	S Nail	M Nail
2340	2355	2370	2385	2400	2415	2430	2445	2460	2475	2490	2505	2520	2535	2550	2565	2580	15 (Riser) + 2580 (U)	N/A	N/A

B091-C6

Nolita Counter Stool

Standard Pillows: N/A **Finish Req:** N
Standard Cushions: High Resiliency 40 **Standard Finish:** Bronze
COM: 2.75 yards
Only available in Bronze finish

Width: 28 **Depth:** 24.5 **Height:** 35.5
AH: 35.5 **SH:** 26 **SD:** 19 **IW:** 18
Weight: 34 / 47 lbs **Cube:** 21.65

D	E	F	G	H	J	K _{COM}	L	M	N	O	P	Q	R	S	T	U	(# above U) *	S Nail	M Nail
1890	1902	1914	1926	1938	1950	1962	1974	1986	1998	2010	2022	2034	2046	2058	2070	2082	12 (Riser) + 2082 (U)	N/A	N/A

B091-01

Nolita Occasional Chair

Standard Pillows: N/A **Finish Req:** N
Standard Cushions: High Resiliency 40 **Standard Finish:** Bronze
COM: 2.75 yards
Only available in Bronze finish

Width: 28 **Depth:** 24.5 **Height:** 28
AH: 28 **SH:** 19 **SD:** 19 **IW:** 18
Weight: 32 / 45 lbs **Cube:** 21.65

D	E	F	G	H	J	K _{COM}	L	M	N	O	P	Q	R	S	T	U	(# above U) *	S Nail	M Nail
1815	1827	1839	1851	1863	1875	1887	1899	1911	1923	1935	1947	1959	1971	1983	1995	2007	12 (Riser) + 2007 (U)	N/A	N/A

B091-06

Nolita Bar Stool

Standard Pillows: N/A **Finish Req:** N
Standard Cushions: High Resiliency 40 **Standard Finish:** Bronze
COM: 2.75 yards
Only available in Bronze finish

Width: 28 **Depth:** 24.5 **Height:** 39.5
AH: 39.5 **SH:** 30 **SD:** 19 **IW:** 18
Weight: 34 / 47 lbs **Cube:** 21.65

D	E	F	G	H	J	K _{COM}	L	M	N	O	P	Q	R	S	T	U	(# above U) *	S Nail	M Nail
1890	1902	1914	1926	1938	1950	1962	1974	1986	1998	2010	2022	2034	2046	2058	2070	2082	12 (Riser) + 2082 (U)	N/A	N/A

B098-C7

Ian Counter Stool

Standard Pillows: N/A **Finish Req:** N
Standard Cushions: High Resiliency 40 **Standard Finish:** Bronze
COM: 1.75 yards
Only available in Bronze finish

Width: 21 **Depth:** 26 **Height:** 41
AH: - **SH:** 26 **SD:** 19.5 **IW:** 21
Weight: 23 / 37 lbs **Cube:** 21.65

D	E	F	G	H	J	K _{COM}	L	M	N	O	P	Q	R	S	T	U	(# above U) *	S Nail	M Nail
1590	1596	1602	1608	1614	1620	1626	1632	1638	1644	1650	1656	1662	1668	1674	1680	1686	6 (Riser) + 1686 (U)	N/A	N/A

UPHOLSTERY

B098-05

Ian Side Chair

Standard Pillows: N/A **Finish Req:** N
Standard Cushions: High Resiliency 40 **Standard Finish:** Bronze
COM: 1.75 yards
 Only available in Bronze finish

Width: 21 **Depth:** 26 **Height:** 35.5
AH: - **SH:** 20.5 **SD:** 19.5 **IW:** 21
Weight: 23 / 36 lbs **Cube:** 21.65

D	E	F	G	H	J	K _{COM}	L	M	N	O	P	Q	R	S	T	U	(# above U) *	S Nail	M Nail
1545	1551	1557	1563	1569	1575	1581	1587	1593	1599	1605	1611	1617	1623	1629	1635	1641	6 (Riser) + 1641 (U)	N/A	N/A

B098-07

Ian Bar Stool

Standard Pillows: N/A **Finish Req:** N
Standard Cushions: High Resiliency 40 **Standard Finish:** Bronze
COM: 1.75 yards
 Only available in Bronze finish

Width: 21 **Depth:** 26 **Height:** 45
AH: - **SH:** 30 **SD:** 19.5 **IW:** 21
Weight: 25 / 40 lbs **Cube:** 24.14

D	E	F	G	H	J	K _{COM}	L	M	N	O	P	Q	R	S	T	U	(# above U) *	S Nail	M Nail
1590	1596	1602	1608	1614	1620	1626	1632	1638	1644	1650	1656	1662	1668	1674	1680	1686	6 (Riser) + 1686 (U)	N/A	N/A

B099-C7

Uma Counter Stool

Standard Pillows: N/A **Finish Req:** N
Standard Cushions: High Resiliency 55 **Standard Finish:** Bronze
COM: 1.75 yards
 Only available in Bronze finish

Width: 21 **Depth:** 26 **Height:** 41
AH: - **SH:** 26 **SD:** 19.5 **IW:** 21
Weight: 23 / 34 lbs **Cube:** 21.65

D	E	F	G	H	J	K _{COM}	L	M	N	O	P	Q	R	S	T	U	(# above U) *	S Nail	M Nail
1665	1671	1677	1683	1689	1695	1701	1707	1713	1719	1725	1731	1737	1743	1749	1755	1761	6 (Riser) + 1761 (U)	N/A	N/A

B099-05

Uma Side Chair

Standard Pillows: N/A **Finish Req:** N
Standard Cushions: High Resiliency 55 **Standard Finish:** Bronze
COM: 1.75 yards
 Only available in Bronze finish

Width: 21 **Depth:** 26 **Height:** 35.5
AH: - **SH:** 20.5 **SD:** 19.5 **IW:** 21
Weight: 23 / 33 lbs **Cube:** 21.65

D	E	F	G	H	J	K _{COM}	L	M	N	O	P	Q	R	S	T	U	(# above U) *	S Nail	M Nail
1605	1611	1617	1623	1629	1635	1641	1647	1653	1659	1665	1671	1677	1683	1689	1695	1701	6 (Riser) + 1701 (U)	N/A	N/A

B099-07

Uma Bar Stool

Standard Pillows: N/A **Finish Req:** N
Standard Cushions: High Resiliency 55 **Standard Finish:** Bronze
COM: 1.75 yards
 Only available in Bronze finish

Width: 21 **Depth:** 26 **Height:** 45
AH: - **SH:** 30 **SD:** 19.5 **IW:** 21
Weight: 25 / 38 lbs **Cube:** 24.14

D	E	F	G	H	J	K _{COM}	L	M	N	O	P	Q	R	S	T	U	(# above U) *	S Nail	M Nail
1665	1671	1677	1683	1689	1695	1701	1707	1713	1719	1725	1731	1737	1743	1749	1755	1761	6 (Riser) + 1761 (U)	N/A	N/A

B100-C7

Ian Counter Stool

Standard Pillows: N/A **Finish Req:** N
Standard Cushions: High Resiliency 40 **Standard Finish:** Bright Brass
COM: 1.75 yards
 Only available in Bright Brass finish

Width: 21 **Depth:** 26 **Height:** 41
AH: - **SH:** 26 **SD:** 19.5 **IW:** 21
Weight: 23 / 37 lbs **Cube:** 21.65

D	E	F	G	H	J	K _{COM}	L	M	N	O	P	Q	R	S	T	U	(# above U) *	S Nail	M Nail
1605	1611	1617	1623	1629	1635	1641	1647	1653	1659	1665	1671	1677	1683	1689	1695	1701	6 (Riser) + 1701 (U)	N/A	N/A

B100-05

Ian Side Chair

Standard Pillows: N/A **Finish Req:** N
Standard Cushions: High Resiliency 40 **Standard Finish:** Bright Brass
COM: 1.75 yards
 Only available in Bright Brass finish

Width: 21 **Depth:** 26 **Height:** 35.5
AH: - **SH:** 20.5 **SD:** 19.5 **IW:** 21
Weight: 23 / 33 lbs **Cube:** 21.65

D	E	F	G	H	J	K _{COM}	L	M	N	O	P	Q	R	S	T	U	(# above U) *	S Nail	M Nail
1530	1536	1542	1548	1554	1560	1566	1572	1578	1584	1590	1596	1602	1608	1614	1620	1626	6 (Riser) + 1626 (U)	N/A	N/A

UPHOLSTERY

B101-C7

Uma Counter Stool

Standard Pillows: N/A **Finish Req:** N
Standard Cushions: High Resiliency 55 **Standard Finish:** Bright Brass
COM: 1.75 yards
 Only available in Bright Brass finish

Width: 21 **Depth:** 26 **Height:** 41
AH: - **SH:** 26 **SD:** 19.5 **IW:** 21
Weight: 23 / 34 lbs **Cube:** 19.6

D	E	F	G	H	J	K _{COM}	L	M	N	O	P	Q	R	S	T	U	(# above U) *	S Nail	M Nail
1650	1656	1662	1668	1674	1680	1686	1692	1698	1704	1710	1716	1722	1728	1734	1740	1746	6 (Riser) + 1746 (U)	N/A	N/A

B101-05

Uma Side Chair

Standard Pillows: N/A **Finish Req:** N
Standard Cushions: High Resiliency 55 **Standard Finish:** Bright Brass
COM: 1.75 yards
 Only available in Bright Brass finish

Width: 21 **Depth:** 26 **Height:** 35.5
AH: - **SH:** 20.5 **SD:** 19.5 **IW:** 21
Weight: 23 / 33 lbs **Cube:** 21.65

D	E	F	G	H	J	K _{COM}	L	M	N	O	P	Q	R	S	T	U	(# above U) *	S Nail	M Nail
1605	1611	1617	1623	1629	1635	1641	1647	1653	1659	1665	1671	1677	1683	1689	1695	1701	6 (Riser) + 1701 (U)	N/A	N/A

FURR-Y1

FURRY COLLECTION Furry Rectangular Ottoman

Standard Pillows: N/A **Finish Req:** N
Standard Cushions: High Resiliency 40 **Standard Finish:** Graphite
COM: 1.75 yards

Width: 30 **Depth:** 20 **Height:** 19
AH: - **SH:** - **SD:** - **IW:** -
Weight: 15 / 24 lbs **Cube:** 10.77

D	E	F	G	H	J	K _{COM}	L	M	N	O	P	Q	R	S	T	U	(# above U) *	S Nail	M Nail
630	636	642	648	654	660	666	672	678	684	690	696	702	708	714	720	726	6 (Riser) + 726 (U)	N/A	N/A

FURR-Y2

FURRY COLLECTION Furry Round Ottoman

Standard Pillows: N/A **Finish Req:** N
Standard Cushions: High Resiliency 40 **Standard Finish:** Graphite
COM: 1.5 yards

Width: 20 **Depth:** 20 **Height:** 19.5
AH: - **SH:** - **SD:** - **IW:** -
Weight: 12 / 21 lbs **Cube:** 10.77

D	E	F	G	H	J	K _{COM}	L	M	N	O	P	Q	R	S	T	U	(# above U) *	S Nail	M Nail
630	636	642	648	654	660	666	672	678	684	690	696	702	708	714	720	726	6 (Riser) + 726 (U)	N/A	N/A

FURR-Y3

FURRY COLLECTION Furry Ottoman

Standard Pillows: N/A **Finish Req:** N
Standard Cushions: High Resiliency 40 **Standard Finish:** Acrylic
COM: 2 yards

Width: 35 **Depth:** 12.25 **Height:** 18
AH: - **SH:** 18 **SD:** - **IW:** -
Weight: 15 / 29 lbs **Cube:** 15.26

D	E	F	G	H	J	K _{COM}	L	M	N	O	P	Q	R	S	T	U	(# above U) *	S Nail	M Nail
990	996	1002	1008	1014	1020	1026	1032	1038	1044	1050	1056	1062	1068	1074	1080	1086	6 (Riser) + 1086 (U)	N/A	N/A

F012-C6

READY-TO-SHIP UPHOLSTERY Gabriella Counter Stool

Standard Pillows: N/A **Finish Req:** N
Standard Cushions: High Resiliency 40 **Standard Finish:** TAHITIAN PEARL
COM: N/A
 Married in Tahitian Pearl with Black Steel accents and performance fabric 3343 Ecu.

Width: 23 **Depth:** 22.75 **Height:** 34
AH: - **SH:** - **SD:** - **IW:** -
Weight: 71 / 71 lbs **Cube:** 10.29

D	E	F	G	H	J	K _{COM}	L	M	N	O	P	Q	R	S	T	U	(# above U) *	S Nail	M Nail
1347	N/A	N/A	N/A	N/A	N/A	N/A	N/A	N/A	N/A	N/A	N/A	N/A	N/A	N/A	N/A	N/A	N/A (Riser) + N/A (U)	N/A	N/A

F012-04

READY-TO-SHIP UPHOLSTERY Gabriella Arm Chair

Standard Pillows: N/A **Finish Req:** N
Standard Cushions: High Resiliency 40 **Standard Finish:** TAHITIAN PEARL
COM: N/A
 Married in Tahitian Pearl with Black Steel accents and performance fabric 3343 Ecu.

Width: 23.25 **Depth:** 23 **Height:** 28
AH: 25 **SH:** 19.25 **SD:** 20 **IW:** 21
Weight: 62 / 62 lbs **Cube:** 8.66

D	E	F	G	H	J	K _{COM}	L	M	N	O	P	Q	R	S	T	U	(# above U) *	S Nail	M Nail
1197	N/A	N/A	N/A	N/A	N/A	N/A	N/A	N/A	N/A	N/A	N/A	N/A	N/A	N/A	N/A	N/A	N/A (Riser) + N/A (U)	N/A	N/A

UPHOLSTERY

F012-06

READY-TO-SHIP UPHOLSTERY

Gabriella Bar Stool

Width: 23 Depth: 22.75 Height: 39

AH: - SH: - SD: - IW: -

Weight: 82 / 82 lbs Cube: 11.8

Standard Pillows: N/A Finish Req: N

Standard Cushions: High Resiliency 40 Standard Finish: TAHITIAN PEARL

COM: N/A

Married in Tahitian Pearl with Black Steel accents and performance fabric 3343 Ecu.

D	E	F	G	H	J	K ^{COM}	L	M	N	O	P	Q	R	S	T	U	(# above U) *	S Nail	M Nail
1347	N/A	N/A	N/A	N/A	N/A	N/A	N/A	N/A	N/A	N/A	N/A	N/A	N/A	N/A	N/A	N/A	N/A (Riser) + N/A (U)	N/A	N/A

F013-C6

READY-TO-SHIP UPHOLSTERY

Portside Counter Stool

Width: 23.75 Depth: 23 Height: 41.25

AH: - SH: 26 SD: 19.5 IW: 19.75

Weight: 22 / 33 lbs Cube: 17.77

Standard Pillows: N/A Finish Req: N

Standard Cushions: High Resiliency 30 Standard Finish: Natural

COM: N/A

Married in Linen in a Natural Mango finish with a Raffia back. Features natural cane accents that was handwoven using the peel of natural rattan. As with any natural product, nature's imperfections and hallmarks will be present in the cane materials. Cane is a handcrafted product dating back to the Ancient Egyptians.

D	E	F	G	H	J	K ^{COM}	L	M	N	O	P	Q	R	S	T	U	(# above U) *	S Nail	M Nail
1965	N/A	N/A	N/A	N/A	N/A	N/A	N/A	N/A	N/A	N/A	N/A	N/A	N/A	N/A	N/A	N/A	N/A (Riser) + N/A (U)	N/A	N/A

F013-04

READY-TO-SHIP UPHOLSTERY

Portside Arm Chair

Width: 23 Depth: 24.25 Height: 35

AH: 24.5 SH: 19.25 SD: 21.5 IW: 19.75

Weight: 31 / 31 lbs Cube: 15.89

Standard Pillows: N/A Finish Req: N

Standard Cushions: High Resiliency 30 Standard Finish: Natural

COM: N/A

Married in Linen in a Natural Mango finish with a Raffia back. Features natural cane accents that was handwoven using the peel of natural rattan. As with any natural product, nature's imperfections and hallmarks will be present in the cane materials. Cane is a handcrafted product dating back to the Ancient Egyptians.

D	E	F	G	H	J	K ^{COM}	L	M	N	O	P	Q	R	S	T	U	(# above U) *	S Nail	M Nail
1740	N/A	N/A	N/A	N/A	N/A	N/A	N/A	N/A	N/A	N/A	N/A	N/A	N/A	N/A	N/A	N/A	N/A (Riser) + N/A (U)	N/A	N/A

F013-05

READY-TO-SHIP UPHOLSTERY

Portside Side Chair

Width: 21 Depth: 24.5 Height: 35

AH: - SH: 19 SD: 21.5 IW: 21

Weight: 28 / 28 lbs Cube: 15.23

Standard Pillows: N/A Finish Req: N

Standard Cushions: High Resiliency 30 Standard Finish: Natural

COM: N/A

Married in Linen in a Natural Mango finish with a Raffia back. Features natural cane accents that was handwoven using the peel of natural rattan. As with any natural product, nature's imperfections and hallmarks will be present in the cane materials. Cane is a handcrafted product dating back to the Ancient Egyptians.

D	E	F	G	H	J	K ^{COM}	L	M	N	O	P	Q	R	S	T	U	(# above U) *	S Nail	M Nail
1740	N/A	N/A	N/A	N/A	N/A	N/A	N/A	N/A	N/A	N/A	N/A	N/A	N/A	N/A	N/A	N/A	N/A (Riser) + N/A (U)	N/A	N/A

F013-06

READY-TO-SHIP UPHOLSTERY

Portside Bar Stool

Width: 23.75 Depth: 23 Height: 45.25

AH: - SH: 30 SD: 19.5 IW: 19.75

Weight: 22 / 22 lbs Cube: 19.5

Standard Pillows: N/A Finish Req: N

Standard Cushions: High Resiliency 30 Standard Finish: Natural

COM: N/A

Married in Linen in a Natural Mango finish with a Raffia back. Features natural cane accents that was handwoven using the peel of natural rattan. As with any natural product, nature's imperfections and hallmarks will be present in the cane materials. Cane is a handcrafted product dating back to the Ancient Egyptians.

D	E	F	G	H	J	K ^{COM}	L	M	N	O	P	Q	R	S	T	U	(# above U) *	S Nail	M Nail
1965	N/A	N/A	N/A	N/A	N/A	N/A	N/A	N/A	N/A	N/A	N/A	N/A	N/A	N/A	N/A	N/A	N/A (Riser) + N/A (U)	N/A	N/A

F620-20

READY-TO-SHIP UPHOLSTERY

Huntington Square Cocktail Ottoman

Width: 52 Depth: 52 Height: 18

AH: - SH: - SD: - IW: -

Weight: 53 / 53 lbs Cube: 28.16

Standard Pillows: N/A Finish Req: N

Standard Cushions: N/A Standard Finish: N/A

COM: N/A

Married in 9810-72 Willow.

D	E	F	G	H	J	K ^{COM}	L	M	N	O	P	Q	R	S	T	U	(# above U) *	S Nail	M Nail
2097	N/A	N/A	N/A	N/A	N/A	N/A	N/A	N/A	N/A	N/A	N/A	N/A	N/A	N/A	N/A	N/A	N/A (Riser) + N/A (U)	N/A	N/A

F621-20

READY-TO-SHIP UPHOLSTERY

Huntington Rectangular Cocktail Ottoman

Width: 50 Depth: 30 Height: 18

AH: - SH: - SD: - IW: -

Weight: 33 / 33 lbs Cube: 15.62

Standard Pillows: N/A Finish Req: N

Standard Cushions: N/A Standard Finish: N/A

COM: N/A

Married in 9810-72 Willow.

D	E	F	G	H	J	K ^{COM}	L	M	N	O	P	Q	R	S	T	U	(# above U) *	S Nail	M Nail
1647	N/A	N/A	N/A	N/A	N/A	N/A	N/A	N/A	N/A	N/A	N/A	N/A	N/A	N/A	N/A	N/A	N/A (Riser) + N/A (U)	N/A	N/A

UPHOLSTERY

F840-04-O

READY-TO-SHIP UPHOLSTERY

Lila Arm Chair

Width: 23.25 Depth: 24.5 Height: 39

AH: - SH: 19 SD: 18.5 IW: 23.75

Weight: 63 / 63 lbs Cube: 26.56

Standard Pillows: N/A Finish Req: N

Standard Cushions: High Resiliency 40 Standard Finish: bavarian cream

COM: N/A

Married in Fabric 9953 Oyster with Bavarian Creme and gold striping. Standard two packed per box.

D	E	F	G	H	J	K ^{COM}	L	M	N	O	P	Q	R	S	T	U	(# above U) *	S Nail	M Nail
1320	N/A	N/A	N/A	N/A	N/A	N/A	N/A	N/A	N/A	N/A	N/A	N/A	N/A	N/A	N/A	N/A	N/A (Riser) + N/A (U)	N/A	N/A

F840-04-S

READY-TO-SHIP UPHOLSTERY

Lila Arm Chair

Width: 23.25 Depth: 24.5 Height: 39

AH: 24.25 SH: 19 SD: 18.5 IW: 23.75

Weight: 63 / 63 lbs Cube: 26.56

Standard Pillows: N/A Finish Req: N

Standard Cushions: High Resiliency 40 Standard Finish: bavarian cream

COM: N/A

Married in 9953 Sand with Bavarian Creme finish and gold striping. Standard two packed per box.

D	E	F	G	H	J	K ^{COM}	L	M	N	O	P	Q	R	S	T	U	(# above U) *	S Nail	M Nail
1320	N/A	N/A	N/A	N/A	N/A	N/A	N/A	N/A	N/A	N/A	N/A	N/A	N/A	N/A	N/A	N/A	N/A (Riser) + N/A (U)	N/A	N/A

F840-05-O

READY-TO-SHIP UPHOLSTERY

Lila Side Chair

Width: 23.25 Depth: 24.5 Height: 39

AH: - SH: 19 SD: 18.5 IW: 23.75

Weight: 27 / 57 lbs Cube: 15.74

Standard Pillows: N/A Finish Req: N

Standard Cushions: High Resiliency 40 Standard Finish: bavarian cream

COM: N/A

Married in 9953 Oyster with Bavarian Creme finish and gold striping. Standard two packed per box.

D	E	F	G	H	J	K ^{COM}	L	M	N	O	P	Q	R	S	T	U	(# above U) *	S Nail	M Nail
1197	N/A	N/A	N/A	N/A	N/A	N/A	N/A	N/A	N/A	N/A	N/A	N/A	N/A	N/A	N/A	N/A	N/A (Riser) + N/A (U)	N/A	N/A

F840-05-S

READY-TO-SHIP UPHOLSTERY

Lila Side Chair

Width: 23.25 Depth: 24.5 Height: 39

AH: - SH: 19 SD: 18.5 IW: 23.75

Weight: 27 / 57 lbs Cube: 15.74

Standard Pillows: N/A Finish Req: N

Standard Cushions: High Resiliency 40 Standard Finish: bavarian cream

COM: N/A

Married in 9953 Sand with Bavarian Creme finish and gold striping. Standard two packed per box.

D	E	F	G	H	J	K ^{COM}	L	M	N	O	P	Q	R	S	T	U	(# above U) *	S Nail	M Nail
1197	N/A	N/A	N/A	N/A	N/A	N/A	N/A	N/A	N/A	N/A	N/A	N/A	N/A	N/A	N/A	N/A	N/A (Riser) + N/A (U)	N/A	N/A

F842-04

READY-TO-SHIP UPHOLSTERY

Ava Arm Chair

Width: 22.5 Depth: 25.75 Height: 40.5

AH: 24.5 SH: 19.5 SD: 20 IW: 20

Weight: 70 / 70 lbs Cube: 17.77

Standard Pillows: N/A Finish Req: N

Standard Cushions: High Resiliency 40 Standard Finish: Almond Buff

COM: N/A

Married in Fabric 8796 Alabaster with Almond Buff finish. Features natural cane accents that was handwoven using the peel of natural rattan. As with any natural product, nature's imperfections and hallmarks will be present in the cane materials. Cane is a handcrafted product dating back to the Ancient Egyptians. Standard two packed per box.

D	E	F	G	H	J	K ^{COM}	L	M	N	O	P	Q	R	S	T	U	(# above U) *	S Nail	M Nail
1320	N/A	N/A	N/A	N/A	N/A	N/A	N/A	N/A	N/A	N/A	N/A	N/A	N/A	N/A	N/A	N/A	N/A (Riser) + N/A (U)	N/A	N/A

F842-05

READY-TO-SHIP UPHOLSTERY

Ava Side Chair

Width: 22.5 Depth: 25.75 Height: 40.5

AH: 24.5 SH: 19.5 SD: 20 IW: 20

Weight: 72 / 72 lbs Cube: 17.77

Standard Pillows: N/A Finish Req: N

Standard Cushions: High Resiliency 40 Standard Finish: Almond Buff

COM: N/A

Married in Fabric 8796 Alabaster with Almond Buff finish. Features natural cane accents that was handwoven using the peel of natural rattan. As with any natural product, nature's imperfections and hallmarks will be present in the cane materials. Cane is a handcrafted product dating back to the Ancient Egyptians. Standard two packed per box.

D	E	F	G	H	J	K ^{COM}	L	M	N	O	P	Q	R	S	T	U	(# above U) *	S Nail	M Nail
1197	N/A	N/A	N/A	N/A	N/A	N/A	N/A	N/A	N/A	N/A	N/A	N/A	N/A	N/A	N/A	N/A	N/A (Riser) + N/A (U)	Std.	N/A

N077-01

YOUR CHOICE LEATHER

Sparta Lounge Chair

Width: 30.5 Depth: 34.5 Height: 32

AH: 22 SH: 18 SD: 21 IW: 24

Weight: 60 / 74 lbs Cube: 29.69

Standard Pillows: N/A Finish Req: N

Standard Cushions: High Resiliency 40 Standard Finish: Nickel

COM: 5.5 yards

Only available in Nickel finish

D	E	F	G	H	J	K ^{COM}	L	M	N	O	P	Q	R	S	T	U	(# above U) *	S Nail	M Nail
2325	2340	2355	2370	2385	2400	2415	2430	2445	2460	2475	2490	2505	2520	2535	2550	2565	15 (Riser) + 2565 (U)	N/A	N/A

UPHOLSTERY

N078-01

Sparta Lounge Chair

Standard Pillows: N/A **Finish Req:** N
Standard Cushions: High Resiliency 40 **Standard Finish:** Nickel
COM: 5.5 yards
 Only available in Nickel finish

Width: 30.5 **Depth:** 34.5 **Height:** 32
AH: 22 **SH:** 18 **SD:** 21 **IW:** 24
Weight: 60 / 74 lbs **Cube:** 29.69

D	E	F	G	H	J	K COM	L	M	N	O	P	Q	R	S	T	U	(# above U) *	S Nail	M Nail
2385	2400	2415	2430	2445	2460	2475	2490	2505	2520	2535	2550	2565	2580	2595	2610	2625	15 (Riser) + 2625 (U)	N/A	N/A

N098-M7

Uma Billiard Bar Stool

Standard Pillows: N/A **Finish Req:** N
Standard Cushions: High Resiliency 40 **Standard Finish:** Nickel
COM: 1.75 yards
 Only available in Nickel finish with standard gas lift

Width: 21 **Depth:** 26 **Height:** 42.5
AH: - **SH:** 25.5 **SD:** 20 **IW:** -
Weight: 36 / 47 lbs **Cube:** 24.14

D	E	F	G	H	J	K COM	L	M	N	O	P	Q	R	S	T	U	(# above U) *	S Nail	M Nail
2025	2031	2037	2043	2049	2055	2061	2067	2073	2079	2085	2091	2097	2103	2109	2115	2121	6 (Riser) + 2121 (U)	N/A	N/A

N099-M7

Uma Billiard Bar Stool

Standard Pillows: N/A **Finish Req:** N
Standard Cushions: High Resiliency 40 **Standard Finish:** Nickel
COM: 1.75 yards
 Only available in Nickel finish with standard gas lift

Width: 21 **Depth:** 26 **Height:** 42.5
AH: - **SH:** 25.5 **SD:** 20 **IW:** -
Weight: 36 / 47 lbs **Cube:** 21.65

D	E	F	G	H	J	K COM	L	M	N	O	P	Q	R	S	T	U	(# above U) *	S Nail	M Nail
2100	2106	2112	2118	2124	2130	2136	2142	2148	2154	2160	2166	2172	2178	2184	2190	2196	6 (Riser) + 2196 (U)	N/A	N/A

1002-01

Chico Lounge Chair

Standard Pillows: N/A **Finish Req:** Y
Standard Cushions: High Resiliency 40 **Standard Finish:** N/A
COM: 4.25 yards

Width: 29 **Depth:** 31.5 **Height:** 34.5
AH: 25.5 **SH:** 19 **SD:** 20.5 **IW:** 23
Weight: 40 / 40 lbs **Cube:** 18.23

D	E	F	G	H	J	K COM	L	M	N	O	P	Q	R	S	T	U	(# above U) *	S Nail	M Nail
1875	1887	1899	1911	1923	1935	1947	1959	1971	1983	1995	2007	2019	2031	2043	2055	2067	12 (Riser) + 2067 (U)	105	N/A

1003-01

Blythe Lounge Chair

Standard Pillows: N/A **Finish Req:** Y
Standard Cushions: High Resiliency 40 **Standard Finish:** N/A
COM: 3.75 yards

Width: 31 **Depth:** 32 **Height:** 35
AH: 24 **SH:** 19 **SD:** 21 **IW:** 23
Weight: 33 / 33 lbs **Cube:** 20.09

D	E	F	G	H	J	K COM	L	M	N	O	P	Q	R	S	T	U	(# above U) *	S Nail	M Nail
1650	1662	1674	1686	1698	1710	1722	1734	1746	1758	1770	1782	1794	1806	1818	1830	1842	12 (Riser) + 1842 (U)	90	N/A

1014-35

Troy Office Swivel Chair

Standard Pillows: N/A **Finish Req:** Y
Standard Cushions: High Resiliency 40 **Standard Finish:** N/A
COM: 2.75 yards
 Standard with a gas lift.

Width: 27.5 **Depth:** 29.5 **Height:** 37.5
AH: - **SH:** - **SD:** 19.5 **IW:** 21
Weight: 60 / 70 lbs **Cube:** 21.65

D	E	F	G	H	J	K COM	L	M	N	O	P	Q	R	S	T	U	(# above U) *	S Nail	M Nail
1695	1704	1713	1722	1731	1740	1749	1758	1767	1776	1785	1794	1803	1812	1821	1830	1839	9 (Riser) + 1839 (U)	45	60

1015-05

Clark Side Chair

Standard Pillows: N/A **Finish Req:** Y
Standard Cushions: High Resiliency 40 **Standard Finish:** N/A
COM: 2.75 yards

Width: 19.5 **Depth:** 26 **Height:** 40
AH: - **SH:** 20 **SD:** 18 **IW:** 20
Weight: 25 / 35 lbs **Cube:** 15.74

D	E	F	G	H	J	K COM	L	M	N	O	P	Q	R	S	T	U	(# above U) *	S Nail	M Nail
1125	1134	1143	1152	1161	1170	1179	1188	1197	1206	1215	1224	1233	1242	1251	1260	1269	9 (Riser) + 1269 (U)	45	60

UPHOLSTERY

1015-07

Clark Bar Stool

Standard Pillows: N/A Finish Req: Y
 Standard Cushions: High Resiliency 40 Standard Finish: N/A
 COM: 2.75 yards

Width: 19.5 Depth: 23 Height: 45.5
 AH: - SH: 30 SD: 16 IW: 19.5
 Weight: 23 / 36 lbs Cube: 19.6

D	E	F	G	H	J	K COM	L	M	N	O	P	Q	R	S	T	U	(# above U) *	S Nail	M Nail
1230	1239	1248	1257	1266	1275	1284	1293	1302	1311	1320	1329	1338	1347	1356	1365	1374	9 (Riser) + 1374 (U)	45	60

1019-A4

Thayer Occasional Chair

Standard Pillows: N/A Finish Req: Y
 Standard Cushions: High Resiliency 40 Standard Finish: N/A
 COM: 2.25 yards

Width: 24.5 Depth: 23 Height: 30
 AH: 24.5 SH: 18.5 SD: 18 IW: 19.5
 Weight: 25 / 35 lbs Cube: 15.74

D	E	F	G	H	J	K COM	L	M	N	O	P	Q	R	S	T	U	(# above U) *	S Nail	M Nail
1272	1278	1284	1290	1296	1302	1308	1314	1320	1326	1332	1338	1344	1350	1356	1362	1368	6 (Riser) + 1368 (U)	Std.	N/A

1019-01

Thayer Occasional Chair

Standard Pillows: N/A Finish Req: Y
 Standard Cushions: High Resiliency 40 Standard Finish: N/A
 COM: 2.25 yards

Width: 24.5 Depth: 23 Height: 30
 AH: 24.5 SH: 18.5 SD: 18 IW: 19.5
 Weight: 25 / 30 lbs Cube: 15.74

D	E	F	G	H	J	K COM	L	M	N	O	P	Q	R	S	T	U	(# above U) *	S Nail	M Nail
1200	1206	1212	1218	1224	1230	1236	1242	1248	1254	1260	1266	1272	1278	1284	1290	1296	6 (Riser) + 1296 (U)	Std.	N/A

1021-04

Bedford Arm Chair

Standard Pillows: N/A Finish Req: Y
 Standard Cushions: High Resiliency 40 Standard Finish: N/A
 COM: 3.25 yards

Width: 24 Depth: 25.5 Height: 40
 AH: 25.5 SH: 20 SD: 18 IW: 20.5
 Weight: 25 / 40 lbs Cube: 21.65

D	E	F	G	H	J	K COM	L	M	N	O	P	Q	R	S	T	U	(# above U) *	S Nail	M Nail
1305	1314	1323	1332	1341	1350	1359	1368	1377	1386	1395	1404	1413	1422	1431	1440	1449	9 (Riser) + 1449 (U)	45	60

1021-05

Bedford Side Chair

Standard Pillows: N/A Finish Req: Y
 Standard Cushions: High Resiliency 40 Standard Finish: N/A
 COM: 3.25 yards

Width: 22.5 Depth: 25.5 Height: 40
 AH: - SH: 20 SD: 18 IW: 22.5
 Weight: 30 / 41 lbs Cube: 15.74

D	E	F	G	H	J	K COM	L	M	N	O	P	Q	R	S	T	U	(# above U) *	S Nail	M Nail
1275	1284	1293	1302	1311	1320	1329	1338	1347	1356	1365	1374	1383	1392	1401	1410	1419	9 (Riser) + 1419 (U)	60	75

1029-35

Eaton Office Swivel Chair

Standard Pillows: N/A Finish Req: Y
 Standard Cushions: High Resiliency 40 Standard Finish: N/A
 COM: 4 yards
 Standard with a gas lift.

Width: 25 Depth: 30.5 Height: 40.5
 AH: - SH: - SD: 20 IW: 20
 Weight: 65 / 75 lbs Cube: 26.89

D	E	F	G	H	J	K COM	L	M	N	O	P	Q	R	S	T	U	(# above U) *	S Nail	M Nail
1845	1857	1869	1881	1893	1905	1917	1929	1941	1953	1965	1977	1989	2001	2013	2025	2037	12 (Riser) + 2037 (U)	N/A	N/A

1036-01

Cabot Occasional Chair

Standard Pillows: N/A Finish Req: Y
 Standard Cushions: High Resiliency 40 Standard Finish: N/A
 COM: 2.75 yards

Width: 25 Depth: 28.5 Height: 40.5
 AH: 26 SH: 19.5 SD: 20 IW: 20.5
 Weight: 30 / 35 lbs Cube: 21.65

D	E	F	G	H	J	K COM	L	M	N	O	P	Q	R	S	T	U	(# above U) *	S Nail	M Nail
1350	1359	1368	1377	1386	1395	1404	1413	1422	1431	1440	1449	1458	1467	1476	1485	1494	9 (Riser) + 1494 (U)	45	60

UPHOLSTERY

1046-35

Plaza 66 Office Swivel Chair

Standard Pillows: N/A **Finish Req:** N
Standard Cushions: Ultra Plush **Standard Finish:** Nickel
COM: 3.75 yards
 Standard with a gas lift and a locking tilt mechanism.

Width: 28.25 **Depth:** 31.75 **Height:** 43
AH: - **SH:** - **SD:** 20.75 **IW:** 19.5
Weight: 71 / 81 lbs **Cube:** 22.31

D	E	F	G	H	J	K ^{COM}	L	M	N	O	P	Q	R	S	T	U	(# above U) *	S Nail	M Nail
2295	2307	2319	2331	2343	2355	2367	2379	2391	2403	2415	2427	2439	2451	2463	2475	2487	12 (Riser) + 2487 (U)	Std.	N/A

1049-35

Taft Office Swivel Chair

Standard Pillows: N/A **Finish Req:** Y
Standard Cushions: High Resiliency 40 **Standard Finish:** N/A
COM: 3.25 yards
 Standard with a gas lift.

Width: 24.5 **Depth:** 30.5 **Height:** 36
AH: 25.5 **SH:** 17 **SD:** 22 **IW:** 20
Weight: 50 / 60 lbs **Cube:** 21.65

D	E	F	G	H	J	K ^{COM}	L	M	N	O	P	Q	R	S	T	U	(# above U) *	S Nail	M Nail
1860	1869	1878	1887	1896	1905	1914	1923	1932	1941	1950	1959	1968	1977	1986	1995	2004	9 (Riser) + 2004 (U)	Std.	N/A

1059-35

Stanford Office Swivel Chair

Standard Pillows: N/A **Finish Req:** Y
Standard Cushions: High Resiliency 40 **Standard Finish:** N/A
COM: 3.5 yards
 Standard with a gas lift.

Width: 25 **Depth:** 31 **Height:** 36.5
AH: - **SH:** - **SD:** 21 **IW:** 19
Weight: 55 / 65 lbs **Cube:** 23.22

D	E	F	G	H	J	K ^{COM}	L	M	N	O	P	Q	R	S	T	U	(# above U) *	S Nail	M Nail
1965	1974	1983	1992	2001	2010	2019	2028	2037	2046	2055	2064	2073	2082	2091	2100	2109	9 (Riser) + 2109 (U)	Std.	N/A

1073-05

Logan Side Chair

Standard Pillows: N/A **Finish Req:** N
Standard Cushions: High Resiliency 40 **Standard Finish:** traditional
COM: 4 yards

Width: 19.5 **Depth:** 26 **Height:** 40
AH: - **SH:** 20 **SD:** 18 **IW:** 20
Weight: 25 / 35 lbs **Cube:** 15.74

D	E	F	G	H	J	K ^{COM}	L	M	N	O	P	Q	R	S	T	U	(# above U) *	S Nail	M Nail
1395	1407	1419	1431	1443	1455	1467	1479	1491	1503	1515	1527	1539	1551	1563	1575	1587	12 (Riser) + 1587 (U)	N/A	N/A

1082-A4

Addison Occasional Chair

Standard Pillows: N/A **Finish Req:** Y
Standard Cushions: High Resiliency 40 **Standard Finish:** N/A
COM: 2.75 yards

Width: 24.5 **Depth:** 28.5 **Height:** 40.5
AH: 26.5 **SH:** 19.5 **SD:** 19.5 **IW:** 20
Weight: 30 / 35 lbs **Cube:** 21.65

D	E	F	G	H	J	K ^{COM}	L	M	N	O	P	Q	R	S	T	U	(# above U) *	S Nail	M Nail
1392	1401	1410	1419	1428	1437	1446	1455	1464	1473	1482	1491	1500	1509	1518	1527	1536	9 (Riser) + 1536 (U)	45	60

1082-01

Addison Occasional Chair

Standard Pillows: N/A **Finish Req:** Y
Standard Cushions: High Resiliency 40 **Standard Finish:** N/A
COM: 2.75 yards

Width: 24.5 **Depth:** 28.5 **Height:** 40.5
AH: 26.5 **SH:** 19.5 **SD:** 19.5 **IW:** 20
Weight: 30 / 35 lbs **Cube:** 21.65

D	E	F	G	H	J	K ^{COM}	L	M	N	O	P	Q	R	S	T	U	(# above U) *	S Nail	M Nail
1320	1329	1338	1347	1356	1365	1374	1383	1392	1401	1410	1419	1428	1437	1446	1455	1464	9 (Riser) + 1464 (U)	45	60

1083-35

Wendell Office Swivel Chair

Standard Pillows: N/A **Finish Req:** Y
Standard Cushions: High Resiliency 30 **Standard Finish:** N/A
COM: 6.25 yards
 Standard with a gas lift.

Width: 30 **Depth:** 35.5 **Height:** 46.5
AH: - **SH:** - **SD:** 18 **IW:** 19.5
Weight: 85 / 95 lbs **Cube:** 34.38

D	E	F	G	H	J	K ^{COM}	L	M	N	O	P	Q	R	S	T	U	(# above U) *	S Nail	M Nail
2895	2913	2931	2949	2967	2985	3003	3021	3039	3057	3075	3093	3111	3129	3147	3165	3183	18 (Riser) + 3183 (U)	Std.	N/A

UPHOLSTERY

1087-35

Empire Office Swivel Chair

Standard Pillows: N/A **Finish Req:** N
Standard Cushions: High Resiliency 40 **Standard Finish:** Nickel
COM: 3.5 yards
 Standard with a gas lift and a locking tilt mechanism.

Width: 26.5 **Depth:** 27 **Height:** 42.5
AH: - **SH:** - **SD:** 20 **IW:** 19
Weight: 73 / 86 lbs **Cube:** 21.65

D	E	F	G	H	J	K _{COM}	L	M	N	O	P	Q	R	S	T	U	(# above U) *	S Nail	M Nail
1935	1947	1959	1971	1983	1995	2007	2019	2031	2043	2055	2067	2079	2091	2103	2115	2127	12 (Riser) + 2127 (U)	N/A	N/A

1088-35

Somerset Office Swivel Chair

Standard Pillows: N/A **Finish Req:** Y
Standard Cushions: High Resiliency 40 **Standard Finish:** N/A
COM: 4.5 yards
 Standard with a gas lift.

Width: 28 **Depth:** 31 **Height:** 44
AH: 27 **SH:** 20.5 **SD:** 20.5 **IW:** 19
Weight: 35 / 45 lbs **Cube:** 23.22

D	E	F	G	H	J	K _{COM}	L	M	N	O	P	Q	R	S	T	U	(# above U) *	S Nail	M Nail
2235	2250	2265	2280	2295	2310	2325	2340	2355	2370	2385	2400	2415	2430	2445	2460	2475	15 (Riser) + 2475 (U)	Std.	N/A

1138-01

Tipsy Lounge Chair

Wooden Base

Standard Pillows: N/A **Finish Req:** Y
Standard Cushions: Ultra Plush **Standard Finish:** N/A
COM: 4.75 yards

Width: 28.75 **Depth:** 32 **Height:** 30.25
AH: 25 **SH:** 19 **SD:** 22.5 **IW:** 22
Weight: 72 / 85 lbs **Cube:** 23.89

D	E	F	G	H	J	K _{COM}	L	M	N	O	P	Q	R	S	T	U	(# above U) *	S Nail	M Nail
2100	2115	2130	2145	2160	2175	2190	2205	2220	2235	2250	2265	2280	2295	2310	2325	2340	15 (Riser) + 2340 (U)	60	75

1139-01

Tipsy Lounge Chair

Wooden Base

Standard Pillows: N/A **Finish Req:** Y
Standard Cushions: Ultra Plush **Standard Finish:** N/A
COM: 4.75 yards

Width: 28.75 **Depth:** 31 **Height:** 30.25
AH: 25.5 **SH:** 19 **SD:** 22 **IW:** 21.25
Weight: 59 / 71 lbs **Cube:** 23.89

D	E	F	G	H	J	K _{COM}	L	M	N	O	P	Q	R	S	T	U	(# above U) *	S Nail	M Nail
2325	2340	2355	2370	2385	2400	2415	2430	2445	2460	2475	2490	2505	2520	2535	2550	2565	15 (Riser) + 2565 (U)	60	75

1167-01

Asher Lounge Chair

Standard Pillows: N/A **Finish Req:** Y
Standard Cushions: High Resiliency 40 **Standard Finish:** N/A
COM: 5 yards

Width: 31 **Depth:** 29 **Height:** 27
AH: 27 **SH:** 17.5 **SD:** 25.5 **IW:** 23
Weight: 93 / 106 lbs **Cube:** 29.69

D	E	F	G	H	J	K _{COM}	L	M	N	O	P	Q	R	S	T	U	(# above U) *	S Nail	M Nail
2250	2271	2292	2313	2334	2355	2376	2397	2418	2439	2460	2481	2502	2523	2544	2565	2586	21 (Riser) + 2586 (U)	45	60

1167-31

Asher Swivel Chair

Standard Pillows: N/A **Finish Req:** Y
Standard Cushions: High Resiliency 40 **Standard Finish:** N/A
COM: 5 yards

Width: 31 **Depth:** 29 **Height:** 27
AH: 27 **SH:** 17.5 **SD:** 25.5 **IW:** 23
Weight: 95 / 106 lbs **Cube:** 29.69

D	E	F	G	H	J	K _{COM}	L	M	N	O	P	Q	R	S	T	U	(# above U) *	S Nail	M Nail
2325	2346	2367	2388	2409	2430	2451	2472	2493	2514	2535	2556	2577	2598	2619	2640	2661	21 (Riser) + 2661 (U)	45	60

1401-05

Socrates Barrell Back Dining Chair

with Casters

Standard Pillows: N/A **Finish Req:** N
Standard Cushions: High Resiliency 35 **Standard Finish:** N/A
COM: 4 yards
 Features six concealed casters.

Width: 24 **Depth:** 24 **Height:** 31.5
AH: - **SH:** 19.5 **SD:** 20 **IW:** 20
Weight: 29 / 29 lbs **Cube:** 10.5

D	E	F	G	H	J	K _{COM}	L	M	N	O	P	Q	R	S	T	U	(# above U) *	S Nail	M Nail
1200	1212	1224	1236	1248	1260	1272	1284	1296	1308	1320	1332	1344	1356	1368	1380	1392	12 (Riser) + 1392 (U)	60	N/A

UPHOLSTERY

1402-05

Aristotle Barrell Back Dining Chair

with Casters

Width: 24 Depth: 24 Height: 31.5

AH: - SH: 19.5 SD: 20 IW: 20

Weight: 29 / 29 lbs Cube: 10.5

Standard Pillows: N/A Finish Req: N

Standard Cushions: High Resiliency 35 Standard Finish: N/A

COM: 4 yards

Features six concealed casters.

D	E	F	G	H	J	K _{COM}	L	M	N	O	P	Q	R	S	T	U	(# above U) *	S Nail	M Nail
1200	1212	1224	1236	1248	1260	1272	1284	1296	1308	1320	1332	1344	1356	1368	1380	1392	12 (Riser) + 1392 (U)	60	N/A

1431-01

Chapman Lounge Chair

Width: 30.5 Depth: 32.25 Height: 35.75

AH: 23.25 SH: 19.25 SD: 21.25 IW: 22.5

Weight: 48 / 63 lbs Cube: 23.89

Standard Pillows: N/A Finish Req: Y

Standard Cushions: High Resiliency 30 Standard Finish: N/A

COM: 5 yards

D	E	F	G	H	J	K _{COM}	L	M	N	O	P	Q	R	S	T	U	(# above U) *	S Nail	M Nail
2100	2115	2130	2145	2160	2175	2190	2205	2220	2235	2250	2265	2280	2295	2310	2325	2340	15 (Riser) + 2340 (U)	75	90

1435-01

La Brea Occasional Chair

Width: 27 Depth: 33.75 Height: 33.5

AH: 24 SH: 20.5 SD: 20 IW: 23.5

Weight: 34 / 34 lbs Cube: 17.66

Standard Pillows: N/A Finish Req: Y

Standard Cushions: Classic Plush Standard Finish: N/A

COM: 4.5 yards

D	E	F	G	H	J	K _{COM}	L	M	N	O	P	Q	R	S	T	U	(# above U) *	S Nail	M Nail
2085	2100	2115	2130	2145	2160	2175	2190	2205	2220	2235	2250	2265	2280	2295	2310	2325	15 (Riser) + 2325 (U)	120	N/A

1601-10

Snyder Bench

Width: 51 Depth: 22 Height: 32

AH: 27 SH: 19.5 SD: 19 IW: 46

Weight: 45 / 55 lbs Cube: 21.33

Standard Pillows: N/A Finish Req: Y

Standard Cushions: High Resiliency 40 Standard Finish: N/A

COM: 3.75 yards

D	E	F	G	H	J	K _{COM}	L	M	N	O	P	Q	R	S	T	U	(# above U) *	S Nail	M Nail
2100	2112	2124	2136	2148	2160	2172	2184	2196	2208	2220	2232	2244	2256	2268	2280	2292	12 (Riser) + 2292 (U)	N/A	N/A

1603-10

Luna Bench

Width: 56 Depth: 22 Height: 26.5

AH: 26.5 SH: 19.5 SD: 22 IW: 48

Weight: 55 / 75 lbs Cube: 23.16

Standard Pillows: N/A Finish Req: Y

Standard Cushions: High Resiliency 40 Standard Finish: N/A

COM: 4 yards

D	E	F	G	H	J	K _{COM}	L	M	N	O	P	Q	R	S	T	U	(# above U) *	S Nail	M Nail
1845	1857	1869	1881	1893	1905	1917	1929	1941	1953	1965	1977	1989	2001	2013	2025	2037	12 (Riser) + 2037 (U)	60	75

1604-20

Kerbey Square Cocktail Ottoman

Width: 38.5 Depth: 38.5 Height: 16

AH: - SH: 16 SD: - IW: -

Weight: 37 / 37 lbs Cube: 13.72

Standard Pillows: N/A Finish Req: N

Standard Cushions: High Resiliency 40 Standard Finish: N/A

COM: 4.25 yards

D	E	F	G	H	J	K _{COM}	L	M	N	O	P	Q	R	S	T	U	(# above U) *	S Nail	M Nail
1050	1062	1074	1086	1098	1110	1122	1134	1146	1158	1170	1182	1194	1206	1218	1230	1242	12 (Riser) + 1242 (U)	N/A	N/A

1605-20

Kilby Round Cocktail Ottoman

Width: 38.5 Depth: 38.5 Height: 15.25

AH: - SH: 15.25 SD: - IW: -

Weight: 37 / 37 lbs Cube: 13.08

Standard Pillows: N/A Finish Req: N

Standard Cushions: High Resiliency 40 Standard Finish: N/A

COM: 4.25 yards

D	E	F	G	H	J	K _{COM}	L	M	N	O	P	Q	R	S	T	U	(# above U) *	S Nail	M Nail
1050	1062	1074	1086	1098	1110	1122	1134	1146	1158	1170	1182	1194	1206	1218	1230	1242	12 (Riser) + 1242 (U)	N/A	N/A

UPHOLSTERY

1606-20

Standard Pillows: N/A **Finish Req:** N
Standard Cushions: High Resiliency 40 **Standard Finish:** N/A
COM: 4.5 yards

Shiloh Round Cocktail Ottoman

Width: 44.5 **Depth:** 44.5 **Height:** 15.25

AH: - **SH:** 15.25 **SD:** - **IW:** -

Weight: 45 / 45 lbs **Cube:** 17.47

D	E	F	G	H	J	K _{COM}	L	M	N	O	P	Q	R	S	T	U	(# above U) *	S Nail	M Nail
1125	1140	1155	1170	1185	1200	1215	1230	1245	1260	1275	1290	1305	1320	1335	1350	1365	15 (Riser) + 1365 (U)	N/A	N/A

1611-10

Standard Pillows: N/A **Finish Req:** Y
Standard Cushions: High Resiliency 30 **Standard Finish:** N/A
COM: 3.75 yards

Benson Bench

Width: 53.5 **Depth:** 18.5 **Height:** 26.5

AH: 26.5 **SH:** 19.5 **SD:** 18.5 **IW:** 41

Weight: 60 / 65 lbs **Cube:** 25.6

D	E	F	G	H	J	K _{COM}	L	M	N	O	P	Q	R	S	T	U	(# above U) *	S Nail	M Nail
1665	1680	1695	1710	1725	1740	1755	1770	1785	1800	1815	1830	1845	1860	1875	1890	1905	15 (Riser) + 1905 (U)	45	60

1615-20

Standard Pillows: N/A **Finish Req:** Y
Standard Cushions: High Resiliency 20 **Standard Finish:** N/A
COM: 3.75 yards

Roswell Cocktail Ottoman

Width: 33 **Depth:** 33 **Height:** 19.5

AH: - **SH:** - **SD:** - **IW:** -

Weight: 45 / 50 lbs **Cube:** 16.92

D	E	F	G	H	J	K _{COM}	L	M	N	O	P	Q	R	S	T	U	(# above U) *	S Nail	M Nail
1485	1500	1515	1530	1545	1560	1575	1590	1605	1620	1635	1650	1665	1680	1695	1710	1725	15 (Riser) + 1725 (U)	30	45

1618-20

Standard Pillows: N/A **Finish Req:** Y
Standard Cushions: High Resiliency 40 **Standard Finish:** N/A
COM: 2 yards

Stonewood Oval Cocktail Ottoman

Width: 38 **Depth:** 25.5 **Height:** 20

AH: - **SH:** - **SD:** - **IW:** -

Weight: 45 / 55 lbs **Cube:** 20.21

D	E	F	G	H	J	K _{COM}	L	M	N	O	P	Q	R	S	T	U	(# above U) *	S Nail	M Nail
1500	1506	1512	1518	1524	1530	1536	1542	1548	1554	1560	1566	1572	1578	1584	1590	1596	6 (Riser) + 1596 (U)	N/A	N/A

1619-20

Standard Pillows: N/A **Finish Req:** Y
Standard Cushions: High Resiliency 40 **Standard Finish:** N/A
COM: 2.5 yards

Cannon Cocktail Ottoman

Width: 18.5 **Depth:** 18.5 **Height:** 19.5

AH: - **SH:** - **SD:** - **IW:** -

Weight: 25 / 30 lbs **Cube:** 10.77

D	E	F	G	H	J	K _{COM}	L	M	N	O	P	Q	R	S	T	U	(# above U) *	S Nail	M Nail
1215	1224	1233	1242	1251	1260	1269	1278	1287	1296	1305	1314	1323	1332	1341	1350	1359	9 (Riser) + 1359 (U)	30	N/A

1652-20

Standard Pillows: N/A **Finish Req:** Y
Standard Cushions: High Resiliency 30 **Standard Finish:** traditional
COM: 2.5 yards

Irving Bunching Ottoman

Width: 19 **Depth:** 19 **Height:** 20

AH: - **SH:** - **SD:** - **IW:** -

Weight: 30 / 35 lbs **Cube:** 10.77

D	E	F	G	H	J	K _{COM}	L	M	N	O	P	Q	R	S	T	U	(# above U) *	S Nail	M Nail
750	759	768	777	786	795	804	813	822	831	840	849	858	867	876	885	894	9 (Riser) + 894 (U)	30	45

1672-22

Standard Pillows: N/A **Finish Req:** N
Standard Cushions: High Resiliency 30 **Standard Finish:** traditional
COM: 2.75 yards
 Features a Lift-off Lid

Kaplan Storage Ottoman

Width: 19 **Depth:** 19 **Height:** 21

AH: - **SH:** - **SD:** - **IW:** -

Weight: 30 / 35 lbs **Cube:** 10.77

D	E	F	G	H	J	K _{COM}	L	M	N	O	P	Q	R	S	T	U	(# above U) *	S Nail	M Nail
960	972	984	996	1008	1020	1032	1044	1056	1068	1080	1092	1104	1116	1128	1140	1152	12 (Riser) + 1152 (U)	30	45

UPHOLSTERY

1676-20

Standard Pillows: N/A Finish Req: Y
 Standard Cushions: High Resiliency 30 Standard Finish: N/A
 COM: 3.75 yards

Jenkins Cocktail Ottoman

Width: 36.5 Depth: 36.5 Height: 19
 AH: - SH: - SD: - IW: -
 Weight: 40 / 50 lbs Cube: 16.92

D	E	F	G	H	J	K _{COM}	L	M	N	O	P	Q	R	S	T	U	(# above U) *	S Nail	M Nail
1485	1497	1509	1521	1533	1545	1557	1569	1581	1593	1605	1617	1629	1641	1653	1665	1677	12 (Riser) + 1677 (U)	60	75

1677-20

Standard Pillows: N/A Finish Req: Y
 Standard Cushions: High Resiliency 35 Standard Finish: N/A
 COM: 3.25 yards

Joplin Cocktail Ottoman

Width: 36.5 Depth: 36.5 Height: 20
 AH: - SH: - SD: - IW: -
 Weight: 30 / 35 lbs Cube: 16.92

D	E	F	G	H	J	K _{COM}	L	M	N	O	P	Q	R	S	T	U	(# above U) *	S Nail	M Nail
1320	1329	1338	1347	1356	1365	1374	1383	1392	1401	1410	1419	1428	1437	1446	1455	1464	9 (Riser) + 1464 (U)	45	60

1685-10

Standard Pillows: N/A Finish Req: Y
 Standard Cushions: Endurance Standard Finish: N/A
 COM: 6.25 yards

Beacon Bench

Width: 55 Depth: 23 Height: 25
 AH: 25 SH: 22 SD: 18.5 IW: 46
 Weight: 60 / 80 lbs Cube: 26.76

D	E	F	G	H	J	K _{COM}	L	M	N	O	P	Q	R	S	T	U	(# above U) *	S Nail	M Nail
2355	2373	2391	2409	2427	2445	2463	2481	2499	2517	2535	2553	2571	2589	2607	2625	2643	18 (Riser) + 2643 (U)	60	75

1693-10

Standard Pillows: N/A Finish Req: Y
 Standard Cushions: High Resiliency 40 Standard Finish: N/A
 COM: 2 yards

Deerfield Bench

Width: 45.5 Depth: 18 Height: 20.5
 AH: - SH: - SD: - IW: -
 Weight: 55 / 45 lbs Cube: 15.26

D	E	F	G	H	J	K _{COM}	L	M	N	O	P	Q	R	S	T	U	(# above U) *	S Nail	M Nail
1155	1161	1167	1173	1179	1185	1191	1197	1203	1209	1215	1221	1227	1233	1239	1245	1251	6 (Riser) + 1251 (U)	45	60

1695-20

Standard Pillows: N/A Finish Req: Y
 Standard Cushions: High Resiliency 30 Standard Finish: N/A
 COM: 3.75 yards

Erwin Cocktail Ottoman

Width: 33 Depth: 33 Height: 22.5
 AH: - SH: - SD: - IW: -
 Weight: 45 / 50 lbs Cube: 16.92

D	E	F	G	H	J	K _{COM}	L	M	N	O	P	Q	R	S	T	U	(# above U) *	S Nail	M Nail
1425	1437	1449	1461	1473	1485	1497	1509	1521	1533	1545	1557	1569	1581	1593	1605	1617	12 (Riser) + 1617 (U)	45	60

1700-10

Standard Pillows: N/A Finish Req: Y
 Standard Cushions: High Resiliency 40 Standard Finish: N/A
 COM: 4.75 yards

Maeve Bench

Width: 54.5 Depth: 20.5 Height: 26.5
 AH: 26.5 SH: 19.5 SD: 17 IW: 48
 Weight: 49 / 49 lbs Cube: 17.13

D	E	F	G	H	J	K _{COM}	L	M	N	O	P	Q	R	S	T	U	(# above U) *	S Nail	M Nail
1875	1890	1905	1920	1935	1950	1965	1980	1995	2010	2025	2040	2055	2070	2085	2100	2115	15 (Riser) + 2115 (U)	75	N/A

1704-10

Standard Pillows: N/A Finish Req: Y
 Standard Cushions: High Resiliency 40 Standard Finish: N/A
 COM: 2.75 yards

Garfield Bench

Width: 47.5 Depth: 19 Height: 27.5
 AH: 27.5 SH: 20 SD: 19 IW: 36
 Weight: 40 / 54 lbs Cube: 15.26

D	E	F	G	H	J	K _{COM}	L	M	N	O	P	Q	R	S	T	U	(# above U) *	S Nail	M Nail
1485	1494	1503	1512	1521	1530	1539	1548	1557	1566	1575	1584	1593	1602	1611	1620	1629	9 (Riser) + 1629 (U)	45	60

UPHOLSTERY

1715-20

Standard Pillows: N/A Finish Req: Y
 Standard Cushions: High Resiliency 55 Standard Finish: N/A
 COM: 3.75 yards

Elizabella Cocktail Ottoman

Width: 37.5 Depth: 37.5 Height: 18.5
 AH: - SH: 18.5 SD: 31 IW: 31
 Weight: 50 / 50 lbs Cube: 15.05

D	E	F	G	H	J	K _{COM}	L	M	N	O	P	Q	R	S	T	U	(# above U) *	S Nail	M Nail
1500	1512	1524	1536	1548	1560	1572	1584	1596	1608	1620	1632	1644	1656	1668	1680	1692	12 (Riser) + 1692 (U)	N/A	N/A

1724-10

Standard Pillows: N/A Finish Req: Y
 Standard Cushions: High Resiliency 40 Standard Finish: N/A
 COM: 3.5 yards

Hampton Bench

Width: 60 Depth: 19 Height: 28.5
 AH: 28.5 SH: 22 SD: 19 IW: 48.5
 Weight: 50 / 60 lbs Cube: 25.6

D	E	F	G	H	J	K _{COM}	L	M	N	O	P	Q	R	S	T	U	(# above U) *	S Nail	M Nail
1680	1689	1698	1707	1716	1725	1734	1743	1752	1761	1770	1779	1788	1797	1806	1815	1824	9 (Riser) + 1824 (U)	45	60

1742-10

Standard Pillows: N/A Finish Req: Y
 Standard Cushions: High Resiliency 40 Standard Finish: N/A
 COM: 4.25 yards

Evie Bench

Width: 58 Depth: 23.5 Height: 26.5
 AH: 26.5 SH: 19 SD: 18 IW: 46.5
 Weight: 59 / 79 lbs Cube: 23.16

D	E	F	G	H	J	K _{COM}	L	M	N	O	P	Q	R	S	T	U	(# above U) *	S Nail	M Nail
1950	1962	1974	1986	1998	2010	2022	2034	2046	2058	2070	2082	2094	2106	2118	2130	2142	12 (Riser) + 2142 (U)	75	90

1750-10

Standard Pillows: N/A Finish Req: Y
 Standard Cushions: High Resiliency 40 Standard Finish: N/A
 COM: 2.5 yards

Inman Bench

Width: 58.5 Depth: 19 Height: 26
 AH: 25.5 SH: 19 SD: 19 IW: 44.5
 Weight: 40 / 50 lbs Cube: 25.6

D	E	F	G	H	J	K _{COM}	L	M	N	O	P	Q	R	S	T	U	(# above U) *	S Nail	M Nail
1590	1599	1608	1617	1626	1635	1644	1653	1662	1671	1680	1689	1698	1707	1716	1725	1734	9 (Riser) + 1734 (U)	45	N/A

1751-10

Standard Pillows: N/A Finish Req: Y
 Standard Cushions: High Resiliency 40 Standard Finish: N/A
 COM: 4 yards

Jena Bench

Width: 58 Depth: 22 Height: 27
 AH: 27 SH: 18.5 SD: 17.5 IW: 48
 Weight: 40 / 50 lbs Cube: 25.6

D	E	F	G	H	J	K _{COM}	L	M	N	O	P	Q	R	S	T	U	(# above U) *	S Nail	M Nail
1890	1902	1914	1926	1938	1950	1962	1974	1986	1998	2010	2022	2034	2046	2058	2070	2082	12 (Riser) + 2082 (U)	45	N/A

1765-10

Standard Pillows: N/A Finish Req: Y
 Standard Cushions: High Resiliency 40 Standard Finish: N/A
 COM: 3.25 yards

Kenner Bench

Width: 55 Depth: 19 Height: 27
 AH: 27 SH: 19 SD: 19 IW: 44
 Weight: 40 / 50 lbs Cube: 25.6

D	E	F	G	H	J	K _{COM}	L	M	N	O	P	Q	R	S	T	U	(# above U) *	S Nail	M Nail
1470	1479	1488	1497	1506	1515	1524	1533	1542	1551	1560	1569	1578	1587	1596	1605	1614	9 (Riser) + 1614 (U)	45	60

1766-10

Standard Pillows: N/A Finish Req: Y
 Standard Cushions: High Resiliency 40 Standard Finish: N/A
 COM: 4 yards

Lacey Bench

Width: 55 Depth: 21 Height: 26.5
 AH: 26 SH: 19.5 SD: 18 IW: 43.5
 Weight: 65 / 75 lbs Cube: 23.16

D	E	F	G	H	J	K _{COM}	L	M	N	O	P	Q	R	S	T	U	(# above U) *	S Nail	M Nail
1725	1737	1749	1761	1773	1785	1797	1809	1821	1833	1845	1857	1869	1881	1893	1905	1917	12 (Riser) + 1917 (U)	45	60

UPHOLSTERY

1770-10

Standard Pillows: N/A **Finish Req:** Y
Standard Cushions: High Resiliency 40 **Standard Finish:** N/A
COM: 2.25 yards

Malone Bench

Width: 51 **Depth:** 19 **Height:** 20.5
AH: - **SH:** - **SD:** - **IW:** -
Weight: 35 / 40 lbs **Cube:** 21.76

D	E	F	G	H	J	K _{COM}	L	M	N	O	P	Q	R	S	T	U	(# above U) *	S Nail	M Nail
1275	1284	1293	1302	1311	1320	1329	1338	1347	1356	1365	1374	1383	1392	1401	1410	1419	9 (Riser) + 1419 (U)	45	N/A

1777-10

Standard Pillows: N/A **Finish Req:** Y
Standard Cushions: High Resiliency 40 **Standard Finish:** N/A
COM: 3.5 yards

Lorain Bench

Width: 52.5 **Depth:** 21.5 **Height:** 19.5
AH: - **SH:** - **SD:** - **IW:** -
Weight: 46 / 66 lbs **Cube:** 23.16

D	E	F	G	H	J	K _{COM}	L	M	N	O	P	Q	R	S	T	U	(# above U) *	S Nail	M Nail
1485	1494	1503	1512	1521	1530	1539	1548	1557	1566	1575	1584	1593	1602	1611	1620	1629	9 (Riser) + 1629 (U)	60	75

1786-10

Standard Pillows: N/A **Finish Req:** Y
Standard Cushions: High Resiliency 40 **Standard Finish:** N/A
COM: 4.75 yards

Lara Bench

Width: 54 **Depth:** 23 **Height:** 25.5
AH: 25 **SH:** 19 **SD:** 17.5 **IW:** 46
Weight: 55 / 65 lbs **Cube:** 23.16

D	E	F	G	H	J	K _{COM}	L	M	N	O	P	Q	R	S	T	U	(# above U) *	S Nail	M Nail
1830	1845	1860	1875	1890	1905	1920	1935	1950	1965	1980	1995	2010	2025	2040	2055	2070	15 (Riser) + 2070 (U)	60	75

1787-10

Standard Pillows: N/A **Finish Req:** Y
Standard Cushions: High Resiliency 40 **Standard Finish:** N/A
COM: 4.25 yards

Bradshaw Bench

Width: 54.5 **Depth:** 23.5 **Height:** 25
AH: 25 **SH:** 19 **SD:** 23.5 **IW:** 46
Weight: 47 / 67 lbs **Cube:** 23.16

D	E	F	G	H	J	K _{COM}	L	M	N	O	P	Q	R	S	T	U	(# above U) *	S Nail	M Nail
1680	1692	1704	1716	1728	1740	1752	1764	1776	1788	1800	1812	1824	1836	1848	1860	1872	12 (Riser) + 1872 (U)	60	75

2000-C7

Standard Pillows: N/A **Finish Req:** Y
Standard Cushions: High Resiliency 40 **Standard Finish:** N/A
COM: 2.75 yards
 Features a Memory Swivel Seat and Sinuous Seating. Standard with two inch channel quilt on outside back.

Robroy Counter Stool

Width: 24.5 **Depth:** 24.5 **Height:** 42.5
AH: 29 **SH:** 26 **SD:** 19 **IW:** 19
Weight: 35 / 46 lbs **Cube:** 19.6

D	E	F	G	H	J	K _{COM}	L	M	N	O	P	Q	R	S	T	U	(# above U) *	S Nail	M Nail
1725	1734	1743	1752	1761	1770	1779	1788	1797	1806	1815	1824	1833	1842	1851	1860	1869	9 (Riser) + 1869 (U)	45	N/A

2000-07

Standard Pillows: N/A **Finish Req:** Y
Standard Cushions: High Resiliency 40 **Standard Finish:** N/A
COM: 2.75 yards
 Features a Memory Swivel Seat and Sinuous Seating. Standard with two inch channel quilt on outside back.

Robroy Bar Stool

Width: 24.5 **Depth:** 24.5 **Height:** 46.5
AH: 33 **SH:** 30 **SD:** 19 **IW:** 19
Weight: 36 / 49 lbs **Cube:** 19.6

D	E	F	G	H	J	K _{COM}	L	M	N	O	P	Q	R	S	T	U	(# above U) *	S Nail	M Nail
1725	1734	1743	1752	1761	1770	1779	1788	1797	1806	1815	1824	1833	1842	1851	1860	1869	9 (Riser) + 1869 (U)	45	N/A

2001-C7

Standard Pillows: N/A **Finish Req:** Y
Standard Cushions: High Resiliency 40 **Standard Finish:** N/A
COM: 2.75 yards
 Features a Memory Swivel Seat and Sinuous Seating

Robroy Counter Stool

Width: 24.5 **Depth:** 24.5 **Height:** 42.5
AH: 29 **SH:** 26 **SD:** 19 **IW:** 19
Weight: 35 / 46 lbs **Cube:** 19.6

D	E	F	G	H	J	K _{COM}	L	M	N	O	P	Q	R	S	T	U	(# above U) *	S Nail	M Nail
1695	1704	1713	1722	1731	1740	1749	1758	1767	1776	1785	1794	1803	1812	1821	1830	1839	9 (Riser) + 1839 (U)	45	N/A

UPHOLSTERY

2001-07

Robroy Bar Stool

Standard Pillows: N/A **Finish Req:** Y
Standard Cushions: High Resiliency 40 **Standard Finish:** N/A
COM: 2.75 yards
 Features a Memory Swivel Seat and Sinuous Seating

Width: 24.5 **Depth:** 24.5 **Height:** 46.5
AH: 33 **SH:** 30 **SD:** 19 **IW:** 19
Weight: 36 / 49 lbs **Cube:** 19.6

D	E	F	G	H	J	K _{COM}	L	M	N	O	P	Q	R	S	T	U	(# above U) *	S Nail	M Nail
1695	1704	1713	1722	1731	1740	1749	1758	1767	1776	1785	1794	1803	1812	1821	1830	1839	9 (Riser) + 1839 (U)	45	N/A

2002-C7

Vesper Counter Stool

Standard Pillows: N/A **Finish Req:** Y
Standard Cushions: High Resiliency 40 **Standard Finish:** N/A
COM: 2.75 yards
 Features a Memory Swivel Seat and Sinuous Seating

Width: 24 **Depth:** 26 **Height:** 40
AH: - **SH:** 26 **SD:** 20 **IW:** 20.5
Weight: 35 / 46 lbs **Cube:** 19.6

D	E	F	G	H	J	K _{COM}	L	M	N	O	P	Q	R	S	T	U	(# above U) *	S Nail	M Nail
1650	1659	1668	1677	1686	1695	1704	1713	1722	1731	1740	1749	1758	1767	1776	1785	1794	9 (Riser) + 1794 (U)	45	N/A

2002-M7

Vesper Billiard Bar Stool

Standard Pillows: N/A **Finish Req:** N
Standard Cushions: High Resiliency 40 **Standard Finish:** Nickel
COM: 2.75 yards
 360 Swivel. Adjustable height.

Width: 24 **Depth:** 26 **Height:** 44
AH: - **SH:** 30 **SD:** 20 **IW:** 20.5
Weight: 35 / 46 lbs **Cube:** 24.14

D	E	F	G	H	J	K _{COM}	L	M	N	O	P	Q	R	S	T	U	(# above U) *	S Nail	M Nail
2325	2334	2343	2352	2361	2370	2379	2388	2397	2406	2415	2424	2433	2442	2451	2460	2469	9 (Riser) + 2469 (U)	45	N/A

2002-07

Vesper Bar Stool

Standard Pillows: N/A **Finish Req:** Y
Standard Cushions: High Resiliency 40 **Standard Finish:** N/A
COM: 2.75 yards
 Features a Memory Swivel Seat

Width: 24 **Depth:** 26 **Height:** 44
AH: - **SH:** 30 **SD:** 20 **IW:** 20.5
Weight: 35 / 48 lbs **Cube:** 19.6

D	E	F	G	H	J	K _{COM}	L	M	N	O	P	Q	R	S	T	U	(# above U) *	S Nail	M Nail
1650	1659	1668	1677	1686	1695	1704	1713	1722	1731	1740	1749	1758	1767	1776	1785	1794	9 (Riser) + 1794 (U)	45	N/A

2003-C6

Sidecar Counter Stool

Standard Pillows: N/A **Finish Req:** Y
Standard Cushions: High Resiliency 40 **Standard Finish:** N/A
COM: 3.25 yards
 Features a Memory Swivel Seat

Width: 21.5 **Depth:** 22.75 **Height:** 40.25
AH: 32 **SH:** 26 **SD:** 19.25 **IW:** 16.5
Weight: 32 / 43 lbs **Cube:** 15.74

D	E	F	G	H	J	K _{COM}	L	M	N	O	P	Q	R	S	T	U	(# above U) *	S Nail	M Nail
1845	1854	1863	1872	1881	1890	1899	1908	1917	1926	1935	1944	1953	1962	1971	1980	1989	9 (Riser) + 1989 (U)	45	N/A

2003-06

Sidecar Bar Stool

Standard Pillows: N/A **Finish Req:** Y
Standard Cushions: High Resiliency 40 **Standard Finish:** N/A
COM: 3.25 yards
 Features a Memory Swivel Seat

Width: 21.5 **Depth:** 22.75 **Height:** 44.25
AH: 36 **SH:** 30 **SD:** 19.25 **IW:** 16.5
Weight: 33 / 46 lbs **Cube:** 19.6

D	E	F	G	H	J	K _{COM}	L	M	N	O	P	Q	R	S	T	U	(# above U) *	S Nail	M Nail
1845	1854	1863	1872	1881	1890	1899	1908	1917	1926	1935	1944	1953	1962	1971	1980	1989	9 (Riser) + 1989 (U)	45	N/A

2004-C6

Gimlet Counter Stool

Standard Pillows: N/A **Finish Req:** Y
Standard Cushions: High Resiliency 40 **Standard Finish:** N/A
COM: 2.25 yards
 Features a Memory Swivel Seat

Width: 22.5 **Depth:** 24.5 **Height:** 37.25
AH: 32 **SH:** 26 **SD:** 19.75 **IW:** 20.25
Weight: 34 / 44 lbs **Cube:** 15.74

D	E	F	G	H	J	K _{COM}	L	M	N	O	P	Q	R	S	T	U	(# above U) *	S Nail	M Nail
1725	1734	1743	1752	1761	1770	1779	1788	1797	1806	1815	1824	1833	1842	1851	1860	1869	9 (Riser) + 1869 (U)	45	N/A

UPHOLSTERY

2004-06

Gimlet Bar Stool

Standard Pillows: N/A **Finish Req:** Y
Standard Cushions: High Resiliency 40 **Standard Finish:** N/A
COM: 2.25 yards
 Features a Memory Swivel Seat

Width: 22.5 **Depth:** 24.5 **Height:** 41.25
AH: 36 **SH:** 30 **SD:** 19.75 **IW:** 20.25
Weight: 34 / 45 lbs **Cube:** 19.6

D	E	F	G	H	J	K _{COM}	L	M	N	O	P	Q	R	S	T	U	(# above U) *	S Nail	M Nail
1725	1734	1743	1752	1761	1770	1779	1788	1797	1806	1815	1824	1833	1842	1851	1860	1869	9 (Riser) + 1869 (U)	45	N/A

2005-C7

Cosmo Counter Stool

Standard Pillows: N/A **Finish Req:** Y
Standard Cushions: High Resiliency 40 **Standard Finish:** N/A
COM: 2.25 yards
 Features a Memory Swivel Seat

Width: 22 **Depth:** 22 **Height:** 32.75
AH: 32.75 **SH:** 26 **SD:** 18.75 **IW:** 17
Weight: 35 / 45 lbs **Cube:** 15.74

D	E	F	G	H	J	K _{COM}	L	M	N	O	P	Q	R	S	T	U	(# above U) *	S Nail	M Nail
1620	1629	1638	1647	1656	1665	1674	1683	1692	1701	1710	1719	1728	1737	1746	1755	1764	9 (Riser) + 1764 (U)	45	N/A

2005-07

Cosmo Bar Stool

Standard Pillows: N/A **Finish Req:** Y
Standard Cushions: High Resiliency 40 **Standard Finish:** N/A
COM: 2.25 yards
 Features a Memory Swivel Seat

Width: 22 **Depth:** 22 **Height:** 36.75
AH: 36.75 **SH:** 30 **SD:** 18.75 **IW:** 17.5
Weight: 35 / 45 lbs **Cube:** 15.74

D	E	F	G	H	J	K _{COM}	L	M	N	O	P	Q	R	S	T	U	(# above U) *	S Nail	M Nail
1620	1629	1638	1647	1656	1665	1674	1683	1692	1701	1710	1719	1728	1737	1746	1755	1764	9 (Riser) + 1764 (U)	45	N/A

2008-C6

Spritzer Counter Stool

Standard Pillows: N/A **Finish Req:** Y
Standard Cushions: High Resiliency 40 **Standard Finish:** N/A
COM: 2.5 yards
 Features a Memory Swivel Seat

Width: 25.75 **Depth:** 27.75 **Height:** 43
AH: 31 **SH:** 26 **SD:** 21.5 **IW:** 22.75
Weight: 39 / 44 lbs **Cube:** 24.14

D	E	F	G	H	J	K _{COM}	L	M	N	O	P	Q	R	S	T	U	(# above U) *	S Nail	M Nail
1845	1854	1863	1872	1881	1890	1899	1908	1917	1926	1935	1944	1953	1962	1971	1980	1989	9 (Riser) + 1989 (U)	90	N/A

2008-06

Spritzer Bar Stool

Standard Pillows: N/A **Finish Req:** Y
Standard Cushions: High Resiliency 40 **Standard Finish:** N/A
COM: 2.5 yards
 Features a Memory Swivel Seat

Width: 25.75 **Depth:** 27.75 **Height:** 47
AH: 35 **SH:** 30 **SD:** 21.5 **IW:** 22.75
Weight: 39 / 54 lbs **Cube:** 24.14

D	E	F	G	H	J	K _{COM}	L	M	N	O	P	Q	R	S	T	U	(# above U) *	S Nail	M Nail
1845	1854	1863	1872	1881	1890	1899	1908	1917	1926	1935	1944	1953	1962	1971	1980	1989	9 (Riser) + 1989 (U)	90	N/A

2009-C7

Juliet Counter Stool

Standard Pillows: N/A **Finish Req:** Y
Standard Cushions: High Resiliency 40 **Standard Finish:** N/A
COM: 2 yards

Width: 21 **Depth:** 22 **Height:** 36.5
AH: - **SH:** 25.5 **SD:** 19 **IW:** -
Weight: 25 / 35 lbs **Cube:** 15.74

D	E	F	G	H	J	K _{COM}	L	M	N	O	P	Q	R	S	T	U	(# above U) *	S Nail	M Nail
1425	1431	1437	1443	1449	1455	1461	1467	1473	1479	1485	1491	1497	1503	1509	1515	1521	6 (Riser) + 1521 (U)	N/A	N/A

2009-07

Juliet Bar Stool

Standard Pillows: N/A **Finish Req:** Y
Standard Cushions: High Resiliency 40 **Standard Finish:** N/A
COM: 2 yards

Width: 21 **Depth:** 22 **Height:** 40.5
AH: - **SH:** 29.5 **SD:** 19 **IW:** -
Weight: 25 / 37 lbs **Cube:** 17.77

D	E	F	G	H	J	K _{COM}	L	M	N	O	P	Q	R	S	T	U	(# above U) *	S Nail	M Nail
1425	1431	1437	1443	1449	1455	1461	1467	1473	1479	1485	1491	1497	1503	1509	1515	1521	6 (Riser) + 1521 (U)	N/A	N/A

UPHOLSTERY

2010-C7

Bellini Counter Stool

Standard Pillows: N/A **Finish Req:** Y
Standard Cushions: High Resiliency 40 **Standard Finish:** N/A
COM: 2.5 yards
 Memory Swivel Standard.

Width: 22.5 **Depth:** 26 **Height:** 41
AH: - **SH:** 26 **SD:** 19 **IW:** 185
Weight: 38 / 38 lbs **Cube:** 13.88

D	E	F	G	H	J	K _{COM}	L	M	N	O	P	Q	R	S	T	U	(# above U) *	S Nail	M Nail
1575	1584	1593	1602	1611	1620	1629	1638	1647	1656	1665	1674	1683	1692	1701	1710	1719	9 (Riser) + 1719 (U)	75	N/A

2010-07

Bellini Bar Stool

Standard Pillows: N/A **Finish Req:** Y
Standard Cushions: High Resiliency 40 **Standard Finish:** N/A
COM: 2.5 yards
 Memory Swivel Standard.

Width: 22.5 **Depth:** 26 **Height:** 45
AH: - **SH:** 30 **SD:** 19 **IW:** 18.5
Weight: 38 / 38 lbs **Cube:** 15.23

D	E	F	G	H	J	K _{COM}	L	M	N	O	P	Q	R	S	T	U	(# above U) *	S Nail	M Nail
1575	1584	1593	1602	1611	1620	1629	1638	1647	1656	1665	1674	1683	1692	1701	1710	1719	9 (Riser) + 1719 (U)	75	N/A

2011-C7

Magnolia Counter Stool

Standard Pillows: N/A **Finish Req:** Y
Standard Cushions: High Resiliency 30 **Standard Finish:** N/A
COM: 2 yards

Width: 18.5 **Depth:** 23.5 **Height:** 37.75
AH: - **SH:** 26 **SD:** 17 **IW:** 18.5
Weight: 29 / 29 lbs **Cube:** 15.74

D	E	F	G	H	J	K _{COM}	L	M	N	O	P	Q	R	S	T	U	(# above U) *	S Nail	M Nail
1200	1206	1212	1218	1224	1230	1236	1242	1248	1254	1260	1266	1272	1278	1284	1290	1296	6 (Riser) + 1296 (U)	45	N/A

2011-05

Magnolia Side Chair

Standard Pillows: N/A **Finish Req:** Y
Standard Cushions: High Resiliency 30 **Standard Finish:** N/A
COM: 2 yards

Width: 21.75 **Depth:** 21 **Height:** 34
AH: - **SH:** 19 **SD:** 19 **IW:** 21.75
Weight: 16 / 16 lbs **Cube:** 8.98

D	E	F	G	H	J	K _{COM}	L	M	N	O	P	Q	R	S	T	U	(# above U) *	S Nail	M Nail
1170	1176	1182	1188	1194	1200	1206	1212	1218	1224	1230	1236	1242	1248	1254	1260	1266	6 (Riser) + 1266 (U)	45	N/A

2011-07

Magnolia Bar Stool

Standard Pillows: N/A **Finish Req:** Y
Standard Cushions: High Resiliency 30 **Standard Finish:** N/A
COM: 2 yards

Width: 18.5 **Depth:** 23.5 **Height:** 41.75
AH: - **SH:** 30 **SD:** 17 **IW:** 18.5
Weight: 30 / 30 lbs **Cube:** 17.77

D	E	F	G	H	J	K _{COM}	L	M	N	O	P	Q	R	S	T	U	(# above U) *	S Nail	M Nail
1200	1206	1212	1218	1224	1230	1236	1242	1248	1254	1260	1266	1272	1278	1284	1290	1296	6 (Riser) + 1296 (U)	45	N/A

2012-C6

Allie Counter Stool

Standard Pillows: N/A **Finish Req:** Y
Standard Cushions: High Resiliency 30 **Standard Finish:** N/A
COM: 2.75 yards

Width: 24.5 **Depth:** 21.25 **Height:** 35
AH: 35 **SH:** 27 **SD:** 19.5 **IW:** 18.5
Weight: 42 / 42 lbs **Cube:** 10.54

D	E	F	G	H	J	K _{COM}	L	M	N	O	P	Q	R	S	T	U	(# above U) *	S Nail	M Nail
1980	1989	1998	2007	2016	2025	2034	2043	2052	2061	2070	2079	2088	2097	2106	2115	2124	9 (Riser) + 2124 (U)	N/A	N/A

2012-06

Allie Bar Stool

Standard Pillows: N/A **Finish Req:** Y
Standard Cushions: High Resiliency 30 **Standard Finish:** N/A
COM: 2.75 yards

Width: 24.5 **Depth:** 21.25 **Height:** 39
AH: 39 **SH:** 31 **SD:** 19.5 **IW:** 18.5
Weight: 43 / 42 lbs **Cube:** 15.74

D	E	F	G	H	J	K _{COM}	L	M	N	O	P	Q	R	S	T	U	(# above U) *	S Nail	M Nail
1980	1989	1998	2007	2016	2025	2034	2043	2052	2061	2070	2079	2088	2097	2106	2115	2124	9 (Riser) + 2124 (U)	N/A	N/A

UPHOLSTERY

2014-C7

Riley Counter Stool

Width: 22 Depth: 25.5 Height: 41.25
 AH: - SH: 27.5 SD: 18.5 IW: 20.5
 Weight: 30 / 43 lbs Cube: 13.39

Standard Pillows: N/A Finish Req: Y
 Standard Cushions: High Resiliency 40 Standard Finish: N/A
 COM: 2 yards
 Features a memory swivel mechanism and a notched opening at the top back edge which provides a convenient holding spot.

D	E	F	G	H	J	K COM	L	M	N	O	P	Q	R	S	T	U	(# above U) *	S Nail	M Nail
1845	1851	1857	1863	1869	1875	1881	1887	1893	1899	1905	1911	1917	1923	1929	1935	1941	6 (Riser) + 1941 (U)	N/A	N/A

2014-07

Riley Bar Stool

Width: 22 Depth: 25.5 Height: 45.25
 AH: - SH: 31.5 SD: 18.5 IW: 20.5
 Weight: 30 / 55 lbs Cube: 14.69

Standard Pillows: N/A Finish Req: Y
 Standard Cushions: High Resiliency 40 Standard Finish: N/A
 COM: 2 yards
 Features a memory swivel mechanism and a notched opening at the top back edge which provides a convenient holding spot.

D	E	F	G	H	J	K COM	L	M	N	O	P	Q	R	S	T	U	(# above U) *	S Nail	M Nail
1845	1851	1857	1863	1869	1875	1881	1887	1893	1899	1905	1911	1917	1923	1929	1935	1941	6 (Riser) + 1941 (U)	N/A	N/A

2015-C7

Riverside Drive Counter Stool

Width: 23.5 Depth: 22.5 Height: 44.5
 AH: 39.5 SH: 27 SD: 17.5 IW: 23.5
 Weight: 23 / 33 lbs Cube: 17.77

Standard Pillows: N/A Finish Req: Y
 Standard Cushions: High Resiliency 35 Standard Finish: N/A
 COM: 2.5 yards

D	E	F	G	H	J	K COM	L	M	N	O	P	Q	R	S	T	U	(# above U) *	S Nail	M Nail
1755	1764	1773	1782	1791	1800	1809	1818	1827	1836	1845	1854	1863	1872	1881	1890	1899	9 (Riser) + 1899 (U)	Std.	N/A

2015-07

Riverside Drive Bar Stool

Width: 23.5 Depth: 22.5 Height: 48.5
 AH: 43.5 SH: 31 SD: 17.5 IW: 23.5
 Weight: 23 / 33 lbs Cube: 21.65

Standard Pillows: N/A Finish Req: Y
 Standard Cushions: High Resiliency 35 Standard Finish: N/A
 COM: 2.5 yards

D	E	F	G	H	J	K COM	L	M	N	O	P	Q	R	S	T	U	(# above U) *	S Nail	M Nail
1755	1764	1773	1782	1791	1800	1809	1818	1827	1836	1845	1854	1863	1872	1881	1890	1899	9 (Riser) + 1899 (U)	Std.	N/A

2016-C7

Doyers Street Counter Stool

Width: 22.25 Depth: 21.75 Height: 34
 AH: - SH: 27 SD: 17 IW: 22.25
 Weight: 22 / 32 lbs Cube: 15.74

Standard Pillows: N/A Finish Req: Y
 Standard Cushions: High Resiliency 40 Standard Finish: N/A
 COM: 2 yards

D	E	F	G	H	J	K COM	L	M	N	O	P	Q	R	S	T	U	(# above U) *	S Nail	M Nail
1650	1656	1662	1668	1674	1680	1686	1692	1698	1704	1710	1716	1722	1728	1734	1740	1746	6 (Riser) + 1746 (U)	Std.	N/A

2016-07

Doyers Street Bar Stool

Width: 22.25 Depth: 21.75 Height: 38
 AH: - SH: 31 SD: 17 IW: 22.25
 Weight: 22 / 32 lbs Cube: 15.74

Standard Pillows: N/A Finish Req: Y
 Standard Cushions: High Resiliency 40 Standard Finish: N/A
 COM: 2 yards

D	E	F	G	H	J	K COM	L	M	N	O	P	Q	R	S	T	U	(# above U) *	S Nail	M Nail
1650	1656	1662	1668	1674	1680	1686	1692	1698	1704	1710	1716	1722	1728	1734	1740	1746	6 (Riser) + 1746 (U)	Std.	N/A

2713-02

Granada Right Arm Facing Lounge Chair

Width: 25.5 Depth: 25.5 Height: 31.5
 AH: 31.5 SH: 19.5 SD: 20 IW: 20
 Weight: 31 / 41 lbs Cube: 15.74

Standard Pillows: N/A Finish Req: Y
 Standard Cushions: High Resiliency 30 Standard Finish: N/A
 COM: 4.5 yards

D	E	F	G	H	J	K COM	L	M	N	O	P	Q	R	S	T	U	(# above U) *	S Nail	M Nail
1575	1590	1605	1620	1635	1650	1665	1680	1695	1710	1725	1740	1755	1770	1785	1800	1815	15 (Riser) + 1815 (U)	N/A	N/A

UPHOLSTERY

2713-03

Standard Pillows: N/A Finish Req: Y
 Standard Cushions: High Resiliency 30 Standard Finish: N/A
 COM: 4.5 yards

Granada Left Arm Facing Lounge Chair

Width: 25.5 Depth: 25.5 Height: 31.5
 AH: 31.5 SH: 19.5 SD: 20 IW: 20
 Weight: 31 / 36 lbs Cube: 15.74

D	E	F	G	H	J	K _{COM}	L	M	N	O	P	Q	R	S	T	U	(# above U) *	S Nail	M Nail
1575	1590	1605	1620	1635	1650	1665	1680	1695	1710	1725	1740	1755	1770	1785	1800	1815	15 (Riser) + 1815 (U)	N/A	N/A

2713-10

Standard Pillows: N/A Finish Req: Y
 Standard Cushions: High Resiliency 30 Standard Finish: N/A
 COM: 2 yards

Granada Bench

Width: 23.5 Depth: 23.5 Height: 19.5
 AH: - SH: 19.5 SD: 23.5 IW: 23.5
 Weight: 22 / 27 lbs Cube: 10.77

D	E	F	G	H	J	K _{COM}	L	M	N	O	P	Q	R	S	T	U	(# above U) *	S Nail	M Nail
1050	1056	1062	1068	1074	1080	1086	1092	1098	1104	1110	1116	1122	1128	1134	1140	1146	6 (Riser) + 1146 (U)	N/A	N/A

2713-20

Standard Pillows: N/A Finish Req: Y
 Standard Cushions: High Resiliency 30 Standard Finish: N/A
 COM: 2 yards

Granada Ottoman

Width: 21 Depth: 23.5 Height: 19.5
 AH: - SH: 19.5 SD: 23.5 IW: 21
 Weight: 22 / 31 lbs Cube: 10.77

D	E	F	G	H	J	K _{COM}	L	M	N	O	P	Q	R	S	T	U	(# above U) *	S Nail	M Nail
1050	1056	1062	1068	1074	1080	1086	1092	1098	1104	1110	1116	1122	1128	1134	1140	1146	6 (Riser) + 1146 (U)	N/A	N/A

2713-40

Standard Pillows: N/A Finish Req: Y
 Standard Cushions: High Resiliency 30 Standard Finish: N/A
 COM: 3.5 yards

Granada Settee

Width: 32 Depth: 24.5 Height: 31
 AH: - SH: 19.5 SD: 20 IW: 32
 Weight: 31 / 46 lbs Cube: 20.21

D	E	F	G	H	J	K _{COM}	L	M	N	O	P	Q	R	S	T	U	(# above U) *	S Nail	M Nail
1560	1569	1578	1587	1596	1605	1614	1623	1632	1641	1650	1659	1668	1677	1686	1695	1704	9 (Riser) + 1704 (U)	N/A	N/A

2713-78

Standard Pillows: N/A Finish Req: Y
 Standard Cushions: High Resiliency 30 Standard Finish: N/A
 COM: 2.25 yards

Granada Armless Chair

Width: 21 Depth: 25.5 Height: 31.5
 AH: - SH: 19.5 SD: 20 IW: 21
 Weight: 25 / 30 lbs Cube: 15.74

D	E	F	G	H	J	K _{COM}	L	M	N	O	P	Q	R	S	T	U	(# above U) *	S Nail	M Nail
1290	1299	1308	1317	1326	1335	1344	1353	1362	1371	1380	1389	1398	1407	1416	1425	1434	9 (Riser) + 1434 (U)	N/A	N/A

2717-51

Standard Pillows: (2) 20 x 20 (2) 24 x 24 Finish Req: N
 Standard Cushions: High Resiliency 30 Standard Finish: traditional
 COM: 12 yards
 Coordinates with 1631-20 and 1632-20.

Madeline Right Arm Facing Sofa

Width: 90 Depth: 38 Height: 32.5
 AH: 24 SH: 18 SD: 27.5 IW: 76
 Weight: 118 / 158 lbs Cube: 92.4

D	E	F	G	H	J	K _{COM}	L	M	N	O	P	Q	R	S	T	U	(# above U) *	S Nail	M Nail
3720	3756	3792	3828	3864	3900	3936	3972	4008	4044	4080	4116	4152	4188	4224	4260	4296	36 (Riser) + 4296 (U)	105	120

2717-52

Standard Pillows: (2) 20 x 20 (2) 24 x 24 Finish Req: N
 Standard Cushions: High Resiliency 30 Standard Finish: traditional
 COM: 12 yards
 Coordinates with 1631-20 and 1632-20.

Madeline Left Arm Facing Sofa

Width: 90 Depth: 38 Height: 32.5
 AH: 24 SH: 18 SD: 27.5 IW: 76
 Weight: 118 / 118 lbs Cube: 79.34

D	E	F	G	H	J	K _{COM}	L	M	N	O	P	Q	R	S	T	U	(# above U) *	S Nail	M Nail
3720	3756	3792	3828	3864	3900	3936	3972	4008	4044	4080	4116	4152	4188	4224	4260	4296	36 (Riser) + 4296 (U)	105	120

UPHOLSTERY

2723-02

Standard Pillows: N/A Finish Req: Y
 Standard Cushions: High Resiliency 30 Standard Finish: N/A
 COM: 4.5 yards

Granada Right Arm Facing Lounge Chair

Width: 25.5 Depth: 25.5 Height: 31.5
 AH: 31.5 SH: 19.5 SD: 20 IW: 20
 Weight: 29 / 34 lbs Cube: 15.74

D	E	F	G	H	J	K _{COM}	L	M	N	O	P	Q	R	S	T	U	(# above U) *	S Nail	M Nail
1650	1665	1680	1695	1710	1725	1740	1755	1770	1785	1800	1815	1830	1845	1860	1875	1890	15 (Riser) + 1890 (U)	N/A	N/A

2723-03

Standard Pillows: N/A Finish Req: Y
 Standard Cushions: High Resiliency 30 Standard Finish: N/A
 COM: 4.5 yards

Granada Left Arm Facing Lounge Chair

Width: 25.5 Depth: 25.5 Height: 31.5
 AH: 31.5 SH: 19.5 SD: 20 IW: 20
 Weight: 29 / 34 lbs Cube: 15.74

D	E	F	G	H	J	K _{COM}	L	M	N	O	P	Q	R	S	T	U	(# above U) *	S Nail	M Nail
1650	1665	1680	1695	1710	1725	1740	1755	1770	1785	1800	1815	1830	1845	1860	1875	1890	15 (Riser) + 1890 (U)	N/A	N/A

2723-10

Standard Pillows: N/A Finish Req: Y
 Standard Cushions: High Resiliency 30 Standard Finish: N/A
 COM: 2.25 yards

Granada Bench

Width: 23.5 Depth: 23.5 Height: 19.5
 AH: - SH: 19.5 SD: 23.5 IW: 23.5
 Weight: 22 / 31 lbs Cube: 10.77

D	E	F	G	H	J	K _{COM}	L	M	N	O	P	Q	R	S	T	U	(# above U) *	S Nail	M Nail
1050	1056	1062	1068	1074	1080	1086	1092	1098	1104	1110	1116	1122	1128	1134	1140	1146	6 (Riser) + 1146 (U)	N/A	N/A

2723-20

Standard Pillows: N/A Finish Req: Y
 Standard Cushions: High Resiliency 30 Standard Finish: N/A
 COM: 2 yards

Granada Ottoman

Width: 21 Depth: 23.5 Height: 19.5
 AH: - SH: 19.5 SD: 23.5 IW: 21
 Weight: 21 / 26 lbs Cube: 10.77

D	E	F	G	H	J	K _{COM}	L	M	N	O	P	Q	R	S	T	U	(# above U) *	S Nail	M Nail
1050	1056	1062	1068	1074	1080	1086	1092	1098	1104	1110	1116	1122	1128	1134	1140	1146	6 (Riser) + 1146 (U)	N/A	N/A

2723-40

Standard Pillows: N/A Finish Req: Y
 Standard Cushions: High Resiliency 30 Standard Finish: N/A
 COM: 3.5 yards

Granada Settee

Width: 32 Depth: 24.5 Height: 31
 AH: - SH: 19.5 SD: 20 IW: 32
 Weight: 37 / 52 lbs Cube: 31.99

D	E	F	G	H	J	K _{COM}	L	M	N	O	P	Q	R	S	T	U	(# above U) *	S Nail	M Nail
1575	1584	1593	1602	1611	1620	1629	1638	1647	1656	1665	1674	1683	1692	1701	1710	1719	9 (Riser) + 1719 (U)	N/A	N/A

2723-78

Standard Pillows: N/A Finish Req: Y
 Standard Cushions: High Resiliency 30 Standard Finish: N/A
 COM: 2.25 yards

Granada Armless Chair

Width: 21 Depth: 25.5 Height: 31.5
 AH: - SH: 19.5 SD: 20 IW: 21
 Weight: 24 / 29 lbs Cube: 15.74

D	E	F	G	H	J	K _{COM}	L	M	N	O	P	Q	R	S	T	U	(# above U) *	S Nail	M Nail
1350	1359	1368	1377	1386	1395	1404	1413	1422	1431	1440	1449	1458	1467	1476	1485	1494	9 (Riser) + 1494 (U)	N/A	N/A

2724-E5

Standard Pillows: N/A Finish Req: Y
 Standard Cushions: High Resiliency 30 Standard Finish: N/A
 COM: 10.75 yards
 Features a Clean Out Seat.

Salon Sofa
 with Clean Out Seat

Width: 84.25 Depth: 32.75 Height: 30.5
 AH: 24 SH: 19 SD: 21 IW: 76.5
 Weight: 165 / 165 lbs Cube: 48.7

D	E	F	G	H	J	K _{COM}	L	M	N	O	P	Q	R	S	T	U	(# above U) *	S Nail	M Nail
3795	3828	3861	3894	3927	3960	3993	4026	4059	4092	4125	4158	4191	4224	4257	4290	4323	33 (Riser) + 4323 (U)	N/A	N/A

UPHOLSTERY

2724-E6

Salon Sofa

with Clean Out Seat

Width: 81 **Depth:** 26 **Height:** 30.5

AH: 24 **SH:** 19 **SD:** 19 **IW:** 72

Weight: 157 / 157 lbs **Cube:** 37.17

Standard Pillows: N/A **Finish Req:** Y

Standard Cushions: High Resiliency 30 **Standard Finish:** N/A

COM: 10 yards

Features a Clean Out Seat.

D	E	F	G	H	J	K _{COM}	L	M	N	O	P	Q	R	S	T	U	(# above U) *	S Nail	M Nail
3555	3585	3615	3645	3675	3705	3735	3765	3795	3825	3855	3885	3915	3945	3975	4005	4035	30 (Riser) + 4035 (U)	45	60

2731-01

Dyson Lounge Chair

Width: 34.5 **Depth:** 27.5 **Height:** 31

AH: 31 **SH:** 18.5 **SD:** 18.5 **IW:** 22

Weight: 53 / 67 lbs **Cube:** 29.69

Standard Pillows: N/A **Finish Req:** Y

Standard Cushions: High Resiliency 40 **Standard Finish:** N/A

COM: 6.25 yards

D	E	F	G	H	J	K _{COM}	L	M	N	O	P	Q	R	S	T	U	(# above U) *	S Nail	M Nail
2340	2358	2376	2394	2412	2430	2448	2466	2484	2502	2520	2538	2556	2574	2592	2610	2628	18 (Riser) + 2628 (U)	N/A	N/A

2731-50

Dyson Sofa

Width: 76.5 **Depth:** 27.5 **Height:** 31

AH: 31 **SH:** 18.5 **SD:** 18.5 **IW:** 64

Weight: 101 / 136 lbs **Cube:** 68.15

Standard Pillows: N/A **Finish Req:** Y

Standard Cushions: High Resiliency 40 **Standard Finish:** N/A

COM: 7.25 yards

D	E	F	G	H	J	K _{COM}	L	M	N	O	P	Q	R	S	T	U	(# above U) *	S Nail	M Nail
3000	3024	3048	3072	3096	3120	3144	3168	3192	3216	3240	3264	3288	3312	3336	3360	3384	24 (Riser) + 3384 (U)	N/A	N/A

2731-70

Dyson Loveseat

Width: 58 **Depth:** 28 **Height:** 30

AH: 30 **SH:** 18.5 **SD:** 19.5 **IW:** 49

Weight: 75 / 96 lbs **Cube:** 42.5

Standard Pillows: N/A **Finish Req:** Y

Standard Cushions: High Resiliency 40 **Standard Finish:** N/A

COM: 6.5 yards

D	E	F	G	H	J	K _{COM}	L	M	N	O	P	Q	R	S	T	U	(# above U) *	S Nail	M Nail
2685	2703	2721	2739	2757	2775	2793	2811	2829	2847	2865	2883	2901	2919	2937	2955	2973	18 (Riser) + 2973 (U)	N/A	N/A

2740-50

Tally Sofa

Three Backs over One Seat

Width: 88 **Depth:** 38 **Height:** 37

AH: 24.5 **SH:** 19.5 **SD:** 22.5 **IW:** 80

Weight: 120 / 120 lbs **Cube:** 71.6

Standard Pillows: (2) 20 x20 **Finish Req:** Y

Standard Cushions: Classic Plush **Standard Finish:** N/A

COM: 15.75 yards

D	E	F	G	H	J	K _{COM}	L	M	N	O	P	Q	R	S	T	U	(# above U) *	S Nail	M Nail
4275	4323	4371	4419	4467	4515	4563	4611	4659	4707	4755	4803	4851	4899	4947	4995	5043	48 (Riser) + 5043 (U)	135	N/A

2741-50

Emerson Sofa

Width: 73.25 **Depth:** 28.5 **Height:** 33.5

AH: 33 **SH:** 19.5 **SD:** 20 **IW:** 60.5

Weight: 81 / 125 lbs **Cube:** 70.78

Standard Pillows: N/A **Finish Req:** Y

Standard Cushions: High Resiliency 30 **Standard Finish:** N/A

COM: 7 yards

D	E	F	G	H	J	K _{COM}	L	M	N	O	P	Q	R	S	T	U	(# above U) *	S Nail	M Nail
3630	3651	3672	3693	3714	3735	3756	3777	3798	3819	3840	3861	3882	3903	3924	3945	3966	21 (Riser) + 3966 (U)	105	120

2743-50

Tally Sofa

Three Backs over Three Seats

Width: 88 **Depth:** 38 **Height:** 37

AH: 24.5 **SH:** 19.5 **SD:** 22.5 **IW:** 80

Weight: 120 / 120 lbs **Cube:** 71.6

Standard Pillows: (2) 20 x20 **Finish Req:** Y

Standard Cushions: Classic Plush **Standard Finish:** N/A

COM: 17 yards

D	E	F	G	H	J	K _{COM}	L	M	N	O	P	Q	R	S	T	U	(# above U) *	S Nail	M Nail
4275	4323	4371	4419	4467	4515	4563	4611	4659	4707	4755	4803	4851	4899	4947	4995	5043	48 (Riser) + 5043 (U)	135	N/A

UPHOLSTERY

400C-MR

RECLINATION

Beth Page Manual Push Back Recliner

Standard Pillows: N/A Finish Req: N

Standard Cushions: Repose Standard Finish: N/A

COM: 8.75 yards

Width: 31 Depth: 37.5 Height: 43

AH: 24.5 SH: 21.5 SD: 20 IW: 22 Recl D: 66 TV Recl: 57 Wall Clr: 16

Weight: 122 / 130 lbs Cube: 43.25

D	E	F	G	H	J	K _{COM}	L	M	N	O	P	Q	R	S	T	U	(# above U) *	S Nail	M Nail
3600	3624	3648	3672	3696	3720	3744	3768	3792	3816	3840	3864	3888	3912	3936	3960	3984	24 (Riser) + 3984 (U)	60	N/A

400C-PR

RECLINATION

Beth Page Power Recliner

Standard Pillows: N/A Finish Req: Y

Standard Cushions: Repose Standard Finish: N/A

COM: 8.75 yards

Width: 31 Depth: 37.5 Height: 43

AH: 24.5 SH: 21.5 SD: 20 IW: 22 Recl D: 66 TV Recl: 57 Wall Clr: 16

Weight: 122 / 122 lbs Cube: 28.92

D	E	F	G	H	J	K _{COM}	L	M	N	O	P	Q	R	S	T	U	(# above U) *	S Nail	M Nail
4050	4074	4098	4122	4146	4170	4194	4218	4242	4266	4290	4314	4338	4362	4386	4410	4434	24 (Riser) + 4434 (U)	60	N/A

401C-MR

RECLINATION

Pinehurst Manual Push Back Recliner

Standard Pillows: N/A Finish Req: Y

Standard Cushions: Repose Standard Finish: N/A

COM: 8 yards

Width: 31 Depth: 37.5 Height: 43

AH: 24.5 SH: 21.5 SD: 20 IW: 22 Recl D: 66 TV Recl: 57 Wall Clr: 16

Weight: 122 / 122 lbs Cube: 43.25

D	E	F	G	H	J	K _{COM}	L	M	N	O	P	Q	R	S	T	U	(# above U) *	S Nail	M Nail
3600	3624	3648	3672	3696	3720	3744	3768	3792	3816	3840	3864	3888	3912	3936	3960	3984	24 (Riser) + 3984 (U)	N/A	N/A

401C-PR

RECLINATION

Pinehurst Power Recliner

Standard Pillows: N/A Finish Req: Y

Standard Cushions: Repose Standard Finish: N/A

COM: 8 yards

Width: 31 Depth: 37.5 Height: 43

AH: 24.5 SH: 21.5 SD: 20 IW: 22 Recl D: 66 TV Recl: 57 Wall Clr: 16

Weight: 122 / 122 lbs Cube: 43.25

D	E	F	G	H	J	K _{COM}	L	M	N	O	P	Q	R	S	T	U	(# above U) *	S Nail	M Nail
4050	4074	4098	4122	4146	4170	4194	4218	4242	4266	4290	4314	4338	4362	4386	4410	4434	24 (Riser) + 4434 (U)	N/A	N/A

402C-MR

RECLINATION

St. Andrews Manual Push Back Recliner

Standard Pillows: N/A Finish Req: Y

Standard Cushions: Repose Standard Finish: N/A

COM: 8.75 yards

Width: 31 Depth: 37.5 Height: 43

AH: 24.5 SH: 21.5 SD: 20 IW: 22 Recl D: 66 TV Recl: 57 Wall Clr: 16

Weight: 122 / 122 lbs Cube: 43.25

D	E	F	G	H	J	K _{COM}	L	M	N	O	P	Q	R	S	T	U	(# above U) *	S Nail	M Nail
3600	3624	3648	3672	3696	3720	3744	3768	3792	3816	3840	3864	3888	3912	3936	3960	3984	24 (Riser) + 3984 (U)	60	N/A

402C-PR

RECLINATION

St. Andrews Power Recliner

Standard Pillows: N/A Finish Req: Y

Standard Cushions: Repose Standard Finish: N/A

COM: 8.75 yards

Width: 31 Depth: 37.5 Height: 43

AH: 24.5 SH: 21.5 SD: 20 IW: 22 Recl D: 66 TV Recl: 57 Wall Clr: 16

Weight: 122 / 122 lbs Cube: 28.92

D	E	F	G	H	J	K _{COM}	L	M	N	O	P	Q	R	S	T	U	(# above U) *	S Nail	M Nail
4050	4074	4098	4122	4146	4170	4194	4218	4242	4266	4290	4314	4338	4362	4386	4410	4434	24 (Riser) + 4434 (U)	60	N/A

403C-MR

RECLINATION

Spyglass Manual Push Back Recliner

Standard Pillows: N/A Finish Req: Y

Standard Cushions: Repose Standard Finish: N/A

COM: 7.75 yards

Width: 31 Depth: 37.5 Height: 43

AH: 24.5 SH: 21.5 SD: 20 IW: 22 Recl D: 66 TV Recl: 57 Wall Clr: 16

Weight: 122 / 122 lbs Cube: 28.92

D	E	F	G	H	J	K _{COM}	L	M	N	O	P	Q	R	S	T	U	(# above U) *	S Nail	M Nail
3600	3624	3648	3672	3696	3720	3744	3768	3792	3816	3840	3864	3888	3912	3936	3960	3984	24 (Riser) + 3984 (U)	60	N/A

UPHOLSTERY

403C-PR
RECLINATION
Spyglass Power Recliner

Standard Pillows: N/A **Finish Req:** Y
Standard Cushions: Repose **Standard Finish:** N/A
COM: 7.75 yards

Width: 31 **Depth:** 37.5 **Height:** 43
AH: 24.5 **SH:** 21.5 **SD:** 20 **IW:** 22 **Recl D:** 66 **TV Recl:** 57 **Wall Clr:** 16
Weight: 122 / 122 lbs **Cube:** 28.92

D	E	F	G	H	J	K _{COM}	L	M	N	O	P	Q	R	S	T	U	(# above U) *	S Nail	M Nail
4050	4074	4098	4122	4146	4170	4194	4218	4242	4266	4290	4314	4338	4362	4386	4410	4434	24 (Riser) + 4434 (U)	60	N/A

408C-MR
RECLINATION
Harbour Town Manual Push Back Recliner

Standard Pillows: N/A **Finish Req:** Y
Standard Cushions: Repose **Standard Finish:** N/A
COM: 8.25 yards

Width: 33 **Depth:** 37.5 **Height:** 44
AH: 25.5 **SH:** 21 **SD:** 20 **IW:** 22 **Recl D:** 66 **TV Recl:** 57 **Wall Clr:** 16
Weight: 122 / 122 lbs **Cube:** 43.25

D	E	F	G	H	J	K _{COM}	L	M	N	O	P	Q	R	S	T	U	(# above U) *	S Nail	M Nail
3675	3699	3723	3747	3771	3795	3819	3843	3867	3891	3915	3939	3963	3987	4011	4035	4059	24 (Riser) + 4059 (U)	45	N/A

408C-PR
RECLINATION
Harbour Town Power Recliner

Standard Pillows: N/A **Finish Req:** Y
Standard Cushions: Repose **Standard Finish:** N/A
COM: 8.25 yards

Width: 33 **Depth:** 37.5 **Height:** 44
AH: 25.5 **SH:** 21 **SD:** 20 **IW:** 22 **Recl D:** 66 **TV Recl:** 57 **Wall Clr:** 16
Weight: 122 / 122 lbs **Cube:** 43.25

D	E	F	G	H	J	K _{COM}	L	M	N	O	P	Q	R	S	T	U	(# above U) *	S Nail	M Nail
4125	4149	4173	4197	4221	4245	4269	4293	4317	4341	4365	4389	4413	4437	4461	4485	4509	24 (Riser) + 4509 (U)	45	N/A

410C-MR
RECLINATION
Dale Manual Push Back Recliner

Standard Pillows: N/A **Finish Req:** Y
Standard Cushions: Repose **Standard Finish:** N/A
COM: 10 yards

Width: 33 **Depth:** 39.5 **Height:** 41
AH: 24 **SH:** 21.5 **SD:** 21 **IW:** 23 **Recl D:** 67.5 **TV Recl:** 56 **Wall Clr:** 17
Weight: 102 / 121 lbs **Cube:** 43.25

D	E	F	G	H	J	K _{COM}	L	M	N	O	P	Q	R	S	T	U	(# above U) *	S Nail	M Nail
3600	3627	3654	3681	3708	3735	3762	3789	3816	3843	3870	3897	3924	3951	3978	4005	4032	27 (Riser) + 4032 (U)	120	135

410C-PR
RECLINATION
Dale Power Recliner

Standard Pillows: N/A **Finish Req:** Y
Standard Cushions: Repose **Standard Finish:** N/A
COM: 10 yards

Width: 33 **Depth:** 39.5 **Height:** 41
AH: 24 **SH:** 21.5 **SD:** 21 **IW:** 23 **Recl D:** 67.5 **TV Recl:** 56 **Wall Clr:** 17
Weight: 102 / 121 lbs **Cube:** 43.25

D	E	F	G	H	J	K _{COM}	L	M	N	O	P	Q	R	S	T	U	(# above U) *	S Nail	M Nail
4050	4077	4104	4131	4158	4185	4212	4239	4266	4293	4320	4347	4374	4401	4428	4455	4482	27 (Riser) + 4482 (U)	120	135

411C-MR
RECLINATION
Newberry Manual Push Back Recliner

Standard Pillows: N/A **Finish Req:** Y
Standard Cushions: Repose **Standard Finish:** N/A
COM: 8.75 yards

Width: 30 **Depth:** 40 **Height:** 42
AH: 26.5 **SH:** 22.5 **SD:** 20 **IW:** 21.5 **Recl D:** 68 **TV Recl:** 58 **Wall Clr:** 17.5
Weight: 119 / 138 lbs **Cube:** 43.25

D	E	F	G	H	J	K _{COM}	L	M	N	O	P	Q	R	S	T	U	(# above U) *	S Nail	M Nail
3450	3474	3498	3522	3546	3570	3594	3618	3642	3666	3690	3714	3738	3762	3786	3810	3834	24 (Riser) + 3834 (U)	105	120

411C-PR
RECLINATION
Newberry Power Recliner
with Power Recline

Standard Pillows: N/A **Finish Req:** Y
Standard Cushions: Repose **Standard Finish:** N/A
COM: 8.75 yards

Width: 30 **Depth:** 40 **Height:** 42
AH: 26.5 **SH:** 22.5 **SD:** 20 **IW:** 21.5 **Recl D:** 68 **TV Recl:** 58 **Wall Clr:** 17.5
Weight: 119 / 138 lbs **Cube:** 43.25

D	E	F	G	H	J	K _{COM}	L	M	N	O	P	Q	R	S	T	U	(# above U) *	S Nail	M Nail
3900	3924	3948	3972	3996	4020	4044	4068	4092	4116	4140	4164	4188	4212	4236	4260	4284	24 (Riser) + 4284 (U)	105	120

UPHOLSTERY

450F-PL

RECLINATION

Drake Power Lift Recliner

with Power Recline

Width: 29 Depth: 36.5 Height: 40.75

AH: 24.5 SH: 21 SD: 20 IW: 20.5 Recl D: 66 TV Recl: 54.5 Wall Clr: 5

Weight: 129 / 129 lbs Cube: 24.96

Standard Pillows: N/A Finish Req: N

Standard Cushions: Repose Standard Finish: N/A

COM: 8.25 yards

Features Dual Motors

D	E	F	G	H	J	K _{COM}	L	M	N	O	P	Q	R	S	T	U	(# above U) *	S Nail	M Nail
5250	5274	5298	5322	5346	5370	5394	5418	5442	5466	5490	5514	5538	5562	5586	5610	5634	24 (Riser) + 5634 (U)	45	N/A

450G-MR

RECLINATION

Drake Manual Push Back Swivel Glider Recliner

Width: 29 Depth: 36.5 Height: 40.75

AH: 24.5 SH: 21 SD: 20 IW: 20.5 Recl D: 66 TV Recl: 54.5 Wall Clr: 12

Weight: 129 / 129 lbs Cube: 24.96

Standard Pillows: N/A Finish Req: N

Standard Cushions: Repose Standard Finish: N/A

COM: 8.25 yards

D	E	F	G	H	J	K _{COM}	L	M	N	O	P	Q	R	S	T	U	(# above U) *	S Nail	M Nail
3900	3924	3948	3972	3996	4020	4044	4068	4092	4116	4140	4164	4188	4212	4236	4260	4284	24 (Riser) + 4284 (U)	45	N/A

450G-PR

RECLINATION

Drake Power Swivel Glider Recliner

Width: 29 Depth: 36.5 Height: 40.75

AH: 24.5 SH: 21 SD: 20 IW: 20.5 Recl D: 66 TV Recl: 54.5 Wall Clr: 12

Weight: 129 / 129 lbs Cube: 24.96

Standard Pillows: N/A Finish Req: N

Standard Cushions: Repose Standard Finish: N/A

COM: 8.25 yards

D	E	F	G	H	J	K _{COM}	L	M	N	O	P	Q	R	S	T	U	(# above U) *	S Nail	M Nail
4350	4374	4398	4422	4446	4470	4494	4518	4542	4566	4590	4614	4638	4662	4686	4710	4734	24 (Riser) + 4734 (U)	45	N/A

450K-MR

RECLINATION

Drake Manual Push Back Recline Glider

Width: 29 Depth: 36.5 Height: 40.75

AH: 24.5 SH: 21 SD: 20 IW: 20.5 Recl D: 66 TV Recl: 54.5 Wall Clr: 12

Weight: 129 / 129 lbs Cube: 24.96

Standard Pillows: N/A Finish Req: N

Standard Cushions: Repose Standard Finish: N/A

COM: 8.25 yards

D	E	F	G	H	J	K _{COM}	L	M	N	O	P	Q	R	S	T	U	(# above U) *	S Nail	M Nail
3900	3924	3948	3972	3996	4020	4044	4068	4092	4116	4140	4164	4188	4212	4236	4260	4284	24 (Riser) + 4284 (U)	45	N/A

450K-PR

RECLINATION

Drake Power Glider Recliner

with Power Recline

Width: 29 Depth: 36.5 Height: 40.75

AH: 24.5 SH: 21 SD: 20 IW: 20.5 Recl D: 66 TV Recl: 54.5 Wall Clr: 12

Weight: 129 / 129 lbs Cube: 43.25

Standard Pillows: N/A Finish Req: N

Standard Cushions: Repose Standard Finish: N/A

COM: 8.25 yards

D	E	F	G	H	J	K _{COM}	L	M	N	O	P	Q	R	S	T	U	(# above U) *	S Nail	M Nail
4350	4374	4398	4422	4446	4470	4494	4518	4542	4566	4590	4614	4638	4662	4686	4710	4734	24 (Riser) + 4734 (U)	45	N/A

450Z-MR

RECLINATION

Drake Manual Wall Hugger Recliner

with Zero Wall Recline

Width: 29 Depth: 36.5 Height: 40.75

AH: 24.5 SH: 21 SD: 20 IW: 20.5 Recl D: 66 TV Recl: 54.5 Wall Clr: 3.5

Weight: 129 / 129 lbs Cube: 24.96

Standard Pillows: N/A Finish Req: N

Standard Cushions: Repose Standard Finish: N/A

COM: 8.25 yards

D	E	F	G	H	J	K _{COM}	L	M	N	O	P	Q	R	S	T	U	(# above U) *	S Nail	M Nail
3675	3699	3723	3747	3771	3795	3819	3843	3867	3891	3915	3939	3963	3987	4011	4035	4059	24 (Riser) + 4059 (U)	45	N/A

450Z-PR

RECLINATION

Drake Power Wall Hugger Recliner

Width: 29 Depth: 36.5 Height: 40.75

AH: 24.5 SH: 21 SD: 20 IW: 20.5 Recl D: 66 TV Recl: 54.5 Wall Clr: 3.5

Weight: 129 / 129 lbs Cube: 24.96

Standard Pillows: N/A Finish Req: N

Standard Cushions: Repose Standard Finish: N/A

COM: 8.25 yards

D	E	F	G	H	J	K _{COM}	L	M	N	O	P	Q	R	S	T	U	(# above U) *	S Nail	M Nail
4125	4149	4173	4197	4221	4245	4269	4293	4317	4341	4365	4389	4413	4437	4461	4485	4509	24 (Riser) + 4509 (U)	45	N/A

UPHOLSTERY

4500-10

BD COLLECTION FOR FAIRFIELD
Ofis Bench

Standard Pillows: N/A Finish Req: Y
Standard Cushions: High Resiliency 40 Standard Finish: N/A
COM: 4.5 yards

Width: 60 Depth: 24 Height: 36
AH: 25.25 SH: 19.5 SD: 19 IW: 57
Weight: 46 / 56 lbs Cube: 44.07

D	E	F	G	H	J	K _{COM}	L	M	N	O	P	Q	R	S	T	U	(# above U) *	S Nail	M Nail
2850	2865	2880	2895	2910	2925	2940	2955	2970	2985	3000	3015	3030	3045	3060	3075	3090	15 (Riser) + 3090 (U)	150	N/A

4501-10

BD COLLECTION FOR FAIRFIELD
Sofia Bench

Standard Pillows: N/A Finish Req: Y
Standard Cushions: High Resiliency 40 Standard Finish: N/A
COM: 2.5 yards

Width: 61.25 Depth: 24.5 Height: 36
AH: 23 SH: 19 SD: 21.5 IW: 57
Weight: 53 / 63 lbs Cube: 20.19

D	E	F	G	H	J	K _{COM}	L	M	N	O	P	Q	R	S	T	U	(# above U) *	S Nail	M Nail
3825	3834	3843	3852	3861	3870	3879	3888	3897	3906	3915	3924	3933	3942	3951	3960	3969	9 (Riser) + 3969 (U)	N/A	N/A

4502-10

BD COLLECTION FOR FAIRFIELD
Lynn Bench

Standard Pillows: N/A Finish Req: Y
Standard Cushions: High Resiliency 40 Standard Finish: N/A
COM: 2.75 yards

Width: 60.75 Depth: 21.5 Height: 18.5
AH: - SH: 18.5 SD: 21.5 IW: 60.75
Weight: 50 / 60 lbs Cube: 23.16

D	E	F	G	H	J	K _{COM}	L	M	N	O	P	Q	R	S	T	U	(# above U) *	S Nail	M Nail
1710	1722	1734	1746	1758	1770	1782	1794	1806	1818	1830	1842	1854	1866	1878	1890	1902	12 (Riser) + 1902 (U)	N/A	N/A

4503-10

BD COLLECTION FOR FAIRFIELD
Cathy Bench

Standard Pillows: N/A Finish Req: Y
Standard Cushions: High Resiliency 40 Standard Finish: N/A
COM: 5.5 yards

Width: 60.75 Depth: 26 Height: 36.5
AH: 23.75 SH: 19.5 SD: 18 IW: 50
Weight: 64 / 74 lbs Cube: 55.51

D	E	F	G	H	J	K _{COM}	L	M	N	O	P	Q	R	S	T	U	(# above U) *	S Nail	M Nail
2850	2868	2886	2904	2922	2940	2958	2976	2994	3012	3030	3048	3066	3084	3102	3120	3138	18 (Riser) + 3138 (U)	N/A	N/A

451F-PL

RECLINATION

Nolan Power Lift Recliner
with Power Lift and Recline

Standard Pillows: N/A Finish Req: N
Standard Cushions: Repose Standard Finish: N/A
COM: 7.5 yards
Features Dual Motors

Width: 29 Depth: 36.5 Height: 40.75
AH: 24.5 SH: 21 SD: 20 IW: 20.5 Recl D: 66 TV Recl: 54.5 Wall Cir: 5
Weight: 129 / 148 lbs Cube: 43.25

D	E	F	G	H	J	K _{COM}	L	M	N	O	P	Q	R	S	T	U	(# above U) *	S Nail	M Nail
4800	4824	4848	4872	4896	4920	4944	4968	4992	5016	5040	5064	5088	5112	5136	5160	5184	24 (Riser) + 5184 (U)	45	N/A

451G-MR

RECLINATION

Nolan Manual Swivel Glider Recliner

Standard Pillows: N/A Finish Req: N
Standard Cushions: Repose Standard Finish: N/A
COM: 7.75 yards

Width: 29 Depth: 36.5 Height: 40.75
AH: 24.5 SH: 21 SD: 20 IW: 20.5 Recl D: 66 TV Recl: 54.5 Wall Cir: 12
Weight: 129 / 129 lbs Cube: 29.69

D	E	F	G	H	J	K _{COM}	L	M	N	O	P	Q	R	S	T	U	(# above U) *	S Nail	M Nail
3600	3624	3648	3672	3696	3720	3744	3768	3792	3816	3840	3864	3888	3912	3936	3960	3984	24 (Riser) + 3984 (U)	45	N/A

451G-PR

RECLINATION

Nolan Power Swivel Glider Recliner
with Power Recline

Standard Pillows: N/A Finish Req: N
Standard Cushions: Repose Standard Finish: N/A
COM: 7.75 yards

Width: 29 Depth: 36.5 Height: 40.75
AH: 24.5 SH: 21 SD: 20 IW: 20.5 Recl D: 66 TV Recl: 54.5 Wall Cir: 12
Weight: 129 / 129 lbs Cube: 24.96

D	E	F	G	H	J	K _{COM}	L	M	N	O	P	Q	R	S	T	U	(# above U) *	S Nail	M Nail
4050	4074	4098	4122	4146	4170	4194	4218	4242	4266	4290	4314	4338	4362	4386	4410	4434	24 (Riser) + 4434 (U)	45	N/A

UPHOLSTERY

451K-MR

RECLINATION

Nolan Manual Glider Recliner

Standard Pillows: N/A Finish Req: N

Standard Cushions: Repose Standard Finish: N/A

COM: 7.75 yards

Width: 29 Depth: 36.5 Height: 40.75

AH: 24.5 SH: 21 SD: 20 IW: 20.5 Recl D: 66 TV Recl: 54.5 Wall Clr: 12

Weight: 129 / 129 lbs Cube: 24.96

D	E	F	G	H	J	K _{COM}	L	M	N	O	P	Q	R	S	T	U	(# above U) *	S Nail	M Nail
3600	3624	3648	3672	3696	3720	3744	3768	3792	3816	3840	3864	3888	3912	3936	3960	3984	24 (Riser) + 3984 (U)	45	N/A

451K-PR

RECLINATION

Nolan Power Glider Recliner

with Power Recline

Standard Pillows: N/A Finish Req: N

Standard Cushions: Repose Standard Finish: N/A

COM: 7.75 yards

Width: 29 Depth: 36.5 Height: 40.75

AH: 24.5 SH: 21 SD: 20 IW: 20.5 Recl D: 66 TV Recl: 54.5 Wall Clr: 12

Weight: 129 / 129 lbs Cube: 24.96

D	E	F	G	H	J	K _{COM}	L	M	N	O	P	Q	R	S	T	U	(# above U) *	S Nail	M Nail
4050	4074	4098	4122	4146	4170	4194	4218	4242	4266	4290	4314	4338	4362	4386	4410	4434	24 (Riser) + 4434 (U)	45	N/A

451Z-MR

RECLINATION

Nolan Manual Wall Hugger Recliner

with Zero Wall Recline

Standard Pillows: N/A Finish Req: N

Standard Cushions: Repose Standard Finish: N/A

COM: 7.75 yards

Width: 29 Depth: 36.5 Height: 40.75

AH: 24.5 SH: 21 SD: 20 IW: 20.5 Recl D: 66 TV Recl: 54.5 Wall Clr: 3.5

Weight: 129 / 129 lbs Cube: 24.96

D	E	F	G	H	J	K _{COM}	L	M	N	O	P	Q	R	S	T	U	(# above U) *	S Nail	M Nail
3300	3324	3348	3372	3396	3420	3444	3468	3492	3516	3540	3564	3588	3612	3636	3660	3684	24 (Riser) + 3684 (U)	45	N/A

451Z-PR

RECLINATION

Nolan Power Wall Hugger Recliner

Standard Pillows: N/A Finish Req: N

Standard Cushions: Repose Standard Finish: N/A

COM: 7.75 yards

Width: 29 Depth: 36.5 Height: 40.75

AH: 24.5 SH: 21 SD: 20 IW: 20.5 Recl D: 66 TV Recl: 54.5 Wall Clr: 3.5

Weight: 129 / 129 lbs Cube: 24.96

D	E	F	G	H	J	K _{COM}	L	M	N	O	P	Q	R	S	T	U	(# above U) *	S Nail	M Nail
3750	3774	3798	3822	3846	3870	3894	3918	3942	3966	3990	4014	4038	4062	4086	4110	4134	24 (Riser) + 4134 (U)	45	N/A

452F-PL

RECLINATION

Track Arm Power Lift Recliner

with Power Lift and Recline

Standard Pillows: N/A Finish Req: N

Standard Cushions: Endurance Standard Finish: N/A

COM: 7.5 yards

Features Dual Motors and a lift motion control switch on the inside of the left side facing arm.

Width: 29 Depth: 36.5 Height: 40.75

AH: 24.5 SH: 18.5 SD: 21 IW: 20.5 Recl D: 66 TV Recl: 54.5 Wall Clr: 5

Weight: 123 / 123 lbs Cube: 24.96

D	E	F	G	H	J	K _{COM}	L	M	N	O	P	Q	R	S	T	U	(# above U) *	S Nail	M Nail
4875	4896	4917	4938	4959	4980	5001	5022	5043	5064	5085	5106	5127	5148	5169	5190	5211	21 (Riser) + 5211 (U)	N/A	N/A

452G-MR

RECLINATION

Track Arm Manual Swivel Glider Recliner

Standard Pillows: N/A Finish Req: N

Standard Cushions: Repose Standard Finish: N/A

COM: 7.5 yards

Width: 29 Depth: 36.5 Height: 40.75

AH: 24.5 SH: 20.25 SD: 21 IW: 20.5 Recl D: 66 TV Recl: 54.5 Wall Clr: 12

Weight: 123 / 123 lbs Cube: 43.25

D	E	F	G	H	J	K _{COM}	L	M	N	O	P	Q	R	S	T	U	(# above U) *	S Nail	M Nail
3600	3621	3642	3663	3684	3705	3726	3747	3768	3789	3810	3831	3852	3873	3894	3915	3936	21 (Riser) + 3936 (U)	N/A	N/A

452G-PR

RECLINATION

Track Arm Power Swivel Glider Recliner

Standard Pillows: N/A Finish Req: N

Standard Cushions: Repose Standard Finish: N/A

COM: 7.5 yards

Width: 29 Depth: 36.5 Height: 40.75

AH: 24.5 SH: 20.25 SD: 21 IW: 20.5 Recl D: 66 TV Recl: 54.5 Wall Clr: 12

Weight: 123 / 123 lbs Cube: 24.96

D	E	F	G	H	J	K _{COM}	L	M	N	O	P	Q	R	S	T	U	(# above U) *	S Nail	M Nail
4050	4071	4092	4113	4134	4155	4176	4197	4218	4239	4260	4281	4302	4323	4344	4365	4386	21 (Riser) + 4386 (U)	N/A	N/A

UPHOLSTERY

452K-MR

RECLINATION

Track Arm Manual Glider Recliner

Standard Pillows: N/A Finish Req: N

Standard Cushions: Repose Standard Finish: N/A

COM: 7.5 yards

Width: 29 Depth: 36.5 Height: 40.75

AH: 24.5 SH: 20.25 SD: 21 IW: 20.5 Recl D: 66 TV Recl: 54.5 Wall Clr: 12

Weight: 123 / 123 lbs Cube: 24.96

D	E	F	G	H	J	K _{COM}	L	M	N	O	P	Q	R	S	T	U	(# above U) *	S Nail	M Nail
3600	3621	3642	3663	3684	3705	3726	3747	3768	3789	3810	3831	3852	3873	3894	3915	3936	21 (Riser) + 3936 (U)	N/A	N/A

452K-PR

RECLINATION

Track Arm Power Glider Recliner

with Power Recline

Standard Pillows: N/A Finish Req: N

Standard Cushions: Repose Standard Finish: N/A

COM: 7.5 yards

Features a motor control switch on the inside of the left side facing arm.

Width: 29 Depth: 36.5 Height: 40.75

AH: 24.5 SH: 20.25 SD: 21 IW: 20.5 Recl D: 66 TV Recl: 54.5 Wall Clr: 12

Weight: 123 / 123 lbs Cube: 24.96

D	E	F	G	H	J	K _{COM}	L	M	N	O	P	Q	R	S	T	U	(# above U) *	S Nail	M Nail
4050	4071	4092	4113	4134	4155	4176	4197	4218	4239	4260	4281	4302	4323	4344	4365	4386	21 (Riser) + 4386 (U)	N/A	N/A

452Z-MR

RECLINATION

Track Arm Manual Wall Hugger Recliner

Standard Pillows: N/A Finish Req: N

Standard Cushions: Repose Standard Finish: N/A

COM: 7.5 yards

Width: 29 Depth: 36.5 Height: 40.75

AH: 24.5 SH: 20.25 SD: 21 IW: 20.5 Recl D: 66 TV Recl: 54.5 Wall Clr: 3.5

Weight: 123 / 123 lbs Cube: 24.96

D	E	F	G	H	J	K _{COM}	L	M	N	O	P	Q	R	S	T	U	(# above U) *	S Nail	M Nail
3300	3321	3342	3363	3384	3405	3426	3447	3468	3489	3510	3531	3552	3573	3594	3615	3636	21 (Riser) + 3636 (U)	N/A	N/A

452Z-PR

RECLINATION

Track Arm Power Wall Hugger Recliner

Standard Pillows: N/A Finish Req: N

Standard Cushions: Repose Standard Finish: N/A

COM: 7.5 yards

Features dual motors and a motor control switch on the inside of the left side facing arm.

Width: 29 Depth: 36.5 Height: 40.75

AH: 24.5 SH: 20.25 SD: 21 IW: 20.5 Recl D: 66 TV Recl: 54.5 Wall Clr: 3.5

Weight: 123 / 123 lbs Cube: 41.32

D	E	F	G	H	J	K _{COM}	L	M	N	O	P	Q	R	S	T	U	(# above U) *	S Nail	M Nail
3750	3771	3792	3813	3834	3855	3876	3897	3918	3939	3960	3981	4002	4023	4044	4065	4086	21 (Riser) + 4086 (U)	N/A	N/A

453G-MR

RECLINATION

Greek Key Arm Manual Swivel Glider Recliner

Standard Pillows: N/A Finish Req: N

Standard Cushions: Repose Standard Finish: N/A

COM: 7.5 yards

Width: 32.5 Depth: 36.5 Height: 40.75

AH: 24.25 SH: 20.25 SD: 21 IW: 20.5 Recl D: 66 TV Recl: 54.5 Wall Clr: 12

Weight: 123 / 123 lbs Cube: 43.25

D	E	F	G	H	J	K _{COM}	L	M	N	O	P	Q	R	S	T	U	(# above U) *	S Nail	M Nail
3600	3621	3642	3663	3684	3705	3726	3747	3768	3789	3810	3831	3852	3873	3894	3915	3936	21 (Riser) + 3936 (U)	N/A	N/A

453G-PR

RECLINATION

Greek Key Arm Power Swivel Glider Recliner

Standard Pillows: N/A Finish Req: N

Standard Cushions: Repose Standard Finish: N/A

COM: 7.5 yards

Features a motion control switch on the outside of the left side facing arm.

Width: 32.5 Depth: 36.5 Height: 40.75

AH: 25 SH: 20.25 SD: 21 IW: 20.5 Recl D: 66 TV Recl: 54.5 Wall Clr: 12

Weight: 123 / 123 lbs Cube: 27.97

D	E	F	G	H	J	K _{COM}	L	M	N	O	P	Q	R	S	T	U	(# above U) *	S Nail	M Nail
4050	4071	4092	4113	4134	4155	4176	4197	4218	4239	4260	4281	4302	4323	4344	4365	4386	21 (Riser) + 4386 (U)	N/A	N/A

454F-PL

RECLINATION

Modern Arm Power Lift Recliner

with Power Lift and Recline

Standard Pillows: N/A Finish Req: N

Standard Cushions: Endurance Standard Finish: N/A

COM: 7.5 yards

Features dual motors and a lift motion control switch on the top of the left side facing arm.

Width: 31.5 Depth: 36.5 Height: 40.75

AH: 24.75 SH: 18.5 SD: 21 IW: 20.5 Recl D: 66 TV Recl: 54.5 Wall Clr: 5

Weight: 123 / 123 lbs Cube: 34.38

D	E	F	G	H	J	K _{COM}	L	M	N	O	P	Q	R	S	T	U	(# above U) *	S Nail	M Nail
4950	4971	4992	5013	5034	5055	5076	5097	5118	5139	5160	5181	5202	5223	5244	5265	5286	21 (Riser) + 5286 (U)	N/A	N/A

UPHOLSTERY

454G-MR

RECLINATION

Modern Arm Manual Swivel Glider Recliner

Standard Pillows: N/A Finish Req: N

Standard Cushions: Repose Standard Finish: N/A

COM: 7.5 yards

Width: 31.5 Depth: 36.5 Height: 40.75

AH: 24.75 SH: 20.25 SD: 21 IW: 20.5 Recl D: 66 TV Recl: 54.5 Wall Clr: 12

Weight: 123 / 123 lbs Cube: 27.11

D	E	F	G	H	J	K _{COM}	L	M	N	O	P	Q	R	S	T	U	(# above U) *	S Nail	M Nail
3600	3621	3642	3663	3684	3705	3726	3747	3768	3789	3810	3831	3852	3873	3894	3915	3936	21 (Riser) + 3936 (U)	N/A	N/A

454G-PR

RECLINATION

Modern Arm Power Swivel Glider Recliner

Standard Pillows: N/A Finish Req: N

Standard Cushions: Repose Standard Finish: N/A

COM: 7.5 yards

Width: 31.5 Depth: 36.5 Height: 40.75

AH: 24.75 SH: 20.25 SD: 21 IW: 20.5 Recl D: 66 TV Recl: 54.5 Wall Clr: 12

Weight: 123 / 123 lbs Cube: 27.11

D	E	F	G	H	J	K _{COM}	L	M	N	O	P	Q	R	S	T	U	(# above U) *	S Nail	M Nail
4050	4071	4092	4113	4134	4155	4176	4197	4218	4239	4260	4281	4302	4323	4344	4365	4386	21 (Riser) + 4386 (U)	N/A	N/A

454Z-MR

RECLINATION

Modern Arm Manual Wall Hugger Recliner

with Zero Wall Recline

Standard Pillows: N/A Finish Req: N

Standard Cushions: Repose Standard Finish: N/A

COM: 7.5 yards

Width: 31.5 Depth: 36.5 Height: 40.75

AH: 24.75 SH: 20.25 SD: 21 IW: 20.5 Recl D: 66 TV Recl: 54.5 Wall Clr: 3.5

Weight: 123 / 142 lbs Cube: 43.25

D	E	F	G	H	J	K _{COM}	L	M	N	O	P	Q	R	S	T	U	(# above U) *	S Nail	M Nail
3300	3321	3342	3363	3384	3405	3426	3447	3468	3489	3510	3531	3552	3573	3594	3615	3636	21 (Riser) + 3636 (U)	N/A	N/A

454Z-PR

RECLINATION

Modern Arm Power Wall Hugger Recliner

Standard Pillows: N/A Finish Req: N

Standard Cushions: Repose Standard Finish: N/A

COM: 7.5 yards

Features a motion control switch on the outside of the left side facing arm.

Width: 31.5 Depth: 36.5 Height: 40.75

AH: 24.75 SH: 20.25 SD: 21 IW: 20.5 Recl D: 66 TV Recl: 54.5 Wall Clr: 3.5

Weight: 123 / 142 lbs Cube: 43.25

D	E	F	G	H	J	K _{COM}	L	M	N	O	P	Q	R	S	T	U	(# above U) *	S Nail	M Nail
3750	3771	3792	3813	3834	3855	3876	3897	3918	3939	3960	3981	4002	4023	4044	4065	4086	21 (Riser) + 4086 (U)	N/A	N/A

455G-MR

RECLINATION

Hickory Arm Manual Swivel Glider Recliner

Standard Pillows: N/A Finish Req: N

Standard Cushions: Repose Standard Finish: N/A

COM: 7.5 yards

Width: 31 Depth: 36.5 Height: 40.75

AH: 24.75 SH: 20.25 SD: 21 IW: 20.5 Recl D: 66 TV Recl: 54.5 Wall Clr: 12

Weight: 123 / 123 lbs Cube: 26.68

D	E	F	G	H	J	K _{COM}	L	M	N	O	P	Q	R	S	T	U	(# above U) *	S Nail	M Nail
3600	3621	3642	3663	3684	3705	3726	3747	3768	3789	3810	3831	3852	3873	3894	3915	3936	21 (Riser) + 3936 (U)	N/A	N/A

455G-PR

RECLINATION

Hickory Arm Power Swivel Glider Recliner

Standard Pillows: N/A Finish Req: N

Standard Cushions: Repose Standard Finish: N/A

COM: 7.5 yards

Features a motion control switch on the outside of the left side facing arm.

Width: 31 Depth: 36.5 Height: 40.75

AH: 24.75 SH: 20.25 SD: 21 IW: 20.5 Recl D: 66 TV Recl: 54.5 Wall Clr: 12

Weight: 123 / 123 lbs Cube: 26.68

D	E	F	G	H	J	K _{COM}	L	M	N	O	P	Q	R	S	T	U	(# above U) *	S Nail	M Nail
4050	4071	4092	4113	4134	4155	4176	4197	4218	4239	4260	4281	4302	4323	4344	4365	4386	21 (Riser) + 4386 (U)	N/A	N/A

456F-PL

RECLINATION

Roll Arm Power Lift Recliner

with Power Lift and Recline

Standard Pillows: N/A Finish Req: N

Standard Cushions: Endurance Standard Finish: N/A

COM: 7.5 yards

Features dual motors and a lift motion control switch on the top of the left side facing arm.

Width: 32.5 Depth: 36.5 Height: 40.75

AH: 25 SH: 18.5 SD: 21 IW: 20.5 Recl D: 66 TV Recl: 54.5 Wall Clr: 5

Weight: 123 / 123 lbs Cube: 27.97

D	E	F	G	H	J	K _{COM}	L	M	N	O	P	Q	R	S	T	U	(# above U) *	S Nail	M Nail
4950	4971	4992	5013	5034	5055	5076	5097	5118	5139	5160	5181	5202	5223	5244	5265	5286	21 (Riser) + 5286 (U)	45	N/A

UPHOLSTERY

456G-MR

RECLINATION

Roll Arm Manual Swivel Glider Recliner

Standard Pillows: N/A Finish Req: N

Standard Cushions: Repose Standard Finish: N/A

COM: 7.75 yards

Width: 32.5 Depth: 36.5 Height: 40.75

AH: 25 SH: 20.25 SD: 21 IW: 20.5 Recl D: 66 TV Recl: 54.5 Wall Clr: 12

Weight: 123 / 123 lbs Cube: 27.97

D	E	F	G	H	J	K _{COM}	L	M	N	O	P	Q	R	S	T	U	(# above U) *	S Nail	M Nail
3600	3621	3642	3663	3684	3705	3726	3747	3768	3789	3810	3831	3852	3873	3894	3915	3936	21 (Riser) + 3936 (U)	45	N/A

456G-PR

RECLINATION

Roll Arm Power Swivel Glider Recliner

Standard Pillows: N/A Finish Req: N

Standard Cushions: Repose Standard Finish: N/A

COM: 7.5 yards

Features a motion control switch on the outside of the left side facing arm.

Width: 32.5 Depth: 36.5 Height: 40.75

AH: 25 SH: 20.25 SD: 21 IW: 20.5 Recl D: 66 TV Recl: 54.5 Wall Clr: 12

Weight: 123 / 123 lbs Cube: 27.97

D	E	F	G	H	J	K _{COM}	L	M	N	O	P	Q	R	S	T	U	(# above U) *	S Nail	M Nail
4050	4071	4092	4113	4134	4155	4176	4197	4218	4239	4260	4281	4302	4323	4344	4365	4386	21 (Riser) + 4386 (U)	45	N/A

456K-MR

RECLINATION

Roll Arm Manual Glider Recliner

Standard Pillows: N/A Finish Req: N

Standard Cushions: Repose Standard Finish: N/A

COM: 7.75 yards

Width: 32.5 Depth: 36.5 Height: 40.75

AH: 25 SH: 20.25 SD: 21 IW: 20.5 Recl D: 66 TV Recl: 54.5 Wall Clr: 12

Weight: 123 / 123 lbs Cube: 27.97

D	E	F	G	H	J	K _{COM}	L	M	N	O	P	Q	R	S	T	U	(# above U) *	S Nail	M Nail
3600	3621	3642	3663	3684	3705	3726	3747	3768	3789	3810	3831	3852	3873	3894	3915	3936	21 (Riser) + 3936 (U)	45	N/A

456K-PR

RECLINATION

Roll Arm Power Glider Recliner

with Power Recline

Standard Pillows: N/A Finish Req: N

Standard Cushions: Repose Standard Finish: N/A

COM: 7.75 yards

Features a motion control switch on the outside of the left side facing arm.

Width: 32.5 Depth: 36.5 Height: 40.75

AH: 25 SH: 20.25 SD: 21 IW: 20.5 Recl D: 66 TV Recl: 54.5 Wall Clr: 12

Weight: 123 / 123 lbs Cube: 27.97

D	E	F	G	H	J	K _{COM}	L	M	N	O	P	Q	R	S	T	U	(# above U) *	S Nail	M Nail
4050	4071	4092	4113	4134	4155	4176	4197	4218	4239	4260	4281	4302	4323	4344	4365	4386	21 (Riser) + 4386 (U)	45	N/A

456Z-MR

RECLINATION

Roll Arm Manual Wall Hugger Recliner

with Zero Wall Recline

Standard Pillows: N/A Finish Req: N

Standard Cushions: Repose Standard Finish: N/A

COM: 7.75 yards

Width: 32.5 Depth: 36.5 Height: 40.75

AH: 25 SH: 20.25 SD: 21 IW: 20.5 Recl D: 66 TV Recl: 54.5 Wall Clr: 3.5

Weight: 123 / 123 lbs Cube: 43.25

D	E	F	G	H	J	K _{COM}	L	M	N	O	P	Q	R	S	T	U	(# above U) *	S Nail	M Nail
3300	3321	3342	3363	3384	3405	3426	3447	3468	3489	3510	3531	3552	3573	3594	3615	3636	21 (Riser) + 3636 (U)	45	N/A

456Z-PR

RECLINATION

Roll Arm Power Wall Hugger Recliner

Standard Pillows: N/A Finish Req: N

Standard Cushions: Repose Standard Finish: N/A

COM: 7.75 yards

Features a motion control switch on the outside of the left side facing arm.

Width: 32.5 Depth: 36.5 Height: 40.75

AH: 25 SH: 20.25 SD: 21 IW: 20.5 Recl D: 66 TV Recl: 54.5 Wall Clr: 3.5

Weight: 123 / 123 lbs Cube: 27.97

D	E	F	G	H	J	K _{COM}	L	M	N	O	P	Q	R	S	T	U	(# above U) *	S Nail	M Nail
3750	3771	3792	3813	3834	3855	3876	3897	3918	3939	3960	3981	4002	4023	4044	4065	4086	21 (Riser) + 4086 (U)	45	N/A

4599-C6

BD COLLECTION FOR FAIRFIELD

Warner Counter Stool

Standard Pillows: N/A Finish Req: N

Standard Cushions: High Resiliency 40 Standard Finish: White

COM: 1.75 yards

Width: 21 Depth: 23 Height: 42.5

AH: 32 SH: 27 SD: 19 IW: 14

Weight: 24 / 24 lbs Cube: 11.87

D	E	F	G	H	J	K _{COM}	L	M	N	O	P	Q	R	S	T	U	(# above U) *	S Nail	M Nail
1350	1356	1362	1368	1374	1380	1386	1392	1398	1404	1410	1416	1422	1428	1434	1440	1446	6 (Riser) + 1446 (U)	N/A	N/A

UPHOLSTERY

4599-04

BD COLLECTION FOR FAIRFIELD
Warner Dining Chair

Standard Pillows: N/A Finish Req: N
Standard Cushions: High Resiliency 40 Standard Finish: White
COM: 1.75 yards

Width: 22.5 Depth: 23.5 Height: 36.5
AH: 25.5 SH: 19 SD: 19.5 IW: 20.5
Weight: 31 / 31 lbs Cube: 11.16

D	E	F	G	H	J	K _{COM}	L	M	N	O	P	Q	R	S	T	U	(# above U) *	S Nail	M Nail
1125	1131	1137	1143	1149	1155	1161	1167	1173	1179	1185	1191	1197	1203	1209	1215	1221	6 (Riser) + 1221 (U)	N/A	N/A

4599-06

BD COLLECTION FOR FAIRFIELD
Warner Bar Stool

Standard Pillows: N/A Finish Req: N
Standard Cushions: High Resiliency 40 Standard Finish: White
COM: 1.75 yards

Width: 21 Depth: 23 Height: 46.5
AH: 36 SH: 31 SD: 19 IW: 14
Weight: 24 / 24 lbs Cube: 12.99

D	E	F	G	H	J	K _{COM}	L	M	N	O	P	Q	R	S	T	U	(# above U) *	S Nail	M Nail
1350	1356	1362	1368	1374	1380	1386	1392	1398	1404	1410	1416	1422	1428	1434	1440	1446	6 (Riser) + 1446 (U)	N/A	N/A

4600-C6

BD COLLECTION FOR FAIRFIELD
Warner Counter Stool

Standard Pillows: N/A Finish Req: N
Standard Cushions: High Resiliency 40 Standard Finish: Black
COM: 1.75 yards

Width: 21 Depth: 23 Height: 42.5
AH: 32 SH: 27 SD: 19 IW: 14
Weight: 24 / 24 lbs Cube: 11.87

D	E	F	G	H	J	K _{COM}	L	M	N	O	P	Q	R	S	T	U	(# above U) *	S Nail	M Nail
1350	1356	1362	1368	1374	1380	1386	1392	1398	1404	1410	1416	1422	1428	1434	1440	1446	6 (Riser) + 1446 (U)	N/A	N/A

4600-04

BD COLLECTION FOR FAIRFIELD
Warner Dining Chair

Standard Pillows: N/A Finish Req: N
Standard Cushions: High Resiliency 40 Standard Finish: Black
COM: 1.75 yards

Width: 22.5 Depth: 23.5 Height: 36.5
AH: 25.5 SH: 19 SD: 19.5 IW: 20.5
Weight: 31 / 31 lbs Cube: 11.16

D	E	F	G	H	J	K _{COM}	L	M	N	O	P	Q	R	S	T	U	(# above U) *	S Nail	M Nail
1125	1131	1137	1143	1149	1155	1161	1167	1173	1179	1185	1191	1197	1203	1209	1215	1221	6 (Riser) + 1221 (U)	N/A	N/A

4600-06

BD COLLECTION FOR FAIRFIELD
Warner Bar Stool

Standard Pillows: N/A Finish Req: N
Standard Cushions: High Resiliency 40 Standard Finish: Black
COM: 1.75 yards

Width: 21 Depth: 23 Height: 46.5
AH: 36 SH: 31 SD: 19 IW: 14
Weight: 24 / 24 lbs Cube: 12.99

D	E	F	G	H	J	K _{COM}	L	M	N	O	P	Q	R	S	T	U	(# above U) *	S Nail	M Nail
1350	1356	1362	1368	1374	1380	1386	1392	1398	1404	1410	1416	1422	1428	1434	1440	1446	6 (Riser) + 1446 (U)	N/A	N/A

4601-A2

BD COLLECTION FOR FAIRFIELD
Brady Dining Chair
Two Casters

Standard Pillows: N/A Finish Req: Y
Standard Cushions: High Resiliency 40 Standard Finish: N/A
COM: 1.5 yards

Width: 24 Depth: 24.5 Height: 42.5
AH: 25 SH: 19 SD: 19.5 IW: 20
Weight: 20 / 20 lbs Cube: 14.46

D	E	F	G	H	J	K _{COM}	L	M	N	O	P	Q	R	S	T	U	(# above U) *	S Nail	M Nail
1191	1197	1203	1209	1215	1221	1227	1233	1239	1245	1251	1257	1263	1269	1275	1281	1287	6 (Riser) + 1287 (U)	45	60

4601-C6

BD COLLECTION FOR FAIRFIELD
Brady Counter Stool

Standard Pillows: N/A Finish Req: Y
Standard Cushions: High Resiliency 40 Standard Finish: N/A
COM: 1.5 yards

Width: 23.5 Depth: 23.5 Height: 43
AH: 32.5 SH: 26 SD: 20 IW: 19
Weight: 20 / 20 lbs Cube: 13.74

D	E	F	G	H	J	K _{COM}	L	M	N	O	P	Q	R	S	T	U	(# above U) *	S Nail	M Nail
1275	1281	1287	1293	1299	1305	1311	1317	1323	1329	1335	1341	1347	1353	1359	1365	1371	6 (Riser) + 1371 (U)	45	60

UPHOLSTERY

4601-04

BD COLLECTION FOR FAIRFIELD
Brady Dining Chair

Standard Pillows: N/A Finish Req: Y
Standard Cushions: High Resiliency 40 Standard Finish: N/A
COM: 1.5 yards

Width: 24 Depth: 24.5 Height: 42.5
AH: 25 SH: 19 SD: 19.5 IW: 20
Weight: 20 / 20 lbs Cube: 14.46

D	E	F	G	H	J	K COM	L	M	N	O	P	Q	R	S	T	U	(# above U) *	S Nail	M Nail
1155	1161	1167	1173	1179	1185	1191	1197	1203	1209	1215	1221	1227	1233	1239	1245	1251	6 (Riser) + 1251 (U)	45	60

4603-A2

BD COLLECTION FOR FAIRFIELD
Wren Dining Chair
with two front casters

Standard Pillows: N/A Finish Req: Y
Standard Cushions: High Resiliency 40 Standard Finish: N/A
COM: 2.5 yards

Width: 24 Depth: 27 Height: 42.25
AH: 26.5 SH: 20.5 SD: 20 IW: 20.75
Weight: 30 / 30 lbs Cube: 15.84

D	E	F	G	H	J	K COM	L	M	N	O	P	Q	R	S	T	U	(# above U) *	S Nail	M Nail
1431	1440	1449	1458	1467	1476	1485	1494	1503	1512	1521	1530	1539	1548	1557	1566	1575	9 (Riser) + 1575 (U)	N/A	N/A

4603-C6

BD COLLECTION FOR FAIRFIELD
Wren Counter Stool

Standard Pillows: N/A Finish Req: Y
Standard Cushions: High Resiliency 40 Standard Finish: N/A
COM: 2.5 yards

Width: 24 Depth: 27 Height: 46.75
AH: 33.25 SH: 26 SD: 20 IW: 20.75
Weight: 31 / 31 lbs Cube: 17.53

D	E	F	G	H	J	K COM	L	M	N	O	P	Q	R	S	T	U	(# above U) *	S Nail	M Nail
1485	1494	1503	1512	1521	1530	1539	1548	1557	1566	1575	1584	1593	1602	1611	1620	1629	9 (Riser) + 1629 (U)	N/A	N/A

4603-04

BD COLLECTION FOR FAIRFIELD
Wren Dining Chair

Standard Pillows: N/A Finish Req: Y
Standard Cushions: High Resiliency 40 Standard Finish: N/A
COM: 2.5 yards

Width: 24 Depth: 27 Height: 42.25
AH: 26.5 SH: 20.5 SD: 20 IW: 20.75
Weight: 30 / 30 lbs Cube: 15.84

D	E	F	G	H	J	K COM	L	M	N	O	P	Q	R	S	T	U	(# above U) *	S Nail	M Nail
1395	1404	1413	1422	1431	1440	1449	1458	1467	1476	1485	1494	1503	1512	1521	1530	1539	9 (Riser) + 1539 (U)	N/A	N/A

4603-06

BD COLLECTION FOR FAIRFIELD
Wren Bar Stool

Standard Pillows: N/A Finish Req: Y
Standard Cushions: High Resiliency 40 Standard Finish: N/A
COM: 2.5 yards

Width: 24 Depth: 27 Height: 50.75
AH: 37.75 SH: 30 SD: 20 IW: 20.75
Weight: 32 / 32 lbs Cube: 19.03

D	E	F	G	H	J	K COM	L	M	N	O	P	Q	R	S	T	U	(# above U) *	S Nail	M Nail
1485	1494	1503	1512	1521	1530	1539	1548	1557	1566	1575	1584	1593	1602	1611	1620	1629	9 (Riser) + 1629 (U)	N/A	N/A

4604-A2

BD COLLECTION FOR FAIRFIELD
Xander Dining Chair
Two Casters

Standard Pillows: N/A Finish Req: Y
Standard Cushions: High Resiliency 40 Standard Finish: N/A
COM: 2 yards

Width: 23.5 Depth: 24 Height: 39.5
AH: 25 SH: 19 SD: 18.5 IW: 18.5
Weight: 20 / 20 lbs Cube: 12.89

D	E	F	G	H	J	K COM	L	M	N	O	P	Q	R	S	T	U	(# above U) *	S Nail	M Nail
1281	1287	1293	1299	1305	1311	1317	1323	1329	1335	1341	1347	1353	1359	1365	1371	1377	6 (Riser) + 1377 (U)	N/A	N/A

4604-C6

BD COLLECTION FOR FAIRFIELD
Xander Counter Stool

Standard Pillows: N/A Finish Req: Y
Standard Cushions: High Resiliency 40 Standard Finish: N/A
COM: 2 yards

Width: 23.5 Depth: 24 Height: 42
AH: 30 SH: 25.5 SD: 18.5 IW: 18.5
Weight: 23 / 23 lbs Cube: 13.7

D	E	F	G	H	J	K COM	L	M	N	O	P	Q	R	S	T	U	(# above U) *	S Nail	M Nail
1350	1356	1362	1368	1374	1380	1386	1392	1398	1404	1410	1416	1422	1428	1434	1440	1446	6 (Riser) + 1446 (U)	N/A	N/A

UPHOLSTERY

4604-04

BD COLLECTION FOR FAIRFIELD
Xander Dining Chair

Standard Pillows: N/A **Finish Req:** Y
Standard Cushions: High Resiliency 40 **Standard Finish:** N/A
COM: 2 yards

Width: 23.5 **Depth:** 24 **Height:** 39.5
AH: 25 **SH:** 19 **SD:** 18.5 **IW:** 18.5
Weight: 20 / 20 lbs **Cube:** 12.89

D	E	F	G	H	J	K ^{COM}	L	M	N	O	P	Q	R	S	T	U	(# above U) *	S Nail	M Nail
1245	1251	1257	1263	1269	1275	1281	1287	1293	1299	1305	1311	1317	1323	1329	1335	1341	6 (Riser) + 1341 (U)	N/A	N/A

4605-A2

BD COLLECTION FOR FAIRFIELD
Anderson Arm Chair

Standard Pillows: N/A **Finish Req:** Y
Standard Cushions: High Resiliency 40 **Standard Finish:** N/A
COM: 3.75 yards

Width: 24.5 **Depth:** 28.5 **Height:** 39.5
AH: 25.25 **SH:** 19.5 **SD:** 19.5 **IW:** 19.5
Weight: 25 / 38 lbs **Cube:** 21.65

D	E	F	G	H	J	K ^{COM}	L	M	N	O	P	Q	R	S	T	U	(# above U) *	S Nail	M Nail
1770	1782	1794	1806	1818	1830	1842	1854	1866	1878	1890	1902	1914	1926	1938	1950	1962	12 (Riser) + 1962 (U)	N/A	N/A

4605-A2-P

BD COLLECTION FOR FAIRFIELD
Anderson Arm Chair with Pull

Standard Pillows: N/A **Finish Req:** Y
Standard Cushions: High Resiliency 40 **Standard Finish:** N/A
COM: 3.75 yards
 Features a decorative leather handle with cream accent stitching.

Width: 24.5 **Depth:** 28.5 **Height:** 39.5
AH: 25.25 **SH:** 19.5 **SD:** 19.5 **IW:** 19.5
Weight: 25 / 38 lbs **Cube:** 21.65

D	E	F	G	H	J	K ^{COM}	L	M	N	O	P	Q	R	S	T	U	(# above U) *	S Nail	M Nail
1800	1812	1824	1836	1848	1860	1872	1884	1896	1908	1920	1932	1944	1956	1968	1980	1992	12 (Riser) + 1992 (U)	N/A	N/A

4605-A4

BD COLLECTION FOR FAIRFIELD
Anderson Arm Chair

Standard Pillows: N/A **Finish Req:** Y
Standard Cushions: High Resiliency 40 **Standard Finish:** N/A
COM: 3.75 yards

Width: 24.5 **Depth:** 28.5 **Height:** 39.5
AH: 25.25 **SH:** 19.5 **SD:** 19.5 **IW:** 19.5
Weight: 25 / 38 lbs **Cube:** 21.65

D	E	F	G	H	J	K ^{COM}	L	M	N	O	P	Q	R	S	T	U	(# above U) *	S Nail	M Nail
1806	1818	1830	1842	1854	1866	1878	1890	1902	1914	1926	1938	1950	1962	1974	1986	1998	12 (Riser) + 1998 (U)	N/A	N/A

4605-A4-P

BD COLLECTION FOR FAIRFIELD
Anderson Arm Chair with Pull

Standard Pillows: N/A **Finish Req:** Y
Standard Cushions: High Resiliency 40 **Standard Finish:** N/A
COM: 3.75 yards
 Features a decorative leather handle with cream accent stitching.

Width: 24.5 **Depth:** 28.5 **Height:** 39.5
AH: 25.25 **SH:** 19.5 **SD:** 19.5 **IW:** 19.5
Weight: 25 / 38 lbs **Cube:** 21.65

D	E	F	G	H	J	K ^{COM}	L	M	N	O	P	Q	R	S	T	U	(# above U) *	S Nail	M Nail
1836	1848	1860	1872	1884	1896	1908	1920	1932	1944	1956	1968	1980	1992	2004	2016	2028	12 (Riser) + 2028 (U)	N/A	N/A

4605-C6

BD COLLECTION FOR FAIRFIELD
Anderson Arm Counter Stool

Standard Pillows: N/A **Finish Req:** Y
Standard Cushions: High Resiliency 40 **Standard Finish:** N/A
COM: 3.75 yards

Width: 24.5 **Depth:** 26 **Height:** 40
AH: 32 **SH:** 27 **SD:** 19.5 **IW:** 19.5
Weight: 29 / 39 lbs **Cube:** 21.65

D	E	F	G	H	J	K ^{COM}	L	M	N	O	P	Q	R	S	T	U	(# above U) *	S Nail	M Nail
1764	1776	1788	1800	1812	1824	1836	1848	1860	1872	1884	1896	1908	1920	1932	1944	1956	12 (Riser) + 1956 (U)	N/A	N/A

4605-C6-P

BD COLLECTION FOR FAIRFIELD
Anderson Arm Counter Stool

Standard Pillows: N/A **Finish Req:** Y
Standard Cushions: High Resiliency 40 **Standard Finish:** N/A
COM: 3.75 yards
 Features a decorative leather handle with cream accent stitching.

Width: 24.5 **Depth:** 26 **Height:** 40
AH: 32 **SH:** 27 **SD:** 19.5 **IW:** 19.5
Weight: 29 / 40 lbs **Cube:** 17.77

D	E	F	G	H	J	K ^{COM}	L	M	N	O	P	Q	R	S	T	U	(# above U) *	S Nail	M Nail
1794	1806	1818	1830	1842	1854	1866	1878	1890	1902	1914	1926	1938	1950	1962	1974	1986	12 (Riser) + 1986 (U)	N/A	N/A

UPHOLSTERY

4605-04

BD COLLECTION FOR FAIRFIELD
Anderson Arm Chair

Standard Pillows: N/A Finish Req: Y
Standard Cushions: High Resiliency 40 Standard Finish: N/A
COM: 3.75 yards

Width: 24.5 Depth: 28.5 Height: 39.5
AH: 25.25 SH: 19.5 SD: 19.5 IW: 19.5
Weight: 25 / 35 lbs Cube: 21.65

D	E	F	G	H	J	K _{COM}	L	M	N	O	P	Q	R	S	T	U	(# above U) *	S Nail	M Nail
1734	1746	1758	1770	1782	1794	1806	1818	1830	1842	1854	1866	1878	1890	1902	1914	1926	12 (Riser) + 1926 (U)	N/A	N/A

4605-04-P

BD COLLECTION FOR FAIRFIELD
Anderson Arm Chair with Pull

Standard Pillows: N/A Finish Req: Y
Standard Cushions: High Resiliency 40 Standard Finish: N/A
COM: 3.75 yards
Features a decorative leather handle with cream accent stitching.

Width: 24.5 Depth: 28.5 Height: 39.5
AH: 25.25 SH: 19.5 SD: 19.5 IW: 19.5
Weight: 25 / 38 lbs Cube: 21.65

D	E	F	G	H	J	K _{COM}	L	M	N	O	P	Q	R	S	T	U	(# above U) *	S Nail	M Nail
1764	1776	1788	1800	1812	1824	1836	1848	1860	1872	1884	1896	1908	1920	1932	1944	1956	12 (Riser) + 1956 (U)	N/A	N/A

4605-06

BD COLLECTION FOR FAIRFIELD
Anderson Arm Bar Stool

Standard Pillows: N/A Finish Req: Y
Standard Cushions: High Resiliency 40 Standard Finish: N/A
COM: 3.75 yards

Width: 24.5 Depth: 26 Height: 44
AH: 36 SH: 31 SD: 19.5 IW: 19.5
Weight: 30 / 40 lbs Cube: 24.14

D	E	F	G	H	J	K _{COM}	L	M	N	O	P	Q	R	S	T	U	(# above U) *	S Nail	M Nail
1764	1776	1788	1800	1812	1824	1836	1848	1860	1872	1884	1896	1908	1920	1932	1944	1956	12 (Riser) + 1956 (U)	N/A	N/A

4605-06-P

BD COLLECTION FOR FAIRFIELD
Anderson Arm Bar Stool with Pull

Standard Pillows: N/A Finish Req: Y
Standard Cushions: High Resiliency 40 Standard Finish: N/A
COM: 3.75 yards
Features a decorative leather handle with cream accent stitching.

Width: 24.5 Depth: 26 Height: 44
AH: 36 SH: 31 SD: 19.5 IW: 19.5
Weight: 30 / 43 lbs Cube: 19.6

D	E	F	G	H	J	K _{COM}	L	M	N	O	P	Q	R	S	T	U	(# above U) *	S Nail	M Nail
1794	1806	1818	1830	1842	1854	1866	1878	1890	1902	1914	1926	1938	1950	1962	1974	1986	12 (Riser) + 1986 (U)	N/A	N/A

4606-A2

BD COLLECTION FOR FAIRFIELD
Gigi Arm Chair

Standard Pillows: N/A Finish Req: Y
Standard Cushions: High Resiliency 40 Standard Finish: N/A
COM: 3.5 yards

Width: 27.5 Depth: 25 Height: 33.5
AH: 25.5 SH: 18.5 SD: 18.5 IW: 20.25
Weight: 27 / 40 lbs Cube: 21.65

D	E	F	G	H	J	K _{COM}	L	M	N	O	P	Q	R	S	T	U	(# above U) *	S Nail	M Nail
2196	2208	2220	2232	2244	2256	2268	2280	2292	2304	2316	2328	2340	2352	2364	2376	2388	12 (Riser) + 2388 (U)	N/A	N/A

4606-A4

BD COLLECTION FOR FAIRFIELD
Gigi Arm Chair

Standard Pillows: N/A Finish Req: Y
Standard Cushions: High Resiliency 40 Standard Finish: N/A
COM: 3.5 yards

Width: 27.5 Depth: 25 Height: 33.5
AH: 25.5 SH: 18.5 SD: 18.5 IW: 20.25
Weight: 27 / 40 lbs Cube: 21.65

D	E	F	G	H	J	K _{COM}	L	M	N	O	P	Q	R	S	T	U	(# above U) *	S Nail	M Nail
2232	2244	2256	2268	2280	2292	2304	2316	2328	2340	2352	2364	2376	2388	2400	2412	2424	12 (Riser) + 2424 (U)	N/A	N/A

4606-C6

BD COLLECTION FOR FAIRFIELD
Gigi Arm Counter Stool

Standard Pillows: N/A Finish Req: Y
Standard Cushions: High Resiliency 40 Standard Finish: N/A
COM: 3.5 yards

Width: 27.5 Depth: 25 Height: 40
AH: 32 SH: 25 SD: 18.5 IW: 20.25
Weight: 30 / 43 lbs Cube: 21.65

D	E	F	G	H	J	K _{COM}	L	M	N	O	P	Q	R	S	T	U	(# above U) *	S Nail	M Nail
2160	2172	2184	2196	2208	2220	2232	2244	2256	2268	2280	2292	2304	2316	2328	2340	2352	12 (Riser) + 2352 (U)	N/A	N/A

UPHOLSTERY

4606-04

BD COLLECTION FOR FAIRFIELD
Gigi Arm Chair

Standard Pillows: N/A Finish Req: Y
Standard Cushions: High Resiliency 40 Standard Finish: N/A
COM: 3.5 yards

Width: 27.5 Depth: 25 Height: 33.5
AH: 25.5 SH: 18.5 SD: 18.5 IW: 20.25
Weight: 27 / 40 lbs Cube: 21.65

D	E	F	G	H	J	K _{COM}	L	M	N	O	P	Q	R	S	T	U	(# above U) *	S Nail	M Nail
2160	2172	2184	2196	2208	2220	2232	2244	2256	2268	2280	2292	2304	2316	2328	2340	2352	12 (Riser) + 2352 (U)	N/A	N/A

4606-06

BD COLLECTION FOR FAIRFIELD
Gigi Arm Bar Stool

Standard Pillows: N/A Finish Req: Y
Standard Cushions: High Resiliency 40 Standard Finish: N/A
COM: 3.5 yards

Width: 27.5 Depth: 25 Height: 44
AH: 36 SH: 29 SD: 18.5 IW: 20.25
Weight: 31 / 41 lbs Cube: 25.19

D	E	F	G	H	J	K _{COM}	L	M	N	O	P	Q	R	S	T	U	(# above U) *	S Nail	M Nail
2160	2172	2184	2196	2208	2220	2232	2244	2256	2268	2280	2292	2304	2316	2328	2340	2352	12 (Riser) + 2352 (U)	N/A	N/A

4608-A2

BD COLLECTION FOR FAIRFIELD
Gerheart Dining Chair
Two Casters

Standard Pillows: N/A Finish Req: Y
Standard Cushions: High Resiliency 40 Standard Finish: N/A
COM: 2.25 yards

Width: 24 Depth: 24.5 Height: 38
AH: 25.5 SH: 20 SD: 20 IW: 18
Weight: 23 / 23 lbs Cube: 12.93

D	E	F	G	H	J	K _{COM}	L	M	N	O	P	Q	R	S	T	U	(# above U) *	S Nail	M Nail
1236	1242	1248	1254	1260	1266	1272	1278	1284	1290	1296	1302	1308	1314	1320	1326	1332	6 (Riser) + 1332 (U)	45	N/A

4608-A4

BD COLLECTION FOR FAIRFIELD
Gerheart Dining Chair
Four Casters

Standard Pillows: N/A Finish Req: Y
Standard Cushions: High Resiliency 40 Standard Finish: N/A
COM: 2.25 yards

Width: 24 Depth: 24.5 Height: 38
AH: 25.5 SH: 20 SD: 20 IW: 18
Weight: 23 / 23 lbs Cube: 12.93

D	E	F	G	H	J	K _{COM}	L	M	N	O	P	Q	R	S	T	U	(# above U) *	S Nail	M Nail
1272	1278	1284	1290	1296	1302	1308	1314	1320	1326	1332	1338	1344	1350	1356	1362	1368	6 (Riser) + 1368 (U)	45	N/A

4608-C6

BD COLLECTION FOR FAIRFIELD
Gerheart Counter Stool

Standard Pillows: N/A Finish Req: Y
Standard Cushions: High Resiliency 40 Standard Finish: N/A
COM: 2.25 yards

Width: 21 Depth: 23.5 Height: 42.5
AH: 32 SH: 27 SD: 19 IW: 14
Weight: 24 / 24 lbs Cube: 12.13

D	E	F	G	H	J	K _{COM}	L	M	N	O	P	Q	R	S	T	U	(# above U) *	S Nail	M Nail
1275	1281	1287	1293	1299	1305	1311	1317	1323	1329	1335	1341	1347	1353	1359	1365	1371	6 (Riser) + 1371 (U)	45	N/A

4608-04

BD COLLECTION FOR FAIRFIELD
Gerheart Dining Chair

Standard Pillows: N/A Finish Req: Y
Standard Cushions: High Resiliency 40 Standard Finish: N/A
COM: 2.25 yards

Width: 24 Depth: 24.5 Height: 38
AH: 25.5 SH: 20 SD: 20 IW: 18
Weight: 23 / 23 lbs Cube: 12.93

D	E	F	G	H	J	K _{COM}	L	M	N	O	P	Q	R	S	T	U	(# above U) *	S Nail	M Nail
1200	1206	1212	1218	1224	1230	1236	1242	1248	1254	1260	1266	1272	1278	1284	1290	1296	6 (Riser) + 1296 (U)	45	N/A

4615-A4

BD COLLECTION FOR FAIRFIELD
Anderson Arm Chair with Half Skirt

Standard Pillows: N/A Finish Req: Y
Standard Cushions: High Resiliency 40 Standard Finish: N/A
COM: 4.5 yards

Width: 24.5 Depth: 28.5 Height: 39.5
AH: 25.25 SH: 19.5 SD: 19.5 IW: 19.5
Weight: 25 / 38 lbs Cube: 21.65

D	E	F	G	H	J	K _{COM}	L	M	N	O	P	Q	R	S	T	U	(# above U) *	S Nail	M Nail
1962	1977	1992	2007	2022	2037	2052	2067	2082	2097	2112	2127	2142	2157	2172	2187	2202	15 (Riser) + 2202 (U)	N/A	N/A

UPHOLSTERY

4615-A4-P

BD COLLECTION FOR FAIRFIELD
Anderson Arm Chair with Half Skirt and Pull

Standard Pillows: N/A **Finish Req:** Y
Standard Cushions: High Resilency 40 **Standard Finish:** N/A
COM: 4.5 yards
 Features a decorative leather handle with cream accent stitching.

Width: 24.5 **Depth:** 28.5 **Height:** 39.5
AH: 25.25 **SH:** 19.5 **SD:** 19.5 **IW:** 19.5
Weight: 25 / 38 lbs **Cube:** 21.65

D	E	F	G	H	J	K COM	L	M	N	O	P	Q	R	S	T	U	(# above U) *	S Nail	M Nail
1992	2007	2022	2037	2052	2067	2082	2097	2112	2127	2142	2157	2172	2187	2202	2217	2232	15 (Riser) + 2232 (U)	N/A	N/A

4615-04

BD COLLECTION FOR FAIRFIELD
Anderson Arm Chair with Half Skirt

Standard Pillows: N/A **Finish Req:** Y
Standard Cushions: High Resilency 40 **Standard Finish:** N/A
COM: 4.5 yards

Width: 24.5 **Depth:** 28.5 **Height:** 39.5
AH: 25.25 **SH:** 19.5 **SD:** 19.5 **IW:** 19.5
Weight: 25 / 35 lbs **Cube:** 21.65

D	E	F	G	H	J	K COM	L	M	N	O	P	Q	R	S	T	U	(# above U) *	S Nail	M Nail
1890	1905	1920	1935	1950	1965	1980	1995	2010	2025	2040	2055	2070	2085	2100	2115	2130	15 (Riser) + 2130 (U)	N/A	N/A

4615-04-P

BD COLLECTION FOR FAIRFIELD
Anderson Arm Chair with Half Skirt and Pull

Standard Pillows: N/A **Finish Req:** Y
Standard Cushions: High Resilency 40 **Standard Finish:** N/A
COM: 4.5 yards
 Features a decorative leather handle with cream accent stitching.

Width: 24.5 **Depth:** 28.5 **Height:** 39.5
AH: 25.25 **SH:** 19.5 **SD:** 19.5 **IW:** 19.5
Weight: 25 / 38 lbs **Cube:** 21.65

D	E	F	G	H	J	K COM	L	M	N	O	P	Q	R	S	T	U	(# above U) *	S Nail	M Nail
1920	1935	1950	1965	1980	1995	2010	2025	2040	2055	2070	2085	2100	2115	2130	2145	2160	15 (Riser) + 2160 (U)	N/A	N/A

4616-A4

BD COLLECTION FOR FAIRFIELD
Gigi Arm Chair with Half Skirt

Standard Pillows: N/A **Finish Req:** Y
Standard Cushions: High Resilency 40 **Standard Finish:** N/A
COM: 4 yards

Width: 27.5 **Depth:** 25 **Height:** 33.5
AH: 25.5 **SH:** 18.5 **SD:** 18.5 **IW:** 20.25
Weight: 27 / 40 lbs **Cube:** 21.65

D	E	F	G	H	J	K COM	L	M	N	O	P	Q	R	S	T	U	(# above U) *	S Nail	M Nail
2352	2364	2376	2388	2400	2412	2424	2436	2448	2460	2472	2484	2496	2508	2520	2532	2544	12 (Riser) + 2544 (U)	N/A	N/A

4616-04

BD COLLECTION FOR FAIRFIELD
Gigi Arm Chair with Half Skirt

Standard Pillows: N/A **Finish Req:** Y
Standard Cushions: High Resilency 40 **Standard Finish:** N/A
COM: 4 yards

Width: 27.5 **Depth:** 25 **Height:** 33.5
AH: 25.5 **SH:** 18.5 **SD:** 18.5 **IW:** 20.25
Weight: 27 / 37 lbs **Cube:** 21.65

D	E	F	G	H	J	K COM	L	M	N	O	P	Q	R	S	T	U	(# above U) *	S Nail	M Nail
2280	2292	2304	2316	2328	2340	2352	2364	2376	2388	2400	2412	2424	2436	2448	2460	2472	12 (Riser) + 2472 (U)	N/A	N/A

462C-MR

RECLINATION
Loft Manual Push Back Recliner

Standard Pillows: N/A **Finish Req:** Y
Standard Cushions: Repose **Standard Finish:** N/A
COM: 7 yards

Width: 29.5 **Depth:** 35 **Height:** 41.5
AH: 24 **SH:** 21.25 **SD:** 21 **IW:** 21.25 **Recl D:** 65 **TV Recl:** 56 **Wall Clr:** 12
Weight: 95 / 116 lbs **Cube:** 34.38

D	E	F	G	H	J	K COM	L	M	N	O	P	Q	R	S	T	U	(# above U) *	S Nail	M Nail
3300	3321	3342	3363	3384	3405	3426	3447	3468	3489	3510	3531	3552	3573	3594	3615	3636	21 (Riser) + 3636 (U)	N/A	N/A

462C-PR

RECLINATION
Loft Power Recliner
 with Power Recline

Standard Pillows: N/A **Finish Req:** Y
Standard Cushions: Repose **Standard Finish:** N/A
COM: 7 yards
 Features a motion control switch on the outside of the left side facing arm.

Width: 29.5 **Depth:** 35 **Height:** 41.5
AH: 24 **SH:** 21.25 **SD:** 21 **IW:** 21.25 **Recl D:** 65 **TV Recl:** 56 **Wall Clr:** 12
Weight: 95 / 95 lbs **Cube:** 34.38

D	E	F	G	H	J	K COM	L	M	N	O	P	Q	R	S	T	U	(# above U) *	S Nail	M Nail
3750	3771	3792	3813	3834	3855	3876	3897	3918	3939	3960	3981	4002	4023	4044	4065	4086	21 (Riser) + 4086 (U)	N/A	N/A

UPHOLSTERY

462P-MR-1

RECLINATION

Loft Manual Swivel Recliner

with Bronze Five Prong Base

Width: 29.5 Depth: 35 Height: 41.5

AH: 24 SH: 21.25 SD: 21 IW: 21.25 Recl D: 65 TV Recl: 56 Wall Clr: 12

Weight: 95 / 95 lbs Cube: 34.38

Standard Pillows: N/A Finish Req: Y

Standard Cushions: Repose Standard Finish: N/A

COM: 6.75 yards

Metal Prong Base in Bronze

D	E	F	G	H	J	K _{COM}	L	M	N	O	P	Q	R	S	T	U	(# above U) *	S Nail	M Nail
3675	3693	3711	3729	3747	3765	3783	3801	3819	3837	3855	3873	3891	3909	3927	3945	3963	18 (Riser) + 3963 (U)	N/A	N/A

462P-MR-2

RECLINATION

Loft Manual Swivel Recliner

with Brushed Nickel Five Prong Base

Width: 29.5 Depth: 35 Height: 41.5

AH: 24 SH: 21.25 SD: 21 IW: 21.25 Recl D: 65 TV Recl: 56 Wall Clr: 12

Weight: 95 / 95 lbs Cube: 24.79

Standard Pillows: N/A Finish Req: Y

Standard Cushions: Repose Standard Finish: N/A

COM: 6.75 yards

Metal Prong Base in Brushed Nickel

D	E	F	G	H	J	K _{COM}	L	M	N	O	P	Q	R	S	T	U	(# above U) *	S Nail	M Nail
3675	3693	3711	3729	3747	3765	3783	3801	3819	3837	3855	3873	3891	3909	3927	3945	3963	18 (Riser) + 3963 (U)	N/A	N/A

462P-MR-7

RECLINATION

Loft Manual Swivel Recliner

with Bright Brass Five Prong Base

Width: 29.5 Depth: 35 Height: 41.5

AH: 24 SH: 21.25 SD: 21 IW: 21.25 Recl D: 65 TV Recl: 56 Wall Clr: 12

Weight: 95 / 95 lbs Cube: 24.79

Standard Pillows: N/A Finish Req: Y

Standard Cushions: Repose Standard Finish: N/A

COM: 6.75 yards

Metal Prong Base in Bright Brass

D	E	F	G	H	J	K _{COM}	L	M	N	O	P	Q	R	S	T	U	(# above U) *	S Nail	M Nail
3675	3693	3711	3729	3747	3765	3783	3801	3819	3837	3855	3873	3891	3909	3927	3945	3963	18 (Riser) + 3963 (U)	N/A	N/A

462P-PR-1

RECLINATION

Loft Power Swivel Recliner

with Bronze Five Prong Base

Width: 29.5 Depth: 35 Height: 41.5

AH: 24 SH: 21.25 SD: 21 IW: 21.25 Recl D: 65 TV Recl: 56 Wall Clr: 12

Weight: 95 / 95 lbs Cube: 34.38

Standard Pillows: N/A Finish Req: Y

Standard Cushions: Repose Standard Finish: N/A

COM: 6.75 yards

Metal Prong Base in Bronze

D	E	F	G	H	J	K _{COM}	L	M	N	O	P	Q	R	S	T	U	(# above U) *	S Nail	M Nail
4125	4143	4161	4179	4197	4215	4233	4251	4269	4287	4305	4323	4341	4359	4377	4395	4413	18 (Riser) + 4413 (U)	N/A	N/A

462P-PR-2

RECLINATION

Loft Power Swivel Recliner

with Brushed Nickel Five Prong Base

Width: 29.5 Depth: 35 Height: 41.5

AH: 24 SH: 21.25 SD: 21 IW: 21.25 Recl D: 65 TV Recl: 56 Wall Clr: 12

Weight: 95 / 95 lbs Cube: 34.38

Standard Pillows: N/A Finish Req: Y

Standard Cushions: Repose Standard Finish: N/A

COM: 6.75 yards

Metal Prong Base in Brushed Nickel

D	E	F	G	H	J	K _{COM}	L	M	N	O	P	Q	R	S	T	U	(# above U) *	S Nail	M Nail
4125	4143	4161	4179	4197	4215	4233	4251	4269	4287	4305	4323	4341	4359	4377	4395	4413	18 (Riser) + 4413 (U)	N/A	N/A

462P-PR-7

RECLINATION

Loft Power Swivel Recliner

with Bright Brass Five Prong Base

Width: 29.5 Depth: 35 Height: 41.5

AH: 24 SH: 21.25 SD: 21 IW: 21.25 Recl D: 65 TV Recl: 56 Wall Clr: 12

Weight: 95 / 95 lbs Cube: 34.38

Standard Pillows: N/A Finish Req: Y

Standard Cushions: Repose Standard Finish: N/A

COM: 6.75 yards

Metal Prong Base in Bright Brass

D	E	F	G	H	J	K _{COM}	L	M	N	O	P	Q	R	S	T	U	(# above U) *	S Nail	M Nail
4125	4143	4161	4179	4197	4215	4233	4251	4269	4287	4305	4323	4341	4359	4377	4395	4413	18 (Riser) + 4413 (U)	N/A	N/A

4625-A4

BD COLLECTION FOR FAIRFIELD

Anderson Arm Chair with Full Skirt

Width: 24.5 Depth: 28.5 Height: 39.5

AH: 25.25 SH: 19.5 SD: 19.5 IW: 19.5

Weight: 25 / 38 lbs Cube: 21.65

Standard Pillows: N/A Finish Req: Y

Standard Cushions: High Resiliency 40 Standard Finish: N/A

COM: 5.25 yards

D	E	F	G	H	J	K _{COM}	L	M	N	O	P	Q	R	S	T	U	(# above U) *	S Nail	M Nail
2037	2058	2079	2100	2121	2142	2163	2184	2205	2226	2247	2268	2289	2310	2331	2352	2373	21 (Riser) + 2373 (U)	N/A	N/A

UPHOLSTERY

4625-A4-P

BD COLLECTION FOR FAIRFIELD

Anderson Arm Chair with Full Skirt and Pull

Standard Pillows: N/A Finish Req: Y

Standard Cushions: High Resiliency 40 Standard Finish: N/A

COM: 5.25 yards

Features a decorative leather handle with cream accent stitching.

Width: 24.5 Depth: 28.5 Height: 39.5

AH: 25.25 SH: 19.5 SD: 19.5 IW: 19.5

Weight: 25 / 38 lbs Cube: 21.65

D	E	F	G	H	J	K _{COM}	L	M	N	O	P	Q	R	S	T	U	(# above U) *	S Nail	M Nail
2067	2088	2109	2130	2151	2172	2193	2214	2235	2256	2277	2298	2319	2340	2361	2382	2403	21 (Riser) + 2403 (U)	N/A	N/A

4625-04

BD COLLECTION FOR FAIRFIELD

Anderson Arm Chair with Full Skirt

Standard Pillows: N/A Finish Req: Y

Standard Cushions: High Resiliency 40 Standard Finish: N/A

COM: 5.25 yards

Width: 24.5 Depth: 28.5 Height: 39.5

AH: 25.25 SH: 19.5 SD: 19.5 IW: 19.5

Weight: 25 / 38 lbs Cube: 21.65

D	E	F	G	H	J	K _{COM}	L	M	N	O	P	Q	R	S	T	U	(# above U) *	S Nail	M Nail
1965	1986	2007	2028	2049	2070	2091	2112	2133	2154	2175	2196	2217	2238	2259	2280	2301	21 (Riser) + 2301 (U)	N/A	N/A

4625-04-P

BD COLLECTION FOR FAIRFIELD

Anderson Arm Chair with Full Skirt and Pull

Standard Pillows: N/A Finish Req: Y

Standard Cushions: High Resiliency 40 Standard Finish: N/A

COM: 5.25 yards

Features a decorative leather handle with cream accent stitching.

Width: 24.5 Depth: 28.5 Height: 39.5

AH: 25.25 SH: 19.5 SD: 19.5 IW: 19.5

Weight: 25 / 38 lbs Cube: 21.65

D	E	F	G	H	J	K _{COM}	L	M	N	O	P	Q	R	S	T	U	(# above U) *	S Nail	M Nail
1995	2016	2037	2058	2079	2100	2121	2142	2163	2184	2205	2226	2247	2268	2289	2310	2331	21 (Riser) + 2331 (U)	N/A	N/A

4626-A4

BD COLLECTION FOR FAIRFIELD

Gigi Arm Chair with Full Skirt

Standard Pillows: N/A Finish Req: Y

Standard Cushions: High Resiliency 40 Standard Finish: N/A

COM: 4.5 yards

Width: 27.5 Depth: 25 Height: 33.5

AH: 25.5 SH: 18.5 SD: 18.5 IW: 20.25

Weight: 27 / 40 lbs Cube: 21.65

D	E	F	G	H	J	K _{COM}	L	M	N	O	P	Q	R	S	T	U	(# above U) *	S Nail	M Nail
2442	2457	2472	2487	2502	2517	2532	2547	2562	2577	2592	2607	2622	2637	2652	2667	2682	15 (Riser) + 2682 (U)	N/A	N/A

4626-04

BD COLLECTION FOR FAIRFIELD

Gigi Arm Chair with Full Skirt

Standard Pillows: N/A Finish Req: Y

Standard Cushions: High Resiliency 40 Standard Finish: N/A

COM: 4.5 yards

Width: 27.5 Depth: 25 Height: 33.5

AH: 25.5 SH: 18.5 SD: 18.5 IW: 20.25

Weight: 27 / 37 lbs Cube: 21.65

D	E	F	G	H	J	K _{COM}	L	M	N	O	P	Q	R	S	T	U	(# above U) *	S Nail	M Nail
2370	2385	2400	2415	2430	2445	2460	2475	2490	2505	2520	2535	2550	2565	2580	2595	2610	15 (Riser) + 2610 (U)	N/A	N/A

464C-MR

RECLINATION

Aspire Manual Push Back Recliner

Standard Pillows: N/A Finish Req: Y

Standard Cushions: Repose Standard Finish: N/A

COM: 8 yards

Width: 29.5 Depth: 33.25 Height: 42

AH: 22.5 SH: 21.5 SD: 19.5 IW: 22 Recl D: 62.5 TV Recl: 54 Wall Clr: 12

Weight: 95 / 95 lbs Cube: 23.84

D	E	F	G	H	J	K _{COM}	L	M	N	O	P	Q	R	S	T	U	(# above U) *	S Nail	M Nail
3600	3624	3648	3672	3696	3720	3744	3768	3792	3816	3840	3864	3888	3912	3936	3960	3984	24 (Riser) + 3984 (U)	N/A	N/A

464P-MR-1

RECLINATION

Aspire Manual Swivel Recliner

with Bronze Five Prong Base

Standard Pillows: N/A Finish Req: N

Standard Cushions: Repose Standard Finish: Bronze

COM: 7.25 yards

Metal Prong Base in Bronze

Width: 29.5 Depth: 33.25 Height: 42

AH: 22.5 SH: 21.5 SD: 19.5 IW: 22 Recl D: 62.5 TV Recl: 54 Wall Clr: 12

Weight: 95 / 95 lbs Cube: 23.84

D	E	F	G	H	J	K _{COM}	L	M	N	O	P	Q	R	S	T	U	(# above U) *	S Nail	M Nail
3675	3699	3723	3747	3771	3795	3819	3843	3867	3891	3915	3939	3963	3987	4011	4035	4059	24 (Riser) + 4059 (U)	N/A	N/A

UPHOLSTERY

464P-MR-2

RECLINATION

Aspire Manual Swivel Recliner

with Brushed Nickel Five Prong Base

Width: 29.5 Depth: 33.25 Height: 42

AH: 22.5 SH: 21.5 SD: 19.5 IW: 22 Recl D: 62.5 TV Recl: 54 Wall Clr: 12

Weight: 95 / 111 lbs Cube: 34.38

Standard Pillows: N/A Finish Req: N

Standard Cushions: Repose Standard Finish: BRUSHED NICKEL

COM: 7.25 yards

Metal Prong Base in Brushed Nickel

D	E	F	G	H	J	K _{COM}	L	M	N	O	P	Q	R	S	T	U	(# above U) *	S Nail	M Nail
3675	3699	3723	3747	3771	3795	3819	3843	3867	3891	3915	3939	3963	3987	4011	4035	4059	24 (Riser) + 4059 (U)	N/A	N/A

464P-PR-1

RECLINATION

Aspire Power Swivel Recliner

with Bronze Five Prong Base

Width: 29.5 Depth: 33.25 Height: 42

AH: 22.5 SH: 21.5 SD: 19.5 IW: 22 Recl D: 62.5 TV Recl: 54 Wall Clr: 12

Weight: 95 / 111 lbs Cube: 34.38

Standard Pillows: N/A Finish Req: N

Standard Cushions: Repose Standard Finish: Bronze

COM: 7.25 yards

Metal Prong Base in Bronze

D	E	F	G	H	J	K _{COM}	L	M	N	O	P	Q	R	S	T	U	(# above U) *	S Nail	M Nail
4125	4149	4173	4197	4221	4245	4269	4293	4317	4341	4365	4389	4413	4437	4461	4485	4509	24 (Riser) + 4509 (U)	N/A	N/A

464P-PR-2

RECLINATION

Aspire Power Swivel Recliner

with Brushed Nickel Five Prong Base

Width: 29.5 Depth: 33.25 Height: 42

AH: 22.5 SH: 21.5 SD: 19.5 IW: 22 Recl D: 62.5 TV Recl: 54 Wall Clr: 12

Weight: 95 / 95 lbs Cube: 23.84

Standard Pillows: N/A Finish Req: N

Standard Cushions: Repose Standard Finish: BRUSHED NICKEL

COM: 7.25 yards

Metal Prong Base in Brushed Nickel

D	E	F	G	H	J	K _{COM}	L	M	N	O	P	Q	R	S	T	U	(# above U) *	S Nail	M Nail
4125	4149	4173	4197	4221	4245	4269	4293	4317	4341	4365	4389	4413	4437	4461	4485	4509	24 (Riser) + 4509 (U)	N/A	N/A

465C-MR

RECLINATION

Margo Manual Push Back Recliner

Width: 31.5 Depth: 33.25 Height: 39.75

AH: 23.75 SH: 20.75 SD: 18 IW: 22 Recl D: 67 TV Recl: 57 Wall Clr: 12

Weight: 99 / 99 lbs Cube: 24.09

Standard Pillows: N/A Finish Req: Y

Standard Cushions: Repose Standard Finish: N/A

COM: 7.25 yards

D	E	F	G	H	J	K _{COM}	L	M	N	O	P	Q	R	S	T	U	(# above U) *	S Nail	M Nail
3600	3624	3648	3672	3696	3720	3744	3768	3792	3816	3840	3864	3888	3912	3936	3960	3984	24 (Riser) + 3984 (U)	N/A	N/A

465C-PR

RECLINATION

Margo Power Recliner

with Power Recline

Width: 31.5 Depth: 33.25 Height: 39.75

AH: 23.75 SH: 20.75 SD: 18 IW: 22 Recl D: 67 TV Recl: 57 Wall Clr: 12

Weight: 99 / 99 lbs Cube: 24.09

Standard Pillows: N/A Finish Req: Y

Standard Cushions: Repose Standard Finish: N/A

COM: 7.25 yards

D	E	F	G	H	J	K _{COM}	L	M	N	O	P	Q	R	S	T	U	(# above U) *	S Nail	M Nail
4050	4074	4098	4122	4146	4170	4194	4218	4242	4266	4290	4314	4338	4362	4386	4410	4434	24 (Riser) + 4434 (U)	N/A	N/A

465P-MR-1

RECLINATION

Margo Manual Swivel Recliner

with Bronze Five Prong Base

Width: 31.5 Depth: 33.25 Height: 39.75

AH: 23.75 SH: 20.75 SD: 18 IW: 22 Recl D: 67 TV Recl: 57 Wall Clr: 12

Weight: 99 / 99 lbs Cube: 24.09

Standard Pillows: N/A Finish Req: N

Standard Cushions: Repose Standard Finish: Bronze

COM: 7.25 yards

Metal Prong Base in Bronze

D	E	F	G	H	J	K _{COM}	L	M	N	O	P	Q	R	S	T	U	(# above U) *	S Nail	M Nail
3750	3774	3798	3822	3846	3870	3894	3918	3942	3966	3990	4014	4038	4062	4086	4110	4134	24 (Riser) + 4134 (U)	N/A	N/A

465P-MR-2

RECLINATION

Margo Manual Swivel Recliner

with Brushed Nickel Five Prong Base

Width: 31.5 Depth: 33.25 Height: 39.75

AH: 23.75 SH: 20.75 SD: 18 IW: 22 Recl D: 67 TV Recl: 57 Wall Clr: 12

Weight: 99 / 99 lbs Cube: 24.09

Standard Pillows: N/A Finish Req: N

Standard Cushions: Repose Standard Finish: BRUSHED NICKEL

COM: 7.25 yards

Metal Prong Base in Brushed Nickel

D	E	F	G	H	J	K _{COM}	L	M	N	O	P	Q	R	S	T	U	(# above U) *	S Nail	M Nail
3750	3774	3798	3822	3846	3870	3894	3918	3942	3966	3990	4014	4038	4062	4086	4110	4134	24 (Riser) + 4134 (U)	N/A	N/A

UPHOLSTERY

465P-PR-2

RECLINATION

Margo Power Swivel Recliner

with Brushed Nickel Five Prong Base

Width: 31.5 Depth: 33.25 Height: 39.75

AH: 23.75 SH: 20.75 SD: 18 IW: 22 Recl D: 67 TV Recl: 57 Wall Clr: 12

Weight: 99 / 99 lbs Cube: 24.09

Standard Pillows: N/A Finish Req: N

Standard Cushions: Repose Standard Finish: BRUSHED NICKEL

COM: 7.25 yards

Metal Prong Base in Brushed Nickel

D	E	F	G	H	J	K _{COM}	L	M	N	O	P	Q	R	S	T	U	(# above U) *	S Nail	M Nail
4200	4224	4248	4272	4296	4320	4344	4368	4392	4416	4440	4464	4488	4512	4536	4560	4584	24 (Riser) + 4584 (U)	N/A	N/A

466C-MR

RECLINATION

Wyndham Manual Push Back Recliner

Width: 28.25 Depth: 33.75 Height: 41

AH: 26 SH: 18.5 SD: 22 IW: 24 Recl D: 65 TV Recl: 57 Wall Clr: 18

Weight: 69 / 85 lbs Cube: 41.32

Standard Pillows: N/A Finish Req: Y

Standard Cushions: High Resiliency 20 Standard Finish: N/A

COM: 3.75 yards

D	E	F	G	H	J	K _{COM}	L	M	N	O	P	Q	R	S	T	U	(# above U) *	S Nail	M Nail
3000	3012	3024	3036	3048	3060	3072	3084	3096	3108	3120	3132	3144	3156	3168	3180	3192	12 (Riser) + 3192 (U)	N/A	N/A

467C-MR

LIBBY LANGDON FOR FAIRFIELD, RECLINATION

Halsey Grande Manual Recliner

Manual Push Back Recliner

Width: 29.75 Depth: 35 Height: 42.75

AH: 26 SH: 20.5 SD: 19.5 IW: 22.5 Recl D: 66 TV Recl: 58 Wall Clr: 16

Weight: 88 / 88 lbs Cube: 34.38

Standard Pillows: N/A Finish Req: Y

Standard Cushions: High Resiliency 20 Standard Finish: N/A

COM: 7.5 yards

D	E	F	G	H	J	K _{COM}	L	M	N	O	P	Q	R	S	T	U	(# above U) *	S Nail	M Nail
3675	3696	3717	3738	3759	3780	3801	3822	3843	3864	3885	3906	3927	3948	3969	3990	4011	21 (Riser) + 4011 (U)	60	N/A

468C-MR

RECLINATION

Analeigh Manual Push Back Recliner

Width: 28.25 Depth: 33.75 Height: 41

AH: 26 SH: 18.5 SD: 22 IW: 24 Recl D: 65 TV Recl: 57 Wall Clr: 18

Weight: 69 / 85 lbs Cube: 43.25

Standard Pillows: N/A Finish Req: Y

Standard Cushions: High Resiliency 20 Standard Finish: N/A

COM: 3.75 yards

D	E	F	G	H	J	K _{COM}	L	M	N	O	P	Q	R	S	T	U	(# above U) *	S Nail	M Nail
3000	3012	3024	3036	3048	3060	3072	3084	3096	3108	3120	3132	3144	3156	3168	3180	3192	12 (Riser) + 3192 (U)	N/A	N/A

469C-MR

LIBBY LANGDON FOR FAIRFIELD, RECLINATION

Halsey Manual Push Back Recliner

Width: 29.75 Depth: 35 Height: 39.75

AH: 26 SH: 20.5 SD: 19.5 IW: 22.5 Recl D: 66 TV Recl: 58 Wall Clr: 16

Weight: 88 / 104 lbs Cube: 34.38

Standard Pillows: N/A Finish Req: Y

Standard Cushions: High Resiliency 20 Standard Finish: N/A

COM: 7.25 yards

D	E	F	G	H	J	K _{COM}	L	M	N	O	P	Q	R	S	T	U	(# above U) *	S Nail	M Nail
3600	3621	3642	3663	3684	3705	3726	3747	3768	3789	3810	3831	3852	3873	3894	3915	3936	21 (Riser) + 3936 (U)	60	N/A

469C-PR

LIBBY LANGDON FOR FAIRFIELD, RECLINATION

Halsey Power Recliner

Width: 29.75 Depth: 35 Height: 39.75

AH: 26 SH: 20.5 SD: 19.5 IW: 22.5 Recl D: 66 TV Recl: 58 Wall Clr: 16

Weight: 88 / 104 lbs Cube: 41.32

Standard Pillows: N/A Finish Req: Y

Standard Cushions: High Resiliency 20 Standard Finish: N/A

COM: 7.25 yards

D	E	F	G	H	J	K _{COM}	L	M	N	O	P	Q	R	S	T	U	(# above U) *	S Nail	M Nail
4050	4071	4092	4113	4134	4155	4176	4197	4218	4239	4260	4281	4302	4323	4344	4365	4386	21 (Riser) + 4386 (U)	60	N/A

470C-MR-2

RECLINATION

Infinity Manual Recliner

Brushed Nickel

Width: 28.25 Depth: 33.75 Height: 41

AH: 26 SH: 18.5 SD: 22 IW: 24 Recl D: 65 TV Recl: 57 Wall Clr: 18

Weight: 69 / 85 lbs Cube: 34.38

Standard Pillows: N/A Finish Req: N

Standard Cushions: High Resiliency 20 Standard Finish: BRUSHED NICKEL

COM: 3.75 yards

Metal Base in Nickel

D	E	F	G	H	J	K _{COM}	L	M	N	O	P	Q	R	S	T	U	(# above U) *	S Nail	M Nail
3375	3387	3399	3411	3423	3435	3447	3459	3471	3483	3495	3507	3519	3531	3543	3555	3567	12 (Riser) + 3567 (U)	N/A	N/A

UPHOLSTERY

470C-MR-6

RECLINATION

Infinity Manual Recliner

Brushed Brass

Width: 28.25 Depth: 33.75 Height: 41

AH: 26 SH: 18.5 SD: 22 IW: 24 Recl D: 65 TV Recl: 57 Wall Clr: 18

Weight: 69 / 88 lbs Cube: 43.25

Standard Pillows: N/A Finish Req: N

Standard Cushions: High Resiliency 20 Standard Finish: BRUSHED BRASS

COM: 3.75 yards

Metal Base in Brushed Brass

D	E	F	G	H	J	K _{COM}	L	M	N	O	P	Q	R	S	T	U	(# above U) *	S Nail	M Nail
3375	3387	3399	3411	3423	3435	3447	3459	3471	3483	3495	3507	3519	3531	3543	3555	3567	12 (Riser) + 3567 (U)	N/A	N/A

471C-MR

RECLINATION

Bridgett Manual Recliner

Width: 27 Depth: 33 Height: 43.5

AH: 26 SH: 19 SD: 20 IW: 21.5 Recl D: 64 TV Recl: 55 Wall Clr: 19.75

Weight: 90 / 119 lbs Cube: 43.25

Standard Pillows: N/A Finish Req: Y

Standard Cushions: High Resiliency 35 Standard Finish: N/A

COM: 3.5 yards

D	E	F	G	H	J	K _{COM}	L	M	N	O	P	Q	R	S	T	U	(# above U) *	S Nail	M Nail
2700	2712	2724	2736	2748	2760	2772	2784	2796	2808	2820	2832	2844	2856	2868	2880	2892	12 (Riser) + 2892 (U)	N/A	N/A

476C-MR

RECLINATION

Harrisburg Manual Recliner

Width: 32.25 Depth: 37.25 Height: 43.5

AH: 26.5 SH: 20 SD: 18 IW: 22 Recl D: 68 TV Recl: 59.25 Wall Clr: 18

Weight: 88 / 95 lbs Cube: 34.38

Standard Pillows: N/A Finish Req: Y

Standard Cushions: High Resiliency 20 Standard Finish: N/A

COM: 8.25 yards

D	E	F	G	H	J	K _{COM}	L	M	N	O	P	Q	R	S	T	U	(# above U) *	S Nail	M Nail
3600	3624	3648	3672	3696	3720	3744	3768	3792	3816	3840	3864	3888	3912	3936	3960	3984	24 (Riser) + 3984 (U)	N/A	N/A

476C-PR

RECLINATION

Harrisburg Power Reclination

Width: 32.25 Depth: 37.25 Height: 43.5

AH: 26.5 SH: 20 SD: 18 IW: 22 Recl D: 68 TV Recl: 59.25 Wall Clr: 18

Weight: 88 / 95 lbs Cube: 43.25

Standard Pillows: N/A Finish Req: Y

Standard Cushions: High Resiliency 20 Standard Finish: N/A

COM: 8.25 yards

D	E	F	G	H	J	K _{COM}	L	M	N	O	P	Q	R	S	T	U	(# above U) *	S Nail	M Nail
4050	4074	4098	4122	4146	4170	4194	4218	4242	4266	4290	4314	4338	4362	4386	4410	4434	24 (Riser) + 4434 (U)	N/A	N/A

5013-C6

Portside Counter Stool

Width: 23.75 Depth: 23 Height: 41.25

AH: 31.5 SH: 26 SD: 19.5 IW: 19.75

Weight: 22 / 33 lbs Cube: 17.77

Standard Pillows: N/A Finish Req: N

Standard Cushions: High Resiliency 30 Standard Finish: Natural

COM: 1.5 yards

Features natural cane accents that was handwoven using the peel of natural rattan. As with any natural product, nature's imperfections and hallmarks will be present in the cane materials. Cane is a handcrafted product dating back to the Ancient Egyptians.

D	E	F	G	H	J	K _{COM}	L	M	N	O	P	Q	R	S	T	U	(# above U) *	S Nail	M Nail
1950	1956	1962	1968	1974	1980	1986	1992	1998	2004	2010	2016	2022	2028	2034	2040	2046	6 (Riser) + 2046 (U)	N/A	N/A

5013-04

Portside Arm Chair

Width: 23 Depth: 24.25 Height: 35

AH: 24.5 SH: 19.25 SD: 21.5 IW: 19.75

Weight: 19 / 19 lbs Cube: 11.29

Standard Pillows: N/A Finish Req: N

Standard Cushions: High Resiliency 30 Standard Finish: Natural

COM: 1.5 yards

Features natural cane accents that was handwoven using the peel of natural rattan. As with any natural product, nature's imperfections and hallmarks will be present in the cane materials. Cane is a handcrafted product dating back to the Ancient Egyptians.

D	E	F	G	H	J	K _{COM}	L	M	N	O	P	Q	R	S	T	U	(# above U) *	S Nail	M Nail
1875	1881	1887	1893	1899	1905	1911	1917	1923	1929	1935	1941	1947	1953	1959	1965	1971	6 (Riser) + 1971 (U)	N/A	N/A

5013-05

Portside Side Chair

Width: 21 Depth: 24.5 Height: 35

AH: - SH: 19 SD: 21.5 IW: 21

Weight: 16 / 16 lbs Cube: 10.42

Standard Pillows: N/A Finish Req: N

Standard Cushions: High Resiliency 30 Standard Finish: Natural

COM: 1.5 yards

Features natural cane accents that was handwoven using the peel of natural rattan. As with any natural product, nature's imperfections and hallmarks will be present in the cane materials. Cane is a handcrafted product dating back to the Ancient Egyptians.

D	E	F	G	H	J	K _{COM}	L	M	N	O	P	Q	R	S	T	U	(# above U) *	S Nail	M Nail
1845	1851	1857	1863	1869	1875	1881	1887	1893	1899	1905	1911	1917	1923	1929	1935	1941	6 (Riser) + 1941 (U)	N/A	N/A

UPHOLSTERY

5013-06

Portside Bar Stool

Width: 23.75 **Depth:** 23 **Height:** 45.25
AH: - **SH:** 30 **SD:** 19.5 **IW:** 19.75
Weight: 22 / 22 lbs **Cube:** 14.3

Standard Pillows: N/A **Finish Req:** N
Standard Cushions: High Resiliency 30 **Standard Finish:** Natural
COM: 1.5 yards
 Features natural cane accents that was handwoven using the peel of natural rattan. As with any natural product, nature's imperfections and hallmarks will be present in the cane materials. Cane is a handcrafted product dating back to the Ancient Egyptians.

D	E	F	G	H	J	K _{COM}	L	M	N	O	P	Q	R	S	T	U	(# above U) *	S Nail	M Nail
1950	1956	1962	1968	1974	1980	1986	1992	1998	2004	2010	2016	2022	2028	2034	2040	2046	6 (Riser) + 2046 (U)	N/A	N/A

5026-C7

Darien Counter Stool

Width: 21 **Depth:** 24.5 **Height:** 40.5
AH: - **SH:** 26.5 **SD:** 19.5 **IW:** 21
Weight: 22 / 30 lbs **Cube:** 19.6

Standard Pillows: N/A **Finish Req:** Y
Standard Cushions: High Resiliency 40 **Standard Finish:** N/A
COM: 2.5 yards

D	E	F	G	H	J	K _{COM}	L	M	N	O	P	Q	R	S	T	U	(# above U) *	S Nail	M Nail
1440	1449	1458	1467	1476	1485	1494	1503	1512	1521	1530	1539	1548	1557	1566	1575	1584	9 (Riser) + 1584 (U)	45	N/A

5026-S4

Darien Side Chair with four casters

Width: 21 **Depth:** 24.5 **Height:** 34
AH: - **SH:** 20 **SD:** 19.5 **IW:** 21
Weight: 25 / 30 lbs **Cube:** 15.74

Standard Pillows: N/A **Finish Req:** Y
Standard Cushions: High Resiliency 40 **Standard Finish:** N/A
COM: 2.5 yards

D	E	F	G	H	J	K _{COM}	L	M	N	O	P	Q	R	S	T	U	(# above U) *	S Nail	M Nail
1422	1431	1440	1449	1458	1467	1476	1485	1494	1503	1512	1521	1530	1539	1548	1557	1566	9 (Riser) + 1566 (U)	45	N/A

5026-05

Darien Side Chair

Width: 21 **Depth:** 24.5 **Height:** 34
AH: - **SH:** 20 **SD:** 19.5 **IW:** 21
Weight: 25 / 30 lbs **Cube:** 15.74

Standard Pillows: N/A **Finish Req:** Y
Standard Cushions: High Resiliency 40 **Standard Finish:** N/A
COM: 2.25 yards

D	E	F	G	H	J	K _{COM}	L	M	N	O	P	Q	R	S	T	U	(# above U) *	S Nail	M Nail
1350	1359	1368	1377	1386	1395	1404	1413	1422	1431	1440	1449	1458	1467	1476	1485	1494	9 (Riser) + 1494 (U)	45	N/A

5026-07

Darien Bar Stool

Width: 21 **Depth:** 24.5 **Height:** 44.5
AH: - **SH:** 30.5 **SD:** 19.5 **IW:** 21
Weight: 22 / 30 lbs **Cube:** 17.77

Standard Pillows: N/A **Finish Req:** Y
Standard Cushions: High Resiliency 40 **Standard Finish:** N/A
COM: 2.5 yards

D	E	F	G	H	J	K _{COM}	L	M	N	O	P	Q	R	S	T	U	(# above U) *	S Nail	M Nail
1440	1449	1458	1467	1476	1485	1494	1503	1512	1521	1530	1539	1548	1557	1566	1575	1584	9 (Riser) + 1584 (U)	45	N/A

5035-C7

Orleans Counter Stool

Width: 19 **Depth:** 20 **Height:** 37.5
AH: - **SH:** 25.5 **SD:** 18 **IW:** 19
Weight: 30 / 40 lbs **Cube:** 15.74

Standard Pillows: N/A **Finish Req:** Y
Standard Cushions: High Resiliency 40 **Standard Finish:** N/A
COM: 2 yards

D	E	F	G	H	J	K _{COM}	L	M	N	O	P	Q	R	S	T	U	(# above U) *	S Nail	M Nail
1320	1326	1332	1338	1344	1350	1356	1362	1368	1374	1380	1386	1392	1398	1404	1410	1416	6 (Riser) + 1416 (U)	45	N/A

5035-07

Orleans Bar Stool

Width: 19 **Depth:** 20 **Height:** 41.5
AH: - **SH:** 29.5 **SD:** 18 **IW:** 19
Weight: 30 / 41 lbs **Cube:** 17.77

Standard Pillows: N/A **Finish Req:** Y
Standard Cushions: High Resiliency 40 **Standard Finish:** N/A
COM: 2 yards

D	E	F	G	H	J	K _{COM}	L	M	N	O	P	Q	R	S	T	U	(# above U) *	S Nail	M Nail
1320	1326	1332	1338	1344	1350	1356	1362	1368	1374	1380	1386	1392	1398	1404	1410	1416	6 (Riser) + 1416 (U)	45	N/A

UPHOLSTERY

5049-A4

Standard Pillows: N/A **Finish Req:** Y
Standard Cushions: High Resiliency 40 **Standard Finish:** N/A
COM: 2.25 yards

Dilworth Arm Chair

Width: 22.5 **Depth:** 23.5 **Height:** 35.5
AH: 25.5 **SH:** 19 **SD:** 19.5 **IW:** 19
Weight: 30 / 40 lbs **Cube:** 15.74

D	E	F	G	H	J	K _{COM}	L	M	N	O	P	Q	R	S	T	U	(# above U) *	S Nail	M Nail
1422	1428	1434	1440	1446	1452	1458	1464	1470	1476	1482	1488	1494	1500	1506	1512	1518	6 (Riser) + 1518 (U)	45	60

5049-C7

Standard Pillows: N/A **Finish Req:** Y
Standard Cushions: High Resiliency 40 **Standard Finish:** N/A
COM: 2 yards

Dilworth Counter Stool

Width: 19.5 **Depth:** 22 **Height:** 37
AH: - **SH:** 26 **SD:** 19 **IW:** 19.5
Weight: 21 / 31 lbs **Cube:** 15.74

D	E	F	G	H	J	K _{COM}	L	M	N	O	P	Q	R	S	T	U	(# above U) *	S Nail	M Nail
1455	1461	1467	1473	1479	1485	1491	1497	1503	1509	1515	1521	1527	1533	1539	1545	1551	6 (Riser) + 1551 (U)	45	60

5049-04

Standard Pillows: N/A **Finish Req:** Y
Standard Cushions: High Resiliency 40 **Standard Finish:** N/A
COM: 2.25 yards

Dilworth Arm Chair

Width: 22.5 **Depth:** 23.5 **Height:** 35.5
AH: 25.5 **SH:** 19 **SD:** 19.5 **IW:** 19
Weight: 30 / 40 lbs **Cube:** 15.74

D	E	F	G	H	J	K _{COM}	L	M	N	O	P	Q	R	S	T	U	(# above U) *	S Nail	M Nail
1350	1356	1362	1368	1374	1380	1386	1392	1398	1404	1410	1416	1422	1428	1434	1440	1446	6 (Riser) + 1446 (U)	45	60

5049-05

Standard Pillows: N/A **Finish Req:** Y
Standard Cushions: High Resiliency 40 **Standard Finish:** N/A
COM: 2 yards

Dilworth Side Chair

Width: 19 **Depth:** 23 **Height:** 35.5
AH: - **SH:** 19 **SD:** 19 **IW:** 19
Weight: 20 / 30 lbs **Cube:** 15.74

D	E	F	G	H	J	K _{COM}	L	M	N	O	P	Q	R	S	T	U	(# above U) *	S Nail	M Nail
1320	1326	1332	1338	1344	1350	1356	1362	1368	1374	1380	1386	1392	1398	1404	1410	1416	6 (Riser) + 1416 (U)	45	60

5049-07

Standard Pillows: N/A **Finish Req:** Y
Standard Cushions: High Resiliency 40 **Standard Finish:** N/A
COM: 2 yards

Dilworth Bar Stool

Width: 19.5 **Depth:** 22 **Height:** 41
AH: - **SH:** 30 **SD:** 19 **IW:** 19.5
Weight: 22 / 34 lbs **Cube:** 15.74

D	E	F	G	H	J	K _{COM}	L	M	N	O	P	Q	R	S	T	U	(# above U) *	S Nail	M Nail
1455	1461	1467	1473	1479	1485	1491	1497	1503	1509	1515	1521	1527	1533	1539	1545	1551	6 (Riser) + 1551 (U)	45	60

5072-05

Standard Pillows: N/A **Finish Req:** Y
Standard Cushions: High Resiliency 40 **Standard Finish:** N/A
COM: 2.75 yards

Gavin Side Chair

Width: 22 **Depth:** 24.5 **Height:** 36
AH: - **SH:** 18 **SD:** 19.5 **IW:** 20
Weight: 23 / 33 lbs **Cube:** 15.74

D	E	F	G	H	J	K _{COM}	L	M	N	O	P	Q	R	S	T	U	(# above U) *	S Nail	M Nail
1500	1509	1518	1527	1536	1545	1554	1563	1572	1581	1590	1599	1608	1617	1626	1635	1644	9 (Riser) + 1644 (U)	45	N/A

5094-C7

Standard Pillows: N/A **Finish Req:** Y
Standard Cushions: High Resiliency 40 **Standard Finish:** N/A
COM: 2.25 yards

Roxanne Counter Stool

Width: 20 **Depth:** 21 **Height:** 38.5
AH: - **SH:** 26.5 **SD:** 16 **IW:** 20
Weight: 22 / 32 lbs **Cube:** 15.74

D	E	F	G	H	J	K _{COM}	L	M	N	O	P	Q	R	S	T	U	(# above U) *	S Nail	M Nail
1305	1311	1317	1323	1329	1335	1341	1347	1353	1359	1365	1371	1377	1383	1389	1395	1401	6 (Riser) + 1401 (U)	45	N/A

UPHOLSTERY

5094-07

Standard Pillows: N/A Finish Req: Y
 Standard Cushions: High Resiliency 40 Standard Finish: N/A
 COM: 2.25 yards

Roxanne Bar Stool

Width: 20 Depth: 21 Height: 42.5
 AH: - SH: 30 SD: 16 IW: 20
 Weight: 22 / 33 lbs Cube: 17.77

D	E	F	G	H	J	K _{COM}	L	M	N	O	P	Q	R	S	T	U	(# above U) *	S Nail	M Nail
1305	1311	1317	1323	1329	1335	1341	1347	1353	1359	1365	1371	1377	1383	1389	1395	1401	6 (Riser) + 1401 (U)	45	N/A

5095-C6

Standard Pillows: N/A Finish Req: Y
 Standard Cushions: High Resiliency 40 Standard Finish: N/A
 COM: 1.75 yards

Ramsey Counter Stool

Width: 22 Depth: 21.5 Height: 38.5
 AH: 29.5 SH: 24 SD: 17.5 IW: 18
 Weight: 30 / 35 lbs Cube: 15.74

D	E	F	G	H	J	K _{COM}	L	M	N	O	P	Q	R	S	T	U	(# above U) *	S Nail	M Nail
1260	1266	1272	1278	1284	1290	1296	1302	1308	1314	1320	1326	1332	1338	1344	1350	1356	6 (Riser) + 1356 (U)	45	60

5115-E1

Standard Pillows: N/A Finish Req: Y
 Standard Cushions: High Resiliency 30 Standard Finish: N/A
 COM: 3.75 yards

Marcel EasyClean Wing Chair

Width: 27.25 Depth: 30.5 Height: 42
 AH: 25 SH: 18.5 SD: 20 IW: 23
 Weight: 39 / 48 lbs Cube: 27.3

D	E	F	G	H	J	K _{COM}	L	M	N	O	P	Q	R	S	T	U	(# above U) *	S Nail	M Nail
2430	2442	2454	2466	2478	2490	2502	2514	2526	2538	2550	2562	2574	2586	2598	2610	2622	12 (Riser) + 2622 (U)	60	N/A

5115-01

Standard Pillows: N/A Finish Req: Y
 Standard Cushions: High Resiliency 30 Standard Finish: N/A
 COM: 3.75 yards

Marcel Wing Chair

Width: 27.25 Depth: 30.5 Height: 42
 AH: 25 SH: 18.5 SD: 20 IW: 23
 Weight: 39 / 54 lbs Cube: 27.3

D	E	F	G	H	J	K _{COM}	L	M	N	O	P	Q	R	S	T	U	(# above U) *	S Nail	M Nail
2430	2442	2454	2466	2478	2490	2502	2514	2526	2538	2550	2562	2574	2586	2598	2610	2622	12 (Riser) + 2622 (U)	60	N/A

5134-01

Standard Pillows: N/A Finish Req: Y
 Standard Cushions: High Resiliency 40 Standard Finish: N/A
 COM: 5 yards

Frances Wing Chair

Width: 28.25 Depth: 35.5 Height: 44.5
 AH: 21.5 SH: 18 SD: 21 IW: 22
 Weight: 50 / 66 lbs Cube: 34.38

D	E	F	G	H	J	K _{COM}	L	M	N	O	P	Q	R	S	T	U	(# above U) *	S Nail	M Nail
2355	2370	2385	2400	2415	2430	2445	2460	2475	2490	2505	2520	2535	2550	2565	2580	2595	15 (Riser) + 2595 (U)	Std.	N/A

5158-01

Standard Pillows: N/A Finish Req: Y
 Standard Cushions: High Resiliency 20 Standard Finish: N/A
 COM: 4.75 yards

Downey Wing Chair

Width: 29.5 Depth: 33 Height: 41.5
 AH: 24.5 SH: 20 SD: 21.5 IW: 22.5
 Weight: 55 / 65 lbs Cube: 34.38

D	E	F	G	H	J	K _{COM}	L	M	N	O	P	Q	R	S	T	U	(# above U) *	S Nail	M Nail
2265	2280	2295	2310	2325	2340	2355	2370	2385	2400	2415	2430	2445	2460	2475	2490	2505	15 (Riser) + 2505 (U)	N/A	N/A

5198-A2

Standard Pillows: N/A Finish Req: Y
 Standard Cushions: High Resiliency 40 Standard Finish: N/A
 COM: 2.25 yards

Warwick Occasional Chair

Width: 23.5 Depth: 26.5 Height: 35
 AH: 25.5 SH: 17.5 SD: 19 IW: 18
 Weight: 35 / 40 lbs Cube: 15.74

D	E	F	G	H	J	K _{COM}	L	M	N	O	P	Q	R	S	T	U	(# above U) *	S Nail	M Nail
1350	1359	1368	1377	1386	1395	1404	1413	1422	1431	1440	1449	1458	1467	1476	1485	1494	9 (Riser) + 1494 (U)	45	60

UPHOLSTERY

5198-A4

Standard Pillows: N/A **Finish Req:** Y
Standard Cushions: High Resiliency 40 **Standard Finish:** N/A
COM: 2.25 yards

Warwick Occasional Chair

Width: 23.5 **Depth:** 26.5 **Height:** 36
AH: 25.5 **SH:** 17.5 **SD:** 19 **IW:** 18
Weight: 35 / 40 lbs **Cube:** 15.74

D	E	F	G	H	J	K _{COM}	L	M	N	O	P	Q	R	S	T	U	(# above U) *	S Nail	M Nail
1386	1395	1404	1413	1422	1431	1440	1449	1458	1467	1476	1485	1494	1503	1512	1521	1530	9 (Riser) + 1530 (U)	45	60

5198-01

Standard Pillows: N/A **Finish Req:** Y
Standard Cushions: High Resiliency 40 **Standard Finish:** N/A
COM: 2.25 yards

Warwick Occasional Chair

Width: 23.5 **Depth:** 26.5 **Height:** 35
AH: 25.5 **SH:** 17.5 **SD:** 19 **IW:** 18
Weight: 35 / 40 lbs **Cube:** 15.74

D	E	F	G	H	J	K _{COM}	L	M	N	O	P	Q	R	S	T	U	(# above U) *	S Nail	M Nail
1314	1323	1332	1341	1350	1359	1368	1377	1386	1395	1404	1413	1422	1431	1440	1449	1458	9 (Riser) + 1458 (U)	45	60

5204-01

Standard Pillows: N/A **Finish Req:** Y
Standard Cushions: High Resiliency 30 **Standard Finish:** N/A
COM: 3.5 yards

Norton Occasional Chair

Width: 28 **Depth:** 29.5 **Height:** 35
AH: 24.5 **SH:** 20 **SD:** 21 **IW:** 21
Weight: 35 / 40 lbs **Cube:** 21.65

D	E	F	G	H	J	K _{COM}	L	M	N	O	P	Q	R	S	T	U	(# above U) *	S Nail	M Nail
1650	1662	1674	1686	1698	1710	1722	1734	1746	1758	1770	1782	1794	1806	1818	1830	1842	12 (Riser) + 1842 (U)	Std.	N/A

5206-01

Standard Pillows: N/A **Finish Req:** Y
Standard Cushions: High Resiliency 20 **Standard Finish:** N/A
COM: 4.75 yards

Cecilia Lounge Chair

Width: 31 **Depth:** 32 **Height:** 39
AH: 27 **SH:** 19.5 **SD:** 20.5 **IW:** 20.5
Weight: 40 / 50 lbs **Cube:** 23.83

D	E	F	G	H	J	K _{COM}	L	M	N	O	P	Q	R	S	T	U	(# above U) *	S Nail	M Nail
2280	2295	2310	2325	2340	2355	2370	2385	2400	2415	2430	2445	2460	2475	2490	2505	2520	15 (Riser) + 2520 (U)	45	60

5345-01

Standard Pillows: N/A **Finish Req:** Y
Standard Cushions: High Resiliency 40 **Standard Finish:** N/A
COM: 2.75 yards

Sophia Occasional Chair

Width: 24 **Depth:** 27.5 **Height:** 37
AH: 26 **SH:** 20 **SD:** 20 **IW:** 19
Weight: 25 / 30 lbs **Cube:** 21.65

D	E	F	G	H	J	K _{COM}	L	M	N	O	P	Q	R	S	T	U	(# above U) *	S Nail	M Nail
1575	1584	1593	1602	1611	1620	1629	1638	1647	1656	1665	1674	1683	1692	1701	1710	1719	9 (Riser) + 1719 (U)	N/A	N/A

5400-01

Standard Pillows: N/A **Finish Req:** Y
Standard Cushions: High Resiliency 40 **Standard Finish:** N/A
COM: 2.75 yards

Granger Occasional Chair

Width: 28 **Depth:** 28 **Height:** 40.5
AH: 28.5 **SH:** 20.5 **SD:** 20 **IW:** 23.5
Weight: 35 / 45 lbs **Cube:** 23.22

D	E	F	G	H	J	K _{COM}	L	M	N	O	P	Q	R	S	T	U	(# above U) *	S Nail	M Nail
1470	1479	1488	1497	1506	1515	1524	1533	1542	1551	1560	1569	1578	1587	1596	1605	1614	9 (Riser) + 1614 (U)	45	N/A

5410-A4

Standard Pillows: N/A **Finish Req:** Y
Standard Cushions: High Resiliency 40 **Standard Finish:** N/A
COM: 2.25 yards

Allen Occasional Chair

Width: 25 **Depth:** 27 **Height:** 37.5
AH: 26.5 **SH:** 20.5 **SD:** 20 **IW:** 18
Weight: 35 / 40 lbs **Cube:** 21.65

D	E	F	G	H	J	K _{COM}	L	M	N	O	P	Q	R	S	T	U	(# above U) *	S Nail	M Nail
1410	1419	1428	1437	1446	1455	1464	1473	1482	1491	1500	1509	1518	1527	1536	1545	1554	9 (Riser) + 1554 (U)	Std.	N/A

UPHOLSTERY

5418-04

Sabine Arm Chair

Standard Pillows: N/A **Finish Req:** Y
Standard Cushions: High Resiliency 40 **Standard Finish:** N/A
COM: 3.75 yards

Width: 26.5 **Depth:** 26.5 **Height:** 39
AH: 24.25 **SH:** 20 **SD:** 20.25 **IW:** 22.5
Weight: 25 / 28 lbs **Cube:** 21.65

D	E	F	G	H	J	K _{COM}	L	M	N	O	P	Q	R	S	T	U	(# above U) *	S Nail	M Nail
2130	2142	2154	2166	2178	2190	2202	2214	2226	2238	2250	2262	2274	2286	2298	2310	2322	12 (Riser) + 2322 (U)	N/A	N/A

5426-01

Linton Wing Chair

Standard Pillows: N/A **Finish Req:** Y
Standard Cushions: High Resiliency 40 **Standard Finish:** N/A
COM: 4.75 yards

Width: 30.25 **Depth:** 29 **Height:** 41
AH: 26 **SH:** 19.5 **SD:** 21 **IW:** 21
Weight: 40 / 55 lbs **Cube:** 23.89

D	E	F	G	H	J	K _{COM}	L	M	N	O	P	Q	R	S	T	U	(# above U) *	S Nail	M Nail
2010	2025	2040	2055	2070	2085	2100	2115	2130	2145	2160	2175	2190	2205	2220	2235	2250	15 (Riser) + 2250 (U)	Std.	15

5432-A4

Chatham Arm Chair

Standard Pillows: N/A **Finish Req:** Y
Standard Cushions: High Resiliency 55 **Standard Finish:** N/A
COM: 2 yards

Width: 23 **Depth:** 24 **Height:** 37.5
AH: 24.5 **SH:** 19.5 **SD:** 19 **IW:** 18.5
Weight: 30 / 35 lbs **Cube:** 15.74

D	E	F	G	H	J	K _{COM}	L	M	N	O	P	Q	R	S	T	U	(# above U) *	S Nail	M Nail
1272	1278	1284	1290	1296	1302	1308	1314	1320	1326	1332	1338	1344	1350	1356	1362	1368	6 (Riser) + 1368 (U)	45	N/A

5432-04

Chatham Arm Chair

Standard Pillows: N/A **Finish Req:** Y
Standard Cushions: High Resiliency 55 **Standard Finish:** N/A
COM: 2 yards

Width: 23 **Depth:** 24 **Height:** 37.5
AH: 24.5 **SH:** 19.5 **SD:** 19 **IW:** 18.5
Weight: 30 / 35 lbs **Cube:** 15.74

D	E	F	G	H	J	K _{COM}	L	M	N	O	P	Q	R	S	T	U	(# above U) *	S Nail	M Nail
1155	1161	1167	1173	1179	1185	1191	1197	1203	1209	1215	1221	1227	1233	1239	1245	1251	6 (Riser) + 1251 (U)	45	N/A

5434-A4

Delano Arm Chair

Standard Pillows: N/A **Finish Req:** Y
Standard Cushions: High Resiliency 55 **Standard Finish:** N/A
COM: 2 yards

Width: 24 **Depth:** 27 **Height:** 38
AH: 25.5 **SH:** 19 **SD:** 20 **IW:** 20.5
Weight: 35 / 40 lbs **Cube:** 21.09

D	E	F	G	H	J	K _{COM}	L	M	N	O	P	Q	R	S	T	U	(# above U) *	S Nail	M Nail
1272	1278	1284	1290	1296	1302	1308	1314	1320	1326	1332	1338	1344	1350	1356	1362	1368	6 (Riser) + 1368 (U)	45	N/A

5434-04

Delano Arm Chair

Standard Pillows: N/A **Finish Req:** Y
Standard Cushions: High Resiliency 55 **Standard Finish:** N/A
COM: 2 yards

Width: 23 **Depth:** 24 **Height:** 37.5
AH: 25.5 **SH:** 19 **SD:** 20 **IW:** 20.5
Weight: 30 / 35 lbs **Cube:** 15.74

D	E	F	G	H	J	K _{COM}	L	M	N	O	P	Q	R	S	T	U	(# above U) *	S Nail	M Nail
1200	1206	1212	1218	1224	1230	1236	1242	1248	1254	1260	1266	1272	1278	1284	1290	1296	6 (Riser) + 1296 (U)	45	N/A

5452-A4

Lori Arm Chair

Standard Pillows: N/A **Finish Req:** Y
Standard Cushions: High Resiliency 55 **Standard Finish:** N/A
COM: 2 yards

Width: 23 **Depth:** 24 **Height:** 37.5
AH: 24.5 **SH:** 19.5 **SD:** 19 **IW:** 18.5
Weight: 30 / 40 lbs **Cube:** 15.74

D	E	F	G	H	J	K _{COM}	L	M	N	O	P	Q	R	S	T	U	(# above U) *	S Nail	M Nail
1272	1278	1284	1290	1296	1302	1308	1314	1320	1326	1332	1338	1344	1350	1356	1362	1368	6 (Riser) + 1368 (U)	45	N/A

UPHOLSTERY

5452-04

Lori Arm Chair

Standard Pillows: N/A **Finish Req:** Y
Standard Cushions: High Resiliency 55 **Standard Finish:** N/A
COM: 2 yards

Width: 23 **Depth:** 24 **Height:** 37.5
AH: 24.5 **SH:** 19.5 **SD:** 19 **IW:** 18.5
Weight: 30 / 40 lbs **Cube:** 15.74

D	E	F	G	H	J	K COM	L	M	N	O	P	Q	R	S	T	U	(# above U) *	S Nail	M Nail
1200	1206	1212	1218	1224	1230	1236	1242	1248	1254	1260	1266	1272	1278	1284	1290	1296	6 (Riser) + 1296 (U)	45	N/A

5462-01

Hawley Lounge Chair

Standard Pillows: N/A **Finish Req:** Y
Standard Cushions: High Resiliency 30 **Standard Finish:** N/A
COM: 6.5 yards

Width: 30 **Depth:** 38.5 **Height:** 39.5
AH: 23.5 **SH:** 17 **SD:** 22.5 **IW:** 21.5
Weight: 65 / 75 lbs **Cube:** 33.92

D	E	F	G	H	J	K COM	L	M	N	O	P	Q	R	S	T	U	(# above U) *	S Nail	M Nail
1950	1968	1986	2004	2022	2040	2058	2076	2094	2112	2130	2148	2166	2184	2202	2220	2238	18 (Riser) + 2238 (U)	60	75

5462-20

Hawley Ottoman

Standard Pillows: N/A **Finish Req:** Y
Standard Cushions: High Resiliency 30 **Standard Finish:** N/A
COM: 2 yards

Width: 26.5 **Depth:** 20 **Height:** 18
AH: - **SH:** - **SD:** - **IW:** -
Weight: 25 / 30 lbs **Cube:** 10.77

D	E	F	G	H	J	K COM	L	M	N	O	P	Q	R	S	T	U	(# above U) *	S Nail	M Nail
900	906	912	918	924	930	936	942	948	954	960	966	972	978	984	990	996	6 (Riser) + 996 (U)	30	45

5474-05

Bartow Side Chair

Standard Pillows: N/A **Finish Req:** Y
Standard Cushions: High Resiliency 40 **Standard Finish:** N/A
COM: 3.25 yards

Width: 24 **Depth:** 30 **Height:** 46.5
AH: - **SH:** 20 **SD:** 19 **IW:** 24
Weight: 30 / 40 lbs **Cube:** 21.65

D	E	F	G	H	J	K COM	L	M	N	O	P	Q	R	S	T	U	(# above U) *	S Nail	M Nail
1545	1557	1569	1581	1593	1605	1617	1629	1641	1653	1665	1677	1689	1701	1713	1725	1737	12 (Riser) + 1737 (U)	Std.	15

5481-01

Marley Occasional Chair

Standard Pillows: N/A **Finish Req:** Y
Standard Cushions: High Resiliency 40 **Standard Finish:** N/A
COM: 3.25 yards

Width: 26.5 **Depth:** 31 **Height:** 34.5
AH: - **SH:** 18.5 **SD:** 21 **IW:** -
Weight: 28 / 41 lbs **Cube:** 21.65

D	E	F	G	H	J	K COM	L	M	N	O	P	Q	R	S	T	U	(# above U) *	S Nail	M Nail
1875	1887	1899	1911	1923	1935	1947	1959	1971	1983	1995	2007	2019	2031	2043	2055	2067	12 (Riser) + 2067 (U)	Std.	N/A

5484-05

Leon Side Chair

Standard Pillows: N/A **Finish Req:** Y
Standard Cushions: High Resiliency 40 **Standard Finish:** N/A
COM: 2.5 yards

Width: 24 **Depth:** 30 **Height:** 46.5
AH: - **SH:** 21 **SD:** 20 **IW:** 24
Weight: 30 / 45 lbs **Cube:** 24.14

D	E	F	G	H	J	K COM	L	M	N	O	P	Q	R	S	T	U	(# above U) *	S Nail	M Nail
1380	1389	1398	1407	1416	1425	1434	1443	1452	1461	1470	1479	1488	1497	1506	1515	1524	9 (Riser) + 1524 (U)	45	60

5493-01

Silvio Occasional Chair

Standard Pillows: N/A **Finish Req:** Y
Standard Cushions: High Resiliency 35 **Standard Finish:** N/A
COM: 2.75 yards

Width: 27 **Depth:** 31.75 **Height:** 35.5
AH: 24 **SH:** 20.5 **SD:** 18.75 **IW:** 22.25
Weight: 40 / 40 lbs **Cube:** 17.61

Features natural cane accents that was handwoven using the peel of natural rattan. As with any natural product, nature's imperfections and hallmarks will be present in the cane materials. Cane is a handcrafted product with artisanal origins dating back to

D	E	F	G	H	J	K COM	L	M	N	O	P	Q	R	S	T	U	(# above U) *	S Nail	M Nail
1875	1884	1893	1902	1911	1920	1929	1938	1947	1956	1965	1974	1983	1992	2001	2010	2019	9 (Riser) + 2019 (U)	N/A	N/A

UPHOLSTERY

5706-40

Standard Pillows: (2) 16 x 16 **Finish Req:** Y
Standard Cushions: Ultra Plush **Standard Finish:** N/A
COM: 9.75 yards

Leland Settee

Width: 54.5 **Depth:** 36 **Height:** 35
AH: 25 **SH:** 21.5 **SD:** 24 **IW:** 45
Weight: 75 / 102 lbs **Cube:** 50.95

D	E	F	G	H	J	K _{COM}	L	M	N	O	P	Q	R	S	T	U	(# above U) *	S Nail	M Nail
3000	3030	3060	3090	3120	3150	3180	3210	3240	3270	3300	3330	3360	3390	3420	3450	3480	30 (Riser) + 3480 (U)	60	75

5719-01

Standard Pillows: N/A **Finish Req:** Y
Standard Cushions: High Resiliency 30 **Standard Finish:** N/A
COM: 4.25 yards

Bridgeport Occasional Chair

Width: 26.5 **Depth:** 31 **Height:** 37.5
AH: 25.5 **SH:** 19 **SD:** 21 **IW:** 19.5
Weight: 40 / 50 lbs **Cube:** 23.22

D	E	F	G	H	J	K _{COM}	L	M	N	O	P	Q	R	S	T	U	(# above U) *	S Nail	M Nail
1770	1782	1794	1806	1818	1830	1842	1854	1866	1878	1890	1902	1914	1926	1938	1950	1962	12 (Riser) + 1962 (U)	N/A	N/A

5744-40

Standard Pillows: N/A **Finish Req:** Y
Standard Cushions: High Resiliency 30 **Standard Finish:** N/A
COM: 5 yards

Dewey Settee

Width: 47 **Depth:** 27 **Height:** 38.5
AH: - **SH:** 20.5 **SD:** 20.5 **IW:** -
Weight: 50 / 60 lbs **Cube:** 42.5

D	E	F	G	H	J	K _{COM}	L	M	N	O	P	Q	R	S	T	U	(# above U) *	S Nail	M Nail
1815	1830	1845	1860	1875	1890	1905	1920	1935	1950	1965	1980	1995	2010	2025	2040	2055	15 (Riser) + 2055 (U)	N/A	Std.

5751-40

Standard Pillows: (2) 11 x 20 Kidney **Finish Req:** Y
Standard Cushions: High Resiliency 40 **Standard Finish:** N/A
COM: 11 yards

Bastille Settee

Width: 66.5 **Depth:** 31 **Height:** 40.5
AH: 40.5 **SH:** 20 **SD:** 21.5 **IW:** 56
Weight: 87 / 117 lbs **Cube:** 55.51

D	E	F	G	H	J	K _{COM}	L	M	N	O	P	Q	R	S	T	U	(# above U) *	S Nail	M Nail
3060	3090	3120	3150	3180	3210	3240	3270	3300	3330	3360	3390	3420	3450	3480	3510	3540	30 (Riser) + 3540 (U)	N/A	N/A

6001-A4

Standard Pillows: N/A **Finish Req:** Y
Standard Cushions: High Resiliency 40 **Standard Finish:** N/A
COM: 3.75 yards

Lawrence Arm Chair

Width: 24.5 **Depth:** 30 **Height:** 42.5
AH: 26 **SH:** 20.5 **SD:** 20.5 **IW:** 20.5
Weight: 35 / 45 lbs **Cube:** 26.89

D	E	F	G	H	J	K _{COM}	L	M	N	O	P	Q	R	S	T	U	(# above U) *	S Nail	M Nail
1725	1737	1749	1761	1773	1785	1797	1809	1821	1833	1845	1857	1869	1881	1893	1905	1917	12 (Riser) + 1917 (U)	45	60

6001-01

Standard Pillows: N/A **Finish Req:** Y
Standard Cushions: High Resiliency 40 **Standard Finish:** N/A
COM: 3.75 yards

Lawrence Arm Chair

Width: 24.5 **Depth:** 30 **Height:** 42.5
AH: 26 **SH:** 20.5 **SD:** 20.5 **IW:** 20.5
Weight: 35 / 48 lbs **Cube:** 21.65

D	E	F	G	H	J	K _{COM}	L	M	N	O	P	Q	R	S	T	U	(# above U) *	S Nail	M Nail
1650	1662	1674	1686	1698	1710	1722	1734	1746	1758	1770	1782	1794	1806	1818	1830	1842	12 (Riser) + 1842 (U)	45	60

6007-A2

Standard Pillows: N/A **Finish Req:** Y
Standard Cushions: High Resiliency 40 **Standard Finish:** N/A
COM: 2.75 yards
 Features Clean Out at back of seat. Standard with 2 front casters

Niobi Arm Chair

Two Casters, Clean Out Seat

Width: 24.5 **Depth:** 23.5 **Height:** 33
AH: 25 **SH:** 19 **SD:** 18 **IW:** 20
Weight: 25 / 25 lbs **Cube:** 15.74

D	E	F	G	H	J	K _{COM}	L	M	N	O	P	Q	R	S	T	U	(# above U) *	S Nail	M Nail
1956	1965	1974	1983	1992	2001	2010	2019	2028	2037	2046	2055	2064	2073	2082	2091	2100	9 (Riser) + 2100 (U)	N/A	N/A

UPHOLSTERY

6007-A4

Niobi Arm Chair

Four Casters, Clean Out Seat

Width: 24.5 Depth: 23.5 Height: 33

AH: 25 SH: 19 SD: 18 IW: 20

Weight: 25 / 35 lbs Cube: 15.74

Standard Pillows: N/A Finish Req: Y

Standard Cushions: High Resiliency 40 Standard Finish: N/A

COM: 2.75 yards

Features Clean Out at back of seat. Standard with 4 casters

D	E	F	G	H	J	K COM	L	M	N	O	P	Q	R	S	T	U	(# above U) *	S Nail	M Nail
1992	2001	2010	2019	2028	2037	2046	2055	2064	2073	2082	2091	2100	2109	2118	2127	2136	9 (Riser) + 2136 (U)	N/A	N/A

6007-04

Niobi Arm Chair

Clean Out Seat

Width: 24.5 Depth: 23.5 Height: 33

AH: 25 SH: 19 SD: 18 IW: 20

Weight: 25 / 25 lbs Cube: 15.74

Standard Pillows: N/A Finish Req: Y

Standard Cushions: High Resiliency 40 Standard Finish: N/A

COM: 2.75 yards

Features Clean Out at back of seat

D	E	F	G	H	J	K COM	L	M	N	O	P	Q	R	S	T	U	(# above U) *	S Nail	M Nail
1920	1929	1938	1947	1956	1965	1974	1983	1992	2001	2010	2019	2028	2037	2046	2055	2064	9 (Riser) + 2064 (U)	N/A	N/A

6012-01

Layne Occasional Chair

Width: 31 Depth: 34 Height: 33

AH: 20 SH: 18 SD: 20.5 IW: 26.5

Weight: 31 / 44 lbs Cube: 23.89

Standard Pillows: N/A Finish Req: Y

Standard Cushions: High Resiliency 40 Standard Finish: N/A

COM: 3.75 yards

D	E	F	G	H	J	K COM	L	M	N	O	P	Q	R	S	T	U	(# above U) *	S Nail	M Nail
2145	2157	2169	2181	2193	2205	2217	2229	2241	2253	2265	2277	2289	2301	2313	2325	2337	12 (Riser) + 2337 (U)	N/A	N/A

6014-A2

Aiden Occasional Chair

Width: 26 Depth: 26.5 Height: 32

AH: 24 SH: 20 SD: 19.5 IW: 19

Weight: 29 / 42 lbs Cube: 21.65

Standard Pillows: N/A Finish Req: Y

Standard Cushions: High Resiliency 40 Standard Finish: N/A

COM: 3.75 yards

D	E	F	G	H	J	K COM	L	M	N	O	P	Q	R	S	T	U	(# above U) *	S Nail	M Nail
1626	1638	1650	1662	1674	1686	1698	1710	1722	1734	1746	1758	1770	1782	1794	1806	1818	12 (Riser) + 1818 (U)	60	75

6014-A4

Aiden Occasional Chair

Width: 26 Depth: 26.5 Height: 32

AH: 24 SH: 20 SD: 19.5 IW: 19

Weight: 27 / 32 lbs Cube: 21.65

Standard Pillows: N/A Finish Req: Y

Standard Cushions: High Resiliency 40 Standard Finish: N/A

COM: 3.75 yards

D	E	F	G	H	J	K COM	L	M	N	O	P	Q	R	S	T	U	(# above U) *	S Nail	M Nail
1662	1674	1686	1698	1710	1722	1734	1746	1758	1770	1782	1794	1806	1818	1830	1842	1854	12 (Riser) + 1854 (U)	60	75

6014-01

Aiden Occasional Chair

Width: 26 Depth: 26.5 Height: 32

AH: 24 SH: 20 SD: 19.5 IW: 19

Weight: 29 / 42 lbs Cube: 21.65

Standard Pillows: N/A Finish Req: Y

Standard Cushions: High Resiliency 40 Standard Finish: N/A

COM: 3.75 yards

D	E	F	G	H	J	K COM	L	M	N	O	P	Q	R	S	T	U	(# above U) *	S Nail	M Nail
1590	1602	1614	1626	1638	1650	1662	1674	1686	1698	1710	1722	1734	1746	1758	1770	1782	12 (Riser) + 1782 (U)	60	75

6016-01

Lockport Occasional Chair

Width: 23.5 Depth: 25 Height: 32

AH: 25.5 SH: 19 SD: 20 IW: 19

Weight: 25 / 35 lbs Cube: 15.74

Standard Pillows: N/A Finish Req: Y

Standard Cushions: High Resiliency 40 Standard Finish: N/A

COM: 2 yards

D	E	F	G	H	J	K COM	L	M	N	O	P	Q	R	S	T	U	(# above U) *	S Nail	M Nail
1290	1296	1302	1308	1314	1320	1326	1332	1338	1344	1350	1356	1362	1368	1374	1380	1386	6 (Riser) + 1386 (U)	N/A	N/A

UPHOLSTERY

6018-C7

Standard Pillows: N/A **Finish Req:** Y
Standard Cushions: High Resiliency 40 **Standard Finish:** N/A
COM: 3.5 yards

Dora Counter Stool

Width: 20.5 **Depth:** 25 **Height:** 42
AH: - **SH:** 26.5 **SD:** 17.5 **IW:** 20.5
Weight: 30 / 41 lbs **Cube:** 17.77

D	E	F	G	H	J	K _{COM}	L	M	N	O	P	Q	R	S	T	U	(# above U) *	S Nail	M Nail
1545	1554	1563	1572	1581	1590	1599	1608	1617	1626	1635	1644	1653	1662	1671	1680	1689	9 (Riser) + 1689 (U)	45	60

6018-07

Standard Pillows: N/A **Finish Req:** Y
Standard Cushions: High Resiliency 40 **Standard Finish:** N/A
COM: 3.5 yards

Dora Bar Stool

Width: 20.5 **Depth:** 25 **Height:** 46
AH: - **SH:** 30.5 **SD:** 17.5 **IW:** 20.5
Weight: 25 / 30 lbs **Cube:** 19.6

D	E	F	G	H	J	K _{COM}	L	M	N	O	P	Q	R	S	T	U	(# above U) *	S Nail	M Nail
1545	1554	1563	1572	1581	1590	1599	1608	1617	1626	1635	1644	1653	1662	1671	1680	1689	9 (Riser) + 1689 (U)	45	60

6018-40

Standard Pillows: N/A **Finish Req:** Y
Standard Cushions: High Resiliency 40 **Standard Finish:** N/A
COM: 6.5 yards

Dora Settee

Width: 55.5 **Depth:** 29 **Height:** 44
AH: 24 **SH:** 20.75 **SD:** 18.5 **IW:** 50
Weight: 54 / 79 lbs **Cube:** 44.07

D	E	F	G	H	J	K _{COM}	L	M	N	O	P	Q	R	S	T	U	(# above U) *	S Nail	M Nail
2250	2271	2292	2313	2334	2355	2376	2397	2418	2439	2460	2481	2502	2523	2544	2565	2586	21 (Riser) + 2586 (U)	105	120

6019-40

Standard Pillows: N/A **Finish Req:** Y
Standard Cushions: High Resiliency 40 **Standard Finish:** N/A
COM: 6.5 yards
 Standard with contrasting centered stripe application with any fabric.

Dora Settee

Width: 55.5 **Depth:** 29 **Height:** 44
AH: 24 **SH:** 20.75 **SD:** 18.5 **IW:** 50
Weight: 54 / 54 lbs **Cube:** 40.98

D	E	F	G	H	J	K _{COM}	L	M	N	O	P	Q	R	S	T	U	(# above U) *	S Nail	M Nail
2250	2271	2292	2313	2334	2355	2376	2397	2418	2439	2460	2481	2502	2523	2544	2565	2586	21 (Riser) + 2586 (U)	105	120

6022-C6

Standard Pillows: N/A **Finish Req:** Y
Standard Cushions: High Resiliency 40 **Standard Finish:** N/A
COM: 1.5 yards

Gilroy Counter Stool

Width: 24 **Depth:** 24 **Height:** 39.5
AH: 32.5 **SH:** 26.5 **SD:** 19 **IW:** 19.5
Weight: 40 / 45 lbs **Cube:** 15.74

D	E	F	G	H	J	K _{COM}	L	M	N	O	P	Q	R	S	T	U	(# above U) *	S Nail	M Nail
1575	1581	1587	1593	1599	1605	1611	1617	1623	1629	1635	1641	1647	1653	1659	1665	1671	6 (Riser) + 1671 (U)	Std.	N/A

6022-06

Standard Pillows: N/A **Finish Req:** Y
Standard Cushions: High Resiliency 40 **Standard Finish:** N/A
COM: 1.5 yards

Gilroy Bar Stool

Width: 24 **Depth:** 24 **Height:** 43.5
AH: 36.5 **SH:** 30.5 **SD:** 19 **IW:** 19.5
Weight: 35 / 40 lbs **Cube:** 17.77

D	E	F	G	H	J	K _{COM}	L	M	N	O	P	Q	R	S	T	U	(# above U) *	S Nail	M Nail
1560	1566	1572	1578	1584	1590	1596	1602	1608	1614	1620	1626	1632	1638	1644	1650	1656	6 (Riser) + 1656 (U)	Std.	N/A

6028-A2

Standard Pillows: N/A **Finish Req:** Y
Standard Cushions: High Resiliency 35 **Standard Finish:** N/A
COM: 2.75 yards

Glenwood Occasional Chair

Width: 24.5 **Depth:** 24.5 **Height:** 35
AH: 26 **SH:** 20 **SD:** 18 **IW:** 19
Weight: 30 / 35 lbs **Cube:** 21.65

D	E	F	G	H	J	K _{COM}	L	M	N	O	P	Q	R	S	T	U	(# above U) *	S Nail	M Nail
1650	1659	1668	1677	1686	1695	1704	1713	1722	1731	1740	1749	1758	1767	1776	1785	1794	9 (Riser) + 1794 (U)	45	60

UPHOLSTERY

6028-01

Standard Pillows: N/A Finish Req: Y
 Standard Cushions: High Resiliency 35 Standard Finish: N/A
 COM: 2.75 yards

Glenwood Occasional Chair

Width: 24.5 Depth: 24.5 Height: 35
 AH: 26 SH: 20 SD: 18 IW: 19
 Weight: 30 / 35 lbs Cube: 15.74

D	E	F	G	H	J	K COM	L	M	N	O	P	Q	R	S	T	U	(# above U) *	S Nail	M Nail
1605	1614	1623	1632	1641	1650	1659	1668	1677	1686	1695	1704	1713	1722	1731	1740	1749	9 (Riser) + 1749 (U)	45	60

6029-A2

Standard Pillows: N/A Finish Req: Y
 Standard Cushions: High Resiliency 40 Standard Finish: N/A
 COM: 3.25 yards

Brayden Occasional Chair

Width: 27 Depth: 29 Height: 31
 AH: 26 SH: 18 SD: 21 IW: 24.5
 Weight: 32 / 45 lbs Cube: 21.65

D	E	F	G	H	J	K COM	L	M	N	O	P	Q	R	S	T	U	(# above U) *	S Nail	M Nail
1725	1740	1755	1770	1785	1800	1815	1830	1845	1860	1875	1890	1905	1920	1935	1950	1965	15 (Riser) + 1965 (U)	N/A	N/A

6029-A4

Standard Pillows: N/A Finish Req: Y
 Standard Cushions: High Resiliency 40 Standard Finish: N/A
 COM: 3.25 yards

Brayden Occasional Chair

Width: 27 Depth: 29 Height: 31
 AH: 26 SH: 18 SD: 21 IW: 24.5
 Weight: 32 / 45 lbs Cube: 23.89

D	E	F	G	H	J	K COM	L	M	N	O	P	Q	R	S	T	U	(# above U) *	S Nail	M Nail
1770	1785	1800	1815	1830	1845	1860	1875	1890	1905	1920	1935	1950	1965	1980	1995	2010	15 (Riser) + 2010 (U)	N/A	N/A

6029-01

Standard Pillows: N/A Finish Req: Y
 Standard Cushions: High Resiliency 40 Standard Finish: N/A
 COM: 3.25 yards

Brayden Occasional Chair

Width: 27 Depth: 29 Height: 31
 AH: 26 SH: 18 SD: 21 IW: 24.5
 Weight: 32 / 45 lbs Cube: 23.89

D	E	F	G	H	J	K COM	L	M	N	O	P	Q	R	S	T	U	(# above U) *	S Nail	M Nail
1680	1695	1710	1725	1740	1755	1770	1785	1800	1815	1830	1845	1860	1875	1890	1905	1920	15 (Riser) + 1920 (U)	N/A	N/A

6046-A2

Standard Pillows: N/A Finish Req: Y
 Standard Cushions: High Resiliency 40 Standard Finish: N/A
 COM: 3.25 yards

Gresham Occasional Chair

Width: 28.5 Depth: 24.5 Height: 33
 AH: 26 SH: 20 SD: 19 IW: 20
 Weight: 25 / 55 lbs Cube: 21.65

D	E	F	G	H	J	K COM	L	M	N	O	P	Q	R	S	T	U	(# above U) *	S Nail	M Nail
1761	1770	1779	1788	1797	1806	1815	1824	1833	1842	1851	1860	1869	1878	1887	1896	1905	9 (Riser) + 1905 (U)	45	N/A

6046-A4

Standard Pillows: N/A Finish Req: Y
 Standard Cushions: High Resiliency 40 Standard Finish: N/A
 COM: 3.25 yards

Gresham Occasional Chair

Width: 28.5 Depth: 24.5 Height: 33
 AH: 26 SH: 20 SD: 19 IW: 20
 Weight: 35 / 40 lbs Cube: 21.65

D	E	F	G	H	J	K COM	L	M	N	O	P	Q	R	S	T	U	(# above U) *	S Nail	M Nail
1797	1806	1815	1824	1833	1842	1851	1860	1869	1878	1887	1896	1905	1914	1923	1932	1941	9 (Riser) + 1941 (U)	45	N/A

6046-01

Standard Pillows: N/A Finish Req: Y
 Standard Cushions: High Resiliency 40 Standard Finish: N/A
 COM: 3.25 yards

Gresham Occasional Chair

Width: 28.5 Depth: 24.5 Height: 33
 AH: 26 SH: 20 SD: 19 IW: 20
 Weight: 25 / 30 lbs Cube: 21.65

D	E	F	G	H	J	K COM	L	M	N	O	P	Q	R	S	T	U	(# above U) *	S Nail	M Nail
1725	1734	1743	1752	1761	1770	1779	1788	1797	1806	1815	1824	1833	1842	1851	1860	1869	9 (Riser) + 1869 (U)	45	N/A

UPHOLSTERY

6048-04

Kathleen Arm Chair

Standard Pillows: N/A **Finish Req:** N
Standard Cushions: High Resiliency 40 **Standard Finish:** traditional
COM: 7.5 yards

Width: 24.5 **Depth:** 29.5 **Height:** 44.5
AH: 24.5 **SH:** 20 **SD:** 18 **IW:** 19
Weight: 40 / 55 lbs **Cube:** 24.14

D	E	F	G	H	J	K _{COM}	L	M	N	O	P	Q	R	S	T	U	(# above U) *	S Nail	M Nail
1800	1824	1848	1872	1896	1920	1944	1968	1992	2016	2040	2064	2088	2112	2136	2160	2184	24 (Riser) + 2184 (U)	45	N/A

6049-05

Kathleen Side Chair

Standard Pillows: N/A **Finish Req:** N
Standard Cushions: High Resiliency 40 **Standard Finish:** traditional
COM: 5.25 yards
 Standard with contrasting centered stripe application with any fabric.

Width: 21 **Depth:** 29.5 **Height:** 44.5
AH: - **SH:** 20 **SD:** 18 **IW:** 19
Weight: 30 / 41 lbs **Cube:** 17.77

D	E	F	G	H	J	K _{COM}	L	M	N	O	P	Q	R	S	T	U	(# above U) *	S Nail	M Nail
1785	1809	1833	1857	1881	1905	1929	1953	1977	2001	2025	2049	2073	2097	2121	2145	2169	24 (Riser) + 2169 (U)	45	N/A

6052-01

Jennings Occasional Chair

Standard Pillows: N/A **Finish Req:** Y
Standard Cushions: High Resiliency 30 **Standard Finish:** N/A
COM: 3.25 yards

Width: 30.5 **Depth:** 29 **Height:** 29.5
AH: 24 **SH:** 17.5 **SD:** 22.5 **IW:** 26
Weight: 25 / 30 lbs **Cube:** 23.89

D	E	F	G	H	J	K _{COM}	L	M	N	O	P	Q	R	S	T	U	(# above U) *	S Nail	M Nail
1575	1584	1593	1602	1611	1620	1629	1638	1647	1656	1665	1674	1683	1692	1701	1710	1719	9 (Riser) + 1719 (U)	45	60

6053-01

Lindale Occasional Chair

Standard Pillows: N/A **Finish Req:** Y
Standard Cushions: High Resiliency 40 **Standard Finish:** N/A
COM: 3.5 yards

Width: 23 **Depth:** 24 **Height:** 37.5
AH: 24.5 **SH:** 21 **SD:** 19 **IW:** 20
Weight: 30 / 35 lbs **Cube:** 15.74

D	E	F	G	H	J	K _{COM}	L	M	N	O	P	Q	R	S	T	U	(# above U) *	S Nail	M Nail
1575	1587	1599	1611	1623	1635	1647	1659	1671	1683	1695	1707	1719	1731	1743	1755	1767	12 (Riser) + 1767 (U)	N/A	N/A

6062-01

Lockhart Occasional Chair

Standard Pillows: N/A **Finish Req:** Y
Standard Cushions: High Resiliency 40 **Standard Finish:** N/A
COM: 3.75 yards

Width: 25.5 **Depth:** 26 **Height:** 35.5
AH: 24.5 **SH:** 19 **SD:** 19 **IW:** 19
Weight: 35 / 40 lbs **Cube:** 21.65

D	E	F	G	H	J	K _{COM}	L	M	N	O	P	Q	R	S	T	U	(# above U) *	S Nail	M Nail
1545	1557	1569	1581	1593	1605	1617	1629	1641	1653	1665	1677	1689	1701	1713	1725	1737	12 (Riser) + 1737 (U)	45	60

6063-35

Jordan Office Swivel Chair

Standard Pillows: N/A **Finish Req:** Y
Standard Cushions: High Resiliency 40 **Standard Finish:** N/A
COM: 3.5 yards
 Standard with a gas lift.

Width: 26 **Depth:** 28 **Height:** 36
AH: - **SH:** - **SD:** 18 **IW:** 22
Weight: 30 / 35 lbs **Cube:** 21.65

D	E	F	G	H	J	K _{COM}	L	M	N	O	P	Q	R	S	T	U	(# above U) *	S Nail	M Nail
1680	1689	1698	1707	1716	1725	1734	1743	1752	1761	1770	1779	1788	1797	1806	1815	1824	9 (Riser) + 1824 (U)	45	60

6064-01

Laurens Occasional Chair

Standard Pillows: N/A **Finish Req:** Y
Standard Cushions: High Resiliency 30 **Standard Finish:** N/A
COM: 4 yards

Width: 25.5 **Depth:** 28.5 **Height:** 41
AH: 27.5 **SH:** 20 **SD:** 19 **IW:** 19
Weight: 40 / 50 lbs **Cube:** 21.65

D	E	F	G	H	J	K _{COM}	L	M	N	O	P	Q	R	S	T	U	(# above U) *	S Nail	M Nail
1605	1617	1629	1641	1653	1665	1677	1689	1701	1713	1725	1737	1749	1761	1773	1785	1797	12 (Riser) + 1797 (U)	45	60

UPHOLSTERY

6068-A4

Keller Arm Chair

Standard Pillows: N/A Finish Req: Y
 Standard Cushions: High Resiliency 40 Standard Finish: N/A
 COM: 2 yards

Width: 23.5 Depth: 24 Height: 31.5
 AH: 24.5 SH: 19.5 SD: 20.5 IW: 20
 Weight: 30 / 35 lbs Cube: 15.74

D	E	F	G	H	J	K _{COM}	L	M	N	O	P	Q	R	S	T	U	(# above U) *	S Nail	M Nail
1362	1368	1374	1380	1386	1392	1398	1404	1410	1416	1422	1428	1434	1440	1446	1452	1458	6 (Riser) + 1458 (U)	45	N/A

6068-C6

Keller Counter Stool

Standard Pillows: N/A Finish Req: Y
 Standard Cushions: High Resiliency 40 Standard Finish: N/A
 COM: 2 yards

Width: 22.5 Depth: 22.5 Height: 39
 AH: 32 SH: 26 SD: 19 IW: 19
 Weight: 30 / 40 lbs Cube: 15.74

D	E	F	G	H	J	K _{COM}	L	M	N	O	P	Q	R	S	T	U	(# above U) *	S Nail	M Nail
1455	1461	1467	1473	1479	1485	1491	1497	1503	1509	1515	1521	1527	1533	1539	1545	1551	6 (Riser) + 1551 (U)	45	N/A

6068-04

Keller Arm Chair

Standard Pillows: N/A Finish Req: Y
 Standard Cushions: High Resiliency 40 Standard Finish: N/A
 COM: 2 yards

Width: 23.5 Depth: 24 Height: 31.5
 AH: 24.5 SH: 19.5 SD: 20.5 IW: 20
 Weight: 30 / 35 lbs Cube: 15.74

D	E	F	G	H	J	K _{COM}	L	M	N	O	P	Q	R	S	T	U	(# above U) *	S Nail	M Nail
1290	1296	1302	1308	1314	1320	1326	1332	1338	1344	1350	1356	1362	1368	1374	1380	1386	6 (Riser) + 1386 (U)	45	N/A

6068-06

Keller Bar Stool

Standard Pillows: N/A Finish Req: Y
 Standard Cushions: High Resiliency 40 Standard Finish: N/A
 COM: 2 yards

Width: 22.5 Depth: 22.5 Height: 43
 AH: 36 SH: 30 SD: 19 IW: 19
 Weight: 30 / 35 lbs Cube: 17.77

D	E	F	G	H	J	K _{COM}	L	M	N	O	P	Q	R	S	T	U	(# above U) *	S Nail	M Nail
1455	1461	1467	1473	1479	1485	1491	1497	1503	1509	1515	1521	1527	1533	1539	1545	1551	6 (Riser) + 1551 (U)	45	N/A

6069-C7

Casey Counter Stool

Standard Pillows: N/A Finish Req: Y
 Standard Cushions: High Resiliency 40 Standard Finish: N/A
 COM: 3.25 yards

Width: 21 Depth: 24.5 Height: 41
 AH: - SH: 27 SD: 16.5 IW: 21
 Weight: 26 / 31 lbs Cube: 17.77

D	E	F	G	H	J	K _{COM}	L	M	N	O	P	Q	R	S	T	U	(# above U) *	S Nail	M Nail
1290	1299	1308	1317	1326	1335	1344	1353	1362	1371	1380	1389	1398	1407	1416	1425	1434	9 (Riser) + 1434 (U)	45	60

6069-04

Casey Arm Chair

Standard Pillows: N/A Finish Req: Y
 Standard Cushions: High Resiliency 40 Standard Finish: N/A
 COM: 3.5 yards

Width: 25 Depth: 25.5 Height: 38
 AH: 26 SH: 20 SD: 17.5 IW: 22
 Weight: 30 / 35 lbs Cube: 15.74

D	E	F	G	H	J	K _{COM}	L	M	N	O	P	Q	R	S	T	U	(# above U) *	S Nail	M Nail
1290	1299	1308	1317	1326	1335	1344	1353	1362	1371	1380	1389	1398	1407	1416	1425	1434	9 (Riser) + 1434 (U)	45	60

6069-05

Casey Side Chair

Standard Pillows: N/A Finish Req: Y
 Standard Cushions: High Resiliency 40 Standard Finish: N/A
 COM: 3.5 yards

Width: 22.5 Depth: 25.5 Height: 38
 AH: - SH: 20 SD: 17.5 IW: -
 Weight: 25 / 30 lbs Cube: 15.74

D	E	F	G	H	J	K _{COM}	L	M	N	O	P	Q	R	S	T	U	(# above U) *	S Nail	M Nail
1245	1254	1263	1272	1281	1290	1299	1308	1317	1326	1335	1344	1353	1362	1371	1380	1389	9 (Riser) + 1389 (U)	45	60

UPHOLSTERY

6069-07

Standard Pillows: N/A Finish Req: Y
 Standard Cushions: High Resiliency 40 Standard Finish: N/A
 COM: 3.25 yards

Casey Bar Stool

Width: 21 Depth: 24.5 Height: 45
 AH: - SH: 31 SD: 16.5 IW: 21
 Weight: 26 / 39 lbs Cube: 19.6

D	E	F	G	H	J	K _{COM}	L	M	N	O	P	Q	R	S	T	U	(# above U) *	S Nail	M Nail
1290	1299	1308	1317	1326	1335	1344	1353	1362	1371	1380	1389	1398	1407	1416	1425	1434	9 (Riser) + 1434 (U)	45	60

6079-A2

Standard Pillows: N/A Finish Req: Y
 Standard Cushions: High Resiliency 40 Standard Finish: N/A
 COM: 3.5 yards

Brent Occasional Chair

Width: 27 Depth: 27 Height: 31.5
 AH: 26.5 SH: 18.5 SD: 18.5 IW: 19.5
 Weight: 31 / 36 lbs Cube: 21.65

D	E	F	G	H	J	K _{COM}	L	M	N	O	P	Q	R	S	T	U	(# above U) *	S Nail	M Nail
1656	1665	1674	1683	1692	1701	1710	1719	1728	1737	1746	1755	1764	1773	1782	1791	1800	9 (Riser) + 1800 (U)	60	75

6079-A4

Standard Pillows: N/A Finish Req: Y
 Standard Cushions: High Resiliency 40 Standard Finish: N/A
 COM: 3.5 yards

Brent Occasional Chair

Width: 27 Depth: 27 Height: 31.5
 AH: 26.5 SH: 18.5 SD: 18.5 IW: 19.5
 Weight: 35 / 45 lbs Cube: 21.65

D	E	F	G	H	J	K _{COM}	L	M	N	O	P	Q	R	S	T	U	(# above U) *	S Nail	M Nail
1692	1701	1710	1719	1728	1737	1746	1755	1764	1773	1782	1791	1800	1809	1818	1827	1836	9 (Riser) + 1836 (U)	60	75

6079-01

Standard Pillows: N/A Finish Req: Y
 Standard Cushions: High Resiliency 40 Standard Finish: N/A
 COM: 3.5 yards

Brent Occasional Chair

Width: 27 Depth: 27 Height: 31.5
 AH: 26.5 SH: 18.5 SD: 18.5 IW: 19.5
 Weight: 35 / 45 lbs Cube: 21.65

D	E	F	G	H	J	K _{COM}	L	M	N	O	P	Q	R	S	T	U	(# above U) *	S Nail	M Nail
1620	1629	1638	1647	1656	1665	1674	1683	1692	1701	1710	1719	1728	1737	1746	1755	1764	9 (Riser) + 1764 (U)	60	75

6080-A2

Standard Pillows: N/A Finish Req: Y
 Standard Cushions: High Resiliency 40 Standard Finish: N/A
 COM: 3.25 yards

Danbury Barrel Occasional Chair

Width: 26 Depth: 25 Height: 33
 AH: 26 SH: 19.5 SD: 20 IW: 21.5
 Weight: 50 / 55 lbs Cube: 21.65

D	E	F	G	H	J	K _{COM}	L	M	N	O	P	Q	R	S	T	U	(# above U) *	S Nail	M Nail
1566	1575	1584	1593	1602	1611	1620	1629	1638	1647	1656	1665	1674	1683	1692	1701	1710	9 (Riser) + 1710 (U)	Std.	N/A

6080-A4

Standard Pillows: N/A Finish Req: Y
 Standard Cushions: High Resiliency 40 Standard Finish: N/A
 COM: 3.25 yards

Danbury Occasional Chair

Width: 26 Depth: 25 Height: 33
 AH: 26 SH: 19.5 SD: 20 IW: 21.5
 Weight: 50 / 55 lbs Cube: 21.65

D	E	F	G	H	J	K _{COM}	L	M	N	O	P	Q	R	S	T	U	(# above U) *	S Nail	M Nail
1602	1611	1620	1629	1638	1647	1656	1665	1674	1683	1692	1701	1710	1719	1728	1737	1746	9 (Riser) + 1746 (U)	Std.	N/A

6080-01

Standard Pillows: N/A Finish Req: Y
 Standard Cushions: High Resiliency 40 Standard Finish: N/A
 COM: 3.25 yards

Danbury Occasional Chair

Width: 26 Depth: 25 Height: 33.5
 AH: 26 SH: 19.5 SD: 20 IW: 21.5
 Weight: 50 / 55 lbs Cube: 21.65

D	E	F	G	H	J	K _{COM}	L	M	N	O	P	Q	R	S	T	U	(# above U) *	S Nail	M Nail
1530	1539	1548	1557	1566	1575	1584	1593	1602	1611	1620	1629	1638	1647	1656	1665	1674	9 (Riser) + 1674 (U)	Std.	N/A

UPHOLSTERY

6085-01

Standard Pillows: N/A **Finish Req:** Y
Standard Cushions: High Resiliency 40 **Standard Finish:** N/A
COM: 3.75 yards

Devin Lounge Chair

Width: 29.5 **Depth:** 33 **Height:** 35.5
AH: 24 **SH:** 19 **SD:** 21 **IW:** 20
Weight: 43 / 57 lbs **Cube:** 29.69

D	E	F	G	H	J	K COM	L	M	N	O	P	Q	R	S	T	U	(# above U) *	S Nail	M Nail
2100	2112	2124	2136	2148	2160	2172	2184	2196	2208	2220	2232	2244	2256	2268	2280	2292	12 (Riser) + 2292 (U)	N/A	N/A

6085-1N

Standard Pillows: N/A **Finish Req:** N
Standard Cushions: High Resiliency 40 **Standard Finish:** Nickel
COM: 3.75 yards
Features Swivel Nickel Base with Casters

Devin Task Chair

Width: 26.5 **Depth:** 31 **Height:** 36.25
AH: 25.25 **SH:** 20 **SD:** 22 **IW:** 20
Weight: 39 / 54 lbs **Cube:** 23.89

D	E	F	G	H	J	K COM	L	M	N	O	P	Q	R	S	T	U	(# above U) *	S Nail	M Nail
1980	1992	2004	2016	2028	2040	2052	2064	2076	2088	2100	2112	2124	2136	2148	2160	2172	12 (Riser) + 2172 (U)	N/A	N/A

6085-2N

Standard Pillows: N/A **Finish Req:** N
Standard Cushions: High Resiliency 40 **Standard Finish:** Nickel
COM: 3.75 yards
Features Stationary Nickel Plated Base with a gas cylinder.

Devin Swivel Chair

Width: 26.5 **Depth:** 31 **Height:** 34.75
AH: 23.75 **SH:** 18.5 **SD:** 22 **IW:** 20
Weight: 39 / 52 lbs **Cube:** 23.89

D	E	F	G	H	J	K COM	L	M	N	O	P	Q	R	S	T	U	(# above U) *	S Nail	M Nail
1980	1992	2004	2016	2028	2040	2052	2064	2076	2088	2100	2112	2124	2136	2148	2160	2172	12 (Riser) + 2172 (U)	N/A	N/A

6086-04

Standard Pillows: N/A **Finish Req:** Y
Standard Cushions: High Resiliency 40 **Standard Finish:** N/A
COM: 6.5 yards

Reed Arm Chair

Width: 24.5 **Depth:** 29 **Height:** 44
AH: 24 **SH:** 21 **SD:** 18.5 **IW:** 19
Weight: 41 / 56 lbs **Cube:** 27.3

D	E	F	G	H	J	K COM	L	M	N	O	P	Q	R	S	T	U	(# above U) *	S Nail	M Nail
1785	1803	1821	1839	1857	1875	1893	1911	1929	1947	1965	1983	2001	2019	2037	2055	2073	18 (Riser) + 2073 (U)	45	N/A

6086-05

Standard Pillows: N/A **Finish Req:** Y
Standard Cushions: High Resiliency 40 **Standard Finish:** N/A
COM: 4.75 yards

Reed Side Chair

Width: 21 **Depth:** 29 **Height:** 44
AH: - **SH:** 21 **SD:** 18.5 **IW:** -
Weight: 31 / 44 lbs **Cube:** 21.65

D	E	F	G	H	J	K COM	L	M	N	O	P	Q	R	S	T	U	(# above U) *	S Nail	M Nail
1680	1695	1710	1725	1740	1755	1770	1785	1800	1815	1830	1845	1860	1875	1890	1905	1920	15 (Riser) + 1920 (U)	45	N/A

6087-01

Standard Pillows: N/A **Finish Req:** Y
Standard Cushions: High Resiliency 40 **Standard Finish:** N/A
COM: 4.75 yards

Nina Lounge Chair

Width: 29.25 **Depth:** 29.25 **Height:** 34.25
AH: 24.75 **SH:** 19.75 **SD:** 20.5 **IW:** 22.5
Weight: 40 / 40 lbs **Cube:** 16.95

D	E	F	G	H	J	K COM	L	M	N	O	P	Q	R	S	T	U	(# above U) *	S Nail	M Nail
2175	2190	2205	2220	2235	2250	2265	2280	2295	2310	2325	2340	2355	2370	2385	2400	2415	15 (Riser) + 2415 (U)	90	N/A

6088-01

Standard Pillows: N/A **Finish Req:** Y
Standard Cushions: High Resiliency 35 **Standard Finish:** N/A
COM: 3.25 yards

Lynnhaven Occasional Chair

Width: 26.5 **Depth:** 29.5 **Height:** 32.5
AH: 22 **SH:** 19 **SD:** 22 **IW:** 21
Weight: 29 / 42 lbs **Cube:** 21.65

D	E	F	G	H	J	K COM	L	M	N	O	P	Q	R	S	T	U	(# above U) *	S Nail	M Nail
2070	2082	2094	2106	2118	2130	2142	2154	2166	2178	2190	2202	2214	2226	2238	2250	2262	12 (Riser) + 2262 (U)	N/A	N/A

UPHOLSTERY

6090-01

Lana Occasional Chair

Standard Pillows: N/A Finish Req: Y
 Standard Cushions: High Resiliency 50 Standard Finish: N/A
 COM: 3.5 yards
 Features a clean out back detail.

Width: 28.5 Depth: 24.5 Height: 30.5
 AH: 23 SH: 18.5 SD: 22 IW: 21
 Weight: 37 / 37 lbs Cube: 12.32

D	E	F	G	H	J	K COM	L	M	N	O	P	Q	R	S	T	U	(# above U) *	S Nail	M Nail
1875	1887	1899	1911	1923	1935	1947	1959	1971	1983	1995	2007	2019	2031	2043	2055	2067	12 (Riser) + 2067 (U)	90	N/A

6092-A2

Fiona Occasional Chair

Standard Pillows: N/A Finish Req: Y
 Standard Cushions: High Resiliency 40 Standard Finish: N/A
 COM: 3.75 yards

Width: 25 Depth: 28.25 Height: 34.5
 AH: 24 SH: 19.25 SD: 19 IW: 18.5
 Weight: 51 / 51 lbs Cube: 14.1

D	E	F	G	H	J	K COM	L	M	N	O	P	Q	R	S	T	U	(# above U) *	S Nail	M Nail
1950	1962	1974	1986	1998	2010	2022	2034	2046	2058	2070	2082	2094	2106	2118	2130	2142	12 (Riser) + 2142 (U)	90	105

6092-A4

Fiona Occasional Chair

Standard Pillows: N/A Finish Req: Y
 Standard Cushions: High Resiliency 40 Standard Finish: N/A
 COM: 3.75 yards

Width: 25 Depth: 28.25 Height: 34.5
 AH: 24 SH: 19.25 SD: 19 IW: 18.5
 Weight: 51 / 51 lbs Cube: 21.65

D	E	F	G	H	J	K COM	L	M	N	O	P	Q	R	S	T	U	(# above U) *	S Nail	M Nail
1986	1998	2010	2022	2034	2046	2058	2070	2082	2094	2106	2118	2130	2142	2154	2166	2178	12 (Riser) + 2178 (U)	90	105

6092-01

Fiona Occasional Chair

Standard Pillows: N/A Finish Req: Y
 Standard Cushions: High Resiliency 40 Standard Finish: N/A
 COM: 3.75 yards

Width: 25 Depth: 28.25 Height: 34.5
 AH: 24 SH: 19.25 SD: 19 IW: 18.5
 Weight: 51 / 51 lbs Cube: 14.1

D	E	F	G	H	J	K COM	L	M	N	O	P	Q	R	S	T	U	(# above U) *	S Nail	M Nail
1914	1926	1938	1950	1962	1974	1986	1998	2010	2022	2034	2046	2058	2070	2082	2094	2106	12 (Riser) + 2106 (U)	90	105

6096-01

Callie Occasional Chair

Standard Pillows: N/A Finish Req: Y
 Standard Cushions: High Resiliency 30 Standard Finish: N/A
 COM: 4.75 yards

Width: 26.5 Depth: 31.5 Height: 35
 AH: 25 SH: 20 SD: 22 IW: 20
 Weight: 43 / 56 lbs Cube: 23.89

D	E	F	G	H	J	K COM	L	M	N	O	P	Q	R	S	T	U	(# above U) *	S Nail	M Nail
2100	2115	2130	2145	2160	2175	2190	2205	2220	2235	2250	2265	2280	2295	2310	2325	2340	15 (Riser) + 2340 (U)	75	N/A

6099-01

Kingston Occasional Chair

Standard Pillows: N/A Finish Req: Y
 Standard Cushions: High Resiliency 40 Standard Finish: N/A
 COM: 1.75 yards

Width: 23 Depth: 23.5 Height: 34.5
 AH: 26 SH: 20 SD: 18.5 IW: 19
 Weight: 25 / 30 lbs Cube: 15.74

D	E	F	G	H	J	K COM	L	M	N	O	P	Q	R	S	T	U	(# above U) *	S Nail	M Nail
1200	1206	1212	1218	1224	1230	1236	1242	1248	1254	1260	1266	1272	1278	1284	1290	1296	6 (Riser) + 1296 (U)	N/A	N/A

6100-A2

Harlow Arm Chair

Two Casters

Width: 23 Depth: 24 Height: 36.5
 AH: 24 SH: 19.5 SD: 19 IW: 20
 Weight: 21 / 21 lbs Cube: 11.65

Standard Pillows: N/A Finish Req: Y
 Standard Cushions: High Resiliency 40 Standard Finish: N/A
 COM: 2 yards
 Features natural cane accents that was handwoven using the peel of natural rattan. As with any natural product, natures imperfections and hallmarks will be present in the cane materials. Cane is a handcrafted product with artisanal origins dating back to the Ancient Egyptians.

D	E	F	G	H	J	K COM	L	M	N	O	P	Q	R	S	T	U	(# above U) *	S Nail	M Nail
1161	1167	1173	1179	1185	1191	1197	1203	1209	1215	1221	1227	1233	1239	1245	1251	1257	6 (Riser) + 1257 (U)	N/A	N/A

UPHOLSTERY

6100-C7

Harlow Counter Stool

Width: 19.5 Depth: 23.5 Height: 38.75
 AH: - SH: 24.5 SD: 19 IW: 19.5
 Weight: 30 / 30 lbs Cube: 10.27

Standard Pillows: N/A Finish Req: Y
 Standard Cushions: High Resiliency 40 Standard Finish: N/A
 COM: 2 yards

Features natural cane accents that was handwoven using the peel of natural rattan. As with any natural product, natures imperfections and hallmarks will be present in the cane materials. Cane is a handcrafted product with artisanal origins dating back to the Ancient Egyptians.

D	E	F	G	H	J	K COM	L	M	N	O	P	Q	R	S	T	U	(# above U) *	S Nail	M Nail
1170	1176	1182	1188	1194	1200	1206	1212	1218	1224	1230	1236	1242	1248	1254	1260	1266	6 (Riser) + 1266 (U)	N/A	N/A

6100-04

Harlow Arm Chair

Width: 23 Depth: 24 Height: 36.5
 AH: 24 SH: 19.5 SD: 19 IW: 20
 Weight: 21 / 21 lbs Cube: 11.65

Standard Pillows: N/A Finish Req: Y
 Standard Cushions: High Resiliency 40 Standard Finish: N/A
 COM: 2 yards

Features natural cane accents that was handwoven using the peel of natural rattan. As with any natural product, natures imperfections and hallmarks will be present in the cane materials. Cane is a handcrafted product with artisanal origins dating back to the Ancient Egyptians.

D	E	F	G	H	J	K COM	L	M	N	O	P	Q	R	S	T	U	(# above U) *	S Nail	M Nail
1125	1131	1137	1143	1149	1155	1161	1167	1173	1179	1185	1191	1197	1203	1209	1215	1221	6 (Riser) + 1221 (U)	N/A	N/A

6100-05

Harlow Side Chair

Width: 20 Depth: 24 Height: 35.25
 AH: - SH: 19.5 SD: 19 IW: 20
 Weight: 16 / 16 lbs Cube: 9.79

Standard Pillows: N/A Finish Req: Y
 Standard Cushions: High Resiliency 40 Standard Finish: N/A
 COM: 2 yards

Features natural cane accents that was handwoven using the peel of natural rattan. As with any natural product, natures imperfections and hallmarks will be present in the cane materials. Cane is a handcrafted product with artisanal origins dating back to the Ancient Egyptians.

D	E	F	G	H	J	K COM	L	M	N	O	P	Q	R	S	T	U	(# above U) *	S Nail	M Nail
1095	1101	1107	1113	1119	1125	1131	1137	1143	1149	1155	1161	1167	1173	1179	1185	1191	6 (Riser) + 1191 (U)	N/A	N/A

6100-07

Harlow Bar Stool

Width: 19.5 Depth: 23.5 Height: 44.75
 AH: - SH: 30.5 SD: 19 IW: 19.5
 Weight: 30 / 30 lbs Cube: 11.86

Standard Pillows: N/A Finish Req: Y
 Standard Cushions: High Resiliency 40 Standard Finish: N/A
 COM: 2 yards

Features natural cane accents that was handwoven using the peel of natural rattan. As with any natural product, natures imperfections and hallmarks will be present in the cane materials. Cane is a handcrafted product with artisanal origins dating back to the Ancient Egyptians.

D	E	F	G	H	J	K COM	L	M	N	O	P	Q	R	S	T	U	(# above U) *	S Nail	M Nail
1170	1176	1182	1188	1194	1200	1206	1212	1218	1224	1230	1236	1242	1248	1254	1260	1266	6 (Riser) + 1266 (U)	N/A	N/A

6103-31

Sunset Swivel Chair

Width: 30.75 Depth: 32.5 Height: 34.5
 AH: 24.75 SH: 18.75 SD: 23 IW: 22
 Weight: 65 / 65 lbs Cube: 19.95

Standard Pillows: N/A Finish Req: N
 Standard Cushions: Classic Plush Standard Finish: N/A
 COM: 6.75 yards
 Features a clean out design.

D	E	F	G	H	J	K COM	L	M	N	O	P	Q	R	S	T	U	(# above U) *	S Nail	M Nail
2325	2346	2367	2388	2409	2430	2451	2472	2493	2514	2535	2556	2577	2598	2619	2640	2661	21 (Riser) + 2661 (U)	45	N/A

6103-32

Sunset Swivel Glider

Width: 30.75 Depth: 32.5 Height: 34.5
 AH: 24.75 SH: 18.75 SD: 23 IW: 22
 Weight: 65 / 65 lbs Cube: 19.95

Standard Pillows: N/A Finish Req: N
 Standard Cushions: Classic Plush Standard Finish: N/A
 COM: 6.75 yards
 Features a clean out design.

D	E	F	G	H	J	K COM	L	M	N	O	P	Q	R	S	T	U	(# above U) *	S Nail	M Nail
2475	2496	2517	2538	2559	2580	2601	2622	2643	2664	2685	2706	2727	2748	2769	2790	2811	21 (Riser) + 2811 (U)	45	N/A

6196-01

Madison Lounge Chair

Width: 27 Depth: 30.5 Height: 34.5
 AH: 24 SH: 19 SD: 19 IW: 20
 Weight: 41 / 54 lbs Cube: 23.89

Standard Pillows: N/A Finish Req: Y
 Standard Cushions: High Resiliency 30 Standard Finish: N/A
 COM: 4.5 yards

D	E	F	G	H	J	K COM	L	M	N	O	P	Q	R	S	T	U	(# above U) *	S Nail	M Nail
1950	1965	1980	1995	2010	2025	2040	2055	2070	2085	2100	2115	2130	2145	2160	2175	2190	15 (Riser) + 2190 (U)	120	N/A

UPHOLSTERY

6196-50

Standard Pillows: N/A Finish Req: Y
 Standard Cushions: High Resiliency 30 Standard Finish: N/A
 COM: 8.75 yards

Madison Sofa

Width: 86.5 Depth: 30.5 Height: 34.5
 AH: 24 SH: 19 SD: 19 IW: 79.5
 Weight: 96 / 96 lbs Cube: 52.67

D	E	F	G	H	J	K COM	L	M	N	O	P	Q	R	S	T	U	(# above U) *	S Nail	M Nail
2985	3009	3033	3057	3081	3105	3129	3153	3177	3201	3225	3249	3273	3297	3321	3345	3369	24 (Riser) + 3369 (U)	270	N/A

6196-70

Standard Pillows: N/A Finish Req: Y
 Standard Cushions: High Resiliency 30 Standard Finish: N/A
 COM: 6.5 yards

Madison Loveseat

Width: 59 Depth: 30.5 Height: 34.5
 AH: 24 SH: 19 SD: 19 IW: 52
 Weight: 75 / 75 lbs Cube: 35.92

D	E	F	G	H	J	K COM	L	M	N	O	P	Q	R	S	T	U	(# above U) *	S Nail	M Nail
2685	2703	2721	2739	2757	2775	2793	2811	2829	2847	2865	2883	2901	2919	2937	2955	2973	18 (Riser) + 2973 (U)	210	N/A

6197-01

Standard Pillows: N/A Finish Req: Y
 Standard Cushions: High Resiliency 30 Standard Finish: N/A
 COM: 4.5 yards

Norwood Lounge Chair

Width: 26.5 Depth: 28 Height: 31.5
 AH: 24 SH: 19 SD: 18.5 IW: 20.5
 Weight: 35 / 49 lbs Cube: 21.65

D	E	F	G	H	J	K COM	L	M	N	O	P	Q	R	S	T	U	(# above U) *	S Nail	M Nail
2100	2115	2130	2145	2160	2175	2190	2205	2220	2235	2250	2265	2280	2295	2310	2325	2340	15 (Riser) + 2340 (U)	135	N/A

6197-50

Standard Pillows: N/A Finish Req: Y
 Standard Cushions: High Resiliency 30 Standard Finish: N/A
 COM: 9 yards

Norwood Sofa

Width: 80 Depth: 28.25 Height: 31.5
 AH: 25 SH: 18.75 SD: 19 IW: 74
 Weight: 93 / 93 lbs Cube: 41.19

D	E	F	G	H	J	K COM	L	M	N	O	P	Q	R	S	T	U	(# above U) *	S Nail	M Nail
3150	3177	3204	3231	3258	3285	3312	3339	3366	3393	3420	3447	3474	3501	3528	3555	3582	27 (Riser) + 3582 (U)	240	N/A

6197-70

Standard Pillows: N/A Finish Req: Y
 Standard Cushions: High Resiliency 30 Standard Finish: N/A
 COM: 8 yards

Norwood Loveseat

Width: 70 Depth: 28.25 Height: 31.5
 AH: 25 SH: 18.75 SD: 19 IW: 64
 Weight: 80 / 80 lbs Cube: 36.04

D	E	F	G	H	J	K COM	L	M	N	O	P	Q	R	S	T	U	(# above U) *	S Nail	M Nail
2925	2949	2973	2997	3021	3045	3069	3093	3117	3141	3165	3189	3213	3237	3261	3285	3309	24 (Riser) + 3309 (U)	225	N/A

6200-01-2

Standard Pillows: (1) Kidney Finish Req: N
 Standard Cushions: High Resiliency 30 Standard Finish: Nickel
 COM: 4.75 yards

Salinas Lounge Chair

Width: 29.5 Depth: 32 Height: 32
 AH: 24.5 SH: 19 SD: 19 IW: 23
 Weight: 60 / 60 lbs Cube: 17.48

D	E	F	G	H	J	K COM	L	M	N	O	P	Q	R	S	T	U	(# above U) *	S Nail	M Nail
2175	2190	2205	2220	2235	2250	2265	2280	2295	2310	2325	2340	2355	2370	2385	2400	2415	15 (Riser) + 2415 (U)	90	N/A

6200-01-8

Standard Pillows: (1) Kidney Finish Req: N
 Standard Cushions: High Resiliency 30 Standard Finish: Gold
 COM: 4.75 yards

Salinas Lounge Chair

Width: 29.5 Depth: 32 Height: 32
 AH: 24.5 SH: 19 SD: 19 IW: 23
 Weight: 60 / 60 lbs Cube: 17.48

D	E	F	G	H	J	K COM	L	M	N	O	P	Q	R	S	T	U	(# above U) *	S Nail	M Nail
2175	2190	2205	2220	2235	2250	2265	2280	2295	2310	2325	2340	2355	2370	2385	2400	2415	15 (Riser) + 2415 (U)	90	N/A

UPHOLSTERY

6201-01-2

Standard Pillows: N/A Finish Req: N
 Standard Cushions: Ultra Plush Standard Finish: Nickel
 COM: 5.25 yards

Rivoli Lounge Chair

Width: 32 Depth: 33 Height: 30.5
 AH: 23 SH: 19 SD: 23 IW: 22
 Weight: 39 / 45 lbs Cube: 29.69

D	E	F	G	H	J	K _{COM}	L	M	N	O	P	Q	R	S	T	U	(# above U) *	S Nail	M Nail
2385	2400	2415	2430	2445	2460	2475	2490	2505	2520	2535	2550	2565	2580	2595	2610	2625	15 (Riser) + 2625 (U)	N/A	N/A

6201-01-7

Standard Pillows: N/A Finish Req: N
 Standard Cushions: Ultra Plush Standard Finish: Bright Brass
 COM: 5.25 yards

Rivoli Lounge Chair

Width: 32 Depth: 33 Height: 30.5
 AH: 23 SH: 19 SD: 23 IW: 22
 Weight: 39 / 53 lbs Cube: 29.69

D	E	F	G	H	J	K _{COM}	L	M	N	O	P	Q	R	S	T	U	(# above U) *	S Nail	M Nail
2385	2400	2415	2430	2445	2460	2475	2490	2505	2520	2535	2550	2565	2580	2595	2610	2625	15 (Riser) + 2625 (U)	N/A	N/A

6203-01-2

Standard Pillows: N/A Finish Req: N
 Standard Cushions: High Resiliency 40 Standard Finish: Nickel
 COM: 5.5 yards

Capri Lounge Chair

Width: 31.5 Depth: 33 Height: 31
 AH: 23 SH: 17.5 SD: 22 IW: 21.5
 Weight: 47 / 60 lbs Cube: 23.89

D	E	F	G	H	J	K _{COM}	L	M	N	O	P	Q	R	S	T	U	(# above U) *	S Nail	M Nail
2250	2265	2280	2295	2310	2325	2340	2355	2370	2385	2400	2415	2430	2445	2460	2475	2490	15 (Riser) + 2490 (U)	N/A	N/A

6203-01-7

Standard Pillows: N/A Finish Req: N
 Standard Cushions: High Resiliency 40 Standard Finish: Bright Brass
 COM: 5.5 yards

Capri Lounge Chair

Width: 31.5 Depth: 33 Height: 31
 AH: 23 SH: 17.5 SD: 22 IW: 21.5
 Weight: 47 / 61 lbs Cube: 29.69

D	E	F	G	H	J	K _{COM}	L	M	N	O	P	Q	R	S	T	U	(# above U) *	S Nail	M Nail
2250	2265	2280	2295	2310	2325	2340	2355	2370	2385	2400	2415	2430	2445	2460	2475	2490	15 (Riser) + 2490 (U)	N/A	N/A

6204-01-2

Standard Pillows: N/A Finish Req: N
 Standard Cushions: High Resiliency 40 Standard Finish: Nickel
 COM: 5 yards

Verona Lounge Chair

Width: 30.5 Depth: 32.5 Height: 32
 AH: 22 SH: 17.5 SD: 22 IW: 22.5
 Weight: 47 / 61 lbs Cube: 29.69

D	E	F	G	H	J	K _{COM}	L	M	N	O	P	Q	R	S	T	U	(# above U) *	S Nail	M Nail
2250	2265	2280	2295	2310	2325	2340	2355	2370	2385	2400	2415	2430	2445	2460	2475	2490	15 (Riser) + 2490 (U)	N/A	N/A

6204-01-7

Standard Pillows: N/A Finish Req: N
 Standard Cushions: High Resiliency 40 Standard Finish: Bright Brass
 COM: 5 yards

Verona Lounge Chair

Width: 30.5 Depth: 32.5 Height: 32
 AH: 22 SH: 17.5 SD: 22 IW: 22.5
 Weight: 47 / 60 lbs Cube: 29.69

D	E	F	G	H	J	K _{COM}	L	M	N	O	P	Q	R	S	T	U	(# above U) *	S Nail	M Nail
2250	2265	2280	2295	2310	2325	2340	2355	2370	2385	2400	2415	2430	2445	2460	2475	2490	15 (Riser) + 2490 (U)	N/A	N/A

6205-01

Standard Pillows: N/A Finish Req: Y
 Standard Cushions: High Resiliency 40 Standard Finish: N/A
 COM: 3.75 yards

Brixton Occasional Chair

Width: 28.5 Depth: 32 Height: 34.5
 AH: 24.5 SH: 19 SD: 20 IW: 24
 Weight: 30 / 44 lbs Cube: 29.69

D	E	F	G	H	J	K _{COM}	L	M	N	O	P	Q	R	S	T	U	(# above U) *	S Nail	M Nail
1875	1887	1899	1911	1923	1935	1947	1959	1971	1983	1995	2007	2019	2031	2043	2055	2067	12 (Riser) + 2067 (U)	N/A	N/A

UPHOLSTERY

6322-01

LIBBY LANGDON FOR FAIRFIELD
Alana Lounge Chair

Standard Pillows: N/A Finish Req: Y
Standard Cushions: High Resiliency 30 Standard Finish: N/A
COM: 5 yards

Width: 29 Depth: 35.5 Height: 36
AH: 23.5 SH: 18 SD: 23 IW: 21.5
Weight: 38 / 38 lbs Cube: 21.44

D	E	F	G	H	J	K _{COM}	L	M	N	O	P	Q	R	S	T	U	(# above U) *	S Nail	M Nail
2070	2085	2100	2115	2130	2145	2160	2175	2190	2205	2220	2235	2250	2265	2280	2295	2310	15 (Riser) + 2310 (U)	90	N/A

6324-C6

LIBBY LANGDON FOR FAIRFIELD
Boyd Counter Stool

Standard Pillows: N/A Finish Req: Y
Standard Cushions: High Resiliency 40 Standard Finish: N/A
COM: 2.25 yards

Width: 22 Depth: 24.5 Height: 39
AH: 34 SH: 27 SD: 20 IW: 22
Weight: 24 / 24 lbs Cube: 12.16

D	E	F	G	H	J	K _{COM}	L	M	N	O	P	Q	R	S	T	U	(# above U) *	S Nail	M Nail
1650	1659	1668	1677	1686	1695	1704	1713	1722	1731	1740	1749	1758	1767	1776	1785	1794	9 (Riser) + 1794 (U)	N/A	N/A

6324-04

LIBBY LANGDON FOR FAIRFIELD
Boyd Dining Chair

Standard Pillows: N/A Finish Req: Y
Standard Cushions: High Resiliency 40 Standard Finish: N/A
COM: 2.25 yards

Width: 22 Depth: 24.5 Height: 32
AH: - SH: 19 SD: 20 IW: 22
Weight: 19 / 19 lbs Cube: 9.98

D	E	F	G	H	J	K _{COM}	L	M	N	O	P	Q	R	S	T	U	(# above U) *	S Nail	M Nail
1485	1494	1503	1512	1521	1530	1539	1548	1557	1566	1575	1584	1593	1602	1611	1620	1629	9 (Riser) + 1629 (U)	N/A	N/A

6324-06

LIBBY LANGDON FOR FAIRFIELD
Boyd Bar Stool

Standard Pillows: N/A Finish Req: Y
Standard Cushions: High Resiliency 40 Standard Finish: N/A
COM: 2.25 yards

Width: 22 Depth: 24.5 Height: 43
AH: 38 SH: 31 SD: 20 IW: 22
Weight: 25 / 25 lbs Cube: 13.41

D	E	F	G	H	J	K _{COM}	L	M	N	O	P	Q	R	S	T	U	(# above U) *	S Nail	M Nail
1650	1659	1668	1677	1686	1695	1704	1713	1722	1731	1740	1749	1758	1767	1776	1785	1794	9 (Riser) + 1794 (U)	N/A	N/A

6327-01-2

LIBBY LANGDON FOR FAIRFIELD
Cabott Lounge Chair
Nickel Legs

Standard Pillows: N/A Finish Req: N
Standard Cushions: High Resiliency 40 Standard Finish: Nickel
COM: 4.5 yards
Features Nickel Metal Legs.

Width: 33 Depth: 29.75 Height: 32.25
AH: 24 SH: 18.75 SD: 20.5 IW: 22
Weight: 40 / 40 lbs Cube: 18.32

D	E	F	G	H	J	K _{COM}	L	M	N	O	P	Q	R	S	T	U	(# above U) *	S Nail	M Nail
2625	2640	2655	2670	2685	2700	2715	2730	2745	2760	2775	2790	2805	2820	2835	2850	2865	15 (Riser) + 2865 (U)	60	N/A

6327-01-6

LIBBY LANGDON FOR FAIRFIELD
Cabott Lounge Chair
Brushed Brass Legs

Standard Pillows: N/A Finish Req: N
Standard Cushions: High Resiliency 40 Standard Finish: BRUSHED BRASS
COM: 4.5 yards
Features Brushed Brass Metal Legs.

Width: 33 Depth: 29.75 Height: 32.25
AH: 24 SH: 18.75 SD: 20.5 IW: 22
Weight: 40 / 40 lbs Cube: 18.32

D	E	F	G	H	J	K _{COM}	L	M	N	O	P	Q	R	S	T	U	(# above U) *	S Nail	M Nail
2625	2640	2655	2670	2685	2700	2715	2730	2745	2760	2775	2790	2805	2820	2835	2850	2865	15 (Riser) + 2865 (U)	60	N/A

6327-31

LIBBY LANGDON FOR FAIRFIELD
Cabott Swivel Chair

Standard Pillows: N/A Finish Req: N
Standard Cushions: High Resiliency 40 Standard Finish: N/A
COM: 4.5 yards

Width: 33 Depth: 29.75 Height: 32.25
AH: 24 SH: 18.75 SD: 20.5 IW: 22
Weight: 40 / 40 lbs Cube: 18.32

D	E	F	G	H	J	K _{COM}	L	M	N	O	P	Q	R	S	T	U	(# above U) *	S Nail	M Nail
2250	2265	2280	2295	2310	2325	2340	2355	2370	2385	2400	2415	2430	2445	2460	2475	2490	15 (Riser) + 2490 (U)	60	N/A

UPHOLSTERY

6328-01

LIBBY LANGDON FOR FAIRFIELD
Corwin Lounge Chair

Standard Pillows: N/A Finish Req: Y
Standard Cushions: Classic Plush Standard Finish: N/A
COM: 5.25 yards

Width: 32.5 Depth: 25.5 Height: 32.5
AH: 24 SH: 20 SD: 24 IW: 22
Weight: 52 / 52 lbs Cube: 15.58

D	E	F	G	H	J	K _{COM}	L	M	N	O	P	Q	R	S	T	U	(# above U) *	S Nail	M Nail
2385	2400	2415	2430	2445	2460	2475	2490	2505	2520	2535	2550	2565	2580	2595	2610	2625	15 (Riser) + 2625 (U)	N/A	N/A

6329-50

LIBBY LANGDON FOR FAIRFIELD
Francis Sofa

Two boxed backs over two seats

Standard Pillows: (2) 18 x 18, (2) 20 x 20 Finish Req: N
Standard Cushions: Blendown Standard Finish: N/A
COM: 18.75 yards

Width: 97 Depth: 40.25 Height: 35
AH: 25.75 SH: 19.25 SD: 23 IW: 79.75
Weight: 150 / 150 lbs Cube: 79.07

D	E	F	G	H	J	K _{COM}	L	M	N	O	P	Q	R	S	T	U	(# above U) *	S Nail	M Nail
4785	4836	4887	4938	4989	5040	5091	5142	5193	5244	5295	5346	5397	5448	5499	5550	5601	51 (Riser) + 5601 (U)	N/A	N/A

6339-50

LIBBY LANGDON FOR FAIRFIELD
Francis Sofa

Two boxed backs over one seat

Standard Pillows: (2) 18 x 18, (2) 20 x 20 Finish Req: N
Standard Cushions: Blendown Standard Finish: N/A
COM: 18.25 yards

Width: 97 Depth: 40.25 Height: 35
AH: 25.75 SH: 19.25 SD: 23 IW: 79.75
Weight: 150 / 150 lbs Cube: 79.07

D	E	F	G	H	J	K _{COM}	L	M	N	O	P	Q	R	S	T	U	(# above U) *	S Nail	M Nail
4785	4836	4887	4938	4989	5040	5091	5142	5193	5244	5295	5346	5397	5448	5499	5550	5601	51 (Riser) + 5601 (U)	N/A	N/A

6404-01

LIBBY LANGDON FOR FAIRFIELD
Ginny Occasional Chair

Standard Pillows: N/A Finish Req: Y
Standard Cushions: High Resiliency 30 Standard Finish: N/A
COM: 3.75 yards

Width: 27.5 Depth: 27.75 Height: 29
AH: 23.5 SH: 19.25 SD: 21.5 IW: 21.5
Weight: 29 / 42 lbs Cube: 21.65

D	E	F	G	H	J	K _{COM}	L	M	N	O	P	Q	R	S	T	U	(# above U) *	S Nail	M Nail
1875	1887	1899	1911	1923	1935	1947	1959	1971	1983	1995	2007	2019	2031	2043	2055	2067	12 (Riser) + 2067 (U)	75	90

6405-01-6

LIBBY LANGDON FOR FAIRFIELD
Hinsdale Occasional Chair

Standard Pillows: N/A Finish Req: N
Standard Cushions: High Resiliency 30 Standard Finish: BRUSHED BRASS
COM: 3.25 yards

Width: 25.25 Depth: 29 Height: 34
AH: 23.5 SH: 20 SD: 21 IW: 20.25
Weight: 41 / 53 lbs Cube: 23.89

D	E	F	G	H	J	K _{COM}	L	M	N	O	P	Q	R	S	T	U	(# above U) *	S Nail	M Nail
2430	2439	2448	2457	2466	2475	2484	2493	2502	2511	2520	2529	2538	2547	2556	2565	2574	9 (Riser) + 2574 (U)	N/A	N/A

6406-01

LIBBY LANGDON FOR FAIRFIELD
Southampton Occasional Chair

Standard Pillows: N/A Finish Req: Y
Standard Cushions: High Resiliency 30 Standard Finish: N/A
COM: 3.25 yards

Width: 26.5 Depth: 27 Height: 29.5
AH: 25.5 SH: 18.5 SD: 23 IW: 21
Weight: 32 / 42 lbs Cube: 21.65

D	E	F	G	H	J	K _{COM}	L	M	N	O	P	Q	R	S	T	U	(# above U) *	S Nail	M Nail
1875	1884	1893	1902	1911	1920	1929	1938	1947	1956	1965	1974	1983	1992	2001	2010	2019	9 (Riser) + 2019 (U)	75	N/A

6407-01-2

LIBBY LANGDON FOR FAIRFIELD
Lowell Lounge Chair

Standard Pillows: N/A Finish Req: N
Standard Cushions: High Resiliency 40 Standard Finish: Nickel
COM: 4.5 yards

Width: 30.5 Depth: 33.5 Height: 34.25
AH: 19.5 SH: 18.5 SD: 22.5 IW: 22.5
Weight: 52 / 65 lbs Cube: 23.89

D	E	F	G	H	J	K _{COM}	L	M	N	O	P	Q	R	S	T	U	(# above U) *	S Nail	M Nail
2610	2625	2640	2655	2670	2685	2700	2715	2730	2745	2760	2775	2790	2805	2820	2835	2850	15 (Riser) + 2850 (U)	N/A	N/A

UPHOLSTERY

6407-31-2

LIBBY LANGDON FOR FAIRFIELD
Lowell Swivel Chair

Standard Pillows: N/A Finish Req: N
Standard Cushions: High Resiliency 40 Standard Finish: Nickel
COM: 4.75 yards

Width: 30.5 Depth: 33.5 Height: 34.25
AH: 19.5 SH: 18.5 SD: 22.5 IW: 22.5
Weight: 52 / 66 lbs Cube: 29.69

D	E	F	G	H	J	K ^{COM}	L	M	N	O	P	Q	R	S	T	U	(# above U) *	S Nail	M Nail
2775	2790	2805	2820	2835	2850	2865	2880	2895	2910	2925	2940	2955	2970	2985	3000	3015	15 (Riser) + 3015 (U)	N/A	N/A

6410-01

LIBBY LANGDON FOR FAIRFIELD
McAleer Occasional Chair

Standard Pillows: N/A Finish Req: Y
Standard Cushions: High Resiliency 30 Standard Finish: N/A
COM: 3.25 yards

Width: 26.5 Depth: 27.25 Height: 32
AH: 27.5 SH: 19 SD: 21 IW: 25
Weight: 27 / 37 lbs Cube: 21.65

D	E	F	G	H	J	K ^{COM}	L	M	N	O	P	Q	R	S	T	U	(# above U) *	S Nail	M Nail
1725	1734	1743	1752	1761	1770	1779	1788	1797	1806	1815	1824	1833	1842	1851	1860	1869	9 (Riser) + 1869 (U)	60	N/A

6412-01

LIBBY LANGDON FOR FAIRFIELD
Maycroft Occasional Chair

Standard Pillows: N/A Finish Req: Y
Standard Cushions: High Resiliency 30 Standard Finish: N/A
COM: 3.5 yards

Width: 29 Depth: 27 Height: 33.5
AH: 24 SH: 18.5 SD: 19 IW: 22
Weight: 34 / 47 lbs Cube: 23.89

D	E	F	G	H	J	K ^{COM}	L	M	N	O	P	Q	R	S	T	U	(# above U) *	S Nail	M Nail
1800	1809	1818	1827	1836	1845	1854	1863	1872	1881	1890	1899	1908	1917	1926	1935	1944	9 (Riser) + 1944 (U)	75	90

6450-04

LIBBY LANGDON FOR FAIRFIELD
Watermill Arm Chair

Standard Pillows: N/A Finish Req: Y
Standard Cushions: High Resiliency 30 Standard Finish: N/A
COM: 3.5 yards

Width: 23.75 Depth: 28.5 Height: 39
AH: 24.5 SH: 19.5 SD: 19.5 IW: 20
Weight: 23 / 36 lbs Cube: 21.65

D	E	F	G	H	J	K ^{COM}	L	M	N	O	P	Q	R	S	T	U	(# above U) *	S Nail	M Nail
1650	1659	1668	1677	1686	1695	1704	1713	1722	1731	1740	1749	1758	1767	1776	1785	1794	9 (Riser) + 1794 (U)	45	60

6450-05

LIBBY LANGDON FOR FAIRFIELD
Watermill Side Chair

Standard Pillows: N/A Finish Req: Y
Standard Cushions: High Resiliency 30 Standard Finish: N/A
COM: 2.75 yards

Width: 23.75 Depth: 28.5 Height: 39
AH: 19.5 SH: 19.5 SD: 19.5 IW: 20
Weight: 22 / 36 lbs Cube: 21.65

D	E	F	G	H	J	K ^{COM}	L	M	N	O	P	Q	R	S	T	U	(# above U) *	S Nail	M Nail
1620	1629	1638	1647	1656	1665	1674	1683	1692	1701	1710	1719	1728	1737	1746	1755	1764	9 (Riser) + 1764 (U)	45	60

6451-04

LIBBY LANGDON FOR FAIRFIELD
Briarcroft Arm Chair

Standard Pillows: N/A Finish Req: Y
Standard Cushions: High Resiliency 30 Standard Finish: N/A
COM: 3.75 yards

Width: 22 Depth: 26.5 Height: 41.5
AH: 25.5 SH: 20 SD: 18 IW: 18
Weight: 26 / 37 lbs Cube: 17.77

D	E	F	G	H	J	K ^{COM}	L	M	N	O	P	Q	R	S	T	U	(# above U) *	S Nail	M Nail
1920	1932	1944	1956	1968	1980	1992	2004	2016	2028	2040	2052	2064	2076	2088	2100	2112	12 (Riser) + 2112 (U)	60	N/A

6451-05

LIBBY LANGDON FOR FAIRFIELD
Briarcroft Side Chair

Standard Pillows: N/A Finish Req: Y
Standard Cushions: High Resiliency 30 Standard Finish: N/A
COM: 3.75 yards

Width: 22 Depth: 26.5 Height: 41.5
AH: - SH: 20 SD: 18 IW: 18
Weight: 26 / 36 lbs Cube: 15.74

D	E	F	G	H	J	K ^{COM}	L	M	N	O	P	Q	R	S	T	U	(# above U) *	S Nail	M Nail
1890	1902	1914	1926	1938	1950	1962	1974	1986	1998	2010	2022	2034	2046	2058	2070	2082	12 (Riser) + 2082 (U)	60	N/A

UPHOLSTERY

6452-04

LIBBY LANGDON FOR FAIRFIELD
Sayers Arm Chair

Width: 23.5 Depth: 27 Height: 36.5
AH: 25 SH: 20 SD: 18.5 IW: 20.25
Weight: 24 / 37 lbs Cube: 21.65

Standard Pillows: N/A Finish Req: N

Standard Cushions: High Resiliency 40 Standard Finish: Cerused Espresso
COM: 1.5 yards

Features natural cane accents that was handwoven using the peel of natural rattan. As with any natural product, nature's imperfections and hallmarks will be present in the cane materials. Cane is a handcrafted product dating back to the Ancient Egyptians.

D	E	F	G	H	J	K _{COM}	L	M	N	O	P	Q	R	S	T	U	(# above U) *	S Nail	M Nail
1770	1779	1788	1797	1806	1815	1824	1833	1842	1851	1860	1869	1878	1887	1896	1905	1914	9 (Riser) + 1914 (U)	N/A	N/A

6453-04

LIBBY LANGDON FOR FAIRFIELD
Sayers Arm Chair

Width: 23.5 Depth: 27 Height: 36.5
AH: 25 SH: 20 SD: 18.5 IW: 20.25
Weight: 24 / 37 lbs Cube: 21.65

Standard Pillows: N/A Finish Req: Y

Standard Cushions: High Resiliency 40 Standard Finish: N/A
COM: 1.5 yards

Features natural cane accents that was handwoven using the peel of natural rattan. As with any natural product, nature's imperfections and hallmarks will be present in the cane materials. Cane is a handcrafted product dating back to the Ancient Egyptians.

D	E	F	G	H	J	K _{COM}	L	M	N	O	P	Q	R	S	T	U	(# above U) *	S Nail	M Nail
1950	1959	1968	1977	1986	1995	2004	2013	2022	2031	2040	2049	2058	2067	2076	2085	2094	9 (Riser) + 2094 (U)	N/A	N/A

6454-E1

LIBBY LANGDON FOR FAIRFIELD
Stratford EasyClean Occasional Chair

Width: 25.5 Depth: 28.5 Height: 39.5
AH: 25 SH: 18.5 SD: 19.5 IW: 19
Weight: 26 / 36 lbs Cube: 21.65

Standard Pillows: N/A Finish Req: Y

Standard Cushions: High Resiliency 35 Standard Finish: N/A
COM: 3.75 yards

D	E	F	G	H	J	K _{COM}	L	M	N	O	P	Q	R	S	T	U	(# above U) *	S Nail	M Nail
1920	1932	1944	1956	1968	1980	1992	2004	2016	2028	2040	2052	2064	2076	2088	2100	2112	12 (Riser) + 2112 (U)	90	N/A

6454-04

LIBBY LANGDON FOR FAIRFIELD
Stratford Arm Chair

Width: 25.5 Depth: 28.5 Height: 39.5
AH: 25 SH: 18.5 SD: 19.5 IW: 19
Weight: 26 / 39 lbs Cube: 21.65

Standard Pillows: N/A Finish Req: Y

Standard Cushions: High Resiliency 35 Standard Finish: N/A
COM: 3.75 yards

D	E	F	G	H	J	K _{COM}	L	M	N	O	P	Q	R	S	T	U	(# above U) *	S Nail	M Nail
1800	1812	1824	1836	1848	1860	1872	1884	1896	1908	1920	1932	1944	1956	1968	1980	1992	12 (Riser) + 1992 (U)	90	N/A

6455-05

LIBBY LANGDON FOR FAIRFIELD
Hemdale Side Chair

Width: 20 Depth: 26 Height: 36.5
AH: - SH: 19.5 SD: 19 IW: -
Weight: 20 / 30 lbs Cube: 15.74

Standard Pillows: N/A Finish Req: Y

Standard Cushions: High Resiliency 40 Standard Finish: N/A
COM: 2.5 yards

D	E	F	G	H	J	K _{COM}	L	M	N	O	P	Q	R	S	T	U	(# above U) *	S Nail	M Nail
1245	1254	1263	1272	1281	1290	1299	1308	1317	1326	1335	1344	1353	1362	1371	1380	1389	9 (Riser) + 1389 (U)	45	N/A

6456-04

LIBBY LANGDON FOR FAIRFIELD
Thompson Arm Chair

Width: 22.5 Depth: 26.5 Height: 38
AH: 25 SH: 19 SD: 18 IW: 19
Weight: 18 / 28 lbs Cube: 15.74

Standard Pillows: N/A Finish Req: Y

Standard Cushions: High Resiliency 40 Standard Finish: N/A
COM: 2.5 yards

D	E	F	G	H	J	K _{COM}	L	M	N	O	P	Q	R	S	T	U	(# above U) *	S Nail	M Nail
1410	1419	1428	1437	1446	1455	1464	1473	1482	1491	1500	1509	1518	1527	1536	1545	1554	9 (Riser) + 1554 (U)	45	60

6456-05

LIBBY LANGDON FOR FAIRFIELD
Thompson Side Chair

Width: 22.5 Depth: 26.5 Height: 38
AH: - SH: 19 SD: 18 IW: 19
Weight: 16 / 26 lbs Cube: 15.74

Standard Pillows: N/A Finish Req: Y

Standard Cushions: High Resiliency 40 Standard Finish: N/A
COM: 2.5 yards

D	E	F	G	H	J	K _{COM}	L	M	N	O	P	Q	R	S	T	U	(# above U) *	S Nail	M Nail
1320	1329	1338	1347	1356	1365	1374	1383	1392	1401	1410	1419	1428	1437	1446	1455	1464	9 (Riser) + 1464 (U)	45	60

UPHOLSTERY

6500-C7

LIBBY LANGDON FOR FAIRFIELD
Morrison Counter Stool

Standard Pillows: N/A Finish Req: Y
Standard Cushions: High Resiliency 40 Standard Finish: N/A
COM: 2 yards
Standard with Nickel Footrest

Width: 21 Depth: 23 Height: 33
AH: - SH: 24.75 SD: 17 IW: 18.5
Weight: 22 / 22 lbs Cube: 9.22

D	E	F	G	H	J	K ^{COM}	L	M	N	O	P	Q	R	S	T	U	(# above U) *	S Nail	M Nail
1500	1506	1512	1518	1524	1530	1536	1542	1548	1554	1560	1566	1572	1578	1584	1590	1596	6 (Riser) + 1596 (U)	N/A	N/A

6600-10

LIBBY LANGDON FOR FAIRFIELD
Brookwood Bench

Standard Pillows: N/A Finish Req: Y
Standard Cushions: High Resiliency 30 Standard Finish: N/A
COM: 3.5 yards

Width: 51.75 Depth: 15.5 Height: 21.25
AH: 21.25 SH: 20 SD: 15 IW: 50.5
Weight: 29 / 49 lbs Cube: 23.16

D	E	F	G	H	J	K ^{COM}	L	M	N	O	P	Q	R	S	T	U	(# above U) *	S Nail	M Nail
1770	1782	1794	1806	1818	1830	1842	1854	1866	1878	1890	1902	1914	1926	1938	1950	1962	12 (Riser) + 1962 (U)	N/A	N/A

6600-20

LIBBY LANGDON FOR FAIRFIELD
Brookwood Ottoman

Standard Pillows: N/A Finish Req: Y
Standard Cushions: High Resiliency 30 Standard Finish: N/A
COM: 2 yards

Width: 22.75 Depth: 15.5 Height: 21.25
AH: 21.25 SH: 20 SD: 15 IW: 21.5
Weight: 14 / 23 lbs Cube: 10.77

D	E	F	G	H	J	K ^{COM}	L	M	N	O	P	Q	R	S	T	U	(# above U) *	S Nail	M Nail
1275	1284	1293	1302	1311	1320	1329	1338	1347	1356	1365	1374	1383	1392	1401	1410	1419	9 (Riser) + 1419 (U)	N/A	N/A

6602-20

LIBBY LANGDON FOR FAIRFIELD
Dryer Ottoman

Standard Pillows: N/A Finish Req: Y
Standard Cushions: High Resiliency 30 Standard Finish: N/A
COM: 2 yards

Width: 20.5 Depth: 20.5 Height: 20
AH: - SH: - SD: - IW: -
Weight: 23 / 30 lbs Cube: 10.77

D	E	F	G	H	J	K ^{COM}	L	M	N	O	P	Q	R	S	T	U	(# above U) *	S Nail	M Nail
1305	1311	1317	1323	1329	1335	1341	1347	1353	1359	1365	1371	1377	1383	1389	1395	1401	6 (Riser) + 1401 (U)	30	N/A

6602-36

LIBBY LANGDON FOR FAIRFIELD
Dryer Cocktail Ottoman

Standard Pillows: N/A Finish Req: Y
Standard Cushions: High Resiliency 30 Standard Finish: N/A
COM: 3.75 yards

Width: 36.5 Depth: 36.5 Height: 20
AH: - SH: - SD: - IW: -
Weight: 58 / 76 lbs Cube: 21.15

D	E	F	G	H	J	K ^{COM}	L	M	N	O	P	Q	R	S	T	U	(# above U) *	S Nail	M Nail
1755	1770	1785	1800	1815	1830	1845	1860	1875	1890	1905	1920	1935	1950	1965	1980	1995	15 (Riser) + 1995 (U)	45	N/A

6602-44

LIBBY LANGDON FOR FAIRFIELD
Dryer Cocktail Ottoman

Standard Pillows: N/A Finish Req: Y
Standard Cushions: High Resiliency 30 Standard Finish: N/A
COM: 5.25 yards

Width: 44.5 Depth: 44.5 Height: 20
AH: - SH: - SD: - IW: -
Weight: 84 / 104 lbs Cube: 28.93

D	E	F	G	H	J	K ^{COM}	L	M	N	O	P	Q	R	S	T	U	(# above U) *	S Nail	M Nail
2010	2028	2046	2064	2082	2100	2118	2136	2154	2172	2190	2208	2226	2244	2262	2280	2298	18 (Riser) + 2298 (U)	60	N/A

6602-52

LIBBY LANGDON FOR FAIRFIELD
Dryer Cocktail Ottoman

Standard Pillows: N/A Finish Req: Y
Standard Cushions: High Resiliency 30 Standard Finish: N/A
COM: 4.25 yards

Width: 52.5 Depth: 30.5 Height: 20
AH: - SH: - SD: - IW: -
Weight: 72 / 96 lbs Cube: 50.95

D	E	F	G	H	J	K ^{COM}	L	M	N	O	P	Q	R	S	T	U	(# above U) *	S Nail	M Nail
2100	2115	2130	2145	2160	2175	2190	2205	2220	2235	2250	2265	2280	2295	2310	2325	2340	15 (Riser) + 2340 (U)	60	N/A

UPHOLSTERY

6603-20

LIBBY LANGDON FOR FAIRFIELD
Edgemere Cocktail Ottoman

Standard Pillows: N/A Finish Req: Y
Standard Cushions: High Resiliency 40 Standard Finish: N/A
COM: 2.5 yards
Features a biscuit tufted top and Brushed Brass ferrules

Width: 53 Depth: 31 Height: 18
AH: - SH: - SD: - IW: -
Weight: 78 / 102 lbs Cube: 29.1

D	E	F	G	H	J	K _{COM}	L	M	N	O	P	Q	R	S	T	U	(# above U) *	S Nail	M Nail
2010	2022	2034	2046	2058	2070	2082	2094	2106	2118	2130	2142	2154	2166	2178	2190	2202	12 (Riser) + 2202 (U)	45	N/A

6612-20

LIBBY LANGDON FOR FAIRFIELD
Dryer Ottoman

Standard Pillows: N/A Finish Req: Y
Standard Cushions: High Resiliency 30 Standard Finish: N/A
COM: 2 yards

Width: 20.5 Depth: 20.5 Height: 20
AH: - SH: - SD: - IW: -
Weight: 23 / 30 lbs Cube: 10.77

D	E	F	G	H	J	K _{COM}	L	M	N	O	P	Q	R	S	T	U	(# above U) *	S Nail	M Nail
1275	1281	1287	1293	1299	1305	1311	1317	1323	1329	1335	1341	1347	1353	1359	1365	1371	6 (Riser) + 1371 (U)	30	N/A

6612-36

LIBBY LANGDON FOR FAIRFIELD
Dryer Ottoman

Standard Pillows: N/A Finish Req: Y
Standard Cushions: High Resiliency 30 Standard Finish: N/A
COM: 3.75 yards

Width: 36.5 Depth: 36.5 Height: 20
AH: - SH: - SD: - IW: -
Weight: 58 / 58 lbs Cube: 15.41

D	E	F	G	H	J	K _{COM}	L	M	N	O	P	Q	R	S	T	U	(# above U) *	S Nail	M Nail
1710	1722	1734	1746	1758	1770	1782	1794	1806	1818	1830	1842	1854	1866	1878	1890	1902	12 (Riser) + 1902 (U)	45	N/A

6612-44

LIBBY LANGDON FOR FAIRFIELD
Dryer Ottoman

Standard Pillows: N/A Finish Req: Y
Standard Cushions: High Resiliency 30 Standard Finish: N/A
COM: 5.25 yards

Width: 44.5 Depth: 44.5 Height: 20
AH: - SH: - SD: - IW: -
Weight: 84 / 84 lbs Cube: 28.93

D	E	F	G	H	J	K _{COM}	L	M	N	O	P	Q	R	S	T	U	(# above U) *	S Nail	M Nail
1920	1935	1950	1965	1980	1995	2010	2025	2040	2055	2070	2085	2100	2115	2130	2145	2160	15 (Riser) + 2160 (U)	60	N/A

6612-52

LIBBY LANGDON FOR FAIRFIELD
Dryer Ottoman

Standard Pillows: N/A Finish Req: Y
Standard Cushions: High Resiliency 30 Standard Finish: N/A
COM: 4.25 yards

Width: 52.5 Depth: 30.5 Height: 20
AH: - SH: - SD: - IW: -
Weight: 72 / 72 lbs Cube: 18.53

D	E	F	G	H	J	K _{COM}	L	M	N	O	P	Q	R	S	T	U	(# above U) *	S Nail	M Nail
2010	2022	2034	2046	2058	2070	2082	2094	2106	2118	2130	2142	2154	2166	2178	2190	2202	12 (Riser) + 2202 (U)	60	N/A

6651-10-6

LIBBY LANGDON FOR FAIRFIELD
Laurel Bench

Standard Pillows: N/A Finish Req: N
Standard Cushions: High Resiliency 30 Standard Finish: BRUSHED BRASS
COM: 2 yards

Width: 47 Depth: 19.5 Height: 22
AH: - SH: - SD: - IW: -
Weight: 36 / 56 lbs Cube: 15.26

D	E	F	G	H	J	K _{COM}	L	M	N	O	P	Q	R	S	T	U	(# above U) *	S Nail	M Nail
1560	1569	1578	1587	1596	1605	1614	1623	1632	1641	1650	1659	1668	1677	1686	1695	1704	9 (Riser) + 1704 (U)	N/A	N/A

6652-10

LIBBY LANGDON FOR FAIRFIELD
Carrington Bench

Standard Pillows: N/A Finish Req: N
Standard Cushions: High Resiliency 40 Standard Finish: Sheer Dove
COM: 2 yards
Features a polished nickel frame and a wooden magazine rack finished in Sheer Dove.

Width: 48 Depth: 16 Height: 19
AH: - SH: - SD: - IW: -
Weight: 38 / 52 lbs Cube: 23.16

D	E	F	G	H	J	K _{COM}	L	M	N	O	P	Q	R	S	T	U	(# above U) *	S Nail	M Nail
2070	2076	2082	2088	2094	2100	2106	2112	2118	2124	2130	2136	2142	2148	2154	2160	2166	6 (Riser) + 2166 (U)	N/A	N/A

UPHOLSTERY

6653-10-6

LIBBY LANGDON FOR FAIRFIELD
Laurel Ottoman

Standard Pillows: N/A **Finish Req:** N
Standard Cushions: High Resiliency 40 **Standard Finish:** BRUSHED BRASS
COM: 2.75 yards

Width: 62.75 **Depth:** 18.5 **Height:** 22
AH: - **SH:** - **SD:** - **IW:** -
Weight: 33 / 62 lbs **Cube:** 14.77

D	E	F	G	H	J	K _{COM}	L	M	N	O	P	Q	R	S	T	U	(# above U) *	S Nail	M Nail
1635	1644	1653	1662	1671	1680	1689	1698	1707	1716	1725	1734	1743	1752	1761	1770	1779	9 (Riser) + 1779 (U)	N/A	N/A

6765-C7-2

LIBBY LANGDON FOR FAIRFIELD
Jessup Counter Stool

Standard Pillows: N/A **Finish Req:** N
Standard Cushions: High Resiliency 40 **Standard Finish:** Nickel
COM: 2 yards

Width: 19 **Depth:** 19 **Height:** 26.25
AH: - **SH:** 26.25 **SD:** 19 **IW:** 19
Weight: 20 / 30 lbs **Cube:** 15.74

D	E	F	G	H	J	K _{COM}	L	M	N	O	P	Q	R	S	T	U	(# above U) *	S Nail	M Nail
1497	1506	1515	1524	1533	1542	1551	1560	1569	1578	1587	1596	1605	1614	1623	1632	1641	9 (Riser) + 1641 (U)	N/A	N/A

7401-01

Capelli Wing Chair

Standard Pillows: N/A **Finish Req:** Y
Standard Cushions: Classic Plush **Standard Finish:** N/A
COM: 6.75 yards

Width: 34.25 **Depth:** 33.5 **Height:** 47.5
AH: 25.5 **SH:** 22.5 **SD:** 20 **IW:** 21
Weight: 50 / 50 lbs **Cube:** 31.53

D	E	F	G	H	J	K _{COM}	L	M	N	O	P	Q	R	S	T	U	(# above U) *	S Nail	M Nail
2685	2706	2727	2748	2769	2790	2811	2832	2853	2874	2895	2916	2937	2958	2979	3000	3021	21 (Riser) + 3021 (U)	Std.	N/A

7407-E1

Gwynne EasyClean Occasional Chair

Standard Pillows: N/A **Finish Req:** Y
Standard Cushions: High Resiliency 30 **Standard Finish:** N/A
COM: 5.25 yards

Width: 27 **Depth:** 33.75 **Height:** 37.75
AH: 25.25 **SH:** 19 **SD:** 19.5 **IW:** 23.25
Weight: 62 / 76 lbs **Cube:** 29.69

D	E	F	G	H	J	K _{COM}	L	M	N	O	P	Q	R	S	T	U	(# above U) *	S Nail	M Nail
2775	2790	2805	2820	2835	2850	2865	2880	2895	2910	2925	2940	2955	2970	2985	3000	3015	15 (Riser) + 3015 (U)	N/A	N/A

7407-01

Gwynne Occasional Chair

Standard Pillows: N/A **Finish Req:** Y
Standard Cushions: High Resiliency 30 **Standard Finish:** N/A
COM: 5.25 yards

Width: 27 **Depth:** 33.75 **Height:** 37.75
AH: 25.25 **SH:** 19 **SD:** 19.5 **IW:** 23.25
Weight: 62 / 75 lbs **Cube:** 23.89

D	E	F	G	H	J	K _{COM}	L	M	N	O	P	Q	R	S	T	U	(# above U) *	S Nail	M Nail
2775	2790	2805	2820	2835	2850	2865	2880	2895	2910	2925	2940	2955	2970	2985	3000	3015	15 (Riser) + 3015 (U)	N/A	N/A

8060-01

Kirkland Occasional Chair

Standard Pillows: N/A **Finish Req:** Y
Standard Cushions: High Resiliency 40 **Standard Finish:** N/A
COM: 2.5 yards

Width: 28 **Depth:** 31.5 **Height:** 38.5
AH: 25.5 **SH:** 20 **SD:** 23 **IW:** 23
Weight: 30 / 40 lbs **Cube:** 23.83

D	E	F	G	H	J	K _{COM}	L	M	N	O	P	Q	R	S	T	U	(# above U) *	S Nail	M Nail
1410	1419	1428	1437	1446	1455	1464	1473	1482	1491	1500	1509	1518	1527	1536	1545	1554	9 (Riser) + 1554 (U)	45	60

8250-A4

Phillips Occasional Chair

Standard Pillows: N/A **Finish Req:** Y
Standard Cushions: High Resiliency 40 **Standard Finish:** N/A
COM: 2.5 yards

Width: 23.5 **Depth:** 26.5 **Height:** 38.5
AH: 26 **SH:** 18.5 **SD:** 19 **IW:** 18
Weight: 35 / 40 lbs **Cube:** 15.74

D	E	F	G	H	J	K _{COM}	L	M	N	O	P	Q	R	S	T	U	(# above U) *	S Nail	M Nail
1452	1461	1470	1479	1488	1497	1506	1515	1524	1533	1542	1551	1560	1569	1578	1587	1596	9 (Riser) + 1596 (U)	Std.	15

UPHOLSTERY

8250-01

Standard Pillows: N/A **Finish Req:** Y
Standard Cushions: High Resiliency 40 **Standard Finish:** N/A
COM: 2.5 yards

Phillips Occasional Chair

Width: 24.5 **Depth:** 26.5 **Height:** 38.5
AH: 26 **SH:** 18.5 **SD:** 19 **IW:** 18
Weight: 30 / 35 lbs **Cube:** 15.74

D	E	F	G	H	J	K ^{COM}	L	M	N	O	P	Q	R	S	T	U	(# above U) *	S Nail	M Nail
1380	1389	1398	1407	1416	1425	1434	1443	1452	1461	1470	1479	1488	1497	1506	1515	1524	9 (Riser) + 1524 (U)	Std.	15

8321-01

Standard Pillows: N/A **Finish Req:** Y
Standard Cushions: High Resiliency 40 **Standard Finish:** N/A
COM: 3.25 yards

Putnam Side Chair

Width: 22 **Depth:** 24.5 **Height:** 35.5
AH: - **SH:** 19.5 **SD:** 18.5 **IW:** 22
Weight: 25 / 35 lbs **Cube:** 15.74

D	E	F	G	H	J	K ^{COM}	L	M	N	O	P	Q	R	S	T	U	(# above U) *	S Nail	M Nail
1350	1359	1368	1377	1386	1395	1404	1413	1422	1431	1440	1449	1458	1467	1476	1485	1494	9 (Riser) + 1494 (U)	N/A	N/A

8322-01

Standard Pillows: N/A **Finish Req:** Y
Standard Cushions: High Resiliency 40 **Standard Finish:** N/A
COM: 2 yards

Burton Occasional Chair

Width: 25.5 **Depth:** 25.5 **Height:** 33
AH: 26 **SH:** 20.5 **SD:** 20 **IW:** 20.5
Weight: 26 / 36 lbs **Cube:** 15.74

D	E	F	G	H	J	K ^{COM}	L	M	N	O	P	Q	R	S	T	U	(# above U) *	S Nail	M Nail
1395	1401	1407	1413	1419	1425	1431	1437	1443	1449	1455	1461	1467	1473	1479	1485	1491	6 (Riser) + 1491 (U)	Std.	N/A

8326-05

Standard Pillows: N/A **Finish Req:** Y
Standard Cushions: High Resiliency 40 **Standard Finish:** N/A
COM: 1.25 yards

Portsmouth Side Chair

Width: 20 **Depth:** 23 **Height:** 38
AH: - **SH:** 19.5 **SD:** 19 **IW:** -
Weight: 20 / 30 lbs **Cube:** 15.74

D	E	F	G	H	J	K ^{COM}	L	M	N	O	P	Q	R	S	T	U	(# above U) *	S Nail	M Nail
1080	1086	1092	1098	1104	1110	1116	1122	1128	1134	1140	1146	1152	1158	1164	1170	1176	6 (Riser) + 1176 (U)	45	60

8329-C7

Standard Pillows: N/A **Finish Req:** Y
Standard Cushions: High Resiliency 30 **Standard Finish:** N/A
COM: 2.75 yards

Ardmore Counter Stool

Width: 20 **Depth:** 22.5 **Height:** 42
AH: - **SH:** 26.5 **SD:** 17.5 **IW:** -
Weight: 35 / 40 lbs **Cube:** 19.6

D	E	F	G	H	J	K ^{COM}	L	M	N	O	P	Q	R	S	T	U	(# above U) *	S Nail	M Nail
1305	1314	1323	1332	1341	1350	1359	1368	1377	1386	1395	1404	1413	1422	1431	1440	1449	9 (Riser) + 1449 (U)	45	60

8329-01

Standard Pillows: N/A **Finish Req:** Y
Standard Cushions: High Resiliency 30 **Standard Finish:** N/A
COM: 2.75 yards

Ardmore Side Chair

Width: 21 **Depth:** 24.5 **Height:** 36.5
AH: - **SH:** 21.5 **SD:** 21 **IW:** 21
Weight: 25 / 30 lbs **Cube:** 15.74

D	E	F	G	H	J	K ^{COM}	L	M	N	O	P	Q	R	S	T	U	(# above U) *	S Nail	M Nail
1260	1269	1278	1287	1296	1305	1314	1323	1332	1341	1350	1359	1368	1377	1386	1395	1404	9 (Riser) + 1404 (U)	45	60

8329-07

Standard Pillows: N/A **Finish Req:** Y
Standard Cushions: High Resiliency 30 **Standard Finish:** N/A
COM: 2.75 yards

Ardmore Bar Stool

Width: 20 **Depth:** 22.5 **Height:** 45.5
AH: - **SH:** 30 **SD:** 17.5 **IW:** -
Weight: 35 / 40 lbs **Cube:** 19.6

D	E	F	G	H	J	K ^{COM}	L	M	N	O	P	Q	R	S	T	U	(# above U) *	S Nail	M Nail
1305	1314	1323	1332	1341	1350	1359	1368	1377	1386	1395	1404	1413	1422	1431	1440	1449	9 (Riser) + 1449 (U)	45	60

UPHOLSTERY

8339-04

Standard Pillows: N/A **Finish Req:** Y
Standard Cushions: High Resiliency 40 **Standard Finish:** N/A
COM: 1.75 yards

Brookfield Arm Chair

Width: 24.5 **Depth:** 25 **Height:** 39
AH: 28 **SH:** 19.5 **SD:** 18 **IW:** 21
Weight: 30 / 35 lbs **Cube:** 21.65

D	E	F	G	H	J	K _{COM}	L	M	N	O	P	Q	R	S	T	U	(# above U) *	S Nail	M Nail
1485	1491	1497	1503	1509	1515	1521	1527	1533	1539	1545	1551	1557	1563	1569	1575	1581	6 (Riser) + 1581 (U)	N/A	N/A

8363-A4

Standard Pillows: N/A **Finish Req:** Y
Standard Cushions: High Resiliency 40 **Standard Finish:** N/A
COM: 2 yards

Hamlin Arm Chair

Width: 24.5 **Depth:** 24 **Height:** 38
AH: 24.5 **SH:** 20 **SD:** 18.5 **IW:** 20.5
Weight: 30 / 35 lbs **Cube:** 15.74

D	E	F	G	H	J	K _{COM}	L	M	N	O	P	Q	R	S	T	U	(# above U) *	S Nail	M Nail
1308	1314	1320	1326	1332	1338	1344	1350	1356	1362	1368	1374	1380	1386	1392	1398	1404	6 (Riser) + 1404 (U)	45	60

8363-04

Standard Pillows: N/A **Finish Req:** Y
Standard Cushions: High Resiliency 40 **Standard Finish:** N/A
COM: 2 yards

Hamlin Arm Chair

Width: 24.5 **Depth:** 23 **Height:** 38
AH: 24.5 **SH:** 20 **SD:** 17.5 **IW:** 20.5
Weight: 30 / 35 lbs **Cube:** 15.74

D	E	F	G	H	J	K _{COM}	L	M	N	O	P	Q	R	S	T	U	(# above U) *	S Nail	M Nail
1236	1242	1248	1254	1260	1266	1272	1278	1284	1290	1296	1302	1308	1314	1320	1326	1332	6 (Riser) + 1332 (U)	45	60

8363-05

Standard Pillows: N/A **Finish Req:** Y
Standard Cushions: High Resiliency 40 **Standard Finish:** N/A
COM: 2 yards

Hamlin Side Chair

Width: 21.5 **Depth:** 23 **Height:** 37
AH: - **SH:** 19.5 **SD:** 18 **IW:** 21.5
Weight: 25 / 35 lbs **Cube:** 15.74

D	E	F	G	H	J	K _{COM}	L	M	N	O	P	Q	R	S	T	U	(# above U) *	S Nail	M Nail
1170	1176	1182	1188	1194	1200	1206	1212	1218	1224	1230	1236	1242	1248	1254	1260	1266	6 (Riser) + 1266 (U)	45	N/A

8365-A4

Standard Pillows: N/A **Finish Req:** Y
Standard Cushions: High Resiliency 40 **Standard Finish:** N/A
COM: 2 yards

Jefferson Arm Chair

Width: 24.5 **Depth:** 23 **Height:** 38
AH: 24.5 **SH:** 20 **SD:** 17.5 **IW:** 20.5
Weight: 25 / 30 lbs **Cube:** 15.74

D	E	F	G	H	J	K _{COM}	L	M	N	O	P	Q	R	S	T	U	(# above U) *	S Nail	M Nail
1308	1314	1320	1326	1332	1338	1344	1350	1356	1362	1368	1374	1380	1386	1392	1398	1404	6 (Riser) + 1404 (U)	45	60

8368-A2

Standard Pillows: N/A **Finish Req:** Y
Standard Cushions: High Resiliency 40 **Standard Finish:** N/A
COM: 2 yards

Bayfield Arm Chair

Width: 24.5 **Depth:** 27 **Height:** 40
AH: 26.5 **SH:** 20 **SD:** 19 **IW:** 21
Weight: 35 / 40 lbs **Cube:** 21.65

D	E	F	G	H	J	K _{COM}	L	M	N	O	P	Q	R	S	T	U	(# above U) *	S Nail	M Nail
1326	1332	1338	1344	1350	1356	1362	1368	1374	1380	1386	1392	1398	1404	1410	1416	1422	6 (Riser) + 1422 (U)	N/A	N/A

8368-A4

Standard Pillows: N/A **Finish Req:** Y
Standard Cushions: High Resiliency 40 **Standard Finish:** N/A
COM: 2 yards

Bayfield Arm Chair

Width: 24.5 **Depth:** 27 **Height:** 40
AH: 26.5 **SH:** 20 **SD:** 19 **IW:** 21
Weight: 35 / 40 lbs **Cube:** 21.65

D	E	F	G	H	J	K _{COM}	L	M	N	O	P	Q	R	S	T	U	(# above U) *	S Nail	M Nail
1362	1368	1374	1380	1386	1392	1398	1404	1410	1416	1422	1428	1434	1440	1446	1452	1458	6 (Riser) + 1458 (U)	N/A	N/A

UPHOLSTERY

8368-04

Standard Pillows: N/A **Finish Req:** Y
Standard Cushions: High Resiliency 40 **Standard Finish:** N/A
COM: 2 yards

Bayfield Arm Chair

Width: 24.5 **Depth:** 27 **Height:** 40
AH: 26.5 **SH:** 20 **SD:** 19 **IW:** 21
Weight: 35 / 40 lbs **Cube:** 21.65

D	E	F	G	H	J	K _{COM}	L	M	N	O	P	Q	R	S	T	U	(# above U) *	S Nail	M Nail
1290	1296	1302	1308	1314	1320	1326	1332	1338	1344	1350	1356	1362	1368	1374	1380	1386	6 (Riser) + 1386 (U)	N/A	N/A

8378-04

Standard Pillows: N/A **Finish Req:** Y
Standard Cushions: High Resiliency 40 **Standard Finish:** N/A
COM: 2 yards

Mackay Arm Chair

Width: 22 **Depth:** 24 **Height:** 36
AH: 26 **SH:** 19 **SD:** 17.5 **IW:** 19
Weight: 30 / 40 lbs **Cube:** 15.74

D	E	F	G	H	J	K _{COM}	L	M	N	O	P	Q	R	S	T	U	(# above U) *	S Nail	M Nail
1200	1206	1212	1218	1224	1230	1236	1242	1248	1254	1260	1266	1272	1278	1284	1290	1296	6 (Riser) + 1296 (U)	N/A	N/A

8379-01

Standard Pillows: N/A **Finish Req:** Y
Standard Cushions: High Resiliency 40 **Standard Finish:** N/A
COM: 3.5 yards

Ashton Occasional Chair

Width: 25.5 **Depth:** 29.5 **Height:** 38
AH: 23 **SH:** 19.5 **SD:** 19 **IW:** 18
Weight: 35 / 45 lbs **Cube:** 21.65

D	E	F	G	H	J	K _{COM}	L	M	N	O	P	Q	R	S	T	U	(# above U) *	S Nail	M Nail
1650	1659	1668	1677	1686	1695	1704	1713	1722	1731	1740	1749	1758	1767	1776	1785	1794	9 (Riser) + 1794 (U)	60	75

8379-1N

Standard Pillows: N/A **Finish Req:** N
Standard Cushions: High Resiliency 40 **Standard Finish:** Nickel
COM: 3.5 yards
 Features Swivel Nickel Base with Casters

Ashton Task Chair

Width: 25 **Depth:** 27.75 **Height:** 39.75
AH: 21.5 **SH:** 20.75 **SD:** 18.75 **IW:** 18
Weight: 38 / 52 lbs **Cube:** 21.65

D	E	F	G	H	J	K _{COM}	L	M	N	O	P	Q	R	S	T	U	(# above U) *	S Nail	M Nail
1800	1809	1818	1827	1836	1845	1854	1863	1872	1881	1890	1899	1908	1917	1926	1935	1944	9 (Riser) + 1944 (U)	60	75

8379-2N

Standard Pillows: N/A **Finish Req:** N
Standard Cushions: High Resiliency 40 **Standard Finish:** Nickel
COM: 3.5 yards
 Features Stationary Nickel Plated Base with a gas cylinder.

Ashton Swivel Chair

Width: 25 **Depth:** 27.75 **Height:** 38.25
AH: 20 **SH:** 19.25 **SD:** 18.75 **IW:** 18
Weight: 38 / 51 lbs **Cube:** 21.65

D	E	F	G	H	J	K _{COM}	L	M	N	O	P	Q	R	S	T	U	(# above U) *	S Nail	M Nail
1800	1809	1818	1827	1836	1845	1854	1863	1872	1881	1890	1899	1908	1917	1926	1935	1944	9 (Riser) + 1944 (U)	60	75

8379-35

Standard Pillows: N/A **Finish Req:** Y
Standard Cushions: High Resiliency 40 **Standard Finish:** N/A
COM: 3.5 yards
 Standard with a gas lift.

Ashton Office Swivel Chair

Width: 25.5 **Depth:** 29.5 **Height:** 33
AH: - **SH:** - **SD:** 19 **IW:** 18
Weight: 55 / 65 lbs **Cube:** 21.65

D	E	F	G	H	J	K _{COM}	L	M	N	O	P	Q	R	S	T	U	(# above U) *	S Nail	M Nail
1875	1887	1899	1911	1923	1935	1947	1959	1971	1983	1995	2007	2019	2031	2043	2055	2067	12 (Riser) + 2067 (U)	60	75

8389-01

Standard Pillows: N/A **Finish Req:** Y
Standard Cushions: High Resiliency 40 **Standard Finish:** N/A
COM: 3.5 yards

Clancy Occasional Chair

Width: 25.5 **Depth:** 29.5 **Height:** 38
AH: 23 **SH:** 19.5 **SD:** 19 **IW:** 18
Weight: 35 / 45 lbs **Cube:** 21.65

D	E	F	G	H	J	K _{COM}	L	M	N	O	P	Q	R	S	T	U	(# above U) *	S Nail	M Nail
1650	1662	1674	1686	1698	1710	1722	1734	1746	1758	1770	1782	1794	1806	1818	1830	1842	12 (Riser) + 1842 (U)	60	75

UPHOLSTERY

8389-35

Clancy Office Swivel Chair

Standard Pillows: N/A **Finish Req:** Y
Standard Cushions: High Resiliency 40 **Standard Finish:** N/A
COM: 3.5 yards
 Standard with a gas lift.

Width: 25.5 **Depth:** 29.5 **Height:** 33
AH: - **SH:** - **SD:** 19 **IW:** 18
Weight: 55 / 65 lbs **Cube:** 21.65

D	E	F	G	H	J	K ^{COM}	L	M	N	O	P	Q	R	S	T	U	(# above U) *	S Nail	M Nail
1980	1992	2004	2016	2028	2040	2052	2064	2076	2088	2100	2112	2124	2136	2148	2160	2172	12 (Riser) + 2172 (U)	60	75

8403-A2

Avilla Arm Chair

Standard Pillows: N/A **Finish Req:** Y
Standard Cushions: High Resiliency 40 **Standard Finish:** N/A
COM: 3.25 yards

Width: 25 **Depth:** 26 **Height:** 39.5
AH: 23.5 **SH:** 20.5 **SD:** 18.5 **IW:** 17
Weight: 30 / 35 lbs **Cube:** 21.65

D	E	F	G	H	J	K ^{COM}	L	M	N	O	P	Q	R	S	T	U	(# above U) *	S Nail	M Nail
1536	1545	1554	1563	1572	1581	1590	1599	1608	1617	1626	1635	1644	1653	1662	1671	1680	9 (Riser) + 1680 (U)	N/A	N/A

8403-04

Avilla Arm Chair

Standard Pillows: N/A **Finish Req:** Y
Standard Cushions: High Resiliency 40 **Standard Finish:** N/A
COM: 3.25 yards

Width: 25 **Depth:** 26 **Height:** 39.5
AH: 23.5 **SH:** 20.5 **SD:** 18.5 **IW:** 17
Weight: 30 / 35 lbs **Cube:** 21.65

D	E	F	G	H	J	K ^{COM}	L	M	N	O	P	Q	R	S	T	U	(# above U) *	S Nail	M Nail
1500	1509	1518	1527	1536	1545	1554	1563	1572	1581	1590	1599	1608	1617	1626	1635	1644	9 (Riser) + 1644 (U)	N/A	N/A

8411-A4

Plymouth Arm Chair

Standard Pillows: N/A **Finish Req:** Y
Standard Cushions: High Resiliency 40 **Standard Finish:** N/A
COM: 2 yards

Width: 23 **Depth:** 23 **Height:** 36.5
AH: 26 **SH:** 19.5 **SD:** 17.5 **IW:** 19
Weight: 30 / 35 lbs **Cube:** 15.74

D	E	F	G	H	J	K ^{COM}	L	M	N	O	P	Q	R	S	T	U	(# above U) *	S Nail	M Nail
1302	1308	1314	1320	1326	1332	1338	1344	1350	1356	1362	1368	1374	1380	1386	1392	1398	6 (Riser) + 1398 (U)	45	60

8411-BC

Plymouth Bariatric Chair

Standard Pillows: N/A **Finish Req:** Y
Standard Cushions: High Resiliency 40 **Standard Finish:** N/A
COM: 2.75 yards
 BIFMA tested up to 500 lbs. (static/dynamic)

Width: 35 **Depth:** 22 **Height:** 37
AH: 25.5 **SH:** 19 **SD:** 16.5 **IW:** 30.5
Weight: 40 / 59 lbs **Cube:** 31.99

D	E	F	G	H	J	K ^{COM}	L	M	N	O	P	Q	R	S	T	U	(# above U) *	S Nail	M Nail
1500	1509	1518	1527	1536	1545	1554	1563	1572	1581	1590	1599	1608	1617	1626	1635	1644	9 (Riser) + 1644 (U)	45	60

8411-04

Plymouth Arm Chair

Standard Pillows: N/A **Finish Req:** Y
Standard Cushions: High Resiliency 40 **Standard Finish:** N/A
COM: 2 yards

Width: 23 **Depth:** 23 **Height:** 36.5
AH: 26 **SH:** 19.5 **SD:** 17.5 **IW:** 19
Weight: 30 / 35 lbs **Cube:** 15.74

D	E	F	G	H	J	K ^{COM}	L	M	N	O	P	Q	R	S	T	U	(# above U) *	S Nail	M Nail
1230	1236	1242	1248	1254	1260	1266	1272	1278	1284	1290	1296	1302	1308	1314	1320	1326	6 (Riser) + 1326 (U)	45	N/A

8444-A4

Selby Arm Chair

Standard Pillows: N/A **Finish Req:** Y
Standard Cushions: High Resiliency 40 **Standard Finish:** N/A
COM: 2 yards

Width: 24.5 **Depth:** 26.5 **Height:** 38.5
AH: 25 **SH:** 18.5 **SD:** 18.5 **IW:** 19.5
Weight: 31 / 41 lbs **Cube:** 15.74

D	E	F	G	H	J	K ^{COM}	L	M	N	O	P	Q	R	S	T	U	(# above U) *	S Nail	M Nail
1314	1320	1326	1332	1338	1344	1350	1356	1362	1368	1374	1380	1386	1392	1398	1404	1410	6 (Riser) + 1410 (U)	N/A	N/A

UPHOLSTERY

8444-04

Standard Pillows: N/A **Finish Req:** Y
Standard Cushions: High Resiliency 40 **Standard Finish:** N/A
COM: 2 yards

Selby Arm Chair

Width: 24.5 **Depth:** 26.5 **Height:** 38.5
AH: 25 **SH:** 18.5 **SD:** 18.5 **IW:** 19.5
Weight: 30 / 35 lbs **Cube:** 21.09

D	E	F	G	H	J	K _{COM}	L	M	N	O	P	Q	R	S	T	U	(# above U) *	S Nail	M Nail
1242	1248	1254	1260	1266	1272	1278	1284	1290	1296	1302	1308	1314	1320	1326	1332	1338	6 (Riser) + 1338 (U)	N/A	N/A

8484-A4

Standard Pillows: N/A **Finish Req:** Y
Standard Cushions: High Resiliency 40 **Standard Finish:** N/A
COM: 2 yards

Powell Arm Chair

Width: 23 **Depth:** 25 **Height:** 38
AH: 26 **SH:** 20 **SD:** 19.5 **IW:** 19.5
Weight: 35 / 40 lbs **Cube:** 15.74

D	E	F	G	H	J	K _{COM}	L	M	N	O	P	Q	R	S	T	U	(# above U) *	S Nail	M Nail
1392	1398	1404	1410	1416	1422	1428	1434	1440	1446	1452	1458	1464	1470	1476	1482	1488	6 (Riser) + 1488 (U)	45	60

8484-04

Standard Pillows: N/A **Finish Req:** Y
Standard Cushions: High Resiliency 40 **Standard Finish:** N/A
COM: 2 yards

Powell Arm Chair

Width: 23 **Depth:** 25 **Height:** 38
AH: 26 **SH:** 20 **SD:** 19.5 **IW:** 19.5
Weight: 35 / 40 lbs **Cube:** 15.74

D	E	F	G	H	J	K _{COM}	L	M	N	O	P	Q	R	S	T	U	(# above U) *	S Nail	M Nail
1320	1326	1332	1338	1344	1350	1356	1362	1368	1374	1380	1386	1392	1398	1404	1410	1416	6 (Riser) + 1416 (U)	45	60

8484-05

Standard Pillows: N/A **Finish Req:** Y
Standard Cushions: High Resiliency 40 **Standard Finish:** N/A
COM: 2 yards

Powell Side Chair

Width: 23 **Depth:** 24 **Height:** 37.5
AH: - **SH:** 19.5 **SD:** 19.5 **IW:** 23.5
Weight: 30 / 35 lbs **Cube:** 15.74

D	E	F	G	H	J	K _{COM}	L	M	N	O	P	Q	R	S	T	U	(# above U) *	S Nail	M Nail
1287	1293	1299	1305	1311	1317	1323	1329	1335	1341	1347	1353	1359	1365	1371	1377	1383	6 (Riser) + 1383 (U)	45	N/A

8486-A4

Standard Pillows: N/A **Finish Req:** Y
Standard Cushions: High Resiliency 40 **Standard Finish:** N/A
COM: 2 yards

Seward Arm Chair

Width: 23 **Depth:** 24.5 **Height:** 38
AH: 26.5 **SH:** 20.5 **SD:** 19 **IW:** 20
Weight: 30 / 35 lbs **Cube:** 15.74

D	E	F	G	H	J	K _{COM}	L	M	N	O	P	Q	R	S	T	U	(# above U) *	S Nail	M Nail
1392	1398	1404	1410	1416	1422	1428	1434	1440	1446	1452	1458	1464	1470	1476	1482	1488	6 (Riser) + 1488 (U)	45	60

8486-04

Standard Pillows: N/A **Finish Req:** Y
Standard Cushions: High Resiliency 40 **Standard Finish:** N/A
COM: 2 yards

Seward Arm Chair

Width: 23 **Depth:** 24.5 **Height:** 38
AH: 26.5 **SH:** 20.5 **SD:** 19 **IW:** 20
Weight: 30 / 35 lbs **Cube:** 15.74

D	E	F	G	H	J	K _{COM}	L	M	N	O	P	Q	R	S	T	U	(# above U) *	S Nail	M Nail
1320	1326	1332	1338	1344	1350	1356	1362	1368	1374	1380	1386	1392	1398	1404	1410	1416	6 (Riser) + 1416 (U)	45	60

8499-04

Standard Pillows: N/A **Finish Req:** Y
Standard Cushions: High Resiliency 40 **Standard Finish:** N/A
COM: 1.75 yards

Martine Arm Chair

Width: 23.5 **Depth:** 23 **Height:** 41.5
AH: 27 **SH:** 20 **SD:** 17.5 **IW:** 20
Weight: 30 / 35 lbs **Cube:** 15.74

D	E	F	G	H	J	K _{COM}	L	M	N	O	P	Q	R	S	T	U	(# above U) *	S Nail	M Nail
1320	1326	1332	1338	1344	1350	1356	1362	1368	1374	1380	1386	1392	1398	1404	1410	1416	6 (Riser) + 1416 (U)	N/A	N/A

UPHOLSTERY

8700-A4

Preston Arm Chair

Standard Pillows: N/A **Finish Req:** Y
Standard Cushions: High Resiliency 40 **Standard Finish:** N/A
COM: 2.25 yards

Width: 23.5 **Depth:** 23.5 **Height:** 38
AH: 25 **SH:** 19 **SD:** 19.5 **IW:** 20
Weight: 30 / 35 lbs **Cube:** 15.74

D	E	F	G	H	J	K _{COM}	L	M	N	O	P	Q	R	S	T	U	(# above U) *	S Nail	M Nail
1302	1308	1314	1320	1326	1332	1338	1344	1350	1356	1362	1368	1374	1380	1386	1392	1398	6 (Riser) + 1398 (U)	45	60

8700-04

Preston Arm Chair

Standard Pillows: N/A **Finish Req:** Y
Standard Cushions: High Resiliency 40 **Standard Finish:** N/A
COM: 2.25 yards

Width: 23.5 **Depth:** 23.5 **Height:** 38
AH: 25 **SH:** 19 **SD:** 19.5 **IW:** 20
Weight: 30 / 35 lbs **Cube:** 15.74

D	E	F	G	H	J	K _{COM}	L	M	N	O	P	Q	R	S	T	U	(# above U) *	S Nail	M Nail
1230	1236	1242	1248	1254	1260	1266	1272	1278	1284	1290	1296	1302	1308	1314	1320	1326	6 (Riser) + 1326 (U)	45	60

8700-11

Preston Arm Stack Chair

Standard Pillows: N/A **Finish Req:** Y
Standard Cushions: High Resiliency 40 **Standard Finish:** N/A
COM: 2 yards
 Available in FairShield Plus Finishes Only. Warranted for stacking three high.

Width: 24.5 **Depth:** 22.5 **Height:** 35
AH: 26 **SH:** 19 **SD:** 18.5 **IW:** 20.5
Weight: 23 / 28 lbs **Cube:** 15.74

D	E	F	G	H	J	K _{COM}	L	M	N	O	P	Q	R	S	T	U	(# above U) *	S Nail	M Nail
1230	1236	1242	1248	1254	1260	1266	1272	1278	1284	1290	1296	1302	1308	1314	1320	1326	6 (Riser) + 1326 (U)	45	60

8702-04

Spiro Arm Chair

Standard Pillows: N/A **Finish Req:** Y
Standard Cushions: High Resiliency 40 **Standard Finish:** N/A
COM: 2 yards

Width: 23 **Depth:** 24 **Height:** 37.5
AH: 26.5 **SH:** 19 **SD:** 18.5 **IW:** 20.5
Weight: 30 / 35 lbs **Cube:** 15.74

D	E	F	G	H	J	K _{COM}	L	M	N	O	P	Q	R	S	T	U	(# above U) *	S Nail	M Nail
1365	1371	1377	1383	1389	1395	1401	1407	1413	1419	1425	1431	1437	1443	1449	1455	1461	6 (Riser) + 1461 (U)	45	N/A

8706-A2

Godfrey Arm Chair

Standard Pillows: N/A **Finish Req:** Y
Standard Cushions: High Resiliency 40 **Standard Finish:** N/A
COM: 2 yards

Width: 24 **Depth:** 23 **Height:** 38.5
AH: 25 **SH:** 18.5 **SD:** 18 **IW:** 20
Weight: 30 / 35 lbs **Cube:** 15.74

D	E	F	G	H	J	K _{COM}	L	M	N	O	P	Q	R	S	T	U	(# above U) *	S Nail	M Nail
1221	1227	1233	1239	1245	1251	1257	1263	1269	1275	1281	1287	1293	1299	1305	1311	1317	6 (Riser) + 1317 (U)	N/A	N/A

8706-A4

Godfrey Arm Chair

Standard Pillows: N/A **Finish Req:** Y
Standard Cushions: High Resiliency 40 **Standard Finish:** N/A
COM: 2 yards

Width: 24 **Depth:** 23 **Height:** 38.5
AH: 25 **SH:** 18.5 **SD:** 18 **IW:** 20
Weight: 30 / 35 lbs **Cube:** 15.74

D	E	F	G	H	J	K _{COM}	L	M	N	O	P	Q	R	S	T	U	(# above U) *	S Nail	M Nail
1257	1263	1269	1275	1281	1287	1293	1299	1305	1311	1317	1323	1329	1335	1341	1347	1353	6 (Riser) + 1353 (U)	N/A	N/A

8706-04

Godfrey Arm Chair

Standard Pillows: N/A **Finish Req:** Y
Standard Cushions: High Resiliency 40 **Standard Finish:** N/A
COM: 2 yards

Width: 24 **Depth:** 23 **Height:** 38.5
AH: 25 **SH:** 18.5 **SD:** 18 **IW:** 20
Weight: 30 / 35 lbs **Cube:** 15.74

D	E	F	G	H	J	K _{COM}	L	M	N	O	P	Q	R	S	T	U	(# above U) *	S Nail	M Nail
1125	1131	1137	1143	1149	1155	1161	1167	1173	1179	1185	1191	1197	1203	1209	1215	1221	6 (Riser) + 1221 (U)	N/A	N/A

UPHOLSTERY

8713-04

Standard Pillows: N/A **Finish Req:** Y
Standard Cushions: High Resiliency 30 **Standard Finish:** N/A
COM: 4.5 yards

Maya Arm Chair

Width: 26 **Depth:** 28.5 **Height:** 42.5
AH: 27 **SH:** 20.5 **SD:** 18 **IW:** 18
Weight: 41 / 46 lbs **Cube:** 21.65

D	E	F	G	H	J	K _{COM}	L	M	N	O	P	Q	R	S	T	U	(# above U) *	S Nail	M Nail
1716	1728	1740	1752	1764	1776	1788	1800	1812	1824	1836	1848	1860	1872	1884	1896	1908	12 (Riser) + 1908 (U)	45	60

8713-05

Standard Pillows: N/A **Finish Req:** Y
Standard Cushions: High Resiliency 30 **Standard Finish:** N/A
COM: 3.25 yards

Maya Side Chair

Width: 23 **Depth:** 28.5 **Height:** 42.5
AH: - **SH:** 20.5 **SD:** 18.5 **IW:** 23
Weight: 26 / 31 lbs **Cube:** 21.65

D	E	F	G	H	J	K _{COM}	L	M	N	O	P	Q	R	S	T	U	(# above U) *	S Nail	M Nail
1365	1374	1383	1392	1401	1410	1419	1428	1437	1446	1455	1464	1473	1482	1491	1500	1509	9 (Riser) + 1509 (U)	45	60

8718-05

Standard Pillows: N/A **Finish Req:** Y
Standard Cushions: High Resiliency 40 **Standard Finish:** N/A
COM: 2.25 yards

Wallace Side Chair

Width: 22 **Depth:** 24.5 **Height:** 38.5
AH: - **SH:** 19.5 **SD:** 19.5 **IW:** 22
Weight: 30 / 35 lbs **Cube:** 15.74

D	E	F	G	H	J	K _{COM}	L	M	N	O	P	Q	R	S	T	U	(# above U) *	S Nail	M Nail
1290	1296	1302	1308	1314	1320	1326	1332	1338	1344	1350	1356	1362	1368	1374	1380	1386	6 (Riser) + 1386 (U)	45	60

8719-A2

Standard Pillows: N/A **Finish Req:** Y
Standard Cushions: High Resiliency 55 **Standard Finish:** N/A
COM: 2 yards

Kingsport Arm Chair

Width: 22 **Depth:** 26 **Height:** 35
AH: 25 **SH:** 19 **SD:** 18.5 **IW:** 19
Weight: 30 / 35 lbs **Cube:** 15.74

D	E	F	G	H	J	K _{COM}	L	M	N	O	P	Q	R	S	T	U	(# above U) *	S Nail	M Nail
1266	1272	1278	1284	1290	1296	1302	1308	1314	1320	1326	1332	1338	1344	1350	1356	1362	6 (Riser) + 1362 (U)	N/A	N/A

8720-C6

Standard Pillows: N/A **Finish Req:** Y
Standard Cushions: High Resiliency 40 **Standard Finish:** N/A
COM: 2.5 yards

Albany Counter Stool

Width: 23 **Depth:** 23.5 **Height:** 38
AH: 32 **SH:** 26 **SD:** 20.5 **IW:** 18.5
Weight: 35 / 45 lbs **Cube:** 15.74

D	E	F	G	H	J	K _{COM}	L	M	N	O	P	Q	R	S	T	U	(# above U) *	S Nail	M Nail
1650	1659	1668	1677	1686	1695	1704	1713	1722	1731	1740	1749	1758	1767	1776	1785	1794	9 (Riser) + 1794 (U)	45	60

8720-04

Standard Pillows: N/A **Finish Req:** Y
Standard Cushions: High Resiliency 40 **Standard Finish:** N/A
COM: 2.5 yards

Albany Arm Chair

Width: 23 **Depth:** 23.5 **Height:** 31.5
AH: 25.5 **SH:** 19.5 **SD:** 20.5 **IW:** 18.5
Weight: 21 / 31 lbs **Cube:** 15.74

D	E	F	G	H	J	K _{COM}	L	M	N	O	P	Q	R	S	T	U	(# above U) *	S Nail	M Nail
1572	1581	1590	1599	1608	1617	1626	1635	1644	1653	1662	1671	1680	1689	1698	1707	1716	9 (Riser) + 1716 (U)	45	60

8720-06

Standard Pillows: N/A **Finish Req:** Y
Standard Cushions: High Resiliency 40 **Standard Finish:** N/A
COM: 2.5 yards

Albany Bar Stool

Width: 23 **Depth:** 23.5 **Height:** 42
AH: 36 **SH:** 30 **SD:** 20.5 **IW:** 18.5
Weight: 40 / 51 lbs **Cube:** 17.77

D	E	F	G	H	J	K _{COM}	L	M	N	O	P	Q	R	S	T	U	(# above U) *	S Nail	M Nail
1650	1659	1668	1677	1686	1695	1704	1713	1722	1731	1740	1749	1758	1767	1776	1785	1794	9 (Riser) + 1794 (U)	45	60

UPHOLSTERY

8721-BC

Brady Bariatric Chair

Width: 34 Depth: 26 Height: 39
 AH: 25.5 SH: 19 SD: 19.5 IW: 30.5
 Weight: 45 / 64 lbs Cube: 31.99

Standard Pillows: N/A Finish Req: Y
 Standard Cushions: High Resiliency 55 Standard Finish: N/A
 COM: 3.25 yards
 BIFMA tested up to 500 lbs. (static/dynamic)

D	E	F	G	H	J	K _{COM}	L	M	N	O	P	Q	R	S	T	U	(# above U) *	S Nail	M Nail
1530	1539	1548	1557	1566	1575	1584	1593	1602	1611	1620	1629	1638	1647	1656	1665	1674	9 (Riser) + 1674 (U)	45	60

8721-04

Brady Arm Chair

Width: 24 Depth: 25 Height: 39.5
 AH: 25.5 SH: 19 SD: 19 IW: 20
 Weight: 35 / 40 lbs Cube: 15.74

Standard Pillows: N/A Finish Req: Y
 Standard Cushions: High Resiliency 55 Standard Finish: N/A
 COM: 2.25 yards

D	E	F	G	H	J	K _{COM}	L	M	N	O	P	Q	R	S	T	U	(# above U) *	S Nail	M Nail
1242	1248	1254	1260	1266	1272	1278	1284	1290	1296	1302	1308	1314	1320	1326	1332	1338	6 (Riser) + 1338 (U)	45	60

8721-05

Brady Side Chair

Width: 24 Depth: 24.5 Height: 39
 AH: - SH: 19.5 SD: 19.5 IW: 24
 Weight: 30 / 35 lbs Cube: 15.74

Standard Pillows: N/A Finish Req: Y
 Standard Cushions: High Resiliency 55 Standard Finish: N/A
 COM: 2.25 yards

D	E	F	G	H	J	K _{COM}	L	M	N	O	P	Q	R	S	T	U	(# above U) *	S Nail	M Nail
1185	1191	1197	1203	1209	1215	1221	1227	1233	1239	1245	1251	1257	1263	1269	1275	1281	6 (Riser) + 1281 (U)	45	60

8726-01

Nora Occasional Chair

Width: 24.5 Depth: 25.5 Height: 40.5
 AH: 26 SH: 19.5 SD: 19.5 IW: 19.5
 Weight: 35 / 40 lbs Cube: 17.77

Standard Pillows: N/A Finish Req: Y
 Standard Cushions: High Resiliency 40 Standard Finish: N/A
 COM: 3.25 yards

D	E	F	G	H	J	K _{COM}	L	M	N	O	P	Q	R	S	T	U	(# above U) *	S Nail	M Nail
1350	1359	1368	1377	1386	1395	1404	1413	1422	1431	1440	1449	1458	1467	1476	1485	1494	9 (Riser) + 1494 (U)	N/A	N/A

8727-A4

Murphy Arm Chair

Width: 23.5 Depth: 22.5 Height: 34.5
 AH: 26 SH: 18.5 SD: 18.5 IW: 18
 Weight: 22 / 27 lbs Cube: 15.74

Standard Pillows: N/A Finish Req: Y
 Standard Cushions: High Resiliency 40 Standard Finish: N/A
 COM: 2.25 yards

D	E	F	G	H	J	K _{COM}	L	M	N	O	P	Q	R	S	T	U	(# above U) *	S Nail	M Nail
1674	1683	1692	1701	1710	1719	1728	1737	1746	1755	1764	1773	1782	1791	1800	1809	1818	9 (Riser) + 1818 (U)	45	N/A

8727-04

Murphy Arm Chair

Width: 23.5 Depth: 22.5 Height: 34.5
 AH: 26 SH: 18.5 SD: 18.5 IW: 18
 Weight: 20 / 30 lbs Cube: 15.74

Standard Pillows: N/A Finish Req: Y
 Standard Cushions: High Resiliency 40 Standard Finish: N/A
 COM: 2.25 yards

D	E	F	G	H	J	K _{COM}	L	M	N	O	P	Q	R	S	T	U	(# above U) *	S Nail	M Nail
1602	1611	1620	1629	1638	1647	1656	1665	1674	1683	1692	1701	1710	1719	1728	1737	1746	9 (Riser) + 1746 (U)	45	N/A

8729-05

Douglas Side Chair

Width: 20.5 Depth: 21 Height: 31
 AH: - SH: 18.5 SD: 19 IW: 20.5
 Weight: 25 / 30 lbs Cube: 15.74

Standard Pillows: N/A Finish Req: Y
 Standard Cushions: High Resiliency 40 Standard Finish: N/A
 COM: 2 yards

D	E	F	G	H	J	K _{COM}	L	M	N	O	P	Q	R	S	T	U	(# above U) *	S Nail	M Nail
1170	1176	1182	1188	1194	1200	1206	1212	1218	1224	1230	1236	1242	1248	1254	1260	1266	6 (Riser) + 1266 (U)	45	N/A

UPHOLSTERY

8730-04

Standard Pillows: N/A **Finish Req:** Y
Standard Cushions: High Resiliency 40 **Standard Finish:** N/A
COM: 2 yards

Edgemont Arm Chair

Width: 23.5 **Depth:** 25.5 **Height:** 36.5
AH: 25.5 **SH:** 18.5 **SD:** 18.5 **IW:** 20
Weight: 30 / 35 lbs **Cube:** 15.74

D	E	F	G	H	J	K _{COM}	L	M	N	O	P	Q	R	S	T	U	(# above U) *	S Nail	M Nail
1290	1296	1302	1308	1314	1320	1326	1332	1338	1344	1350	1356	1362	1368	1374	1380	1386	6 (Riser) + 1386 (U)	N/A	N/A

8731-01

Standard Pillows: N/A **Finish Req:** Y
Standard Cushions: High Resiliency 30 **Standard Finish:** N/A
COM: 4.75 yards

Myla Occasional Chair

Width: 28 **Depth:** 31 **Height:** 36.5
AH: 25 **SH:** 19 **SD:** 19.5 **IW:** 18.5
Weight: 50 / 60 lbs **Cube:** 23.22

D	E	F	G	H	J	K _{COM}	L	M	N	O	P	Q	R	S	T	U	(# above U) *	S Nail	M Nail
1725	1740	1755	1770	1785	1800	1815	1830	1845	1860	1875	1890	1905	1920	1935	1950	1965	15 (Riser) + 1965 (U)	45	60

8732-A2

Standard Pillows: N/A **Finish Req:** Y
Standard Cushions: High Resiliency 40 **Standard Finish:** N/A
COM: 2 yards

Fayette Occasional Chair

Width: 26 **Depth:** 24.5 **Height:** 33
AH: 26 **SH:** 20 **SD:** 20.5 **IW:** 21
Weight: 35 / 40 lbs **Cube:** 15.74

D	E	F	G	H	J	K _{COM}	L	M	N	O	P	Q	R	S	T	U	(# above U) *	S Nail	M Nail
1440	1446	1452	1458	1464	1470	1476	1482	1488	1494	1500	1506	1512	1518	1524	1530	1536	6 (Riser) + 1536 (U)	Std.	N/A

8732-A4

Standard Pillows: N/A **Finish Req:** Y
Standard Cushions: High Resiliency 40 **Standard Finish:** N/A
COM: 2 yards

Fayette Occasional Chair

Width: 26 **Depth:** 24.5 **Height:** 33
AH: 26 **SH:** 19.5 **SD:** 19.5 **IW:** 21
Weight: 35 / 40 lbs **Cube:** 15.74

D	E	F	G	H	J	K _{COM}	L	M	N	O	P	Q	R	S	T	U	(# above U) *	S Nail	M Nail
1476	1482	1488	1494	1500	1506	1512	1518	1524	1530	1536	1542	1548	1554	1560	1566	1572	6 (Riser) + 1572 (U)	Std.	N/A

8732-01

Standard Pillows: N/A **Finish Req:** Y
Standard Cushions: High Resiliency 40 **Standard Finish:** N/A
COM: 2 yards

Fayette Occasional Chair

Width: 26 **Depth:** 24.5 **Height:** 33
AH: 26 **SH:** 20 **SD:** 20.5 **IW:** 21
Weight: 35 / 40 lbs **Cube:** 15.74

D	E	F	G	H	J	K _{COM}	L	M	N	O	P	Q	R	S	T	U	(# above U) *	S Nail	M Nail
1404	1410	1416	1422	1428	1434	1440	1446	1452	1458	1464	1470	1476	1482	1488	1494	1500	6 (Riser) + 1500 (U)	Std.	N/A

8735-A4

Standard Pillows: N/A **Finish Req:** Y
Standard Cushions: High Resiliency 40 **Standard Finish:** N/A
COM: 4.25 yards

Vanessa Arm Chair

Width: 26 **Depth:** 27.5 **Height:** 40
AH: 25.5 **SH:** 18.5 **SD:** 21 **IW:** 20
Weight: 33 / 46 lbs **Cube:** 21.65

D	E	F	G	H	J	K _{COM}	L	M	N	O	P	Q	R	S	T	U	(# above U) *	S Nail	M Nail
1722	1734	1746	1758	1770	1782	1794	1806	1818	1830	1842	1854	1866	1878	1890	1902	1914	12 (Riser) + 1914 (U)	N/A	N/A

8735-04

Standard Pillows: N/A **Finish Req:** Y
Standard Cushions: High Resiliency 40 **Standard Finish:** N/A
COM: 4.25 yards

Vanessa Arm Chair

Width: 26 **Depth:** 27.5 **Height:** 40
AH: 25.5 **SH:** 18.5 **SD:** 21 **IW:** 20
Weight: 33 / 46 lbs **Cube:** 21.65

D	E	F	G	H	J	K _{COM}	L	M	N	O	P	Q	R	S	T	U	(# above U) *	S Nail	M Nail
1650	1662	1674	1686	1698	1710	1722	1734	1746	1758	1770	1782	1794	1806	1818	1830	1842	12 (Riser) + 1842 (U)	N/A	N/A

UPHOLSTERY

8735-05

Standard Pillows: N/A **Finish Req:** Y
Standard Cushions: High Resiliency 40 **Standard Finish:** N/A
COM: 3.5 yards

Vanessa Side Chair

Width: 25.5 **Depth:** 28 **Height:** 37.75
AH: 18 **SH:** 18 **SD:** 19.75 **IW:** 20.5
Weight: 32 / 44 lbs **Cube:** 21.65

D	E	F	G	H	J	K _{COM}	L	M	N	O	P	Q	R	S	T	U	(# above U) *	S Nail	M Nail
1620	1632	1644	1656	1668	1680	1692	1704	1716	1728	1740	1752	1764	1776	1788	1800	1812	12 (Riser) + 1812 (U)	N/A	N/A

8740-A4

Standard Pillows: N/A **Finish Req:** Y
Standard Cushions: High Resiliency 40 **Standard Finish:** N/A
COM: 2.75 yards
Standard 2" Channel Quilt on Outside Back

Anthony Arm Chair

Width: 24 **Depth:** 26 **Height:** 33
AH: 24.5 **SH:** 19.5 **SD:** 20 **IW:** 18
Weight: 26 / 36 lbs **Cube:** 15.74

D	E	F	G	H	J	K _{COM}	L	M	N	O	P	Q	R	S	T	U	(# above U) *	S Nail	M Nail
1812	1821	1830	1839	1848	1857	1866	1875	1884	1893	1902	1911	1920	1929	1938	1947	1956	9 (Riser) + 1956 (U)	60	75

8740-C7

Standard Pillows: N/A **Finish Req:** Y
Standard Cushions: High Resiliency 40 **Standard Finish:** N/A
COM: 2.5 yards
Standard 2" Channel Quilt on Outside Back

Anthony Counter Stool

Width: 21.5 **Depth:** 22 **Height:** 39.5
AH: 30 **SH:** 26 **SD:** 17.5 **IW:** 17.5
Weight: 35 / 45 lbs **Cube:** 15.74

D	E	F	G	H	J	K _{COM}	L	M	N	O	P	Q	R	S	T	U	(# above U) *	S Nail	M Nail
1800	1809	1818	1827	1836	1845	1854	1863	1872	1881	1890	1899	1908	1917	1926	1935	1944	9 (Riser) + 1944 (U)	60	75

8740-04

Standard Pillows: N/A **Finish Req:** Y
Standard Cushions: High Resiliency 40 **Standard Finish:** N/A
COM: 2.75 yards
Standard 2" Channel Quilt on Outside Back

Anthony Arm Chair

Width: 24 **Depth:** 26 **Height:** 33
AH: 24.5 **SH:** 19.5 **SD:** 20 **IW:** 18
Weight: 24 / 34 lbs **Cube:** 15.74

D	E	F	G	H	J	K _{COM}	L	M	N	O	P	Q	R	S	T	U	(# above U) *	S Nail	M Nail
1740	1749	1758	1767	1776	1785	1794	1803	1812	1821	1830	1839	1848	1857	1866	1875	1884	9 (Riser) + 1884 (U)	60	75

8740-05

Standard Pillows: N/A **Finish Req:** Y
Standard Cushions: High Resiliency 40 **Standard Finish:** N/A
COM: 2.5 yards
Standard 2" Channel Quilt on Outside Back

Anthony Side Chair

Width: 22.5 **Depth:** 25 **Height:** 33.5
AH: 20 **SH:** 19.5 **SD:** 19.5 **IW:** 18
Weight: 23 / 33 lbs **Cube:** 15.74

D	E	F	G	H	J	K _{COM}	L	M	N	O	P	Q	R	S	T	U	(# above U) *	S Nail	M Nail
1710	1719	1728	1737	1746	1755	1764	1773	1782	1791	1800	1809	1818	1827	1836	1845	1854	9 (Riser) + 1854 (U)	60	75

8740-07

Standard Pillows: N/A **Finish Req:** Y
Standard Cushions: High Resiliency 40 **Standard Finish:** N/A
COM: 2.5 yards
Standard 2" Channel Quilt on Outside Back

Anthony Bar Stool

Width: 21.5 **Depth:** 22 **Height:** 43.5
AH: 30 **SH:** 30 **SD:** 17.5 **IW:** 17.5
Weight: 40 / 51 lbs **Cube:** 17.77

D	E	F	G	H	J	K _{COM}	L	M	N	O	P	Q	R	S	T	U	(# above U) *	S Nail	M Nail
1800	1809	1818	1827	1836	1845	1854	1863	1872	1881	1890	1899	1908	1917	1926	1935	1944	9 (Riser) + 1944 (U)	60	75

8741-A4

Standard Pillows: N/A **Finish Req:** Y
Standard Cushions: High Resiliency 40 **Standard Finish:** N/A
COM: 2.75 yards

Anthony Arm Chair

Width: 24 **Depth:** 26 **Height:** 33
AH: 24.5 **SH:** 19.5 **SD:** 20 **IW:** 18
Weight: 26 / 39 lbs **Cube:** 21.65

D	E	F	G	H	J	K _{COM}	L	M	N	O	P	Q	R	S	T	U	(# above U) *	S Nail	M Nail
1752	1761	1770	1779	1788	1797	1806	1815	1824	1833	1842	1851	1860	1869	1878	1887	1896	9 (Riser) + 1896 (U)	60	75

UPHOLSTERY

8741-C7

Anthony Counter Stool

Standard Pillows: N/A Finish Req: Y
 Standard Cushions: High Resiliency 40 Standard Finish: N/A
 COM: 2.5 yards

Width: 21.5 Depth: 22 Height: 39.5
 AH: 30 SH: 26.5 SD: 17.5 IW: 17.5
 Weight: 35 / 34 lbs Cube: 15.74

D	E	F	G	H	J	K _{COM}	L	M	N	O	P	Q	R	S	T	U	(# above U) *	S Nail	M Nail
1785	1794	1803	1812	1821	1830	1839	1848	1857	1866	1875	1884	1893	1902	1911	1920	1929	9 (Riser) + 1929 (U)	60	75

8741-04

Anthony Arm Chair

Standard Pillows: N/A Finish Req: Y
 Standard Cushions: High Resiliency 40 Standard Finish: N/A
 COM: 2.75 yards

Width: 24 Depth: 26 Height: 33
 AH: 24.5 SH: 19.5 SD: 20 IW: 18
 Weight: 24 / 29 lbs Cube: 15.74

D	E	F	G	H	J	K _{COM}	L	M	N	O	P	Q	R	S	T	U	(# above U) *	S Nail	M Nail
1680	1689	1698	1707	1716	1725	1734	1743	1752	1761	1770	1779	1788	1797	1806	1815	1824	9 (Riser) + 1824 (U)	60	75

8741-05

Anthony Side Chair

Standard Pillows: N/A Finish Req: Y
 Standard Cushions: High Resiliency 40 Standard Finish: N/A
 COM: 2.5 yards

Width: 22.5 Depth: 25 Height: 33.5
 AH: 20 SH: 19.5 SD: 19.5 IW: 18
 Weight: 23 / 33 lbs Cube: 15.74

D	E	F	G	H	J	K _{COM}	L	M	N	O	P	Q	R	S	T	U	(# above U) *	S Nail	M Nail
1650	1659	1668	1677	1686	1695	1704	1713	1722	1731	1740	1749	1758	1767	1776	1785	1794	9 (Riser) + 1794 (U)	60	75

8741-07

Anthony Bar Stool

Standard Pillows: N/A Finish Req: Y
 Standard Cushions: High Resiliency 40 Standard Finish: N/A
 COM: 2.5 yards

Width: 21.5 Depth: 22 Height: 43.5
 AH: 30 SH: 30 SD: 17.5 IW: 17.5
 Weight: 25 / 36 lbs Cube: 19.6

D	E	F	G	H	J	K _{COM}	L	M	N	O	P	Q	R	S	T	U	(# above U) *	S Nail	M Nail
1785	1794	1803	1812	1821	1830	1839	1848	1857	1866	1875	1884	1893	1902	1911	1920	1929	9 (Riser) + 1929 (U)	60	75

8742-C6

Proctor Counter Stool

Standard Pillows: N/A Finish Req: Y
 Standard Cushions: High Resiliency 40 Standard Finish: N/A
 COM: 2 yards

Width: 22 Depth: 22.5 Height: 40
 AH: 31.5 SH: 26 SD: 18 IW: 19
 Weight: 23 / 33 lbs Cube: 15.74

D	E	F	G	H	J	K _{COM}	L	M	N	O	P	Q	R	S	T	U	(# above U) *	S Nail	M Nail
1455	1461	1467	1473	1479	1485	1491	1497	1503	1509	1515	1521	1527	1533	1539	1545	1551	6 (Riser) + 1551 (U)	45	N/A

8742-04

Proctor Arm Chair

Standard Pillows: N/A Finish Req: Y
 Standard Cushions: High Resiliency 40 Standard Finish: N/A
 COM: 2 yards

Width: 24 Depth: 23 Height: 35
 AH: 26.5 SH: 19 SD: 18.5 IW: 20
 Weight: 30 / 35 lbs Cube: 15.74

D	E	F	G	H	J	K _{COM}	L	M	N	O	P	Q	R	S	T	U	(# above U) *	S Nail	M Nail
1260	1266	1272	1278	1284	1290	1296	1302	1308	1314	1320	1326	1332	1338	1344	1350	1356	6 (Riser) + 1356 (U)	45	N/A

8742-06

Proctor Bar Stool

Standard Pillows: N/A Finish Req: Y
 Standard Cushions: High Resiliency 40 Standard Finish: N/A
 COM: 2 yards

Width: 22 Depth: 22.5 Height: 44
 AH: 35.5 SH: 30 SD: 18 IW: 19
 Weight: 25 / 35 lbs Cube: 17.77

D	E	F	G	H	J	K _{COM}	L	M	N	O	P	Q	R	S	T	U	(# above U) *	S Nail	M Nail
1455	1461	1467	1473	1479	1485	1491	1497	1503	1509	1515	1521	1527	1533	1539	1545	1551	6 (Riser) + 1551 (U)	45	N/A

UPHOLSTERY

8744-A2

Standard Pillows: N/A **Finish Req:** Y
Standard Cushions: High Resiliency 40 **Standard Finish:** N/A
COM: 2.25 yards

Langston Arm Chair

Width: 24.5 **Depth:** 25 **Height:** 38.5
AH: 25 **SH:** 19 **SD:** 19 **IW:** 20.5
Weight: 30 / 40 lbs **Cube:** 21.09

D	E	F	G	H	J	K _{COM}	L	M	N	O	P	Q	R	S	T	U	(# above U) *	S Nail	M Nail
1278	1287	1296	1305	1314	1323	1332	1341	1350	1359	1368	1377	1386	1395	1404	1413	1422	9 (Riser) + 1422 (U)	45	N/A

8744-A4

Standard Pillows: N/A **Finish Req:** Y
Standard Cushions: High Resiliency 40 **Standard Finish:** N/A
COM: 2.25 yards

Langston Arm Chair

Width: 24.5 **Depth:** 25 **Height:** 38.5
AH: 25 **SH:** 19 **SD:** 19 **IW:** 20.5
Weight: 30 / 40 lbs **Cube:** 21.09

D	E	F	G	H	J	K _{COM}	L	M	N	O	P	Q	R	S	T	U	(# above U) *	S Nail	M Nail
1314	1323	1332	1341	1350	1359	1368	1377	1386	1395	1404	1413	1422	1431	1440	1449	1458	9 (Riser) + 1458 (U)	45	N/A

8744-04

Standard Pillows: N/A **Finish Req:** Y
Standard Cushions: High Resiliency 40 **Standard Finish:** N/A
COM: 2.25 yards

Langston Arm Chair

Width: 24.5 **Depth:** 25 **Height:** 38.5
AH: 25 **SH:** 19 **SD:** 19 **IW:** 20.5
Weight: 30 / 40 lbs **Cube:** 15.74

D	E	F	G	H	J	K _{COM}	L	M	N	O	P	Q	R	S	T	U	(# above U) *	S Nail	M Nail
1242	1251	1260	1269	1278	1287	1296	1305	1314	1323	1332	1341	1350	1359	1368	1377	1386	9 (Riser) + 1386 (U)	45	N/A

8745-C6

Standard Pillows: N/A **Finish Req:** Y
Standard Cushions: High Resiliency 40 **Standard Finish:** N/A
COM: 2 yards

Potter Counter Stool

Width: 22 **Depth:** 22.5 **Height:** 40
AH: 31.5 **SH:** 26 **SD:** 18 **IW:** 19
Weight: 25 / 36 lbs **Cube:** 17.77

D	E	F	G	H	J	K _{COM}	L	M	N	O	P	Q	R	S	T	U	(# above U) *	S Nail	M Nail
1395	1401	1407	1413	1419	1425	1431	1437	1443	1449	1455	1461	1467	1473	1479	1485	1491	6 (Riser) + 1491 (U)	45	N/A

8745-04

Standard Pillows: N/A **Finish Req:** Y
Standard Cushions: High Resiliency 40 **Standard Finish:** N/A
COM: 2 yards

Potter Arm Chair

Width: 24 **Depth:** 23 **Height:** 35
AH: 26.5 **SH:** 19 **SD:** 18.5 **IW:** 20
Weight: 30 / 40 lbs **Cube:** 15.74

D	E	F	G	H	J	K _{COM}	L	M	N	O	P	Q	R	S	T	U	(# above U) *	S Nail	M Nail
1242	1248	1254	1260	1266	1272	1278	1284	1290	1296	1302	1308	1314	1320	1326	1332	1338	6 (Riser) + 1338 (U)	45	N/A

8745-06

Standard Pillows: N/A **Finish Req:** Y
Standard Cushions: High Resiliency 40 **Standard Finish:** N/A
COM: 2 yards

Potter Bar Stool

Width: 22 **Depth:** 22.5 **Height:** 44
AH: 35.5 **SH:** 30 **SD:** 18 **IW:** 19
Weight: 25 / 38 lbs **Cube:** 19.6

D	E	F	G	H	J	K _{COM}	L	M	N	O	P	Q	R	S	T	U	(# above U) *	S Nail	M Nail
1395	1401	1407	1413	1419	1425	1431	1437	1443	1449	1455	1461	1467	1473	1479	1485	1491	6 (Riser) + 1491 (U)	45	N/A

8747-A4

Standard Pillows: N/A **Finish Req:** Y
Standard Cushions: High Resiliency 40 **Standard Finish:** N/A
COM: 2 yards

Garland Arm Chair

Width: 23.5 **Depth:** 24.5 **Height:** 39
AH: 25.5 **SH:** 19 **SD:** 18 **IW:** 19
Weight: 35 / 40 lbs **Cube:** 15.74

D	E	F	G	H	J	K _{COM}	L	M	N	O	P	Q	R	S	T	U	(# above U) *	S Nail	M Nail
1362	1368	1374	1380	1386	1392	1398	1404	1410	1416	1422	1428	1434	1440	1446	1452	1458	6 (Riser) + 1458 (U)	45	N/A

UPHOLSTERY

8747-04

Standard Pillows: N/A **Finish Req:** Y
Standard Cushions: High Resiliency 40 **Standard Finish:** N/A
COM: 2 yards

Garland Arm Chair

Width: 23.5 **Depth:** 24.5 **Height:** 39
AH: 25.5 **SH:** 19 **SD:** 18 **IW:** 19
Weight: 35 / 40 lbs **Cube:** 15.74

D	E	F	G	H	J	K _{COM}	L	M	N	O	P	Q	R	S	T	U	(# above U) *	S Nail	M Nail
1290	1296	1302	1308	1314	1320	1326	1332	1338	1344	1350	1356	1362	1368	1374	1380	1386	6 (Riser) + 1386 (U)	45	N/A

8747-40

Standard Pillows: N/A **Finish Req:** Y
Standard Cushions: High Resiliency 40 **Standard Finish:** N/A
COM: 4 yards

Garland Settee

Width: 49.5 **Depth:** 24 **Height:** 34
AH: 25.5 **SH:** 18.5 **SD:** 18 **IW:** 44.5
Weight: 50 / 60 lbs **Cube:** 29.96

D	E	F	G	H	J	K _{COM}	L	M	N	O	P	Q	R	S	T	U	(# above U) *	S Nail	M Nail
1950	1962	1974	1986	1998	2010	2022	2034	2046	2058	2070	2082	2094	2106	2118	2130	2142	12 (Riser) + 2142 (U)	60	45

8749-A4

Standard Pillows: N/A **Finish Req:** Y
Standard Cushions: High Resiliency 40 **Standard Finish:** N/A
COM: 2.25 yards

Palmer Arm Chair

Width: 24 **Depth:** 24 **Height:** 38.5
AH: 25 **SH:** 20 **SD:** 18 **IW:** 19.5
Weight: 25 / 38 lbs **Cube:** 21.65

D	E	F	G	H	J	K _{COM}	L	M	N	O	P	Q	R	S	T	U	(# above U) *	S Nail	M Nail
1722	1731	1740	1749	1758	1767	1776	1785	1794	1803	1812	1821	1830	1839	1848	1857	1866	9 (Riser) + 1866 (U)	45	N/A

8749-04

Standard Pillows: N/A **Finish Req:** Y
Standard Cushions: High Resiliency 40 **Standard Finish:** N/A
COM: 2.25 yards

Palmer Arm Chair

Width: 24 **Depth:** 24 **Height:** 38.5
AH: 25 **SH:** 20 **SD:** 18 **IW:** 19.5
Weight: 23 / 36 lbs **Cube:** 21.65

D	E	F	G	H	J	K _{COM}	L	M	N	O	P	Q	R	S	T	U	(# above U) *	S Nail	M Nail
1650	1659	1668	1677	1686	1695	1704	1713	1722	1731	1740	1749	1758	1767	1776	1785	1794	9 (Riser) + 1794 (U)	45	N/A

8750-A4

Standard Pillows: N/A **Finish Req:** Y
Standard Cushions: High Resiliency 40 **Standard Finish:** N/A
COM: 2.25 yards

Jade Arm Chair

Width: 23 **Depth:** 25 **Height:** 35
AH: 25 **SH:** 18.5 **SD:** 18.5 **IW:** 19
Weight: 22 / 32 lbs **Cube:** 15.74

D	E	F	G	H	J	K _{COM}	L	M	N	O	P	Q	R	S	T	U	(# above U) *	S Nail	M Nail
1458	1464	1470	1476	1482	1488	1494	1500	1506	1512	1518	1524	1530	1536	1542	1548	1554	6 (Riser) + 1554 (U)	N/A	N/A

8750-04

Standard Pillows: N/A **Finish Req:** Y
Standard Cushions: High Resiliency 40 **Standard Finish:** N/A
COM: 2.25 yards

Jade Arm Chair

Width: 23 **Depth:** 25 **Height:** 35
AH: 25 **SH:** 18.5 **SD:** 18.5 **IW:** 19
Weight: 22 / 32 lbs **Cube:** 15.74

D	E	F	G	H	J	K _{COM}	L	M	N	O	P	Q	R	S	T	U	(# above U) *	S Nail	M Nail
1386	1392	1398	1404	1410	1416	1422	1428	1434	1440	1446	1452	1458	1464	1470	1476	1482	6 (Riser) + 1482 (U)	N/A	N/A

8750-05

Standard Pillows: N/A **Finish Req:** Y
Standard Cushions: High Resiliency 40 **Standard Finish:** N/A
COM: 2.25 yards

Jade Side Chair

Width: 21.5 **Depth:** 27 **Height:** 37.5
AH: - **SH:** 19 **SD:** 17.5 **IW:** 21.5
Weight: 19 / 29 lbs **Cube:** 15.74

D	E	F	G	H	J	K _{COM}	L	M	N	O	P	Q	R	S	T	U	(# above U) *	S Nail	M Nail
1356	1362	1368	1374	1380	1386	1392	1398	1404	1410	1416	1422	1428	1434	1440	1446	1452	6 (Riser) + 1452 (U)	N/A	N/A

UPHOLSTERY

8751-04

Standard Pillows: N/A **Finish Req:** Y
Standard Cushions: High Resiliency 40 **Standard Finish:** N/A
COM: 2.25 yards

Jude Arm Chair

Width: 23 **Depth:** 25 **Height:** 35
AH: 25 **SH:** 18.5 **SD:** 18.5 **IW:** 19
Weight: 22 / 32 lbs **Cube:** 15.74

D	E	F	G	H	J	K _{COM}	L	M	N	O	P	Q	R	S	T	U	(# above U) *	S Nail	M Nail
1422	1428	1434	1440	1446	1452	1458	1464	1470	1476	1482	1488	1494	1500	1506	1512	1518	6 (Riser) + 1518 (U)	N/A	N/A

8751-05

Standard Pillows: N/A **Finish Req:** Y
Standard Cushions: High Resiliency 40 **Standard Finish:** N/A
COM: 2.25 yards

Jude Side Chair

Width: 21.5 **Depth:** 27 **Height:** 37.5
AH: - **SH:** 19 **SD:** 17.5 **IW:** 21.5
Weight: 19 / 29 lbs **Cube:** 15.74

D	E	F	G	H	J	K _{COM}	L	M	N	O	P	Q	R	S	T	U	(# above U) *	S Nail	M Nail
1392	1398	1404	1410	1416	1422	1428	1434	1440	1446	1452	1458	1464	1470	1476	1482	1488	6 (Riser) + 1488 (U)	N/A	N/A

8755-A2

Standard Pillows: N/A **Finish Req:** Y
Standard Cushions: High Resiliency 55 **Standard Finish:** N/A
COM: 2 yards

Opel Arm Chair

Width: 25.5 **Depth:** 22.5 **Height:** 39.5
AH: 26 **SH:** 19.5 **SD:** 20 **IW:** 23
Weight: 35 / 40 lbs **Cube:** 15.74

D	E	F	G	H	J	K _{COM}	L	M	N	O	P	Q	R	S	T	U	(# above U) *	S Nail	M Nail
1308	1314	1320	1326	1332	1338	1344	1350	1356	1362	1368	1374	1380	1386	1392	1398	1404	6 (Riser) + 1404 (U)	N/A	N/A

8755-A4

Standard Pillows: N/A **Finish Req:** Y
Standard Cushions: High Resiliency 55 **Standard Finish:** N/A
COM: 2 yards

Opel Arm Chair

Width: 25.5 **Depth:** 22.5 **Height:** 39.5
AH: 26 **SH:** 19.5 **SD:** 20 **IW:** 23
Weight: 40 / 45 lbs **Cube:** 17.77

D	E	F	G	H	J	K _{COM}	L	M	N	O	P	Q	R	S	T	U	(# above U) *	S Nail	M Nail
1344	1350	1356	1362	1368	1374	1380	1386	1392	1398	1404	1410	1416	1422	1428	1434	1440	6 (Riser) + 1440 (U)	N/A	N/A

8762-A2

Standard Pillows: N/A **Finish Req:** Y
Standard Cushions: High Resiliency 40 **Standard Finish:** N/A
COM: 2.5 yards

Laguna Occasional Chair

Width: 24 **Depth:** 23 **Height:** 36.5
AH: 25.5 **SH:** 19.5 **SD:** 18 **IW:** 20.5
Weight: 35 / 40 lbs **Cube:** 15.74

D	E	F	G	H	J	K _{COM}	L	M	N	O	P	Q	R	S	T	U	(# above U) *	S Nail	M Nail
1440	1449	1458	1467	1476	1485	1494	1503	1512	1521	1530	1539	1548	1557	1566	1575	1584	9 (Riser) + 1584 (U)	N/A	N/A

8762-E1

Standard Pillows: N/A **Finish Req:** Y
Standard Cushions: High Resiliency 40 **Standard Finish:** N/A
COM: 2.5 yards
 Features an EasyClean Seat.

Laguna EasyClean Occasional Chair

Width: 24 **Depth:** 23 **Height:** 36.5
AH: 25.5 **SH:** 19 **SD:** 18 **IW:** 20.5
Weight: 35 / 40 lbs **Cube:** 15.74

D	E	F	G	H	J	K _{COM}	L	M	N	O	P	Q	R	S	T	U	(# above U) *	S Nail	M Nail
1422	1431	1440	1449	1458	1467	1476	1485	1494	1503	1512	1521	1530	1539	1548	1557	1566	9 (Riser) + 1566 (U)	N/A	N/A

8762-E2

Standard Pillows: N/A **Finish Req:** Y
Standard Cushions: High Resiliency 40 **Standard Finish:** N/A
COM: 2.5 yards
 Features an EasyClean Seat.

Laguna EasyClean Occasional Chair with Front Casters

Width: 24 **Depth:** 23 **Height:** 36.5
AH: 25.5 **SH:** 19.5 **SD:** 18 **IW:** 20.5
Weight: 35 / 40 lbs **Cube:** 15.74

D	E	F	G	H	J	K _{COM}	L	M	N	O	P	Q	R	S	T	U	(# above U) *	S Nail	M Nail
1458	1467	1476	1485	1494	1503	1512	1521	1530	1539	1548	1557	1566	1575	1584	1593	1602	9 (Riser) + 1602 (U)	N/A	N/A

UPHOLSTERY

8762-E4

Laguna EasyClean Occasional Chair with Four Casters

Standard Pillows: N/A **Finish Req:** Y
Standard Cushions: High Resiliency 40 **Standard Finish:** N/A
COM: 2.5 yards
 Features an EasyClean Seat.

Width: 24 **Depth:** 23 **Height:** 36.5
AH: 25.5 **SH:** 19.5 **SD:** 18 **IW:** 20.5
Weight: 35 / 40 lbs **Cube:** 15.74

D	E	F	G	H	J	K _{COM}	L	M	N	O	P	Q	R	S	T	U	(# above U) *	S Nail	M Nail
1494	1503	1512	1521	1530	1539	1548	1557	1566	1575	1584	1593	1602	1611	1620	1629	1638	9 (Riser) + 1638 (U)	N/A	N/A

8762-01

Laguna Occasional Chair

Standard Pillows: N/A **Finish Req:** Y
Standard Cushions: High Resiliency 40 **Standard Finish:** N/A
COM: 2.5 yards

Width: 24 **Depth:** 23 **Height:** 36.5
AH: 25.5 **SH:** 19.5 **SD:** 18 **IW:** 20.5
Weight: 35 / 40 lbs **Cube:** 15.74

D	E	F	G	H	J	K _{COM}	L	M	N	O	P	Q	R	S	T	U	(# above U) *	S Nail	M Nail
1404	1413	1422	1431	1440	1449	1458	1467	1476	1485	1494	1503	1512	1521	1530	1539	1548	9 (Riser) + 1548 (U)	N/A	N/A

8764-A2

Perkins Occasional Chair

Standard Pillows: N/A **Finish Req:** Y
Standard Cushions: High Resiliency 40 **Standard Finish:** N/A
COM: 3.75 yards

Width: 26.5 **Depth:** 28.5 **Height:** 39.5
AH: 25.5 **SH:** 19.5 **SD:** 18.5 **IW:** 20
Weight: 35 / 40 lbs **Cube:** 21.65

D	E	F	G	H	J	K _{COM}	L	M	N	O	P	Q	R	S	T	U	(# above U) *	S Nail	M Nail
1674	1686	1698	1710	1722	1734	1746	1758	1770	1782	1794	1806	1818	1830	1842	1854	1866	12 (Riser) + 1866 (U)	45	60

8764-E1

Perkins EasyClean Occasional Chair

Standard Pillows: N/A **Finish Req:** Y
Standard Cushions: High Resiliency 40 **Standard Finish:** N/A
COM: 3.75 yards

Width: 26.5 **Depth:** 28.5 **Height:** 39.5
AH: 25.5 **SH:** 19.5 **SD:** 18.5 **IW:** 20
Weight: 35 / 40 lbs **Cube:** 21.65

D	E	F	G	H	J	K _{COM}	L	M	N	O	P	Q	R	S	T	U	(# above U) *	S Nail	M Nail
1665	1677	1689	1701	1713	1725	1737	1749	1761	1773	1785	1797	1809	1821	1833	1845	1857	12 (Riser) + 1857 (U)	45	60

8764-E2

Perkins EasyClean Occasional Chair with Front Casters

Standard Pillows: N/A **Finish Req:** Y
Standard Cushions: High Resiliency 40 **Standard Finish:** N/A
COM: 3.75 yards
 Features an EasyClean Seat.

Width: 26.5 **Depth:** 28.5 **Height:** 39.5
AH: 25.5 **SH:** 19.5 **SD:** 18.5 **IW:** 20
Weight: 35 / 40 lbs **Cube:** 21.65

D	E	F	G	H	J	K _{COM}	L	M	N	O	P	Q	R	S	T	U	(# above U) *	S Nail	M Nail
1701	1713	1725	1737	1749	1761	1773	1785	1797	1809	1821	1833	1845	1857	1869	1881	1893	12 (Riser) + 1893 (U)	45	60

8764-01

Perkins Occasional Chair

Standard Pillows: N/A **Finish Req:** Y
Standard Cushions: High Resiliency 40 **Standard Finish:** N/A
COM: 3.75 yards

Width: 26.5 **Depth:** 28.5 **Height:** 39.5
AH: 25.5 **SH:** 19.5 **SD:** 18.5 **IW:** 20
Weight: 35 / 40 lbs **Cube:** 21.65

D	E	F	G	H	J	K _{COM}	L	M	N	O	P	Q	R	S	T	U	(# above U) *	S Nail	M Nail
1632	1644	1656	1668	1680	1692	1704	1716	1728	1740	1752	1764	1776	1788	1800	1812	1824	12 (Riser) + 1824 (U)	45	60

8769-A2

Jennifer Arm Chair

Standard Pillows: N/A **Finish Req:** Y
Standard Cushions: High Resiliency 55 **Standard Finish:** N/A
COM: 2 yards

Width: 24.5 **Depth:** 27 **Height:** 40
AH: 26.5 **SH:** 19 **SD:** 18.5 **IW:** 21
Weight: 35 / 40 lbs **Cube:** 21.65

D	E	F	G	H	J	K _{COM}	L	M	N	O	P	Q	R	S	T	U	(# above U) *	S Nail	M Nail
1326	1332	1338	1344	1350	1356	1362	1368	1374	1380	1386	1392	1398	1404	1410	1416	1422	6 (Riser) + 1422 (U)	N/A	N/A

UPHOLSTERY

8769-A4

Standard Pillows: N/A **Finish Req:** Y
Standard Cushions: High Resiliency 55 **Standard Finish:** N/A
COM: 2 yards

Jennifer Arm Chair

Width: 24.5 **Depth:** 27 **Height:** 40
AH: 26.5 **SH:** 20 **SD:** 19 **IW:** 21
Weight: 35 / 40 lbs **Cube:** 21.65

D	E	F	G	H	J	K COM	L	M	N	O	P	Q	R	S	T	U	(# above U) *	S Nail	M Nail
1362	1368	1374	1380	1386	1392	1398	1404	1410	1416	1422	1428	1434	1440	1446	1452	1458	6 (Riser) + 1458 (U)	N/A	N/A

8769-04

Standard Pillows: N/A **Finish Req:** Y
Standard Cushions: High Resiliency 55 **Standard Finish:** N/A
COM: 2 yards

Jennifer Arm Chair

Width: 24.5 **Depth:** 27 **Height:** 40
AH: 26.5 **SH:** 19 **SD:** 18.5 **IW:** 21
Weight: 30 / 35 lbs **Cube:** 17.77

D	E	F	G	H	J	K COM	L	M	N	O	P	Q	R	S	T	U	(# above U) *	S Nail	M Nail
1290	1296	1302	1308	1314	1320	1326	1332	1338	1344	1350	1356	1362	1368	1374	1380	1386	6 (Riser) + 1386 (U)	N/A	N/A

8770-04

Standard Pillows: N/A **Finish Req:** Y
Standard Cushions: High Resiliency 40 **Standard Finish:** N/A
COM: 2 yards

Laughlin Arm Chair

Width: 22 **Depth:** 23.5 **Height:** 36.5
AH: 26.5 **SH:** 18.5 **SD:** 18 **IW:** 20
Weight: 25 / 30 lbs **Cube:** 15.74

D	E	F	G	H	J	K COM	L	M	N	O	P	Q	R	S	T	U	(# above U) *	S Nail	M Nail
1125	1131	1137	1143	1149	1155	1161	1167	1173	1179	1185	1191	1197	1203	1209	1215	1221	6 (Riser) + 1221 (U)	N/A	N/A

8771-A4

Standard Pillows: N/A **Finish Req:** Y
Standard Cushions: High Resiliency 40 **Standard Finish:** N/A
COM: 2 yards

Mapleton Arm Chair

Width: 24 **Depth:** 23 **Height:** 37.5
AH: 26.5 **SH:** 18.5 **SD:** 18 **IW:** 20
Weight: 30 / 35 lbs **Cube:** 15.74

D	E	F	G	H	J	K COM	L	M	N	O	P	Q	R	S	T	U	(# above U) *	S Nail	M Nail
1260	1266	1272	1278	1284	1290	1296	1302	1308	1314	1320	1326	1332	1338	1344	1350	1356	6 (Riser) + 1356 (U)	N/A	N/A

8771-04

Standard Pillows: N/A **Finish Req:** Y
Standard Cushions: High Resiliency 40 **Standard Finish:** N/A
COM: 2 yards

Mapleton Arm Chair

Width: 24 **Depth:** 23 **Height:** 37.5
AH: 26.5 **SH:** 18.5 **SD:** 18 **IW:** 20
Weight: 25 / 35 lbs **Cube:** 15.74

D	E	F	G	H	J	K COM	L	M	N	O	P	Q	R	S	T	U	(# above U) *	S Nail	M Nail
1125	1131	1137	1143	1149	1155	1161	1167	1173	1179	1185	1191	1197	1203	1209	1215	1221	6 (Riser) + 1221 (U)	N/A	N/A

8772-A4

Standard Pillows: N/A **Finish Req:** Y
Standard Cushions: High Resiliency 40 **Standard Finish:** N/A
COM: 2 yards

Naples Arm Chair

Width: 22.5 **Depth:** 24 **Height:** 33
AH: 25.5 **SH:** 19 **SD:** 19 **IW:** 19.5
Weight: 30 / 35 lbs **Cube:** 15.74

D	E	F	G	H	J	K COM	L	M	N	O	P	Q	R	S	T	U	(# above U) *	S Nail	M Nail
1314	1320	1326	1332	1338	1344	1350	1356	1362	1368	1374	1380	1386	1392	1398	1404	1410	6 (Riser) + 1410 (U)	45	N/A

8772-04

Standard Pillows: N/A **Finish Req:** Y
Standard Cushions: High Resiliency 40 **Standard Finish:** N/A
COM: 2 yards

Naples Arm Chair

Width: 22.5 **Depth:** 24 **Height:** 33
AH: 25.5 **SH:** 19 **SD:** 19 **IW:** 19.5
Weight: 30 / 35 lbs **Cube:** 15.74

D	E	F	G	H	J	K COM	L	M	N	O	P	Q	R	S	T	U	(# above U) *	S Nail	M Nail
1242	1248	1254	1260	1266	1272	1278	1284	1290	1296	1302	1308	1314	1320	1326	1332	1338	6 (Riser) + 1338 (U)	45	N/A

UPHOLSTERY

8773-04

Carla Arm Chair

Standard Pillows: N/A **Finish Req:** Y
Standard Cushions: High Resiliency 40 **Standard Finish:** N/A
COM: 5.5 yards

Width: 24.5 **Depth:** 29 **Height:** 44
AH: 24 **SH:** 21 **SD:** 18.5 **IW:** 19
Weight: 40 / 53 lbs **Cube:** 24.14

D	E	F	G	H	J	K _{COM}	L	M	N	O	P	Q	R	S	T	U	(# above U) *	S Nail	M Nail
1650	1665	1680	1695	1710	1725	1740	1755	1770	1785	1800	1815	1830	1845	1860	1875	1890	15 (Riser) + 1890 (U)	60	75

8773-05

Carla Side Chair

Standard Pillows: N/A **Finish Req:** Y
Standard Cushions: High Resiliency 40 **Standard Finish:** N/A
COM: 4.75 yards

Width: 21 **Depth:** 29.5 **Height:** 44.5
AH: - **SH:** 20 **SD:** 18 **IW:** 20
Weight: 30 / 45 lbs **Cube:** 24.14

D	E	F	G	H	J	K _{COM}	L	M	N	O	P	Q	R	S	T	U	(# above U) *	S Nail	M Nail
1560	1575	1590	1605	1620	1635	1650	1665	1680	1695	1710	1725	1740	1755	1770	1785	1800	15 (Riser) + 1800 (U)	60	75

8774-05

Charlotte Side Chair

Standard Pillows: N/A **Finish Req:** N
Standard Cushions: High Resiliency 40 **Standard Finish:** traditional
COM: 5.5 yards

Width: 21 **Depth:** 29.5 **Height:** 44.5
AH: - **SH:** 20 **SD:** 18 **IW:** 20
Weight: 31 / 44 lbs **Cube:** 21.65

D	E	F	G	H	J	K _{COM}	L	M	N	O	P	Q	R	S	T	U	(# above U) *	S Nail	M Nail
1725	1743	1761	1779	1797	1815	1833	1851	1869	1887	1905	1923	1941	1959	1977	1995	2013	18 (Riser) + 2013 (U)	45	60

8778-A4

Pryor Arm Chair

Standard Pillows: N/A **Finish Req:** Y
Standard Cushions: High Resiliency 40 **Standard Finish:** N/A
COM: 2 yards

Width: 24.5 **Depth:** 24.5 **Height:** 38.5
AH: 26.5 **SH:** 19 **SD:** 18 **IW:** 19.5
Weight: 30 / 35 lbs **Cube:** 15.74

D	E	F	G	H	J	K _{COM}	L	M	N	O	P	Q	R	S	T	U	(# above U) *	S Nail	M Nail
1362	1368	1374	1380	1386	1392	1398	1404	1410	1416	1422	1428	1434	1440	1446	1452	1458	6 (Riser) + 1458 (U)	N/A	N/A

8778-04

Pryor Arm Chair

Standard Pillows: N/A **Finish Req:** Y
Standard Cushions: High Resiliency 40 **Standard Finish:** N/A
COM: 2 yards

Width: 24.5 **Depth:** 24.5 **Height:** 38.5
AH: 26.5 **SH:** 19 **SD:** 18 **IW:** 19.5
Weight: 30 / 35 lbs **Cube:** 15.74

D	E	F	G	H	J	K _{COM}	L	M	N	O	P	Q	R	S	T	U	(# above U) *	S Nail	M Nail
1290	1296	1302	1308	1314	1320	1326	1332	1338	1344	1350	1356	1362	1368	1374	1380	1386	6 (Riser) + 1386 (U)	N/A	N/A

8779-A4

Hughes Arm Chair

Standard Pillows: N/A **Finish Req:** Y
Standard Cushions: High Resiliency 40 **Standard Finish:** N/A
COM: 2 yards

Width: 23 **Depth:** 24 **Height:** 39.5
AH: 27 **SH:** 20 **SD:** 17.5 **IW:** 20
Weight: 23 / 34 lbs **Cube:** 17.77

D	E	F	G	H	J	K _{COM}	L	M	N	O	P	Q	R	S	T	U	(# above U) *	S Nail	M Nail
1362	1368	1374	1380	1386	1392	1398	1404	1410	1416	1422	1428	1434	1440	1446	1452	1458	6 (Riser) + 1458 (U)	45	N/A

8779-04

Hughes Arm Chair

Standard Pillows: N/A **Finish Req:** Y
Standard Cushions: High Resiliency 40 **Standard Finish:** N/A
COM: 2 yards

Width: 23 **Depth:** 24 **Height:** 39.5
AH: 27 **SH:** 20 **SD:** 17.5 **IW:** 20
Weight: 22 / 33 lbs **Cube:** 15.74

D	E	F	G	H	J	K _{COM}	L	M	N	O	P	Q	R	S	T	U	(# above U) *	S Nail	M Nail
1290	1296	1302	1308	1314	1320	1326	1332	1338	1344	1350	1356	1362	1368	1374	1380	1386	6 (Riser) + 1386 (U)	45	N/A

UPHOLSTERY

8780-A4

Standard Pillows: N/A **Finish Req:** Y
Standard Cushions: High Resiliency 40 **Standard Finish:** N/A
COM: 2 yards

Oakland Arm Chair

Width: 23 **Depth:** 24 **Height:** 37.5
AH: 25.5 **SH:** 19 **SD:** 18 **IW:** 20.5
Weight: 31 / 41 lbs **Cube:** 17.77

D	E	F	G	H	J	K COM	L	M	N	O	P	Q	R	S	T	U	(# above U) *	S Nail	M Nail
1437	1443	1449	1455	1461	1467	1473	1479	1485	1491	1497	1503	1509	1515	1521	1527	1533	6 (Riser) + 1533 (U)	45	N/A

8780-04

Standard Pillows: N/A **Finish Req:** Y
Standard Cushions: High Resiliency 40 **Standard Finish:** N/A
COM: 2 yards

Oakland Arm Chair

Width: 23 **Depth:** 24 **Height:** 37.5
AH: 25.5 **SH:** 19 **SD:** 18 **IW:** 20.5
Weight: 30 / 35 lbs **Cube:** 15.74

D	E	F	G	H	J	K COM	L	M	N	O	P	Q	R	S	T	U	(# above U) *	S Nail	M Nail
1365	1371	1377	1383	1389	1395	1401	1407	1413	1419	1425	1431	1437	1443	1449	1455	1461	6 (Riser) + 1461 (U)	45	N/A

8783-11

Standard Pillows: N/A **Finish Req:** Y
Standard Cushions: High Resiliency 40 **Standard Finish:** N/A
COM: 2 yards
 Available in FairShield Plus Finishes Only. Warranted for stacking three high.

Oakridge Arm Stack Chair

Width: 23 **Depth:** 24 **Height:** 37.5
AH: 25.5 **SH:** 19 **SD:** 18.5 **IW:** 20
Weight: 30 / 35 lbs **Cube:** 15.74

D	E	F	G	H	J	K COM	L	M	N	O	P	Q	R	S	T	U	(# above U) *	S Nail	M Nail
1230	1236	1242	1248	1254	1260	1266	1272	1278	1284	1290	1296	1302	1308	1314	1320	1326	6 (Riser) + 1326 (U)	N/A	N/A

8784-A4

Standard Pillows: N/A **Finish Req:** Y
Standard Cushions: High Resiliency 40 **Standard Finish:** N/A
COM: 4.25 yards

Hayley Arm Chair

Width: 27 **Depth:** 24.5 **Height:** 30.5
AH: 25 **SH:** 19.5 **SD:** 20 **IW:** 19
Weight: 35 / 40 lbs **Cube:** 21.65

D	E	F	G	H	J	K COM	L	M	N	O	P	Q	R	S	T	U	(# above U) *	S Nail	M Nail
2082	2094	2106	2118	2130	2142	2154	2166	2178	2190	2202	2214	2226	2238	2250	2262	2274	12 (Riser) + 2274 (U)	75	90

8784-04

Standard Pillows: N/A **Finish Req:** Y
Standard Cushions: High Resiliency 40 **Standard Finish:** N/A
COM: 4.25 yards

Hayley Arm Chair

Width: 27 **Depth:** 24.5 **Height:** 30.5
AH: 25 **SH:** 19.5 **SD:** 20 **IW:** 19
Weight: 35 / 40 lbs **Cube:** 21.65

D	E	F	G	H	J	K COM	L	M	N	O	P	Q	R	S	T	U	(# above U) *	S Nail	M Nail
2010	2022	2034	2046	2058	2070	2082	2094	2106	2118	2130	2142	2154	2166	2178	2190	2202	12 (Riser) + 2202 (U)	75	90

8784-1N

Standard Pillows: N/A **Finish Req:** N
Standard Cushions: High Resiliency 40 **Standard Finish:** Nickel
COM: 4.25 yards
 Features Swivel Nickel Base with Casters

Hayley Task Chair

Width: 27 **Depth:** 25.5 **Height:** 31.25
AH: 27.75 **SH:** 20.75 **SD:** 21.5 **IW:** 19
Weight: 41 / 54 lbs **Cube:** 21.65

D	E	F	G	H	J	K COM	L	M	N	O	P	Q	R	S	T	U	(# above U) *	S Nail	M Nail
2295	2307	2319	2331	2343	2355	2367	2379	2391	2403	2415	2427	2439	2451	2463	2475	2487	12 (Riser) + 2487 (U)	N/A	N/A

8784-2N

Standard Pillows: N/A **Finish Req:** N
Standard Cushions: High Resiliency 40 **Standard Finish:** Nickel
COM: 4.25 yards
 Features Stationary Nickel Plated Base with a gas cylinder.

Hayley Swivel Chair

Width: 27 **Depth:** 25.5 **Height:** 28.75
AH: 26.25 **SH:** 19.25 **SD:** 21.5 **IW:** 19
Weight: 40 / 53 lbs **Cube:** 21.65

D	E	F	G	H	J	K COM	L	M	N	O	P	Q	R	S	T	U	(# above U) *	S Nail	M Nail
2295	2307	2319	2331	2343	2355	2367	2379	2391	2403	2415	2427	2439	2451	2463	2475	2487	12 (Riser) + 2487 (U)	N/A	N/A

UPHOLSTERY

8788-A4

Standard Pillows: N/A **Finish Req:** Y
Standard Cushions: High Resiliency 40 **Standard Finish:** N/A
COM: 2 yards

Oakwood Arm Chair

Width: 23 **Depth:** 24 **Height:** 40
AH: 25.5 **SH:** 19 **SD:** 19 **IW:** 20
Weight: 30 / 35 lbs **Cube:** 15.74

D	E	F	G	H	J	K _{COM}	L	M	N	O	P	Q	R	S	T	U	(# above U) *	S Nail	M Nail
1392	1398	1404	1410	1416	1422	1428	1434	1440	1446	1452	1458	1464	1470	1476	1482	1488	6 (Riser) + 1488 (U)	45	N/A

8788-04

Standard Pillows: N/A **Finish Req:** Y
Standard Cushions: High Resiliency 40 **Standard Finish:** N/A
COM: 2 yards

Oakwood Arm Chair

Width: 23 **Depth:** 24 **Height:** 37.5
AH: 25.5 **SH:** 19 **SD:** 19 **IW:** 20
Weight: 30 / 35 lbs **Cube:** 15.74

D	E	F	G	H	J	K _{COM}	L	M	N	O	P	Q	R	S	T	U	(# above U) *	S Nail	M Nail
1320	1326	1332	1338	1344	1350	1356	1362	1368	1374	1380	1386	1392	1398	1404	1410	1416	6 (Riser) + 1416 (U)	45	N/A

8790-A4

Standard Pillows: N/A **Finish Req:** Y
Standard Cushions: High Resiliency 40 **Standard Finish:** N/A
COM: 2 yards

Hopkins Arm Chair

Width: 24 **Depth:** 25.5 **Height:** 38
AH: 26 **SH:** 19 **SD:** 19 **IW:** 20
Weight: 35 / 40 lbs **Cube:** 15.74

D	E	F	G	H	J	K _{COM}	L	M	N	O	P	Q	R	S	T	U	(# above U) *	S Nail	M Nail
1362	1368	1374	1380	1386	1392	1398	1404	1410	1416	1422	1428	1434	1440	1446	1452	1458	6 (Riser) + 1458 (U)	45	60

8790-04

Standard Pillows: N/A **Finish Req:** Y
Standard Cushions: High Resiliency 40 **Standard Finish:** N/A
COM: 2 yards

Hopkins Arm Chair

Width: 24 **Depth:** 25.5 **Height:** 38
AH: 26 **SH:** 19 **SD:** 19 **IW:** 20
Weight: 35 / 40 lbs **Cube:** 15.74

D	E	F	G	H	J	K _{COM}	L	M	N	O	P	Q	R	S	T	U	(# above U) *	S Nail	M Nail
1290	1296	1302	1308	1314	1320	1326	1332	1338	1344	1350	1356	1362	1368	1374	1380	1386	6 (Riser) + 1386 (U)	45	60

8794-BB

Standard Pillows: N/A **Finish Req:** Y
Standard Cushions: High Resiliency 55 **Standard Finish:** N/A
COM: 4.25 yards

Bryant Bar Bench

Width: 56.25 **Depth:** 23 **Height:** 42
AH: 37 **SH:** 30 **SD:** 19 **IW:** 50
Weight: 50 / 75 lbs **Cube:** 44.07

D	E	F	G	H	J	K _{COM}	L	M	N	O	P	Q	R	S	T	U	(# above U) *	S Nail	M Nail
2667	2679	2691	2703	2715	2727	2739	2751	2763	2775	2787	2799	2811	2823	2835	2847	2859	12 (Riser) + 2859 (U)	120	N/A

8794-CB

Standard Pillows: N/A **Finish Req:** Y
Standard Cushions: High Resiliency 55 **Standard Finish:** N/A
COM: 4.25 yards

Bryant Counter Bench

Width: 56.25 **Depth:** 23 **Height:** 38
AH: 33 **SH:** 26 **SD:** 19 **IW:** 50
Weight: 40 / 60 lbs **Cube:** 29.96

D	E	F	G	H	J	K _{COM}	L	M	N	O	P	Q	R	S	T	U	(# above U) *	S Nail	M Nail
2667	2679	2691	2703	2715	2727	2739	2751	2763	2775	2787	2799	2811	2823	2835	2847	2859	12 (Riser) + 2859 (U)	120	N/A

8794-C6

Standard Pillows: N/A **Finish Req:** Y
Standard Cushions: High Resiliency 55 **Standard Finish:** N/A
COM: 3.25 yards

Bryant Counter Stool

Width: 24 **Depth:** 23 **Height:** 38
AH: 33 **SH:** 26 **SD:** 19 **IW:** 17.5
Weight: 30 / 35 lbs **Cube:** 15.74

D	E	F	G	H	J	K _{COM}	L	M	N	O	P	Q	R	S	T	U	(# above U) *	S Nail	M Nail
1785	1794	1803	1812	1821	1830	1839	1848	1857	1866	1875	1884	1893	1902	1911	1920	1929	9 (Riser) + 1929 (U)	75	N/A

UPHOLSTERY

8794-M6

Standard Pillows: N/A **Finish Req:** N
Standard Cushions: High Resiliency 55 **Standard Finish:** Nickel
COM: 3.25 yards

Bryant Multi-Height Bar Stool

Width: 24 **Depth:** 23 **Height:** 38.5
AH: - **SH:** - **SD:** 19 **IW:** 17.5
Weight: 43 / 53 lbs **Cube:** 15.74

D	E	F	G	H	J	K COM	L	M	N	O	P	Q	R	S	T	U	(# above U) *	S Nail	M Nail
2550	2559	2568	2577	2586	2595	2604	2613	2622	2631	2640	2649	2658	2667	2676	2685	2694	9 (Riser) + 2694 (U)	75	N/A

8794-04

Standard Pillows: N/A **Finish Req:** Y
Standard Cushions: High Resiliency 55 **Standard Finish:** N/A
COM: 3.25 yards

Bryant Arm Chair

Width: 24 **Depth:** 23 **Height:** 32
AH: 27 **SH:** 19.5 **SD:** 19 **IW:** 17.5
Weight: 25 / 35 lbs **Cube:** 15.74

D	E	F	G	H	J	K COM	L	M	N	O	P	Q	R	S	T	U	(# above U) *	S Nail	M Nail
1680	1689	1698	1707	1716	1725	1734	1743	1752	1761	1770	1779	1788	1797	1806	1815	1824	9 (Riser) + 1824 (U)	75	N/A

8794-06

Standard Pillows: N/A **Finish Req:** Y
Standard Cushions: High Resiliency 55 **Standard Finish:** N/A
COM: 3.25 yards

Bryant Bar Stool

Width: 24 **Depth:** 23 **Height:** 42
AH: 37 **SH:** 30 **SD:** 19 **IW:** 17.5
Weight: 35 / 45 lbs **Cube:** 19.6

D	E	F	G	H	J	K COM	L	M	N	O	P	Q	R	S	T	U	(# above U) *	S Nail	M Nail
1785	1794	1803	1812	1821	1830	1839	1848	1857	1866	1875	1884	1893	1902	1911	1920	1929	9 (Riser) + 1929 (U)	75	N/A

8794-1N

Standard Pillows: N/A **Finish Req:** N
Standard Cushions: High Resiliency 55 **Standard Finish:** Nickel
COM: 3.25 yards
 Features Swivel Nickel Base with Casters

Bryant Task Chair

Width: 24 **Depth:** 24 **Height:** 31.5
AH: 27.5 **SH:** 20.5 **SD:** 19 **IW:** 17.5
Weight: 40 / 50 lbs **Cube:** 21.65

D	E	F	G	H	J	K COM	L	M	N	O	P	Q	R	S	T	U	(# above U) *	S Nail	M Nail
1890	1899	1908	1917	1926	1935	1944	1953	1962	1971	1980	1989	1998	2007	2016	2025	2034	9 (Riser) + 2034 (U)	75	N/A

8794-2N

Standard Pillows: N/A **Finish Req:** N
Standard Cushions: High Resiliency 55 **Standard Finish:** Nickel
COM: 3.25 yards
 Features Stationary Nickel Plated Base with a gas cylinder.

Bryant Swivel Chair

Width: 24 **Depth:** 24 **Height:** 30
AH: 26 **SH:** 19 **SD:** 19 **IW:** 17.5
Weight: 40 / 50 lbs **Cube:** 15.74

D	E	F	G	H	J	K COM	L	M	N	O	P	Q	R	S	T	U	(# above U) *	S Nail	M Nail
1890	1899	1908	1917	1926	1935	1944	1953	1962	1971	1980	1989	1998	2007	2016	2025	2034	9 (Riser) + 2034 (U)	75	N/A

8794-40

Standard Pillows: N/A **Finish Req:** Y
Standard Cushions: HR-55 DAC **Standard Finish:** N/A
COM: 4 yards

Bryant Settee

Width: 56.25 **Depth:** 23 **Height:** 32
AH: 27 **SH:** 19.5 **SD:** 19 **IW:** 50
Weight: 52 / 82 lbs **Cube:** 55.51

D	E	F	G	H	J	K COM	L	M	N	O	P	Q	R	S	T	U	(# above U) *	S Nail	M Nail
2640	2652	2664	2676	2688	2700	2712	2724	2736	2748	2760	2772	2784	2796	2808	2820	2832	12 (Riser) + 2832 (U)	120	N/A

8795-E1

Standard Pillows: N/A **Finish Req:** Y
Standard Cushions: High Resiliency 40 **Standard Finish:** N/A
COM: 3.75 yards
 Features an EasyClean Seat

Atkinson EasyClean Occasional Chair

Width: 26 **Depth:** 28 **Height:** 39.5
AH: 26 **SH:** 19.5 **SD:** 18 **IW:** 19
Weight: 36 / 49 lbs **Cube:** 21.65

D	E	F	G	H	J	K COM	L	M	N	O	P	Q	R	S	T	U	(# above U) *	S Nail	M Nail
1680	1692	1704	1716	1728	1740	1752	1764	1776	1788	1800	1812	1824	1836	1848	1860	1872	12 (Riser) + 1872 (U)	45	60

UPHOLSTERY

8796-04

Standard Pillows: N/A **Finish Req:** Y
Standard Cushions: High Resiliency 40 **Standard Finish:** N/A
COM: 2 yards

Gates Arm Chair

Width: 23 **Depth:** 24 **Height:** 34.5
AH: 25 **SH:** 20 **SD:** 19.5 **IW:** 19.5
Weight: 25 / 35 lbs **Cube:** 15.74

D	E	F	G	H	J	K _{COM}	L	M	N	O	P	Q	R	S	T	U	(# above U) *	S Nail	M Nail
1422	1428	1434	1440	1446	1452	1458	1464	1470	1476	1482	1488	1494	1500	1506	1512	1518	6 (Riser) + 1518 (U)	N/A	N/A

8801-A2

Standard Pillows: N/A **Finish Req:** Y
Standard Cushions: High Resiliency 40 **Standard Finish:** N/A
COM: 2.25 yards
 Standard with 2 front casters and features a hidden handle

Stella Arm Chair

Width: 24.25 **Depth:** 28 **Height:** 38.5
AH: 25 **SH:** 19.75 **SD:** 18.5 **IW:** 20.25
Weight: 23 / 33 lbs **Cube:** 15.12

D	E	F	G	H	J	K _{COM}	L	M	N	O	P	Q	R	S	T	U	(# above U) *	S Nail	M Nail
1458	1467	1476	1485	1494	1503	1512	1521	1530	1539	1548	1557	1566	1575	1584	1593	1602	9 (Riser) + 1602 (U)	45	N/A

8801-A4

Standard Pillows: N/A **Finish Req:** Y
Standard Cushions: High Resiliency 40 **Standard Finish:** N/A
COM: 2.25 yards
 Standard with casters on all legs and features a hidden handle

Stella Arm Chair

Width: 24.25 **Depth:** 28 **Height:** 38.5
AH: 25 **SH:** 19.75 **SD:** 18.5 **IW:** 20.25
Weight: 23 / 33 lbs **Cube:** 15.12

D	E	F	G	H	J	K _{COM}	L	M	N	O	P	Q	R	S	T	U	(# above U) *	S Nail	M Nail
1494	1503	1512	1521	1530	1539	1548	1557	1566	1575	1584	1593	1602	1611	1620	1629	1638	9 (Riser) + 1638 (U)	45	N/A

8801-04

Standard Pillows: N/A **Finish Req:** Y
Standard Cushions: High Resiliency 40 **Standard Finish:** N/A
COM: 2.25 yards
 Features a hidden handle

Stella Arm Chair

Width: 24.25 **Depth:** 28 **Height:** 38.5
AH: 25 **SH:** 19.75 **SD:** 18.5 **IW:** 20.25
Weight: 23 / 33 lbs **Cube:** 15.74

D	E	F	G	H	J	K _{COM}	L	M	N	O	P	Q	R	S	T	U	(# above U) *	S Nail	M Nail
1422	1431	1440	1449	1458	1467	1476	1485	1494	1503	1512	1521	1530	1539	1548	1557	1566	9 (Riser) + 1566 (U)	45	N/A

8810-04

Standard Pillows: N/A **Finish Req:** Y
Standard Cushions: High Resiliency 40 **Standard Finish:** N/A
COM: 2 yards

Walsh Arm Chair

Width: 23.5 **Depth:** 26 **Height:** 40
AH: 25 **SH:** 19 **SD:** 19 **IW:** 20
Weight: 23 / 34 lbs **Cube:** 15.74

D	E	F	G	H	J	K _{COM}	L	M	N	O	P	Q	R	S	T	U	(# above U) *	S Nail	M Nail
1302	1308	1314	1320	1326	1332	1338	1344	1350	1356	1362	1368	1374	1380	1386	1392	1398	6 (Riser) + 1398 (U)	N/A	N/A

8810-05

Standard Pillows: N/A **Finish Req:** Y
Standard Cushions: High Resiliency 40 **Standard Finish:** N/A
COM: 2 yards

Walsh Side Chair

Width: 22.75 **Depth:** 24 **Height:** 40
AH: - **SH:** 19.25 **SD:** 19 **IW:** 22.5
Weight: 20 / 31 lbs **Cube:** 17.77

D	E	F	G	H	J	K _{COM}	L	M	N	O	P	Q	R	S	T	U	(# above U) *	S Nail	M Nail
1272	1278	1284	1290	1296	1302	1308	1314	1320	1326	1332	1338	1344	1350	1356	1362	1368	6 (Riser) + 1368 (U)	N/A	N/A

8812-05

Standard Pillows: N/A **Finish Req:** Y
Standard Cushions: High Resiliency 40 **Standard Finish:** N/A
COM: 2 yards

Barkley Side Chair

Width: 23 **Depth:** 23 **Height:** 38.5
AH: - **SH:** 20 **SD:** 18.25 **IW:** 23
Weight: 19 / 29 lbs **Cube:** 15.74

D	E	F	G	H	J	K _{COM}	L	M	N	O	P	Q	R	S	T	U	(# above U) *	S Nail	M Nail
1305	1311	1317	1323	1329	1335	1341	1347	1353	1359	1365	1371	1377	1383	1389	1395	1401	6 (Riser) + 1401 (U)	45	60

UPHOLSTERY

8818-04

Standard Pillows: N/A **Finish Req:** Y
Standard Cushions: High Resiliency 40 **Standard Finish:** N/A
COM: 2 yards

Wilborn Arm Chair

Width: 23.5 **Depth:** 26.25 **Height:** 38.5
AH: 25 **SH:** 19 **SD:** 19.25 **IW:** 20.25
Weight: 21 / 31 lbs **Cube:** 15.74

D	E	F	G	H	J	K _{COM}	L	M	N	O	P	Q	R	S	T	U	(# above U) *	S Nail	M Nail
1248	1254	1260	1266	1272	1278	1284	1290	1296	1302	1308	1314	1320	1326	1332	1338	1344	6 (Riser) + 1344 (U)	45	N/A

8819-A2

Standard Pillows: N/A **Finish Req:** Y
Standard Cushions: High Resiliency 40 **Standard Finish:** N/A
COM: 2 yards

Kennedy Arm Chair

Width: 24 **Depth:** 25.5 **Height:** 38.25
AH: 25.5 **SH:** 19.5 **SD:** 19 **IW:** 20.25
Weight: 32 / 32 lbs **Cube:** 15.74

D	E	F	G	H	J	K _{COM}	L	M	N	O	P	Q	R	S	T	U	(# above U) *	S Nail	M Nail
1338	1344	1350	1356	1362	1368	1374	1380	1386	1392	1398	1404	1410	1416	1422	1428	1434	6 (Riser) + 1434 (U)	45	N/A

8819-A4

Standard Pillows: N/A **Finish Req:** Y
Standard Cushions: High Resiliency 40 **Standard Finish:** N/A
COM: 2 yards

Kennedy Arm Chair

Width: 24 **Depth:** 25.5 **Height:** 38.25
AH: 25.5 **SH:** 19.5 **SD:** 19 **IW:** 20.25
Weight: 32 / 32 lbs **Cube:** 15.74

D	E	F	G	H	J	K _{COM}	L	M	N	O	P	Q	R	S	T	U	(# above U) *	S Nail	M Nail
1374	1380	1386	1392	1398	1404	1410	1416	1422	1428	1434	1440	1446	1452	1458	1464	1470	6 (Riser) + 1470 (U)	45	N/A

8819-04

Standard Pillows: N/A **Finish Req:** Y
Standard Cushions: High Resiliency 40 **Standard Finish:** N/A
COM: 2 yards

Kennedy Arm Chair

Width: 24 **Depth:** 25.5 **Height:** 38.25
AH: 25.5 **SH:** 19.5 **SD:** 19 **IW:** 20.25
Weight: 32 / 32 lbs **Cube:** 15.74

D	E	F	G	H	J	K _{COM}	L	M	N	O	P	Q	R	S	T	U	(# above U) *	S Nail	M Nail
1302	1308	1314	1320	1326	1332	1338	1344	1350	1356	1362	1368	1374	1380	1386	1392	1398	6 (Riser) + 1398 (U)	45	N/A

8819-05

Standard Pillows: N/A **Finish Req:** Y
Standard Cushions: High Resiliency 40 **Standard Finish:** N/A
COM: 2 yards

Kennedy Side Chair

Width: 24.5 **Depth:** 25.25 **Height:** 38.25
AH: - **SH:** 19.5 **SD:** 19 **IW:** 24.5
Weight: 30 / 30 lbs **Cube:** 15.74

D	E	F	G	H	J	K _{COM}	L	M	N	O	P	Q	R	S	T	U	(# above U) *	S Nail	M Nail
1215	1221	1227	1233	1239	1245	1251	1257	1263	1269	1275	1281	1287	1293	1299	1305	1311	6 (Riser) + 1311 (U)	45	N/A

8821-04

Standard Pillows: N/A **Finish Req:** Y
Standard Cushions: High Resiliency 40 **Standard Finish:** N/A
COM: 2.25 yards

Clayton Arm Chair

Width: 24.5 **Depth:** 27.25 **Height:** 37.75
AH: 24.5 **SH:** 19.25 **SD:** 20 **IW:** 21
Weight: 22 / 33 lbs **Cube:** 15.74

D	E	F	G	H	J	K _{COM}	L	M	N	O	P	Q	R	S	T	U	(# above U) *	S Nail	M Nail
1452	1458	1464	1470	1476	1482	1488	1494	1500	1506	1512	1518	1524	1530	1536	1542	1548	6 (Riser) + 1548 (U)	45	N/A

8821-05

Standard Pillows: N/A **Finish Req:** Y
Standard Cushions: High Resiliency 40 **Standard Finish:** N/A
COM: 2 yards

Clayton Side Chair

Width: 20 **Depth:** 27 **Height:** 38
AH: - **SH:** 19.5 **SD:** 20.25 **IW:** 20
Weight: 19 / 32 lbs **Cube:** 21.65

D	E	F	G	H	J	K _{COM}	L	M	N	O	P	Q	R	S	T	U	(# above U) *	S Nail	M Nail
1422	1428	1434	1440	1446	1452	1458	1464	1470	1476	1482	1488	1494	1500	1506	1512	1518	6 (Riser) + 1518 (U)	45	N/A

UPHOLSTERY

8822-A2

Standard Pillows: N/A **Finish Req:** Y
Standard Cushions: High Resiliency 40 **Standard Finish:** N/A
COM: 2.75 yards

Macey Arm Chair

Width: 25 **Depth:** 26 **Height:** 36.5
AH: 23.5 **SH:** 19.25 **SD:** 19 **IW:** 20
Weight: 31 / 41 lbs **Cube:** 21.65

D	E	F	G	H	J	K _{COM}	L	M	N	O	P	Q	R	S	T	U	(# above U) *	S Nail	M Nail
1746	1755	1764	1773	1782	1791	1800	1809	1818	1827	1836	1845	1854	1863	1872	1881	1890	9 (Riser) + 1890 (U)	45	N/A

8822-04

Standard Pillows: N/A **Finish Req:** Y
Standard Cushions: High Resiliency 40 **Standard Finish:** N/A
COM: 2.75 yards

Macey Arm Chair

Width: 25 **Depth:** 26 **Height:** 36.5
AH: 23.5 **SH:** 19.25 **SD:** 19 **IW:** 20
Weight: 31 / 41 lbs **Cube:** 21.65

D	E	F	G	H	J	K _{COM}	L	M	N	O	P	Q	R	S	T	U	(# above U) *	S Nail	M Nail
1710	1719	1728	1737	1746	1755	1764	1773	1782	1791	1800	1809	1818	1827	1836	1845	1854	9 (Riser) + 1854 (U)	45	N/A

8833-04

Standard Pillows: N/A **Finish Req:** Y
Standard Cushions: High Resiliency 40 **Standard Finish:** N/A
COM: 2 yards

Mcgee Arm Chair

Width: 25 **Depth:** 25.75 **Height:** 40.25
AH: 25 **SH:** 20 **SD:** 19.75 **IW:** 21.75
Weight: 20 / 31 lbs **Cube:** 17.77

D	E	F	G	H	J	K _{COM}	L	M	N	O	P	Q	R	S	T	U	(# above U) *	S Nail	M Nail
1365	1371	1377	1383	1389	1395	1401	1407	1413	1419	1425	1431	1437	1443	1449	1455	1461	6 (Riser) + 1461 (U)	N/A	N/A

8835-04

Standard Pillows: N/A **Finish Req:** Y
Standard Cushions: High Resiliency 30 **Standard Finish:** N/A
COM: 2.75 yards

Mateo Dining Chair

Width: 27 **Depth:** 22 **Height:** 28.5
AH: 28.5 **SH:** 19 **SD:** 18 **IW:** 17.5
Weight: 23 / 23 lbs **Cube:** 9.79

D	E	F	G	H	J	K _{COM}	L	M	N	O	P	Q	R	S	T	U	(# above U) *	S Nail	M Nail
1395	1404	1413	1422	1431	1440	1449	1458	1467	1476	1485	1494	1503	1512	1521	1530	1539	9 (Riser) + 1539 (U)	N/A	N/A

8836-A4

Standard Pillows: N/A **Finish Req:** Y
Standard Cushions: High Resiliency 40 **Standard Finish:** N/A
COM: 2 yards

Salida Arm Chair

Width: 23 **Depth:** 24.5 **Height:** 36
AH: 25.5 **SH:** 19 **SD:** 19.5 **IW:** 20
Weight: 25 / 35 lbs **Cube:** 15.74

D	E	F	G	H	J	K _{COM}	L	M	N	O	P	Q	R	S	T	U	(# above U) *	S Nail	M Nail
1296	1302	1308	1314	1320	1326	1332	1338	1344	1350	1356	1362	1368	1374	1380	1386	1392	6 (Riser) + 1392 (U)	N/A	N/A

8836-04

Standard Pillows: N/A **Finish Req:** Y
Standard Cushions: High Resiliency 40 **Standard Finish:** N/A
COM: 2 yards

Salida Arm Chair

Width: 23.25 **Depth:** 24 **Height:** 36
AH: 25.75 **SH:** 19.5 **SD:** 20.5 **IW:** 19.75
Weight: 21 / 35 lbs **Cube:** 15.74

D	E	F	G	H	J	K _{COM}	L	M	N	O	P	Q	R	S	T	U	(# above U) *	S Nail	M Nail
1224	1230	1236	1242	1248	1254	1260	1266	1272	1278	1284	1290	1296	1302	1308	1314	1320	6 (Riser) + 1320 (U)	N/A	N/A

8836-05

Standard Pillows: N/A **Finish Req:** Y
Standard Cushions: High Resiliency 40 **Standard Finish:** N/A
COM: 2 yards

Salida Side Chair

Width: 21.75 **Depth:** 25 **Height:** 36
AH: - **SH:** 20 **SD:** 19.5 **IW:** 21.75
Weight: 18 / 28 lbs **Cube:** 15.74

D	E	F	G	H	J	K _{COM}	L	M	N	O	P	Q	R	S	T	U	(# above U) *	S Nail	M Nail
1164	1170	1176	1182	1188	1194	1200	1206	1212	1218	1224	1230	1236	1242	1248	1254	1260	6 (Riser) + 1260 (U)	N/A	N/A

UPHOLSTERY

8837-05

Standard Pillows: N/A **Finish Req:** Y
Standard Cushions: High Resiliency 40 **Standard Finish:** N/A
COM: 2 yards

Longmont Side Chair

Width: 23.25 **Depth:** 24.5 **Height:** 36.5
AH: - **SH:** 19 **SD:** 19 **IW:** 19.25
Weight: 25 / 38 lbs **Cube:** 19.6

D	E	F	G	H	J	K _{COM}	L	M	N	O	P	Q	R	S	T	U	(# above U) *	S Nail	M Nail
1170	1176	1182	1188	1194	1200	1206	1212	1218	1224	1230	1236	1242	1248	1254	1260	1266	6 (Riser) + 1266 (U)	N/A	N/A

8837-11

Standard Pillows: N/A **Finish Req:** Y
Standard Cushions: High Resiliency 40 **Standard Finish:** N/A
COM: 2 yards

Longmont Arm Stack Chair

Width: 23.25 **Depth:** 24.5 **Height:** 36.5
AH: 26.25 **SH:** 19 **SD:** 19 **IW:** 19.25
Weight: 25 / 35 lbs **Cube:** 15.74

D	E	F	G	H	J	K _{COM}	L	M	N	O	P	Q	R	S	T	U	(# above U) *	S Nail	M Nail
1224	1230	1236	1242	1248	1254	1260	1266	1272	1278	1284	1290	1296	1302	1308	1314	1320	6 (Riser) + 1320 (U)	N/A	N/A

8838-A4

Standard Pillows: N/A **Finish Req:** Y
Standard Cushions: High Resiliency 40 **Standard Finish:** N/A
COM: 2 yards

Loveland Arm Chair

Width: 23.25 **Depth:** 24.5 **Height:** 36.5
AH: 26.25 **SH:** 19 **SD:** 19 **IW:** 19.25
Weight: 25 / 25 lbs **Cube:** 12.03

D	E	F	G	H	J	K _{COM}	L	M	N	O	P	Q	R	S	T	U	(# above U) *	S Nail	M Nail
1254	1260	1266	1272	1278	1284	1290	1296	1302	1308	1314	1320	1326	1332	1338	1344	1350	6 (Riser) + 1350 (U)	N/A	N/A

8838-04

Standard Pillows: N/A **Finish Req:** Y
Standard Cushions: High Resiliency 40 **Standard Finish:** N/A
COM: 2 yards

Loveland Arm Chair

Width: 23.25 **Depth:** 24.5 **Height:** 36.5
AH: 26.25 **SH:** 19 **SD:** 19 **IW:** 19.25
Weight: 29 / 39 lbs **Cube:** 15.74

D	E	F	G	H	J	K _{COM}	L	M	N	O	P	Q	R	S	T	U	(# above U) *	S Nail	M Nail
1140	1146	1152	1158	1164	1170	1176	1182	1188	1194	1200	1206	1212	1218	1224	1230	1236	6 (Riser) + 1236 (U)	N/A	N/A

8839-A4

Standard Pillows: N/A **Finish Req:** Y
Standard Cushions: High Resiliency 40 **Standard Finish:** N/A
COM: 2 yards

Littleton Arm Chair

Width: 23.5 **Depth:** 24.5 **Height:** 37
AH: 25.5 **SH:** 19 **SD:** 19.5 **IW:** 20
Weight: 25 / 36 lbs **Cube:** 15.74

D	E	F	G	H	J	K _{COM}	L	M	N	O	P	Q	R	S	T	U	(# above U) *	S Nail	M Nail
1254	1260	1266	1272	1278	1284	1290	1296	1302	1308	1314	1320	1326	1332	1338	1344	1350	6 (Riser) + 1350 (U)	45	N/A

8839-04

Standard Pillows: N/A **Finish Req:** Y
Standard Cushions: High Resiliency 40 **Standard Finish:** N/A
COM: 2 yards

Littleton Arm Chair

Width: 23.25 **Depth:** 24.75 **Height:** 37
AH: 25.75 **SH:** 19 **SD:** 19.5 **IW:** 19.75
Weight: 20 / 35 lbs **Cube:** 15.74

D	E	F	G	H	J	K _{COM}	L	M	N	O	P	Q	R	S	T	U	(# above U) *	S Nail	M Nail
1140	1146	1152	1158	1164	1170	1176	1182	1188	1194	1200	1206	1212	1218	1224	1230	1236	6 (Riser) + 1236 (U)	45	N/A

8839-05

Standard Pillows: N/A **Finish Req:** Y
Standard Cushions: High Resiliency 40 **Standard Finish:** N/A
COM: 2 yards

Littleton Side Chair

Width: 21.75 **Depth:** 25 **Height:** 37
AH: - **SH:** 20 **SD:** 19.5 **IW:** 21.75
Weight: 18 / 28 lbs **Cube:** 15.74

D	E	F	G	H	J	K _{COM}	L	M	N	O	P	Q	R	S	T	U	(# above U) *	S Nail	M Nail
1140	1146	1152	1158	1164	1170	1176	1182	1188	1194	1200	1206	1212	1218	1224	1230	1236	6 (Riser) + 1236 (U)	45	N/A

UPHOLSTERY

8840-04

Lila Arm Chair

Standard Pillows: N/A **Finish Req:** Y
Standard Cushions: High Resiliency 40 **Standard Finish:** N/A
COM: 2 yards

Width: 22.25 **Depth:** 24.5 **Height:** 39
AH: 24.25 **SH:** 19 **SD:** 18.5 **IW:** 18.5
Weight: 19 / 29 lbs **Cube:** 15.74

D	E	F	G	H	J	K _{COM}	L	M	N	O	P	Q	R	S	T	U	(# above U) *	S Nail	M Nail
1350	1356	1362	1368	1374	1380	1386	1392	1398	1404	1410	1416	1422	1428	1434	1440	1446	6 (Riser) + 1446 (U)	45	N/A

8840-05

Lila Side Chair

Standard Pillows: N/A **Finish Req:** Y
Standard Cushions: High Resiliency 40 **Standard Finish:** N/A
COM: 2 yards

Width: 23.25 **Depth:** 24.5 **Height:** 39
AH: - **SH:** 19 **SD:** 18.5 **IW:** 23.75
Weight: 17 / 27 lbs **Cube:** 15.74

D	E	F	G	H	J	K _{COM}	L	M	N	O	P	Q	R	S	T	U	(# above U) *	S Nail	M Nail
1320	1326	1332	1338	1344	1350	1356	1362	1368	1374	1380	1386	1392	1398	1404	1410	1416	6 (Riser) + 1416 (U)	45	N/A

8842-04

Ava Arm Chair

Standard Pillows: N/A **Finish Req:** Y
Standard Cushions: High Resiliency 40 **Standard Finish:** N/A
COM: 2 yards

Width: 22.5 **Depth:** 25.75 **Height:** 40.5
AH: 24.5 **SH:** 19.5 **SD:** 20 **IW:** 20
Weight: 16 / 27 lbs **Cube:** 17.77

Features natural cane accents that was handwoven using the peel of natural rattan. As with any natural product, nature's imperfections and hallmarks will be present in the cane materials. Cane is a handcrafted product dating back to the Ancient Egyptians.

D	E	F	G	H	J	K _{COM}	L	M	N	O	P	Q	R	S	T	U	(# above U) *	S Nail	M Nail
1290	1296	1302	1308	1314	1320	1326	1332	1338	1344	1350	1356	1362	1368	1374	1380	1386	6 (Riser) + 1386 (U)	45	N/A

8842-05

Ava Side Chair

Standard Pillows: N/A **Finish Req:** Y
Standard Cushions: High Resiliency 40 **Standard Finish:** N/A
COM: 2 yards

Width: 22.5 **Depth:** 25.75 **Height:** 40.5
AH: 24.5 **SH:** 19.5 **SD:** 20 **IW:** 20
Weight: 16 / 27 lbs **Cube:** 15.74

Features natural cane accents that was handwoven using the peel of natural rattan. As with any natural product, nature's imperfections and hallmarks will be present in the cane materials. Cane is a handcrafted product dating back to the Ancient Egyptians.

D	E	F	G	H	J	K _{COM}	L	M	N	O	P	Q	R	S	T	U	(# above U) *	S Nail	M Nail
1260	1266	1272	1278	1284	1290	1296	1302	1308	1314	1320	1326	1332	1338	1344	1350	1356	6 (Riser) + 1356 (U)	45	N/A

8845-A4

Turner Arm Chair

Standard Pillows: N/A **Finish Req:** Y
Standard Cushions: High Resiliency 40 **Standard Finish:** N/A
COM: 2.25 yards

Width: 24.75 **Depth:** 29 **Height:** 40
AH: 25 **SH:** 19 **SD:** 19 **IW:** 21.75
Weight: 31 / 45 lbs **Cube:** 21.65

D	E	F	G	H	J	K _{COM}	L	M	N	O	P	Q	R	S	T	U	(# above U) *	S Nail	M Nail
1662	1671	1680	1689	1698	1707	1716	1725	1734	1743	1752	1761	1770	1779	1788	1797	1806	9 (Riser) + 1806 (U)	N/A	N/A

8845-04

Turner Arm Chair

Standard Pillows: N/A **Finish Req:** Y
Standard Cushions: High Resiliency 40 **Standard Finish:** N/A
COM: 2.25 yards

Width: 24.75 **Depth:** 29 **Height:** 40
AH: 25 **SH:** 19 **SD:** 19 **IW:** 21.75
Weight: 31 / 48 lbs **Cube:** 21.65

D	E	F	G	H	J	K _{COM}	L	M	N	O	P	Q	R	S	T	U	(# above U) *	S Nail	M Nail
1590	1599	1608	1617	1626	1635	1644	1653	1662	1671	1680	1689	1698	1707	1716	1725	1734	9 (Riser) + 1734 (U)	N/A	N/A

8846-04

Larson Arm Chair

Standard Pillows: N/A **Finish Req:** Y
Standard Cushions: High Resiliency 40 **Standard Finish:** N/A
COM: 1.5 yards

Width: 21.25 **Depth:** 24.5 **Height:** 34.75
AH: 25.25 **SH:** 20.5 **SD:** 20 **IW:** 19
Weight: 17 / 27 lbs **Cube:** 15.74

Features natural cane accents that was handwoven using the peel of natural rattan. As with any natural product, nature's imperfections and hallmarks will be present in the cane materials. Cane is a handcrafted product dating back to the Ancient Egyptians.

D	E	F	G	H	J	K _{COM}	L	M	N	O	P	Q	R	S	T	U	(# above U) *	S Nail	M Nail
1140	1146	1152	1158	1164	1170	1176	1182	1188	1194	1200	1206	1212	1218	1224	1230	1236	6 (Riser) + 1236 (U)	N/A	N/A

UPHOLSTERY

8846-05

Larson Side Chair

Width: 20 **Depth:** 24.5 **Height:** 34.75
AH: - **SH:** 20.5 **SD:** 20 **IW:** -
Weight: 16 / 26 lbs **Cube:** 15.74

Standard Pillows: N/A **Finish Req:** Y
Standard Cushions: High Resiliency 40 **Standard Finish:** N/A
COM: 1.5 yards
 Features natural cane accents that was handwoven using the peel of natural rattan. As with any natural product, nature's imperfections and hallmarks will be present in the cane materials. Cane is a handcrafted product dating back to the Ancient Egyptians.

D	E	F	G	H	J	K COM	L	M	N	O	P	Q	R	S	T	U	(# above U) *	S Nail	M Nail
1110	1116	1122	1128	1134	1140	1146	1152	1158	1164	1170	1176	1182	1188	1194	1200	1206	6 (Riser) + 1206 (U)	N/A	N/A

8847-A4

Catherine Arm Chair

Width: 23.25 **Depth:** 24.5 **Height:** 37.75
AH: 25.25 **SH:** 19.25 **SD:** 19.25 **IW:** 19.25
Weight: 22 / 32 lbs **Cube:** 15.74

Standard Pillows: N/A **Finish Req:** Y
Standard Cushions: High Resiliency 40 **Standard Finish:** N/A
COM: 2 yards

D	E	F	G	H	J	K COM	L	M	N	O	P	Q	R	S	T	U	(# above U) *	S Nail	M Nail
1392	1398	1404	1410	1416	1422	1428	1434	1440	1446	1452	1458	1464	1470	1476	1482	1488	6 (Riser) + 1488 (U)	75	N/A

8847-04

Catherine Arm Chair

Width: 23.25 **Depth:** 24.5 **Height:** 37.75
AH: 25.25 **SH:** 19.25 **SD:** 19.25 **IW:** 19.25
Weight: 22 / 32 lbs **Cube:** 15.74

Standard Pillows: N/A **Finish Req:** Y
Standard Cushions: High Resiliency 40 **Standard Finish:** N/A
COM: 2 yards

D	E	F	G	H	J	K COM	L	M	N	O	P	Q	R	S	T	U	(# above U) *	S Nail	M Nail
1320	1326	1332	1338	1344	1350	1356	1362	1368	1374	1380	1386	1392	1398	1404	1410	1416	6 (Riser) + 1416 (U)	75	N/A

8849-A2

Rocco Arm Chair

Width: 22 **Depth:** 24.5 **Height:** 35.5
AH: 25 **SH:** 20.25 **SD:** 19 **IW:** 19.75
Weight: 32 / 32 lbs **Cube:** 11.07

Standard Pillows: N/A **Finish Req:** Y
Standard Cushions: High Resiliency 40 **Standard Finish:** N/A
COM: 2 yards
 Standard with 2 front casters and features a hidden handle

D	E	F	G	H	J	K COM	L	M	N	O	P	Q	R	S	T	U	(# above U) *	S Nail	M Nail
1356	1362	1368	1374	1380	1386	1392	1398	1404	1410	1416	1422	1428	1434	1440	1446	1452	6 (Riser) + 1452 (U)	N/A	N/A

8849-A4

Rocco Arm Chair

Width: 22 **Depth:** 24.5 **Height:** 35.5
AH: 25 **SH:** 20.25 **SD:** 19 **IW:** 19.75
Weight: 32 / 32 lbs **Cube:** 11.07

Standard Pillows: N/A **Finish Req:** Y
Standard Cushions: High Resiliency 40 **Standard Finish:** N/A
COM: 2 yards
 Standard with casters on all legs and features a hidden handle

D	E	F	G	H	J	K COM	L	M	N	O	P	Q	R	S	T	U	(# above U) *	S Nail	M Nail
1392	1398	1404	1410	1416	1422	1428	1434	1440	1446	1452	1458	1464	1470	1476	1482	1488	6 (Riser) + 1488 (U)	N/A	N/A

8849-C6

Rocco Counter Stool

Width: 21.25 **Depth:** 24 **Height:** 40.5
AH: 32 **SH:** 26.5 **SD:** 19 **IW:** 21.25
Weight: 25 / 36 lbs **Cube:** 17.77

Standard Pillows: N/A **Finish Req:** Y
Standard Cushions: High Resiliency 40 **Standard Finish:** N/A
COM: 2 yards
 Features a hidden handle

D	E	F	G	H	J	K COM	L	M	N	O	P	Q	R	S	T	U	(# above U) *	S Nail	M Nail
1650	1656	1662	1668	1674	1680	1686	1692	1698	1704	1710	1716	1722	1728	1734	1740	1746	6 (Riser) + 1746 (U)	N/A	N/A

8849-C7

Rocco Counter Stool

Width: 21.25 **Depth:** 24 **Height:** 40.5
AH: - **SH:** 26.5 **SD:** 19 **IW:** 21.25
Weight: 23 / 34 lbs **Cube:** 15.74

Standard Pillows: N/A **Finish Req:** Y
Standard Cushions: High Resiliency 40 **Standard Finish:** N/A
COM: 2 yards
 Features a hidden handle

D	E	F	G	H	J	K COM	L	M	N	O	P	Q	R	S	T	U	(# above U) *	S Nail	M Nail
1590	1596	1602	1608	1614	1620	1626	1632	1638	1644	1650	1656	1662	1668	1674	1680	1686	6 (Riser) + 1686 (U)	N/A	N/A

UPHOLSTERY

8849-04

Rocco Arm Chair

Standard Pillows: N/A **Finish Req:** Y
Standard Cushions: High Resiliency 40 **Standard Finish:** N/A
COM: 2 yards
 Features a hidden handle

Width: 22 **Depth:** 24.5 **Height:** 35.5
AH: 25 **SH:** 20.25 **SD:** 19 **IW:** 19.75
Weight: 32 / 42 lbs **Cube:** 15.74

D	E	F	G	H	J	K _{COM}	L	M	N	O	P	Q	R	S	T	U	(# above U) *	S Nail	M Nail
1320	1326	1332	1338	1344	1350	1356	1362	1368	1374	1380	1386	1392	1398	1404	1410	1416	6 (Riser) + 1416 (U)	N/A	N/A

8849-05

Rocco Dining Chair

Standard Pillows: N/A **Finish Req:** Y
Standard Cushions: High Resiliency 40 **Standard Finish:** N/A
COM: 2 yards
 Features a hidden handle

Width: 20.75 **Depth:** 24.5 **Height:** 35.25
AH: - **SH:** 20 **SD:** 18.75 **IW:** 20.75
Weight: 21 / 21 lbs **Cube:** 10.37

D	E	F	G	H	J	K _{COM}	L	M	N	O	P	Q	R	S	T	U	(# above U) *	S Nail	M Nail
1275	1281	1287	1293	1299	1305	1311	1317	1323	1329	1335	1341	1347	1353	1359	1365	1371	6 (Riser) + 1371 (U)	N/A	N/A

8849-06

Rocco Bar Stool

Standard Pillows: N/A **Finish Req:** Y
Standard Cushions: High Resiliency 40 **Standard Finish:** N/A
COM: 2 yards
 Features a hidden handle

Width: 21.25 **Depth:** 24 **Height:** 44.5
AH: 36 **SH:** 30.5 **SD:** 19 **IW:** 21.25
Weight: 25 / 45 lbs **Cube:** 17.77

D	E	F	G	H	J	K _{COM}	L	M	N	O	P	Q	R	S	T	U	(# above U) *	S Nail	M Nail
1650	1656	1662	1668	1674	1680	1686	1692	1698	1704	1710	1716	1722	1728	1734	1740	1746	6 (Riser) + 1746 (U)	N/A	N/A

8849-07

Rocco Bar Stool

Standard Pillows: N/A **Finish Req:** Y
Standard Cushions: High Resiliency 40 **Standard Finish:** N/A
COM: 2 yards
 Features a hidden handle

Width: 21.25 **Depth:** 24 **Height:** 44.5
AH: - **SH:** 30.5 **SD:** 19 **IW:** 21.25
Weight: 23 / 44 lbs **Cube:** 17.77

D	E	F	G	H	J	K _{COM}	L	M	N	O	P	Q	R	S	T	U	(# above U) *	S Nail	M Nail
1590	1596	1602	1608	1614	1620	1626	1632	1638	1644	1650	1656	1662	1668	1674	1680	1686	6 (Riser) + 1686 (U)	N/A	N/A

8850-A2

Apollo Arm Chair

Standard Pillows: N/A **Finish Req:** Y
Standard Cushions: High Resiliency 40 **Standard Finish:** N/A
COM: 2 yards

Width: 23.25 **Depth:** 25 **Height:** 37.25
AH: 25 **SH:** 20 **SD:** 19 **IW:** 20.25
Weight: 30 / 30 lbs **Cube:** 15.74

D	E	F	G	H	J	K _{COM}	L	M	N	O	P	Q	R	S	T	U	(# above U) *	S Nail	M Nail
1398	1404	1410	1416	1422	1428	1434	1440	1446	1452	1458	1464	1470	1476	1482	1488	1494	6 (Riser) + 1494 (U)	N/A	N/A

8850-A4

Apollo Arm Chair

Standard Pillows: N/A **Finish Req:** Y
Standard Cushions: High Resiliency 40 **Standard Finish:** N/A
COM: 2 yards

Width: 23.25 **Depth:** 25 **Height:** 37.25
AH: 25 **SH:** 20 **SD:** 19 **IW:** 20.25
Weight: 30 / 30 lbs **Cube:** 15.74

D	E	F	G	H	J	K _{COM}	L	M	N	O	P	Q	R	S	T	U	(# above U) *	S Nail	M Nail
1434	1440	1446	1452	1458	1464	1470	1476	1482	1488	1494	1500	1506	1512	1518	1524	1530	6 (Riser) + 1530 (U)	N/A	N/A

8850-04

Apollo Arm Chair

Standard Pillows: N/A **Finish Req:** Y
Standard Cushions: High Resiliency 40 **Standard Finish:** N/A
COM: 2 yards
 Features a notched opening at the top back edge which provides a convenient holding spot.

Width: 23.25 **Depth:** 25 **Height:** 37.25
AH: 25 **SH:** 20 **SD:** 19 **IW:** 20.25
Weight: 30 / 30 lbs **Cube:** 15.74

D	E	F	G	H	J	K _{COM}	L	M	N	O	P	Q	R	S	T	U	(# above U) *	S Nail	M Nail
1362	1368	1374	1380	1386	1392	1398	1404	1410	1416	1422	1428	1434	1440	1446	1452	1458	6 (Riser) + 1458 (U)	N/A	N/A

UPHOLSTERY

8851-A2

Standard Pillows: N/A **Finish Req:** Y
Standard Cushions: High Resiliency 40 **Standard Finish:** N/A
COM: 2 yards

Big Sur Arm Chair

Width: 24 **Depth:** 27 **Height:** 37.5
AH: 25.25 **SH:** 20 **SD:** 21 **IW:** 20.25
Weight: 36 / 33 lbs **Cube:** 15.74

D	E	F	G	H	J	K COM	L	M	N	O	P	Q	R	S	T	U	(# above U) *	S Nail	M Nail
1356	1362	1368	1374	1380	1386	1392	1398	1404	1410	1416	1422	1428	1434	1440	1446	1452	6 (Riser) + 1452 (U)	N/A	N/A

8851-A4

Standard Pillows: N/A **Finish Req:** Y
Standard Cushions: High Resiliency 40 **Standard Finish:** N/A
COM: 2 yards

Big Sur Arm Chair

Width: 24 **Depth:** 27 **Height:** 37.5
AH: 25.25 **SH:** 20 **SD:** 21 **IW:** 20.25
Weight: 36 / 33 lbs **Cube:** 15.74

D	E	F	G	H	J	K COM	L	M	N	O	P	Q	R	S	T	U	(# above U) *	S Nail	M Nail
1392	1398	1404	1410	1416	1422	1428	1434	1440	1446	1452	1458	1464	1470	1476	1482	1488	6 (Riser) + 1488 (U)	N/A	N/A

8851-04

Standard Pillows: N/A **Finish Req:** Y
Standard Cushions: High Resiliency 40 **Standard Finish:** N/A
COM: 2 yards

Big Sur Arm Chair

Width: 24 **Depth:** 27 **Height:** 37.5
AH: 25.25 **SH:** 20 **SD:** 21 **IW:** 20.25
Weight: 36 / 33 lbs **Cube:** 15.74

D	E	F	G	H	J	K COM	L	M	N	O	P	Q	R	S	T	U	(# above U) *	S Nail	M Nail
1320	1326	1332	1338	1344	1350	1356	1362	1368	1374	1380	1386	1392	1398	1404	1410	1416	6 (Riser) + 1416 (U)	N/A	N/A

8852-05

Standard Pillows: N/A **Finish Req:** Y
Standard Cushions: High Resiliency 40 **Standard Finish:** N/A
COM: 3.25 yards

Trenton Side Chair

Width: 22.5 **Depth:** 26.5 **Height:** 41.25
AH: - **SH:** 19.5 **SD:** 18.5 **IW:** 19
Weight: 32 / 43 lbs **Cube:** 15.74

D	E	F	G	H	J	K COM	L	M	N	O	P	Q	R	S	T	U	(# above U) *	S Nail	M Nail
1620	1629	1638	1647	1656	1665	1674	1683	1692	1701	1710	1719	1728	1737	1746	1755	1764	9 (Riser) + 1764 (U)	90	N/A

8852-05-2

Standard Pillows: N/A **Finish Req:** Y
Standard Cushions: High Resiliency 40 **Standard Finish:** N/A
COM: 3.25 yards
 Standard with a Satin Nickel Ring Pull.

Trenton Side Chair

Width: 22.5 **Depth:** 26.5 **Height:** 41.25
AH: - **SH:** 19.5 **SD:** 18.5 **IW:** 19
Weight: 32 / 43 lbs **Cube:** 17.77

D	E	F	G	H	J	K COM	L	M	N	O	P	Q	R	S	T	U	(# above U) *	S Nail	M Nail
1650	1659	1668	1677	1686	1695	1704	1713	1722	1731	1740	1749	1758	1767	1776	1785	1794	9 (Riser) + 1794 (U)	90	N/A

8852-05-6

Standard Pillows: N/A **Finish Req:** Y
Standard Cushions: High Resiliency 40 **Standard Finish:** N/A
COM: 3.25 yards
 Standard with a Brushed Brass Ring Pull.

Trenton Side Chair

Width: 22.5 **Depth:** 26.5 **Height:** 41.25
AH: - **SH:** 19.5 **SD:** 18.5 **IW:** 19
Weight: 32 / 43 lbs **Cube:** 17.77

D	E	F	G	H	J	K COM	L	M	N	O	P	Q	R	S	T	U	(# above U) *	S Nail	M Nail
1650	1659	1668	1677	1686	1695	1704	1713	1722	1731	1740	1749	1758	1767	1776	1785	1794	9 (Riser) + 1794 (U)	90	N/A

8853-A2

Standard Pillows: N/A **Finish Req:** Y
Standard Cushions: High Resiliency 40 **Standard Finish:** N/A
COM: 2 yards
 Standard with 2 front casters and features a notched opening at the top back edge which provides a convenient holding spot.

Reece Arm Chair

Width: 22.5 **Depth:** 25.5 **Height:** 37
AH: 25 **SH:** 20.5 **SD:** 20 **IW:** 19.5
Weight: 22 / 32 lbs **Cube:** 15.74

D	E	F	G	H	J	K COM	L	M	N	O	P	Q	R	S	T	U	(# above U) *	S Nail	M Nail
1386	1395	1404	1413	1422	1431	1440	1449	1458	1467	1476	1485	1494	1503	1512	1521	1530	9 (Riser) + 1530 (U)	N/A	N/A

UPHOLSTERY

8853-A4

Reece Arm Chair

Width: 22.5 Depth: 25.5 Height: 37
 AH: 25 SH: 20.5 SD: 20 IW: 19.5
 Weight: 22 / 32 lbs Cube: 15.74

Standard Pillows: N/A Finish Req: Y
 Standard Cushions: High Resiliency 40 Standard Finish: N/A
 COM: 2 yards
 Standard with casters on all legs and features a notched opening at the top back edge which provides a convenient holding spot.

D	E	F	G	H	J	K COM	L	M	N	O	P	Q	R	S	T	U	(# above U) *	S Nail	M Nail
1422	1431	1440	1449	1458	1467	1476	1485	1494	1503	1512	1521	1530	1539	1548	1557	1566	9 (Riser) + 1566 (U)	N/A	N/A

8853-C6

Reece Counter Stool

Width: 20.5 Depth: 23.25 Height: 44.25
 AH: 32 SH: 27 SD: 16.75 IW: 16.5
 Weight: 21 / 32 lbs Cube: 17.77

Standard Pillows: N/A Finish Req: Y
 Standard Cushions: High Resiliency 40 Standard Finish: N/A
 COM: 2.5 yards
 Features a notched opening at the top back edge which provides a convenient holding spot.

D	E	F	G	H	J	K COM	L	M	N	O	P	Q	R	S	T	U	(# above U) *	S Nail	M Nail
1560	1569	1578	1587	1596	1605	1614	1623	1632	1641	1650	1659	1668	1677	1686	1695	1704	9 (Riser) + 1704 (U)	N/A	N/A

8853-04

Reece Arm Chair

Width: 22.5 Depth: 25.5 Height: 37
 AH: 25 SH: 20.5 SD: 20 IW: 19.5
 Weight: 22 / 32 lbs Cube: 15.74

Standard Pillows: N/A Finish Req: Y
 Standard Cushions: High Resiliency 40 Standard Finish: N/A
 COM: 2 yards
 Features a notched opening at the top back edge which provides a convenient holding spot.

D	E	F	G	H	J	K COM	L	M	N	O	P	Q	R	S	T	U	(# above U) *	S Nail	M Nail
1350	1356	1362	1368	1374	1380	1386	1392	1398	1404	1410	1416	1422	1428	1434	1440	1446	6 (Riser) + 1446 (U)	N/A	N/A

8853-06

Reece Bar Stool

Width: 20.5 Depth: 23.25 Height: 48.25
 AH: 36 SH: 31 SD: 16.75 IW: 16.5
 Weight: 21 / 34 lbs Cube: 19.6

Standard Pillows: N/A Finish Req: Y
 Standard Cushions: High Resiliency 40 Standard Finish: N/A
 COM: 2.5 yards
 Features a notched opening at the top back edge which provides a convenient holding spot.

D	E	F	G	H	J	K COM	L	M	N	O	P	Q	R	S	T	U	(# above U) *	S Nail	M Nail
1560	1569	1578	1587	1596	1605	1614	1623	1632	1641	1650	1659	1668	1677	1686	1695	1704	9 (Riser) + 1704 (U)	N/A	N/A

8854-A2

Cleo Arm Chair

Width: 22.5 Depth: 24.75 Height: 31.75
 AH: 26 SH: 19.5 SD: 19.5 IW: 18
 Weight: 30 / 40 lbs Cube: 21.65

Standard Pillows: N/A Finish Req: Y
 Standard Cushions: High Resiliency 40 Standard Finish: N/A
 COM: 3.75 yards
 Standard with 2 front casters

D	E	F	G	H	J	K COM	L	M	N	O	P	Q	R	S	T	U	(# above U) *	S Nail	M Nail
1821	1833	1845	1857	1869	1881	1893	1905	1917	1929	1941	1953	1965	1977	1989	2001	2013	12 (Riser) + 2013 (U)	75	90

8854-A4

Cleo Arm Chair

Width: 22.5 Depth: 24.75 Height: 31.75
 AH: 26 SH: 19.5 SD: 19.5 IW: 18
 Weight: 30 / 40 lbs Cube: 21.65

Standard Pillows: N/A Finish Req: Y
 Standard Cushions: High Resiliency 40 Standard Finish: N/A
 COM: 3.75 yards
 Standard with casters on all legs

D	E	F	G	H	J	K COM	L	M	N	O	P	Q	R	S	T	U	(# above U) *	S Nail	M Nail
1857	1869	1881	1893	1905	1917	1929	1941	1953	1965	1977	1989	2001	2013	2025	2037	2049	12 (Riser) + 2049 (U)	75	90

8854-C6

Cleo Counter Stool

Width: 22.5 Depth: 24.75 Height: 38.75
 AH: 33 SH: 26.5 SD: 19.5 IW: 18
 Weight: 40 / 50 lbs Cube: 12.48

Standard Pillows: N/A Finish Req: Y
 Standard Cushions: High Resiliency 40 Standard Finish: N/A
 COM: 3.75 yards

D	E	F	G	H	J	K COM	L	M	N	O	P	Q	R	S	T	U	(# above U) *	S Nail	M Nail
1875	1887	1899	1911	1923	1935	1947	1959	1971	1983	1995	2007	2019	2031	2043	2055	2067	12 (Riser) + 2067 (U)	75	90

UPHOLSTERY

8854-04

Cleo Arm Chair

Standard Pillows: N/A **Finish Req:** Y
Standard Cushions: High Resiliency 40 **Standard Finish:** N/A
COM: 3.75 yards

Width: 22.5 **Depth:** 24.75 **Height:** 31.75
AH: 26 **SH:** 19.5 **SD:** 19.5 **IW:** 18
Weight: 30 / 40 lbs **Cube:** 15.74

D	E	F	G	H	J	K _{COM}	L	M	N	O	P	Q	R	S	T	U	(# above U) *	S Nail	M Nail
1785	1797	1809	1821	1833	1845	1857	1869	1881	1893	1905	1917	1929	1941	1953	1965	1977	12 (Riser) + 1977 (U)	75	90

8854-06

Cleo Bar Stool

Standard Pillows: N/A **Finish Req:** Y
Standard Cushions: High Resiliency 40 **Standard Finish:** N/A
COM: 3.75 yards

Width: 22.5 **Depth:** 24.75 **Height:** 42.75
AH: 37 **SH:** 30.5 **SD:** 19.5 **IW:** 18
Weight: 40 / 50 lbs **Cube:** 15.74

D	E	F	G	H	J	K _{COM}	L	M	N	O	P	Q	R	S	T	U	(# above U) *	S Nail	M Nail
1875	1887	1899	1911	1923	1935	1947	1959	1971	1983	1995	2007	2019	2031	2043	2055	2067	12 (Riser) + 2067 (U)	75	90

8854-10

Cleo Bench

Standard Pillows: N/A **Finish Req:** Y
Standard Cushions: High Resiliency 40 **Standard Finish:** N/A
COM: 5 yards

Width: 52.5 **Depth:** 24.75 **Height:** 32
AH: 25.5 **SH:** 20 **SD:** 19.5 **IW:** 47.75
Weight: 52 / 52 lbs **Cube:** 24.06

D	E	F	G	H	J	K _{COM}	L	M	N	O	P	Q	R	S	T	U	(# above U) *	S Nail	M Nail
2475	2490	2505	2520	2535	2550	2565	2580	2595	2610	2625	2640	2655	2670	2685	2700	2715	15 (Riser) + 2715 (U)	120	N/A

8854-40

Cleo Settee

Standard Pillows: N/A **Finish Req:** Y
Standard Cushions: High Resiliency 40 **Standard Finish:** N/A
COM: 5.5 yards

Width: 64.5 **Depth:** 24.75 **Height:** 32
AH: 25.5 **SH:** 20 **SD:** 19.5 **IW:** 59.5
Weight: 58 / 58 lbs **Cube:** 29.56

D	E	F	G	H	J	K _{COM}	L	M	N	O	P	Q	R	S	T	U	(# above U) *	S Nail	M Nail
2685	2703	2721	2739	2757	2775	2793	2811	2829	2847	2865	2883	2901	2919	2937	2955	2973	18 (Riser) + 2973 (U)	135	N/A

8855-A2

Josie Arm Chair

Standard Pillows: N/A **Finish Req:** Y
Standard Cushions: High Resiliency 40 **Standard Finish:** N/A
COM: 3.5 yards
 Standard with 2 front casters

Width: 22.5 **Depth:** 25.5 **Height:** 36.5
AH: 25.75 **SH:** 19.5 **SD:** 19.5 **IW:** 18
Weight: 30 / 44 lbs **Cube:** 12.11

D	E	F	G	H	J	K _{COM}	L	M	N	O	P	Q	R	S	T	U	(# above U) *	S Nail	M Nail
2076	2088	2100	2112	2124	2136	2148	2160	2172	2184	2196	2208	2220	2232	2244	2256	2268	12 (Riser) + 2268 (U)	75	90

8855-A4

Josie Arm Chair

Standard Pillows: N/A **Finish Req:** Y
Standard Cushions: High Resiliency 40 **Standard Finish:** N/A
COM: 3.5 yards
 Standard with casters on all legs

Width: 22.5 **Depth:** 25.5 **Height:** 36.5
AH: 25.75 **SH:** 19.5 **SD:** 19.5 **IW:** 18
Weight: 30 / 44 lbs **Cube:** 12.11

D	E	F	G	H	J	K _{COM}	L	M	N	O	P	Q	R	S	T	U	(# above U) *	S Nail	M Nail
2112	2124	2136	2148	2160	2172	2184	2196	2208	2220	2232	2244	2256	2268	2280	2292	2304	12 (Riser) + 2304 (U)	75	90

8855-C6

Josie Counter Stool

Standard Pillows: N/A **Finish Req:** Y
Standard Cushions: High Resiliency 40 **Standard Finish:** N/A
COM: 3.5 yards

Width: 22.5 **Depth:** 25.5 **Height:** 43.5
AH: 32.75 **SH:** 26.5 **SD:** 19.5 **IW:** 18
Weight: 40 / 53 lbs **Cube:** 19.6

D	E	F	G	H	J	K _{COM}	L	M	N	O	P	Q	R	S	T	U	(# above U) *	S Nail	M Nail
2220	2232	2244	2256	2268	2280	2292	2304	2316	2328	2340	2352	2364	2376	2388	2400	2412	12 (Riser) + 2412 (U)	75	90

UPHOLSTERY

8855-04

Standard Pillows: N/A **Finish Req:** Y
Standard Cushions: High Resiliency 40 **Standard Finish:** N/A
COM: 3.5 yards

Josie Arm Chair

Width: 22.5 **Depth:** 25.5 **Height:** 36.5
AH: 25.75 **SH:** 19.5 **SD:** 19.5 **IW:** 18
Weight: 30 / 44 lbs **Cube:** 21.65

D	E	F	G	H	J	K _{COM}	L	M	N	O	P	Q	R	S	T	U	(# above U) *	S Nail	M Nail
2040	2052	2064	2076	2088	2100	2112	2124	2136	2148	2160	2172	2184	2196	2208	2220	2232	12 (Riser) + 2232 (U)	75	90

8855-06

Standard Pillows: N/A **Finish Req:** Y
Standard Cushions: High Resiliency 40 **Standard Finish:** N/A
COM: 3.5 yards

Josie Bar Stool

Width: 22.5 **Depth:** 25.5 **Height:** 47.5
AH: 36.75 **SH:** 30.5 **SD:** 19.5 **IW:** 18
Weight: 40 / 57 lbs **Cube:** 15.77

D	E	F	G	H	J	K _{COM}	L	M	N	O	P	Q	R	S	T	U	(# above U) *	S Nail	M Nail
2220	2232	2244	2256	2268	2280	2292	2304	2316	2328	2340	2352	2364	2376	2388	2400	2412	12 (Riser) + 2412 (U)	75	90

8855-10

Standard Pillows: N/A **Finish Req:** Y
Standard Cushions: High Resiliency 40 **Standard Finish:** N/A
COM: 5.5 yards

Josie Bench

Width: 52.5 **Depth:** 25.5 **Height:** 36.75
AH: 25.5 **SH:** 20 **SD:** 19.5 **IW:** 47.5
Weight: 56 / 56 lbs **Cube:** 28.47

D	E	F	G	H	J	K _{COM}	L	M	N	O	P	Q	R	S	T	U	(# above U) *	S Nail	M Nail
2475	2490	2505	2520	2535	2550	2565	2580	2595	2610	2625	2640	2655	2670	2685	2700	2715	15 (Riser) + 2715 (U)	150	N/A

8855-40

Standard Pillows: N/A **Finish Req:** Y
Standard Cushions: High Resiliency 40 **Standard Finish:** N/A
COM: 6.25 yards

Josie Settee

Width: 64.5 **Depth:** 25.5 **Height:** 36.75
AH: 25.5 **SH:** 20 **SD:** 19.5 **IW:** 59.5
Weight: 61 / 61 lbs **Cube:** 34.97

D	E	F	G	H	J	K _{COM}	L	M	N	O	P	Q	R	S	T	U	(# above U) *	S Nail	M Nail
2685	2703	2721	2739	2757	2775	2793	2811	2829	2847	2865	2883	2901	2919	2937	2955	2973	18 (Riser) + 2973 (U)	120	N/A

8858-A2

Standard Pillows: N/A **Finish Req:** Y
Standard Cushions: High Resiliency 40 **Standard Finish:** N/A
COM: 2.75 yards
Standard with 2 front casters

Sidda Arm Chair

Two Casters

Width: 22 **Depth:** 25 **Height:** 33.5
AH: 25.25 **SH:** 18.5 **SD:** 18.25 **IW:** 18
Weight: 25 / 35 lbs **Cube:** 15.74

D	E	F	G	H	J	K _{COM}	L	M	N	O	P	Q	R	S	T	U	(# above U) *	S Nail	M Nail
1236	1245	1254	1263	1272	1281	1290	1299	1308	1317	1326	1335	1344	1353	1362	1371	1380	9 (Riser) + 1380 (U)	45	60

8858-A4

Standard Pillows: N/A **Finish Req:** Y
Standard Cushions: High Resiliency 40 **Standard Finish:** N/A
COM: 2.75 yards
Standard with 4 casters

Sidda Arm Chair

Four Casters

Width: 22 **Depth:** 25 **Height:** 33.5
AH: 25.25 **SH:** 18.5 **SD:** 18.25 **IW:** 18
Weight: 25 / 25 lbs **Cube:** 10.66

D	E	F	G	H	J	K _{COM}	L	M	N	O	P	Q	R	S	T	U	(# above U) *	S Nail	M Nail
1272	1281	1290	1299	1308	1317	1326	1335	1344	1353	1362	1371	1380	1389	1398	1407	1416	9 (Riser) + 1416 (U)	45	60

8858-04

Standard Pillows: N/A **Finish Req:** Y
Standard Cushions: High Resiliency 40 **Standard Finish:** N/A
COM: 2.75 yards

Sidda Arm Chair

Width: 22 **Depth:** 25 **Height:** 33.5
AH: 25.25 **SH:** 18.5 **SD:** 18.25 **IW:** 18
Weight: 25 / 25 lbs **Cube:** 10.66

D	E	F	G	H	J	K _{COM}	L	M	N	O	P	Q	R	S	T	U	(# above U) *	S Nail	M Nail
1200	1209	1218	1227	1236	1245	1254	1263	1272	1281	1290	1299	1308	1317	1326	1335	1344	9 (Riser) + 1344 (U)	45	60

UPHOLSTERY

8859-A4

Standard Pillows: N/A **Finish Req:** Y
Standard Cushions: High Resiliency 40 **Standard Finish:** N/A
COM: 2 yards

Bentley Arm Chair

Width: 23.5 **Depth:** 27.5 **Height:** 38.25
AH: 25 **SH:** 19.5 **SD:** 20 **IW:** 20
Weight: 25 / 35 lbs **Cube:** 14.3

D	E	F	G	H	J	K _{COM}	L	M	N	O	P	Q	R	S	T	U	(# above U) *	S Nail	M Nail
1362	1368	1374	1380	1386	1392	1398	1404	1410	1416	1422	1428	1434	1440	1446	1452	1458	6 (Riser) + 1458 (U)	N/A	N/A

8859-04

Standard Pillows: N/A **Finish Req:** Y
Standard Cushions: High Resiliency 40 **Standard Finish:** N/A
COM: 2 yards

Bentley Arm Chair

Width: 23.5 **Depth:** 27.5 **Height:** 38.25
AH: 25 **SH:** 19.5 **SD:** 20 **IW:** 20
Weight: 25 / 35 lbs **Cube:** 15.74

D	E	F	G	H	J	K _{COM}	L	M	N	O	P	Q	R	S	T	U	(# above U) *	S Nail	M Nail
1290	1296	1302	1308	1314	1320	1326	1332	1338	1344	1350	1356	1362	1368	1374	1380	1386	6 (Riser) + 1386 (U)	N/A	N/A

8859-05

Standard Pillows: N/A **Finish Req:** Y
Standard Cushions: High Resiliency 40 **Standard Finish:** N/A
COM: 2 yards

Bentley Side Chair

Width: 20 **Depth:** 27.5 **Height:** 38.25
AH: - **SH:** 19.5 **SD:** 20 **IW:** 20
Weight: 21 / 31 lbs **Cube:** 15.74

D	E	F	G	H	J	K _{COM}	L	M	N	O	P	Q	R	S	T	U	(# above U) *	S Nail	M Nail
1260	1266	1272	1278	1284	1290	1296	1302	1308	1314	1320	1326	1332	1338	1344	1350	1356	6 (Riser) + 1356 (U)	N/A	N/A

8860-A2

Standard Pillows: N/A **Finish Req:** Y
Standard Cushions: High Resiliency 40 **Standard Finish:** N/A
COM: 2.5 yards
 Standard with 2 front casters

Sasha Arm Chair

Two Casters

Width: 23 **Depth:** 27.5 **Height:** 39.5
AH: 25 **SH:** 19 **SD:** 20 **IW:** 20
Weight: 25 / 25 lbs **Cube:** 14.45

D	E	F	G	H	J	K _{COM}	L	M	N	O	P	Q	R	S	T	U	(# above U) *	S Nail	M Nail
1206	1215	1224	1233	1242	1251	1260	1269	1278	1287	1296	1305	1314	1323	1332	1341	1350	9 (Riser) + 1350 (U)	45	N/A

8860-A4

Standard Pillows: N/A **Finish Req:** Y
Standard Cushions: High Resiliency 40 **Standard Finish:** N/A
COM: 2.5 yards
 Standard with 4 casters

Sasha Arm Chair

Four Casters

Width: 23 **Depth:** 27.5 **Height:** 39.5
AH: 25 **SH:** 19 **SD:** 20 **IW:** 20
Weight: 25 / 25 lbs **Cube:** 14.45

D	E	F	G	H	J	K _{COM}	L	M	N	O	P	Q	R	S	T	U	(# above U) *	S Nail	M Nail
1242	1251	1260	1269	1278	1287	1296	1305	1314	1323	1332	1341	1350	1359	1368	1377	1386	9 (Riser) + 1386 (U)	45	N/A

8860-04

Standard Pillows: N/A **Finish Req:** Y
Standard Cushions: High Resiliency 40 **Standard Finish:** N/A
COM: 2.5 yards

Sasha Arm Chair

Width: 23 **Depth:** 27.5 **Height:** 39.5
AH: 25 **SH:** 19 **SD:** 20 **IW:** 20
Weight: 25 / 25 lbs **Cube:** 14.45

D	E	F	G	H	J	K _{COM}	L	M	N	O	P	Q	R	S	T	U	(# above U) *	S Nail	M Nail
1170	1179	1188	1197	1206	1215	1224	1233	1242	1251	1260	1269	1278	1287	1296	1305	1314	9 (Riser) + 1314 (U)	45	N/A

8860-05

Standard Pillows: N/A **Finish Req:** Y
Standard Cushions: High Resiliency 40 **Standard Finish:** N/A
COM: 2.5 yards

Sasha Side Chair

Width: 21.5 **Depth:** 27.5 **Height:** 39
AH: - **SH:** 19 **SD:** 20 **IW:** 21.5
Weight: 24 / 24 lbs **Cube:** 15.74

D	E	F	G	H	J	K _{COM}	L	M	N	O	P	Q	R	S	T	U	(# above U) *	S Nail	M Nail
1140	1149	1158	1167	1176	1185	1194	1203	1212	1221	1230	1239	1248	1257	1266	1275	1284	9 (Riser) + 1284 (U)	45	N/A

UPHOLSTERY

8862-A2

Portia Arm Chair

Two Casters

Width: 24.5 Depth: 25 Height: 38

AH: 26 SH: 19 SD: 18.5 IW: 21

Weight: 25 / 25 lbs Cube: 13.46

Standard Pillows: N/A Finish Req: Y

Standard Cushions: High Resiliency 40 Standard Finish: N/A

COM: 2 yards

Standard with 2 front casters

D	E	F	G	H	J	K _{COM}	L	M	N	O	P	Q	R	S	T	U	(# above U) *	S Nail	M Nail
1161	1167	1173	1179	1185	1191	1197	1203	1209	1215	1221	1227	1233	1239	1245	1251	1257	6 (Riser) + 1257 (U)	45	N/A

8862-A4

Portia Arm Chair

Four Casters

Width: 24.5 Depth: 25 Height: 38

AH: 26 SH: 19 SD: 18.5 IW: 21

Weight: 25 / 25 lbs Cube: 13.46

Standard Pillows: N/A Finish Req: Y

Standard Cushions: High Resiliency 40 Standard Finish: N/A

COM: 2 yards

Standard with 4 casters

D	E	F	G	H	J	K _{COM}	L	M	N	O	P	Q	R	S	T	U	(# above U) *	S Nail	M Nail
1197	1203	1209	1215	1221	1227	1233	1239	1245	1251	1257	1263	1269	1275	1281	1287	1293	6 (Riser) + 1293 (U)	45	N/A

8862-04

Portia Arm Chair

Width: 24.5 Depth: 25 Height: 38

AH: 26 SH: 19 SD: 18.5 IW: 21

Weight: 25 / 25 lbs Cube: 13.46

Standard Pillows: N/A Finish Req: Y

Standard Cushions: High Resiliency 40 Standard Finish: N/A

COM: 2 yards

D	E	F	G	H	J	K _{COM}	L	M	N	O	P	Q	R	S	T	U	(# above U) *	S Nail	M Nail
1125	1131	1137	1143	1149	1155	1161	1167	1173	1179	1185	1191	1197	1203	1209	1215	1221	6 (Riser) + 1221 (U)	45	N/A

8863-A2

Toulouse Arm Chair

Two Casters

Width: 23.5 Depth: 26 Height: 37

AH: 25 SH: 19.5 SD: 20 IW: 21

Weight: 23 / 23 lbs Cube: 13.08

Standard Pillows: N/A Finish Req: Y

Standard Cushions: High Resiliency 40 Standard Finish: N/A

COM: 2 yards

Standard with two front casters.

D	E	F	G	H	J	K _{COM}	L	M	N	O	P	Q	R	S	T	U	(# above U) *	S Nail	M Nail
1281	1287	1293	1299	1305	1311	1317	1323	1329	1335	1341	1347	1353	1359	1365	1371	1377	6 (Riser) + 1377 (U)	N/A	N/A

8863-A4

Toulouse Arm Chair

Four Casters

Width: 23.5 Depth: 26 Height: 37

AH: 25 SH: 19.5 SD: 20 IW: 21

Weight: 23 / 23 lbs Cube: 13.08

Standard Pillows: N/A Finish Req: Y

Standard Cushions: High Resiliency 40 Standard Finish: N/A

COM: 2 yards

Standard with four casters.

D	E	F	G	H	J	K _{COM}	L	M	N	O	P	Q	R	S	T	U	(# above U) *	S Nail	M Nail
1317	1323	1329	1335	1341	1347	1353	1359	1365	1371	1377	1383	1389	1395	1401	1407	1413	6 (Riser) + 1413 (U)	N/A	N/A

8863-04

Toulouse Arm Chair

Width: 23.5 Depth: 26 Height: 37

AH: 25 SH: 19.5 SD: 20 IW: 21

Weight: 23 / 23 lbs Cube: 15.74

Standard Pillows: N/A Finish Req: Y

Standard Cushions: High Resiliency 40 Standard Finish: N/A

COM: 2 yards

D	E	F	G	H	J	K _{COM}	L	M	N	O	P	Q	R	S	T	U	(# above U) *	S Nail	M Nail
1245	1251	1257	1263	1269	1275	1281	1287	1293	1299	1305	1311	1317	1323	1329	1335	1341	6 (Riser) + 1341 (U)	N/A	N/A

8868-A2

Sidda Arm Chair

Two Casters

Width: 22 Depth: 25 Height: 33.5

AH: 25 SH: 18.5 SD: 18 IW: 18

Weight: 25 / 25 lbs Cube: 10.66

Standard Pillows: N/A Finish Req: Y

Standard Cushions: High Resiliency 40 Standard Finish: N/A

COM: 2.75 yards

Standard with 2 front casters

D	E	F	G	H	J	K _{COM}	L	M	N	O	P	Q	R	S	T	U	(# above U) *	S Nail	M Nail
1161	1170	1179	1188	1197	1206	1215	1224	1233	1242	1251	1260	1269	1278	1287	1296	1305	9 (Riser) + 1305 (U)	45	60

UPHOLSTERY

8868-A4

Sidda Arm Chair
Four Casters

Width: 22 **Depth:** 25 **Height:** 33.5
AH: 25 **SH:** 18.5 **SD:** 18 **IW:** 18
Weight: 25 / 25 lbs **Cube:** 10.66

Standard Pillows: N/A **Finish Req:** Y
Standard Cushions: High Resiliency 40 **Standard Finish:** N/A
COM: 2.75 yards
Standard with 4 casters

D	E	F	G	H	J	K _{COM}	L	M	N	O	P	Q	R	S	T	U	(# above U) *	S Nail	M Nail
1197	1206	1215	1224	1233	1242	1251	1260	1269	1278	1287	1296	1305	1314	1323	1332	1341	9 (Riser) + 1341 (U)	45	60

8868-04

Sidda Arm Chair

Width: 22 **Depth:** 25 **Height:** 33.5
AH: 25 **SH:** 18.5 **SD:** 18 **IW:** 18
Weight: 25 / 25 lbs **Cube:** 10.66

Standard Pillows: N/A **Finish Req:** Y
Standard Cushions: High Resiliency 40 **Standard Finish:** N/A
COM: 2.75 yards

D	E	F	G	H	J	K _{COM}	L	M	N	O	P	Q	R	S	T	U	(# above U) *	S Nail	M Nail
1125	1134	1143	1152	1161	1170	1179	1188	1197	1206	1215	1224	1233	1242	1251	1260	1269	9 (Riser) + 1269 (U)	45	60

8869-04

Casey Arm Chair

Width: 25 **Depth:** 25.5 **Height:** 38
AH: 26 **SH:** 20 **SD:** 17.5 **IW:** 22
Weight: 30 / 40 lbs **Cube:** 15.74

Standard Pillows: N/A **Finish Req:** Y
Standard Cushions: High Resiliency 40 **Standard Finish:** N/A
COM: 3.5 yards

D	E	F	G	H	J	K _{COM}	L	M	N	O	P	Q	R	S	T	U	(# above U) *	S Nail	M Nail
1275	1284	1293	1302	1311	1320	1329	1338	1347	1356	1365	1374	1383	1392	1401	1410	1419	9 (Riser) + 1419 (U)	45	60

8869-05

Casey Side Chair

Width: 22.5 **Depth:** 25.5 **Height:** 38
AH: - **SH:** 20 **SD:** 17.5 **IW:** -
Weight: 25 / 35 lbs **Cube:** 15.74

Standard Pillows: N/A **Finish Req:** Y
Standard Cushions: High Resiliency 40 **Standard Finish:** N/A
COM: 3.5 yards

D	E	F	G	H	J	K _{COM}	L	M	N	O	P	Q	R	S	T	U	(# above U) *	S Nail	M Nail
1230	1239	1248	1257	1266	1275	1284	1293	1302	1311	1320	1329	1338	1347	1356	1365	1374	9 (Riser) + 1374 (U)	45	60

8899-A4

Coleman Arm Chair

Width: 24.5 **Depth:** 29.5 **Height:** 38.5
AH: 24.25 **SH:** 19.5 **SD:** 18 **IW:** 19
Weight: 34 / 44 lbs **Cube:** 21.65

Standard Pillows: (1) 10 x 16 Kidney **Finish Req:** N
Standard Cushions: Endurance **Standard Finish:** traditional
COM: 5.5 yards

D	E	F	G	H	J	K _{COM}	L	M	N	O	P	Q	R	S	T	U	(# above U) *	S Nail	M Nail
2025	2043	2061	2079	2097	2115	2133	2151	2169	2187	2205	2223	2241	2259	2277	2295	2313	18 (Riser) + 2313 (U)	N/A	N/A

C-1138-01-7

Tipsy Lounge Chair
Bright Brass Base

Width: 0 **Depth:** 0 **Height:** 0
AH: - **SH:** - **SD:** - **IW:** -
Weight: 0 / 0 lbs **Cube:** 0

Standard Pillows: N/A **Finish Req:** N
Standard Cushions: Endurance **Standard Finish:** Bright Brass
COM: 4.75 yards
Only available in Bright Brass

D	E	F	G	H	J	K _{COM}	L	M	N	O	P	Q	R	S	T	U	(# above U) *	S Nail	M Nail
2445	2460	2475	2490	2505	2520	2535	2550	2565	2580	2595	2610	2625	2640	2655	2670	2685	15 (Riser) + 2685 (U)	60	75

C-1138-31

Tipsy Swivel Chair

Width: 28.75 **Depth:** 31 **Height:** 30.25
AH: 25 **SH:** 19 **SD:** 22.5 **IW:** 22
Weight: 59 / 72 lbs **Cube:** 23.89

Standard Pillows: N/A **Finish Req:** Y
Standard Cushions: Endurance **Standard Finish:** N/A
COM: 4.75 yards

D	E	F	G	H	J	K _{COM}	L	M	N	O	P	Q	R	S	T	U	(# above U) *	S Nail	M Nail
2220	2235	2250	2265	2280	2295	2310	2325	2340	2355	2370	2385	2400	2415	2430	2445	2460	15 (Riser) + 2460 (U)	60	75

UPHOLSTERY

C-1138-31-2

Standard Pillows: N/A **Finish Req:** N
Standard Cushions: Endurance **Standard Finish:** Nickel
COM: 4.75 yards

Tipsy Swivel Chair

Width: 28.75 **Depth:** 31 **Height:** 30.25
AH: 25 **SH:** 19 **SD:** 22.5 **IW:** 22
Weight: 59 / 68 lbs **Cube:** 23.89

D	E	F	G	H	J	K _{COM}	L	M	N	O	P	Q	R	S	T	U	(# above U) *	S Nail	M Nail
2520	2535	2550	2565	2580	2595	2610	2625	2640	2655	2670	2685	2700	2715	2730	2745	2760	15 (Riser) + 2760 (U)	60	75

C-1138-31-7

Standard Pillows: N/A **Finish Req:** N
Standard Cushions: Endurance **Standard Finish:** Bright Brass
COM: 4.75 yards

Tipsy Swivel Chair

Width: 28.75 **Depth:** 31 **Height:** 30.25
AH: 25 **SH:** 19 **SD:** 22.5 **IW:** 22
Weight: 59 / 72 lbs **Cube:** 23.89

D	E	F	G	H	J	K _{COM}	L	M	N	O	P	Q	R	S	T	U	(# above U) *	S Nail	M Nail
2520	2535	2550	2565	2580	2595	2610	2625	2640	2655	2670	2685	2700	2715	2730	2745	2760	15 (Riser) + 2760 (U)	60	75

C-1139-31

Standard Pillows: N/A **Finish Req:** Y
Standard Cushions: Endurance **Standard Finish:** N/A
COM: 4.75 yards

Tipsy Swivel Chair

Width: 28.75 **Depth:** 31 **Height:** 30.25
AH: 25.5 **SH:** 19 **SD:** 22 **IW:** 21.25
Weight: 59 / 72 lbs **Cube:** 23.89

D	E	F	G	H	J	K _{COM}	L	M	N	O	P	Q	R	S	T	U	(# above U) *	S Nail	M Nail
2475	2490	2505	2520	2535	2550	2565	2580	2595	2610	2625	2640	2655	2670	2685	2700	2715	15 (Riser) + 2715 (U)	60	75

C-1139-31-2

Standard Pillows: N/A **Finish Req:** N
Standard Cushions: Endurance **Standard Finish:** Nickel
COM: 4.75 yards

Tipsy Swivel Chair

Width: 28.75 **Depth:** 31 **Height:** 30.25
AH: 25.5 **SH:** 19 **SD:** 22 **IW:** 21.25
Weight: 59 / 59 lbs **Cube:** 15.6

D	E	F	G	H	J	K _{COM}	L	M	N	O	P	Q	R	S	T	U	(# above U) *	S Nail	M Nail
2745	2760	2775	2790	2805	2820	2835	2850	2865	2880	2895	2910	2925	2940	2955	2970	2985	15 (Riser) + 2985 (U)	60	75

C-1139-31-7

Standard Pillows: N/A **Finish Req:** N
Standard Cushions: Endurance **Standard Finish:** Bright Brass
COM: 4.75 yards

Tipsy Swivel Chair

Width: 28.75 **Depth:** 31 **Height:** 30.25
AH: 25.5 **SH:** 19 **SD:** 22 **IW:** 21.25
Weight: 59 / 72 lbs **Cube:** 23.89

D	E	F	G	H	J	K _{COM}	L	M	N	O	P	Q	R	S	T	U	(# above U) *	S Nail	M Nail
2745	2760	2775	2790	2805	2820	2835	2850	2865	2880	2895	2910	2925	2940	2955	2970	2985	15 (Riser) + 2985 (U)	60	75

C-1181-01

Standard Pillows: N/A **Finish Req:** Y
Standard Cushions: Endurance **Standard Finish:** N/A
COM: 7 yards

Mason Lounge Chair

Width: 30 **Depth:** 37 **Height:** 34.5
AH: 25.5 **SH:** 18.5 **SD:** 23 **IW:** 23
Weight: 73 / 87 lbs **Cube:** 29.69

D	E	F	G	H	J	K _{COM}	L	M	N	O	P	Q	R	S	T	U	(# above U) *	S Nail	M Nail
2430	2451	2472	2493	2514	2535	2556	2577	2598	2619	2640	2661	2682	2703	2724	2745	2766	21 (Riser) + 2766 (U)	75	90

C-1181-31

Standard Pillows: N/A **Finish Req:** Y
Standard Cushions: Endurance **Standard Finish:** N/A
COM: 7 yards

Mason Swivel Chair

Width: 30 **Depth:** 37 **Height:** 34.5
AH: 25.5 **SH:** 18.5 **SD:** 23 **IW:** 23
Weight: 73 / 87 lbs **Cube:** 29.69

D	E	F	G	H	J	K _{COM}	L	M	N	O	P	Q	R	S	T	U	(# above U) *	S Nail	M Nail
2430	2451	2472	2493	2514	2535	2556	2577	2598	2619	2640	2661	2682	2703	2724	2745	2766	21 (Riser) + 2766 (U)	75	90

UPHOLSTERY

C-1405-01

Standard Pillows: N/A **Finish Req:** Y
Standard Cushions: Endurance **Standard Finish:** N/A
COM: 5.5 yards

Starke Occasional Chair

Width: 30.5 **Depth:** 36 **Height:** 43.5
AH: 26 **SH:** 19 **SD:** 21.5 **IW:** 21
Weight: 65 / 71 lbs **Cube:** 34.38

D	E	F	G	H	J	K _{COM}	L	M	N	O	P	Q	R	S	T	U	(# above U) *	S Nail	M Nail
2415	2433	2451	2469	2487	2505	2523	2541	2559	2577	2595	2613	2631	2649	2667	2685	2703	18 (Riser) + 2703 (U)	90	N/A

C-1417-01

Standard Pillows: N/A **Finish Req:** Y
Standard Cushions: Endurance **Standard Finish:** N/A
COM: 6.5 yards

Jean-Michel Lounge Chair

Width: 30.5 **Depth:** 36 **Height:** 34
AH: 24 **SH:** 20 **SD:** 20.5 **IW:** 23
Weight: 60 / 74 lbs **Cube:** 29.69

D	E	F	G	H	J	K _{COM}	L	M	N	O	P	Q	R	S	T	U	(# above U) *	S Nail	M Nail
2595	2613	2631	2649	2667	2685	2703	2721	2739	2757	2775	2793	2811	2829	2847	2865	2883	18 (Riser) + 2883 (U)	75	N/A

C-1417-50

Standard Pillows: N/A **Finish Req:** Y
Standard Cushions: Endurance **Standard Finish:** N/A
COM: 15.5 yards

Jean-Michel Sofa

Width: 76 **Depth:** 36 **Height:** 34
AH: 24 **SH:** 20 **SD:** 20.5 **IW:** 69
Weight: 113 / 147 lbs **Cube:** 68.15

D	E	F	G	H	J	K _{COM}	L	M	N	O	P	Q	R	S	T	U	(# above U) *	S Nail	M Nail
4455	4500	4545	4590	4635	4680	4725	4770	4815	4860	4905	4950	4995	5040	5085	5130	5175	45 (Riser) + 5175 (U)	105	N/A

C-1424-01

Standard Pillows: N/A **Finish Req:** Y
Standard Cushions: Endurance **Standard Finish:** N/A
COM: 7.5 yards

Presley Lounge Chair

Width: 35 **Depth:** 39 **Height:** 39.5
AH: 24 **SH:** 19 **SD:** 20.5 **IW:** 19.5
Weight: 80 / 80 lbs **Cube:** 31.2

D	E	F	G	H	J	K _{COM}	L	M	N	O	P	Q	R	S	T	U	(# above U) *	S Nail	M Nail
2730	2751	2772	2793	2814	2835	2856	2877	2898	2919	2940	2961	2982	3003	3024	3045	3066	21 (Riser) + 3066 (U)	45	60

C-1424-20

Standard Pillows: N/A **Finish Req:** Y
Standard Cushions: High Resiliency 30 **Standard Finish:** N/A
COM: 2.75 yards

Presley Ottoman

Width: 26.25 **Depth:** 21 **Height:** 16.5
AH: - **SH:** - **SD:** - **IW:** -
Weight: 26 / 26 lbs **Cube:** 5.26

D	E	F	G	H	J	K _{COM}	L	M	N	O	P	Q	R	S	T	U	(# above U) *	S Nail	M Nail
1155	1164	1173	1182	1191	1200	1209	1218	1227	1236	1245	1254	1263	1272	1281	1290	1299	9 (Riser) + 1299 (U)	30	45

C-1424-59

Standard Pillows: N/A **Finish Req:** Y
Standard Cushions: Endurance **Standard Finish:** N/A
COM: 8.75 yards

Presley Tilt-Back Chair

Width: 35 **Depth:** 39 **Height:** 39.5
AH: 24 **SH:** 19 **SD:** 20.5 **IW:** 25
Weight: 96 / 96 lbs **Cube:** 31.2

D	E	F	G	H	J	K _{COM}	L	M	N	O	P	Q	R	S	T	U	(# above U) *	S Nail	M Nail
3270	3294	3318	3342	3366	3390	3414	3438	3462	3486	3510	3534	3558	3582	3606	3630	3654	24 (Riser) + 3654 (U)	45	60

C-1434-MS-2

Standard Pillows: N/A **Finish Req:** N
Standard Cushions: Endurance **Standard Finish:** Nickel
COM: 6 yards
 Standard with Nickel metal finish

Kyle Memory Swivel Chair

Width: 28.5 **Depth:** 35 **Height:** 31.5
AH: 25.5 **SH:** 20 **SD:** 23 **IW:** 22
Weight: 65 / 72 lbs **Cube:** 29.69

D	E	F	G	H	J	K _{COM}	L	M	N	O	P	Q	R	S	T	U	(# above U) *	S Nail	M Nail
2775	2793	2811	2829	2847	2865	2883	2901	2919	2937	2955	2973	2991	3009	3027	3045	3063	18 (Riser) + 3063 (U)	75	90

UPHOLSTERY

C-1434-MS-6

Kyle Memory Swivel Chair

Standard Pillows: N/A **Finish Req:** N

Standard Cushions: Endurance **Standard Finish:** BRUSHED BRASS

COM: 6 yards

Standard with a Brushed Brass metal finish

Width: 28.5 **Depth:** 35 **Height:** 31.5

AH: 25.5 **SH:** 20 **SD:** 23 **IW:** 22

Weight: 65 / 65 lbs **Cube:** 18.18

D	E	F	G	H	J	K _{COM}	L	M	N	O	P	Q	R	S	T	U	(# above U) *	S Nail	M Nail
2775	2793	2811	2829	2847	2865	2883	2901	2919	2937	2955	2973	2991	3009	3027	3045	3063	18 (Riser) + 3063 (U)	75	90

C-1434-01

Kyle Lounge Chair

Standard Pillows: N/A **Finish Req:** Y

Standard Cushions: Endurance **Standard Finish:** N/A

COM: 6 yards

Width: 28.5 **Depth:** 35 **Height:** 31.5

AH: 25.5 **SH:** 20 **SD:** 23 **IW:** 22

Weight: 65 / 79 lbs **Cube:** 29.69

D	E	F	G	H	J	K _{COM}	L	M	N	O	P	Q	R	S	T	U	(# above U) *	S Nail	M Nail
2340	2358	2376	2394	2412	2430	2448	2466	2484	2502	2520	2538	2556	2574	2592	2610	2628	18 (Riser) + 2628 (U)	75	90

C-1434-20

Kyle Ottoman

Standard Pillows: N/A **Finish Req:** Y

Standard Cushions: High Resiliency 30 **Standard Finish:** N/A

COM: 2.25 yards

Width: 26.5 **Depth:** 21 **Height:** 17.5

AH: - **SH:** - **SD:** - **IW:** -

Weight: 21 / 28 lbs **Cube:** 7.74

D	E	F	G	H	J	K _{COM}	L	M	N	O	P	Q	R	S	T	U	(# above U) *	S Nail	M Nail
960	966	972	978	984	990	996	1002	1008	1014	1020	1026	1032	1038	1044	1050	1056	6 (Riser) + 1056 (U)	30	45

C-1439-01

Vivian Occasional Chair

Standard Pillows: N/A **Finish Req:** Y

Standard Cushions: Endurance **Standard Finish:** N/A

COM: 6.75 yards

Width: 30 **Depth:** 36.25 **Height:** 33

AH: 24 **SH:** 19.75 **SD:** 20 **IW:** 26.25

Weight: 54 / 68 lbs **Cube:** 29.69

D	E	F	G	H	J	K _{COM}	L	M	N	O	P	Q	R	S	T	U	(# above U) *	S Nail	M Nail
2940	2958	2976	2994	3012	3030	3048	3066	3084	3102	3120	3138	3156	3174	3192	3210	3228	18 (Riser) + 3228 (U)	75	N/A

C-1444-01

Edgeworth Wing Chair

Standard Pillows: N/A **Finish Req:** Y

Standard Cushions: Endurance **Standard Finish:** N/A

COM: 5.5 yards

Width: 32 **Depth:** 40 **Height:** 42.5

AH: 25 **SH:** 20.5 **SD:** 19 **IW:** 20.5

Weight: 65 / 65 lbs **Cube:** 31.48

D	E	F	G	H	J	K _{COM}	L	M	N	O	P	Q	R	S	T	U	(# above U) *	S Nail	M Nail
2820	2835	2850	2865	2880	2895	2910	2925	2940	2955	2970	2985	3000	3015	3030	3045	3060	15 (Riser) + 3060 (U)	N/A	N/A

C-1444-20

Edgeworth Ottoman

Standard Pillows: N/A **Finish Req:** Y

Standard Cushions: High Resiliency 30 **Standard Finish:** N/A

COM: 2.25 yards

Width: 23.5 **Depth:** 19.25 **Height:** 18

AH: - **SH:** - **SD:** - **IW:** -

Weight: 18 / 18 lbs **Cube:** 4.71

D	E	F	G	H	J	K _{COM}	L	M	N	O	P	Q	R	S	T	U	(# above U) *	S Nail	M Nail
1185	1194	1203	1212	1221	1230	1239	1248	1257	1266	1275	1284	1293	1302	1311	1320	1329	9 (Riser) + 1329 (U)	N/A	N/A

C-1448-01

Grover Lounge Chair

Standard Pillows: N/A **Finish Req:** Y

Standard Cushions: Endurance **Standard Finish:** N/A

COM: 6.5 yards

Width: 30 **Depth:** 36.5 **Height:** 36.5

AH: 24.5 **SH:** 20 **SD:** 24 **IW:** 20

Weight: 60 / 77 lbs **Cube:** 36.49

D	E	F	G	H	J	K _{COM}	L	M	N	O	P	Q	R	S	T	U	(# above U) *	S Nail	M Nail
2445	2463	2481	2499	2517	2535	2553	2571	2589	2607	2625	2643	2661	2679	2697	2715	2733	18 (Riser) + 2733 (U)	120	135

UPHOLSTERY

C-1448-31

Standard Pillows: N/A **Finish Req:** N
Standard Cushions: Endurance **Standard Finish:** N/A
COM: 6.75 yards

Grover Swivel Chair

Width: 30 **Depth:** 36.5 **Height:** 36.5
AH: 24.5 **SH:** 20 **SD:** 24 **IW:** 20
Weight: 71 / 89 lbs **Cube:** 36.49

D	E	F	G	H	J	K _{COM}	L	M	N	O	P	Q	R	S	T	U	(# above U) *	S Nail	M Nail
2445	2463	2481	2499	2517	2535	2553	2571	2589	2607	2625	2643	2661	2679	2697	2715	2733	18 (Riser) + 2733 (U)	120	135

C-1452-01

Standard Pillows: N/A **Finish Req:** Y
Standard Cushions: Endurance **Standard Finish:** N/A
COM: 6 yards

Dellinger Lounge Chair

Width: 35 **Depth:** 36 **Height:** 35
AH: 25 **SH:** 19 **SD:** 24 **IW:** 20.5
Weight: 56 / 56 lbs **Cube:** 25.52

D	E	F	G	H	J	K _{COM}	L	M	N	O	P	Q	R	S	T	U	(# above U) *	S Nail	M Nail
2670	2688	2706	2724	2742	2760	2778	2796	2814	2832	2850	2868	2886	2904	2922	2940	2958	18 (Riser) + 2958 (U)	N/A	N/A

C-1452-20

Standard Pillows: N/A **Finish Req:** Y
Standard Cushions: High Resiliency 35 **Standard Finish:** N/A
COM: 2.5 yards

Dellinger Ottoman

Width: 22.5 **Depth:** 19.5 **Height:** 16
AH: - **SH:** - **SD:** - **IW:** -
Weight: 16 / 16 lbs **Cube:** 4.06

D	E	F	G	H	J	K _{COM}	L	M	N	O	P	Q	R	S	T	U	(# above U) *	S Nail	M Nail
945	954	963	972	981	990	999	1008	1017	1026	1035	1044	1053	1062	1071	1080	1089	9 (Riser) + 1089 (U)	N/A	N/A

C-1487-01

Standard Pillows: N/A **Finish Req:** Y
Standard Cushions: Endurance **Standard Finish:** N/A
COM: 6.5 yards

De Long Lounge Chair

Width: 30.75 **Depth:** 34 **Height:** 32
AH: 25.75 **SH:** 19.5 **SD:** 20 **IW:** 23
Weight: 69 / 79 lbs **Cube:** 19.36

D	E	F	G	H	J	K _{COM}	L	M	N	O	P	Q	R	S	T	U	(# above U) *	S Nail	M Nail
2670	2688	2706	2724	2742	2760	2778	2796	2814	2832	2850	2868	2886	2904	2922	2940	2958	18 (Riser) + 2958 (U)	N/A	N/A

C-1487-31

Standard Pillows: N/A **Finish Req:** Y
Standard Cushions: Endurance **Standard Finish:** N/A
COM: 6.5 yards

De Long Swivel Chair

Width: 30.75 **Depth:** 34 **Height:** 32
AH: 25.75 **SH:** 19.5 **SD:** 20 **IW:** 23
Weight: 79 / 89 lbs **Cube:** 19.36

D	E	F	G	H	J	K _{COM}	L	M	N	O	P	Q	R	S	T	U	(# above U) *	S Nail	M Nail
2745	2763	2781	2799	2817	2835	2853	2871	2889	2907	2925	2943	2961	2979	2997	3015	3033	18 (Riser) + 3033 (U)	N/A	N/A

C-1495-01

Standard Pillows: N/A **Finish Req:** Y
Standard Cushions: Endurance **Standard Finish:** N/A
COM: 4.5 yards

Dresden Lounge Chair

Width: 29 **Depth:** 30 **Height:** 32.75
AH: 25 **SH:** 20 **SD:** 20 **IW:** 20
Weight: 48 / 60 lbs **Cube:** 16.48

D	E	F	G	H	J	K _{COM}	L	M	N	O	P	Q	R	S	T	U	(# above U) *	S Nail	M Nail
2205	2220	2235	2250	2265	2280	2295	2310	2325	2340	2355	2370	2385	2400	2415	2430	2445	15 (Riser) + 2445 (U)	60	75

C-1495-20

Standard Pillows: N/A **Finish Req:** Y
Standard Cushions: High Resiliency 35 **Standard Finish:** N/A
COM: 1.75 yards

Dresden Ottoman

Width: 22.5 **Depth:** 19.5 **Height:** 17
AH: - **SH:** - **SD:** - **IW:** -
Weight: 17 / 26 lbs **Cube:** 10.77

D	E	F	G	H	J	K _{COM}	L	M	N	O	P	Q	R	S	T	U	(# above U) *	S Nail	M Nail
930	936	942	948	954	960	966	972	978	984	990	996	1002	1008	1014	1020	1026	6 (Riser) + 1026 (U)	30	N/A

UPHOLSTERY

C-1495-59

Standard Pillows: N/A **Finish Req:** Y
Standard Cushions: Endurance **Standard Finish:** N/A
COM: 5.25 yards

Dresden Tilt Back Chair

Width: 29 **Depth:** 32 **Height:** 36.75
AH: 25 **SH:** 20 **SD:** 20 **IW:** 20
Weight: 61 / 61 lbs **Cube:** 19.73

D	E	F	G	H	J	K _{COM}	L	M	N	O	P	Q	R	S	T	U	(# above U) *	S Nail	M Nail
2730	2745	2760	2775	2790	2805	2820	2835	2850	2865	2880	2895	2910	2925	2940	2955	2970	15 (Riser) + 2970 (U)	60	75

C-2601-01

Standard Pillows: (1) Kidney **Finish Req:** Y
Standard Cushions: Endurance **Standard Finish:** N/A
COM: 7 yards

Carlyle Lounge Chair

Width: 28.5 **Depth:** 35 **Height:** 37
AH: 18.5 **SH:** 19.5 **SD:** 19 **IW:** 23
Weight: 60 / 74 lbs **Cube:** 29.69

D	E	F	G	H	J	K _{COM}	L	M	N	O	P	Q	R	S	T	U	(# above U) *	S Nail	M Nail
2294	2318	2342	2366	2390	2414	2438	2462	2486	2510	2534	2558	2582	2606	2630	2654	2678	24 (Riser) + 2678 (U)	75	90

C-2601-25

Standard Pillows: (1) Kidney **Finish Req:** Y
Standard Cushions: Endurance **Standard Finish:** N/A
COM: 10.75 yards

Carlyle Chaise Lounge

Width: 28.5 **Depth:** 64 **Height:** 40
AH: 20 **SH:** 21 **SD:** 48 **IW:** 23
Weight: 105 / 135 lbs **Cube:** 55.51

D	E	F	G	H	J	K _{COM}	L	M	N	O	P	Q	R	S	T	U	(# above U) *	S Nail	M Nail
3165	3195	3225	3255	3285	3315	3345	3375	3405	3435	3465	3495	3525	3555	3585	3615	3645	30 (Riser) + 3645 (U)	90	105

C-2674-25

Standard Pillows: (2) Kidney **Finish Req:** Y
Standard Cushions: Endurance **Standard Finish:** N/A
COM: 9.75 yards

Countess Chaise Lounge

Width: 76.5 **Depth:** 27.5 **Height:** 30
AH: 30 **SH:** 22 **SD:** 28 **IW:** 45.5
Weight: 96 / 131 lbs **Cube:** 68.15

D	E	F	G	H	J	K _{COM}	L	M	N	O	P	Q	R	S	T	U	(# above U) *	S Nail	M Nail
3375	3402	3429	3456	3483	3510	3537	3564	3591	3618	3645	3672	3699	3726	3753	3780	3807	27 (Riser) + 3807 (U)	75	90

C-2702-50

Standard Pillows: N/A **Finish Req:** Y
Standard Cushions: Endurance **Standard Finish:** N/A
COM: 19 yards

Vincent Sofa

Width: 88.25 **Depth:** 40 **Height:** 41.5
AH: 23 **SH:** 21.5 **SD:** 21 **IW:** 80
Weight: 134 / 144 lbs **Cube:** 84.77

D	E	F	G	H	J	K _{COM}	L	M	N	O	P	Q	R	S	T	U	(# above U) *	S Nail	M Nail
4575	4629	4683	4737	4791	4845	4899	4953	5007	5061	5115	5169	5223	5277	5331	5385	5439	54 (Riser) + 5439 (U)	75	N/A

C-2709-50

Standard Pillows: N/A **Finish Req:** Y
Standard Cushions: Endurance **Standard Finish:** N/A
COM: 21 yards

Marshall Sofa

Width: 87.5 **Depth:** 39.5 **Height:** 38
AH: 26 **SH:** 20 **SD:** 21 **IW:** 73
Weight: 160 / 198 lbs **Cube:** 92.4

D	E	F	G	H	J	K _{COM}	L	M	N	O	P	Q	R	S	T	U	(# above U) *	S Nail	M Nail
4620	4680	4740	4800	4860	4920	4980	5040	5100	5160	5220	5280	5340	5400	5460	5520	5580	60 (Riser) + 5580 (U)	90	105

C-2735-50

Standard Pillows: N/A **Finish Req:** Y
Standard Cushions: Endurance **Standard Finish:** N/A
COM: 12.75 yards

Kyle Sofa

Width: 74.5 **Depth:** 35 **Height:** 31.5
AH: 25.5 **SH:** 20 **SD:** 23 **IW:** 68
Weight: 101 / 136 lbs **Cube:** 68.15

D	E	F	G	H	J	K _{COM}	L	M	N	O	P	Q	R	S	T	U	(# above U) *	S Nail	M Nail
3705	3741	3777	3813	3849	3885	3921	3957	3993	4029	4065	4101	4137	4173	4209	4245	4281	36 (Riser) + 4281 (U)	105	120

UPHOLSTERY

C-2745-50

SAVANNAH

Savannah Sofa with Tapered Leg

Two Backs over One Seat

Width: 88 Depth: 45 Height: 37.5

AH: 27 SH: 22 SD: 21.5 IW: 79

Weight: 165 / 205 lbs Cube: 79.34

Standard Pillows: N/A Finish Req: Y

Standard Cushions: Endurance Standard Finish: N/A

COM: 18 yards

D	E	F	G	H	J	K ^{COM}	L	M	N	O	P	Q	R	S	T	U	(# above U) *	S Nail	M Nail
4125	4179	4233	4287	4341	4395	4449	4503	4557	4611	4665	4719	4773	4827	4881	4935	4989	54 (Riser) + 4989 (U)	165	180

C-2746-50

SAVANNAH

Savannah Sofa with Tapered Leg

Two Backs over Two Seats

Width: 88 Depth: 45 Height: 37.5

AH: 27 SH: 22 SD: 21.5 IW: 79

Weight: 165 / 209 lbs Cube: 79.34

Standard Pillows: N/A Finish Req: Y

Standard Cushions: Endurance Standard Finish: N/A

COM: 19 yards

D	E	F	G	H	J	K ^{COM}	L	M	N	O	P	Q	R	S	T	U	(# above U) *	S Nail	M Nail
4125	4179	4233	4287	4341	4395	4449	4503	4557	4611	4665	4719	4773	4827	4881	4935	4989	54 (Riser) + 4989 (U)	165	180

C-2747-50

SAVANNAH

Savannah Grand Sofa with Tapered Leg

Three Backs over Three Seats

Width: 93 Depth: 40 Height: 41

AH: 27 SH: 22 SD: 21.5 IW: 83.5

Weight: 147 / 191 lbs Cube: 92.4

Standard Pillows: N/A Finish Req: Y

Standard Cushions: Endurance Standard Finish: N/A

COM: 20.75 yards

D	E	F	G	H	J	K ^{COM}	L	M	N	O	P	Q	R	S	T	U	(# above U) *	S Nail	M Nail
4455	4515	4575	4635	4695	4755	4815	4875	4935	4995	5055	5115	5175	5235	5295	5355	5415	60 (Riser) + 5415 (U)	165	180

C-2749-01

Smythe Lounge Chair

Width: 31.5 Depth: 41.5 Height: 36.5

AH: 25 SH: 19 SD: 22 IW: 24.5

Weight: 54 / 71 lbs Cube: 36.49

Standard Pillows: N/A Finish Req: Y

Standard Cushions: Endurance Standard Finish: N/A

COM: 9.25 yards

D	E	F	G	H	J	K ^{COM}	L	M	N	O	P	Q	R	S	T	U	(# above U) *	S Nail	M Nail
2520	2547	2574	2601	2628	2655	2682	2709	2736	2763	2790	2817	2844	2871	2898	2925	2952	27 (Riser) + 2952 (U)	90	105

C-2749-20

Smythe Ottoman

Width: 28 Depth: 21 Height: 16.5

AH: - SH: - SD: - IW: -

Weight: 26 / 35 lbs Cube: 10.77

Standard Pillows: N/A Finish Req: Y

Standard Cushions: Endurance Standard Finish: N/A

COM: 4.25 yards

D	E	F	G	H	J	K ^{COM}	L	M	N	O	P	Q	R	S	T	U	(# above U) *	S Nail	M Nail
1140	1152	1164	1176	1188	1200	1212	1224	1236	1248	1260	1272	1284	1296	1308	1320	1332	12 (Riser) + 1332 (U)	30	45

C-2749-50

Smythe Sofa

Width: 81.5 Depth: 41.5 Height: 36.5

AH: 25 SH: 19 SD: 22 IW: 74.5

Weight: 115 / 153 lbs Cube: 73.53

Standard Pillows: N/A Finish Req: Y

Standard Cushions: Endurance Standard Finish: N/A

COM: 19.25 yards

D	E	F	G	H	J	K ^{COM}	L	M	N	O	P	Q	R	S	T	U	(# above U) *	S Nail	M Nail
4185	4242	4299	4356	4413	4470	4527	4584	4641	4698	4755	4812	4869	4926	4983	5040	5097	57 (Riser) + 5097 (U)	135	150

C-2749-56

Smythe Extra Long Sofa

Width: 106.5 Depth: 41.5 Height: 36.5

AH: 25 SH: 19 SD: 22 IW: 99.5

Weight: 135 / 167 lbs Cube: 81.85

Standard Pillows: N/A Finish Req: Y

Standard Cushions: Endurance Standard Finish: N/A

COM: 24.25 yards

D	E	F	G	H	J	K ^{COM}	L	M	N	O	P	Q	R	S	T	U	(# above U) *	S Nail	M Nail
5025	5091	5157	5223	5289	5355	5421	5487	5553	5619	5685	5751	5817	5883	5949	6015	6081	66 (Riser) + 6081 (U)	165	180

UPHOLSTERY

C-2749-70

Standard Pillows: N/A **Finish Req:** Y
Standard Cushions: Endurance **Standard Finish:** N/A
COM: 13.25 yards

Smythe Loveseat

Width: 57 **Depth:** 41.5 **Height:** 36.5
AH: 25 **SH:** 19 **SD:** 22 **IW:** 50
Weight: 99 / 131 lbs **Cube:** 61.76

D	E	F	G	H	J	K ^{COM}	L	M	N	O	P	Q	R	S	T	U	(# above U) *	S Nail	M Nail
3450	3492	3534	3576	3618	3660	3702	3744	3786	3828	3870	3912	3954	3996	4038	4080	4122	42 (Riser) + 4122 (U)	120	135

C-2759-01

Standard Pillows: N/A **Finish Req:** Y
Standard Cushions: Endurance **Standard Finish:** N/A
COM: 6.5 yards

Kipton Lounge Chair

Width: 30.5 **Depth:** 34.25 **Height:** 32
AH: 28.25 **SH:** 19.75 **SD:** 20 **IW:** 20.5
Weight: 71 / 85 lbs **Cube:** 29.69

D	E	F	G	H	J	K ^{COM}	L	M	N	O	P	Q	R	S	T	U	(# above U) *	S Nail	M Nail
2820	2838	2856	2874	2892	2910	2928	2946	2964	2982	3000	3018	3036	3054	3072	3090	3108	18 (Riser) + 3108 (U)	135	N/A

C-2759-20

Standard Pillows: N/A **Finish Req:** Y
Standard Cushions: High Resiliency 30 **Standard Finish:** N/A
COM: 2.5 yards

Kipton Ottoman

Width: 26 **Depth:** 20 **Height:** 18
AH: - **SH:** - **SD:** - **IW:** -
Weight: 35 / 27 lbs **Cube:** 7.74

D	E	F	G	H	J	K ^{COM}	L	M	N	O	P	Q	R	S	T	U	(# above U) *	S Nail	M Nail
1125	1134	1143	1152	1161	1170	1179	1188	1197	1206	1215	1224	1233	1242	1251	1260	1269	9 (Riser) + 1269 (U)	30	N/A

C-2759-31

Standard Pillows: N/A **Finish Req:** Y
Standard Cushions: Endurance **Standard Finish:** N/A
COM: 6.5 yards

Kipton Swivel Chair

Width: 30.5 **Depth:** 34.25 **Height:** 32
AH: 28.25 **SH:** 19.75 **SD:** 20 **IW:** 20.5
Weight: 71 / 85 lbs **Cube:** 29.69

D	E	F	G	H	J	K ^{COM}	L	M	N	O	P	Q	R	S	T	U	(# above U) *	S Nail	M Nail
2850	2868	2886	2904	2922	2940	2958	2976	2994	3012	3030	3048	3066	3084	3102	3120	3138	18 (Riser) + 3138 (U)	135	N/A

C-2759-31-2

Standard Pillows: N/A **Finish Req:** N
Standard Cushions: Endurance **Standard Finish:** Nickel
COM: 6.5 yards

Kipton Swivel Chair

Width: 30.5 **Depth:** 34.25 **Height:** 32
AH: 28.25 **SH:** 19.75 **SD:** 20 **IW:** 20.5
Weight: 71 / 71 lbs **Cube:** 19.34

D	E	F	G	H	J	K ^{COM}	L	M	N	O	P	Q	R	S	T	U	(# above U) *	S Nail	M Nail
3015	3033	3051	3069	3087	3105	3123	3141	3159	3177	3195	3213	3231	3249	3267	3285	3303	18 (Riser) + 3303 (U)	135	N/A

C-2759-31-7

Standard Pillows: N/A **Finish Req:** N
Standard Cushions: Endurance **Standard Finish:** Bright Brass
COM: 6.5 yards

Kipton Swivel Chair

Width: 30.5 **Depth:** 34.25 **Height:** 32
AH: 28.25 **SH:** 19.75 **SD:** 20 **IW:** 20.5
Weight: 71 / 85 lbs **Cube:** 29.69

D	E	F	G	H	J	K ^{COM}	L	M	N	O	P	Q	R	S	T	U	(# above U) *	S Nail	M Nail
3015	3033	3051	3069	3087	3105	3123	3141	3159	3177	3195	3213	3231	3249	3267	3285	3303	18 (Riser) + 3303 (U)	135	N/A

C-2759-50

Standard Pillows: N/A **Finish Req:** Y
Standard Cushions: Endurance **Standard Finish:** N/A
COM: 13.5 yards

Kipton Sofa

Width: 84 **Depth:** 34.25 **Height:** 32
AH: 28.25 **SH:** 19.75 **SD:** 20 **IW:** 76
Weight: 125 / 163 lbs **Cube:** 79.34

D	E	F	G	H	J	K ^{COM}	L	M	N	O	P	Q	R	S	T	U	(# above U) *	S Nail	M Nail
4275	4314	4353	4392	4431	4470	4509	4548	4587	4626	4665	4704	4743	4782	4821	4860	4899	39 (Riser) + 4899 (U)	210	N/A

UPHOLSTERY

C-2779-01

Standard Pillows: N/A **Finish Req:** Y
Standard Cushions: Endurance **Standard Finish:** N/A
COM: 9.25 yards

Stuart Wing Chair

Width: 28.5 **Depth:** 41.5 **Height:** 43.5
AH: 25.5 **SH:** 22 **SD:** 21.5 **IW:** 21.5
Weight: 90 / 104 lbs **Cube:** 41.32

D	E	F	G	H	J	K COM	L	M	N	O	P	Q	R	S	T	U	(# above U) *	S Nail	M Nail
2730	2757	2784	2811	2838	2865	2892	2919	2946	2973	3000	3027	3054	3081	3108	3135	3162	27 (Riser) + 3162 (U)	90	N/A

C-2779-20

Standard Pillows: N/A **Finish Req:** Y
Standard Cushions: Endurance **Standard Finish:** N/A
COM: 2.25 yards

Stuart Ottoman

Width: 25 **Depth:** 19 **Height:** 20
AH: - **SH:** 20 **SD:** - **IW:** -
Weight: 25 / 30 lbs **Cube:** 10.55

D	E	F	G	H	J	K COM	L	M	N	O	P	Q	R	S	T	U	(# above U) *	S Nail	M Nail
1110	1119	1128	1137	1146	1155	1164	1173	1182	1191	1200	1209	1218	1227	1236	1245	1254	9 (Riser) + 1254 (U)	30	N/A

C-2779-50

Standard Pillows: N/A **Finish Req:** Y
Standard Cushions: Endurance **Standard Finish:** N/A
COM: 19.25 yards

Stuart Sofa

Width: 84.5 **Depth:** 41.5 **Height:** 43.5
AH: 25.5 **SH:** 22 **SD:** 21.5 **IW:** 77.5
Weight: 155 / 200 lbs **Cube:** 87.69

D	E	F	G	H	J	K COM	L	M	N	O	P	Q	R	S	T	U	(# above U) *	S Nail	M Nail
4275	4329	4383	4437	4491	4545	4599	4653	4707	4761	4815	4869	4923	4977	5031	5085	5139	54 (Riser) + 5139 (U)	150	N/A

C-2786-01

Standard Pillows: N/A **Finish Req:** Y
Standard Cushions: Endurance **Standard Finish:** N/A
COM: 7.25 yards

Fenton Lounge Chair

Width: 29.5 **Depth:** 35.5 **Height:** 35.5
AH: 22 **SH:** 20 **SD:** 21.5 **IW:** 25
Weight: 60 / 74 lbs **Cube:** 29.69

D	E	F	G	H	J	K COM	L	M	N	O	P	Q	R	S	T	U	(# above U) *	S Nail	M Nail
2520	2544	2568	2592	2616	2640	2664	2688	2712	2736	2760	2784	2808	2832	2856	2880	2904	24 (Riser) + 2904 (U)	45	60

C-2786-20

Standard Pillows: N/A **Finish Req:** Y
Standard Cushions: Endurance **Standard Finish:** N/A
COM: 2.5 yards

Fenton Ottoman

Width: 25.5 **Depth:** 19.5 **Height:** 19
AH: - **SH:** - **SD:** - **IW:** -
Weight: 25 / 30 lbs **Cube:** 10.55

D	E	F	G	H	J	K COM	L	M	N	O	P	Q	R	S	T	U	(# above U) *	S Nail	M Nail
1185	1194	1203	1212	1221	1230	1239	1248	1257	1266	1275	1284	1293	1302	1311	1320	1329	9 (Riser) + 1329 (U)	30	45

C-2799-50

Standard Pillows: N/A **Finish Req:** Y
Standard Cushions: Endurance **Standard Finish:** N/A
COM: 18.25 yards

Anson Sofa

Width: 79.5 **Depth:** 41 **Height:** 34
AH: 31.5 **SH:** 20.5 **SD:** 21 **IW:** 67.5
Weight: 150 / 185 lbs **Cube:** 73.53

D	E	F	G	H	J	K COM	L	M	N	O	P	Q	R	S	T	U	(# above U) *	S Nail	M Nail
4110	4164	4218	4272	4326	4380	4434	4488	4542	4596	4650	4704	4758	4812	4866	4920	4974	54 (Riser) + 4974 (U)	Std.	N/A

C-3758-57

Standard Pillows: N/A **Finish Req:** Y
Standard Cushions: Endurance **Standard Finish:** N/A
COM: 18.5 yards

Ayden Curved Corner Sofa

Width: 100 **Depth:** 47 **Height:** 36
AH: 25.5 **SH:** 21.5 **SD:** 21 **IW:** 74
Weight: 210 / 258 lbs **Cube:** 129.08

D	E	F	G	H	J	K COM	L	M	N	O	P	Q	R	S	T	U	(# above U) *	S Nail	M Nail
5445	5499	5553	5607	5661	5715	5769	5823	5877	5931	5985	6039	6093	6147	6201	6255	6309	54 (Riser) + 6309 (U)	75	90

UPHOLSTERY

C-5135-01

Standard Pillows: N/A **Finish Req:** Y
Standard Cushions: Endurance **Standard Finish:** N/A
COM: 5.25 yards

Casper Wing Chair

Width: 33 **Depth:** 32.5 **Height:** 42
AH: 21.5 **SH:** 20 **SD:** 21.5 **IW:** 21.5
Weight: 60 / 75 lbs **Cube:** 27.3

D	E	F	G	H	J	K _{COM}	L	M	N	O	P	Q	R	S	T	U	(# above U) *	S Nail	M Nail
2385	2400	2415	2430	2445	2460	2475	2490	2505	2520	2535	2550	2565	2580	2595	2610	2625	15 (Riser) + 2625 (U)	75	90

C-5138-01

Standard Pillows: N/A **Finish Req:** Y
Standard Cushions: Endurance **Standard Finish:** N/A
COM: 7.5 yards

Walker Wing Chair

Width: 29.5 **Depth:** 33 **Height:** 43
AH: 22.5 **SH:** 19 **SD:** 22 **IW:** 21.5
Weight: 65 / 81 lbs **Cube:** 34.38

D	E	F	G	H	J	K _{COM}	L	M	N	O	P	Q	R	S	T	U	(# above U) *	S Nail	M Nail
2415	2436	2457	2478	2499	2520	2541	2562	2583	2604	2625	2646	2667	2688	2709	2730	2751	21 (Riser) + 2751 (U)	105	120

C-5167-01

Standard Pillows: N/A **Finish Req:** Y
Standard Cushions: Endurance **Standard Finish:** N/A
COM: 6.5 yards

Tavia Wing Chair

Width: 31.5 **Depth:** 37 **Height:** 42.5
AH: 25 **SH:** 20 **SD:** 22 **IW:** 25
Weight: 60 / 78 lbs **Cube:** 34.38

D	E	F	G	H	J	K _{COM}	L	M	N	O	P	Q	R	S	T	U	(# above U) *	S Nail	M Nail
2820	2838	2856	2874	2892	2910	2928	2946	2964	2982	3000	3018	3036	3054	3072	3090	3108	18 (Riser) + 3108 (U)	Std.	30

C-5178-01

Standard Pillows: N/A **Finish Req:** Y
Standard Cushions: Endurance **Standard Finish:** N/A
COM: 6 yards

Downing Wing Chair

Width: 29.5 **Depth:** 35.5 **Height:** 46
AH: 23 **SH:** 20.5 **SD:** 23 **IW:** 21
Weight: 59 / 75 lbs **Cube:** 34.38

D	E	F	G	H	J	K _{COM}	L	M	N	O	P	Q	R	S	T	U	(# above U) *	S Nail	M Nail
2520	2538	2556	2574	2592	2610	2628	2646	2664	2682	2700	2718	2736	2754	2772	2790	2808	18 (Riser) + 2808 (U)	135	150

C-5192-01

Standard Pillows: (1) Kidney **Finish Req:** Y
Standard Cushions: Endurance **Standard Finish:** N/A
COM: 9 yards

Lawson Wing Chair

Width: 32.5 **Depth:** 33.5 **Height:** 44.5
AH: 22.5 **SH:** 22 **SD:** 17.5 **IW:** 26
Weight: 46 / 62 lbs **Cube:** 34.38

D	E	F	G	H	J	K _{COM}	L	M	N	O	P	Q	R	S	T	U	(# above U) *	S Nail	M Nail
3420	3450	3480	3510	3540	3570	3600	3630	3660	3690	3720	3750	3780	3810	3840	3870	3900	30 (Riser) + 3900 (U)	Std.	N/A

C-5197-01

Standard Pillows: (1) 14.5 x 22.5 Kidney **Finish Req:** Y
Standard Cushions: Endurance **Standard Finish:** N/A
COM: 7 yards
 Seat Depth 21 1/2" without kidney pillow

Martin Wing Chair

Width: 28 **Depth:** 35 **Height:** 43.5
AH: 25 **SH:** 21 **SD:** 16 **IW:** 25.5
Weight: 65 / 81 lbs **Cube:** 34.38

D	E	F	G	H	J	K _{COM}	L	M	N	O	P	Q	R	S	T	U	(# above U) *	S Nail	M Nail
2940	2964	2988	3012	3036	3060	3084	3108	3132	3156	3180	3204	3228	3252	3276	3300	3324	24 (Riser) + 3324 (U)	75	N/A

C-5216-01

Standard Pillows: N/A **Finish Req:** Y
Standard Cushions: Endurance **Standard Finish:** N/A
COM: 7 yards

Riverton Occasional Chair

Width: 32 **Depth:** 34.5 **Height:** 43
AH: 23 **SH:** 22 **SD:** 24 **IW:** 24.5
Weight: 55 / 71 lbs **Cube:** 34.38

D	E	F	G	H	J	K _{COM}	L	M	N	O	P	Q	R	S	T	U	(# above U) *	S Nail	M Nail
2970	2994	3018	3042	3066	3090	3114	3138	3162	3186	3210	3234	3258	3282	3306	3330	3354	24 (Riser) + 3354 (U)	120	N/A

UPHOLSTERY

C-5300-01

Standard Pillows: N/A **Finish Req:** Y
Standard Cushions: Endurance **Standard Finish:** N/A
COM: 7 yards

Felix Lounge Chair

Width: 34 **Depth:** 33 **Height:** 41
AH: 24.5 **SH:** 21 **SD:** 22.5 **IW:** 25
Weight: 70 / 85 lbs **Cube:** 34.38

D	E	F	G	H	J	K _{COM}	L	M	N	O	P	Q	R	S	T	U	(# above U) *	S Nail	M Nail
2535	2556	2577	2598	2619	2640	2661	2682	2703	2724	2745	2766	2787	2808	2829	2850	2871	21 (Riser) + 2871 (U)	75	90

C-5499-01

Standard Pillows: (1) Kidney **Finish Req:** Y
Standard Cushions: Endurance **Standard Finish:** N/A
COM: 5.25 yards

Chadwick Occasional Chair

Width: 30 **Depth:** 37 **Height:** 37.5
AH: 23 **SH:** 19 **SD:** 17.5 **IW:** 26.5
Weight: 61 / 78 lbs **Cube:** 36.49

Features natural cane accents that was handwoven using the peel of natural rattan. As with any natural product, nature's imperfections and hallmarks will be present in the cane materials. Cane is a handcrafted product dating back to the Ancient Egyptians.

D	E	F	G	H	J	K _{COM}	L	M	N	O	P	Q	R	S	T	U	(# above U) *	S Nail	M Nail
2760	2775	2790	2805	2820	2835	2850	2865	2880	2895	2910	2925	2940	2955	2970	2985	3000	15 (Riser) + 3000 (U)	N/A	N/A

C-5729-01

Standard Pillows: N/A **Finish Req:** Y
Standard Cushions: Endurance **Standard Finish:** N/A
COM: 6.75 yards

Mathis Lounge Chair

Width: 32 **Depth:** 34 **Height:** 37
AH: 25.5 **SH:** 20 **SD:** 21 **IW:** 20
Weight: 55 / 69 lbs **Cube:** 29.69

D	E	F	G	H	J	K _{COM}	L	M	N	O	P	Q	R	S	T	U	(# above U) *	S Nail	M Nail
2280	2298	2316	2334	2352	2370	2388	2406	2424	2442	2460	2478	2496	2514	2532	2550	2568	18 (Riser) + 2568 (U)	45	60

C-5747-40

Standard Pillows: N/A **Finish Req:** Y
Standard Cushions: Endurance **Standard Finish:** N/A
COM: 9 yards

Brinkley Settee

Width: 58.5 **Depth:** 31 **Height:** 44.5
AH: 20 **SH:** 19.5 **SD:** 20.5 **IW:** 51
Weight: 74 / 108 lbs **Cube:** 61.35

D	E	F	G	H	J	K _{COM}	L	M	N	O	P	Q	R	S	T	U	(# above U) *	S Nail	M Nail
3240	3264	3288	3312	3336	3360	3384	3408	3432	3456	3480	3504	3528	3552	3576	3600	3624	24 (Riser) + 3624 (U)	120	135

C-6033-01

Standard Pillows: (1) 15-1/2 x 26-1/2 Kidney **Finish Req:** Y
Standard Cushions: Endurance **Standard Finish:** N/A
COM: 6.5 yards

Justin Lounge Chair

Width: 30 **Depth:** 33.5 **Height:** 40.5
AH: - **SH:** 21.5 **SD:** 17 **IW:** 29.5
Weight: 50 / 66 lbs **Cube:** 34.38

D	E	F	G	H	J	K _{COM}	L	M	N	O	P	Q	R	S	T	U	(# above U) *	S Nail	M Nail
2295	2316	2337	2358	2379	2400	2421	2442	2463	2484	2505	2526	2547	2568	2589	2610	2631	21 (Riser) + 2631 (U)	45	60

C-6082-MS-2

Standard Pillows: N/A **Finish Req:** N
Standard Cushions: Endurance **Standard Finish:** Nickel
COM: 5.25 yards

Jamie Memory Swivel Chair

Width: 32 **Depth:** 30.5 **Height:** 32
AH: 23.5 **SH:** 20.5 **SD:** 24 **IW:** 22
Weight: 54 / 67 lbs **Cube:** 23.89

D	E	F	G	H	J	K _{COM}	L	M	N	O	P	Q	R	S	T	U	(# above U) *	S Nail	M Nail
2670	2685	2700	2715	2730	2745	2760	2775	2790	2805	2820	2835	2850	2865	2880	2895	2910	15 (Riser) + 2910 (U)	N/A	N/A

C-6082-MS-6

Standard Pillows: N/A **Finish Req:** N
Standard Cushions: Endurance **Standard Finish:** BRUSHED BRASS
COM: 5.25 yards

Jamie Memory Swivel Chair

Width: 32 **Depth:** 30.5 **Height:** 32
AH: 23.5 **SH:** 20.5 **SD:** 24 **IW:** 22
Weight: 54 / 67 lbs **Cube:** 23.89

D	E	F	G	H	J	K _{COM}	L	M	N	O	P	Q	R	S	T	U	(# above U) *	S Nail	M Nail
2670	2685	2700	2715	2730	2745	2760	2775	2790	2805	2820	2835	2850	2865	2880	2895	2910	15 (Riser) + 2910 (U)	N/A	N/A

UPHOLSTERY

C-6082-01

Standard Pillows: N/A **Finish Req:** Y
Standard Cushions: Endurance **Standard Finish:** N/A
COM: 4.75 yards

Jamie Lounge Chair

Width: 32 **Depth:** 30.5 **Height:** 32
AH: 23.5 **SH:** 20.5 **SD:** 24 **IW:** 22
Weight: 54 / 68 lbs **Cube:** 29.69

D	E	F	G	H	J	K _{COM}	L	M	N	O	P	Q	R	S	T	U	(# above U) *	S Nail	M Nail
2370	2385	2400	2415	2430	2445	2460	2475	2490	2505	2520	2535	2550	2565	2580	2595	2610	15 (Riser) + 2610 (U)	N/A	N/A

C-6101-31

Standard Pillows: N/A **Finish Req:** N
Standard Cushions: Endurance **Standard Finish:** N/A
COM: 7.25 yards

Barry Swivel Chair

Width: 33.5 **Depth:** 34.5 **Height:** 35
AH: 27 **SH:** 20.5 **SD:** 22 **IW:** 21
Weight: 60 / 74 lbs **Cube:** 29.69

D	E	F	G	H	J	K _{COM}	L	M	N	O	P	Q	R	S	T	U	(# above U) *	S Nail	M Nail
2070	2094	2118	2142	2166	2190	2214	2238	2262	2286	2310	2334	2358	2382	2406	2430	2454	24 (Riser) + 2454 (U)	N/A	N/A

C-6111-20

Standard Pillows: N/A **Finish Req:** Y
Standard Cushions: High Resiliency 30 **Standard Finish:** N/A
COM: 2.25 yards

Bosley Ottoman

Width: 26.5 **Depth:** 21 **Height:** 17.5
AH: - **SH:** - **SD:** - **IW:** -
Weight: 20 / 29 lbs **Cube:** 10.77

D	E	F	G	H	J	K _{COM}	L	M	N	O	P	Q	R	S	T	U	(# above U) *	S Nail	M Nail
975	981	987	993	999	1005	1011	1017	1023	1029	1035	1041	1047	1053	1059	1065	1071	6 (Riser) + 1071 (U)	N/A	Std.

C-6111-31

Standard Pillows: N/A **Finish Req:** N
Standard Cushions: Endurance **Standard Finish:** N/A
COM: 6.75 yards

Bosley Swivel Chair

Width: 33.5 **Depth:** 34.5 **Height:** 35
AH: 27 **SH:** 20.5 **SD:** 22 **IW:** 21
Weight: 60 / 74 lbs **Cube:** 29.69

D	E	F	G	H	J	K _{COM}	L	M	N	O	P	Q	R	S	T	U	(# above U) *	S Nail	M Nail
2190	2208	2226	2244	2262	2280	2298	2316	2334	2352	2370	2388	2406	2424	2442	2460	2478	18 (Riser) + 2478 (U)	N/A	Std.

C-6120-31

Standard Pillows: N/A **Finish Req:** N
Standard Cushions: Endurance **Standard Finish:** N/A
COM: 6.25 yards
Standard with leftside facing wireless charger for iPhone & Android Cellular Phones

Paterson Swivel Chair with Wireless Charger

Width: 33.5 **Depth:** 34 **Height:** 37.5
AH: 27 **SH:** 21.5 **SD:** 21 **IW:** 23
Weight: 85 / 85 lbs **Cube:** 24.71

D	E	F	G	H	J	K _{COM}	L	M	N	O	P	Q	R	S	T	U	(# above U) *	S Nail	M Nail
2295	2313	2331	2349	2367	2385	2403	2421	2439	2457	2475	2493	2511	2529	2547	2565	2583	18 (Riser) + 2583 (U)	45	60

C-6120-32

Standard Pillows: N/A **Finish Req:** N
Standard Cushions: Endurance **Standard Finish:** N/A
COM: 6.25 yards
Standard with leftside facing wireless charger for iPhone & Android Cellular Phones

Paterson Swivel Glider with Wireless Charger

Width: 33.5 **Depth:** 34 **Height:** 37.5
AH: 27 **SH:** 21.5 **SD:** 21 **IW:** 23
Weight: 85 / 85 lbs **Cube:** 24.71

D	E	F	G	H	J	K _{COM}	L	M	N	O	P	Q	R	S	T	U	(# above U) *	S Nail	M Nail
2445	2463	2481	2499	2517	2535	2553	2571	2589	2607	2625	2643	2661	2679	2697	2715	2733	18 (Riser) + 2733 (U)	45	60

C-6121-31

Standard Pillows: N/A **Finish Req:** N
Standard Cushions: Endurance **Standard Finish:** N/A
COM: 6.25 yards

Paterson Swivel Chair

Width: 33.5 **Depth:** 34 **Height:** 37.5
AH: 27 **SH:** 21.5 **SD:** 21 **IW:** 23
Weight: 75 / 85 lbs **Cube:** 28.5

D	E	F	G	H	J	K _{COM}	L	M	N	O	P	Q	R	S	T	U	(# above U) *	S Nail	M Nail
2145	2163	2181	2199	2217	2235	2253	2271	2289	2307	2325	2343	2361	2379	2397	2415	2433	18 (Riser) + 2433 (U)	45	60

UPHOLSTERY

C-6122-31

Paterson Swivel Chair with UV-C Phone Charger with Sanitation

Width: 33.5 Depth: 34 Height: 37.5
 AH: 27 SH: 21.5 SD: 21 IW: 23
 Weight: 85 / 85 lbs Cube: 24.71

Standard Pillows: N/A Finish Req: N
 Standard Cushions: Endurance Standard Finish: N/A
 COM: 6.25 yards
 Left Side Facing Ultraviolet Disinfecting & Charging unit for iPhone and Android cellular phones.

D	E	F	G	H	J	K ^{COM}	L	M	N	O	P	Q	R	S	T	U	(# above U) *	S Nail	M Nail
2295	2313	2331	2349	2367	2385	2403	2421	2439	2457	2475	2493	2511	2529	2547	2565	2583	18 (Riser) + 2583 (U)	45	60

C-6122-32

Paterson Swivel Glider with UV-C Phone Charger with Sanitation

Width: 33.5 Depth: 34 Height: 37.5
 AH: 27 SH: 21.5 SD: 21 IW: 23
 Weight: 85 / 85 lbs Cube: 24.71

Standard Pillows: N/A Finish Req: N
 Standard Cushions: Endurance Standard Finish: N/A
 COM: 6.25 yards
 Left Side Facing Ultraviolet Disinfecting & Charging unit for iPhone and Android cellular phones.

D	E	F	G	H	J	K ^{COM}	L	M	N	O	P	Q	R	S	T	U	(# above U) *	S Nail	M Nail
2445	2463	2481	2499	2517	2535	2553	2571	2589	2607	2625	2643	2661	2679	2697	2715	2733	18 (Riser) + 2733 (U)	45	60

C-6138-01

Bryson Lounge Chair

Width: 29 Depth: 32 Height: 32
 AH: 27 SH: 21 SD: 22 IW: 22
 Weight: 55 / 69 lbs Cube: 29.69

Standard Pillows: N/A Finish Req: Y
 Standard Cushions: Endurance Standard Finish: N/A
 COM: 5.25 yards

D	E	F	G	H	J	K ^{COM}	L	M	N	O	P	Q	R	S	T	U	(# above U) *	S Nail	M Nail
2130	2145	2160	2175	2190	2205	2220	2235	2250	2265	2280	2295	2310	2325	2340	2355	2370	15 (Riser) + 2370 (U)	45	60

C-6138-31

Bryson Swivel Chair

Width: 29 Depth: 32 Height: 32
 AH: 27 SH: 21 SD: 22 IW: 22
 Weight: 55 / 69 lbs Cube: 29.69

Standard Pillows: N/A Finish Req: N
 Standard Cushions: Endurance Standard Finish: N/A
 COM: 5.25 yards

D	E	F	G	H	J	K ^{COM}	L	M	N	O	P	Q	R	S	T	U	(# above U) *	S Nail	M Nail
2130	2145	2160	2175	2190	2205	2220	2235	2250	2265	2280	2295	2310	2325	2340	2355	2370	15 (Riser) + 2370 (U)	45	60

C-6198-31

Forester Swivel Chair

Width: 29 Depth: 34 Height: 31.75
 AH: 25.75 SH: 20 SD: 25 IW: 23
 Weight: 73 / 87 lbs Cube: 29.69

Standard Pillows: N/A Finish Req: Y
 Standard Cushions: Endurance Standard Finish: N/A
 COM: 5 yards

D	E	F	G	H	J	K ^{COM}	L	M	N	O	P	Q	R	S	T	U	(# above U) *	S Nail	M Nail
2790	2805	2820	2835	2850	2865	2880	2895	2910	2925	2940	2955	2970	2985	3000	3015	3030	15 (Riser) + 3030 (U)	75	N/A

C-6198-32

Forester Swivel Glider

Width: 29 Depth: 34 Height: 31.75
 AH: 25.75 SH: 20 SD: 25 IW: 23
 Weight: 73 / 73 lbs Cube: 18.11

Standard Pillows: N/A Finish Req: Y
 Standard Cushions: Endurance Standard Finish: N/A
 COM: 5 yards

D	E	F	G	H	J	K ^{COM}	L	M	N	O	P	Q	R	S	T	U	(# above U) *	S Nail	M Nail
2940	2955	2970	2985	3000	3015	3030	3045	3060	3075	3090	3105	3120	3135	3150	3165	3180	15 (Riser) + 3180 (U)	75	N/A

C-6207-01-6

Gramercy Occasional Chair

Width: 29.25 Depth: 32 Height: 34
 AH: 22.75 SH: 20 SD: 20 IW: 25
 Weight: 46 / 60 lbs Cube: 29.69

Standard Pillows: N/A Finish Req: N
 Standard Cushions: Endurance Standard Finish: BRUSHED BRASS
 COM: 4 yards

D	E	F	G	H	J	K ^{COM}	L	M	N	O	P	Q	R	S	T	U	(# above U) *	S Nail	M Nail
2850	2862	2874	2886	2898	2910	2922	2934	2946	2958	2970	2982	2994	3006	3018	3030	3042	12 (Riser) + 3042 (U)	N/A	N/A

UPHOLSTERY

C-6300-50-2

LIBBY LANGDON FOR FAIRFIELD
Tanner Sofa

Standard Pillows: N/A Finish Req: N
Standard Cushions: High Resiliency 35 Standard Finish: Nickel
COM: 8 yards

Width: 78.75 Depth: 34 Height: 33.75
AH: 23.25 SH: 19 SD: 23 IW: 68
Weight: 108 / 108 lbs Cube: 52.29

D	E	F	G	H	J	K _{COM}	L	M	N	O	P	Q	R	S	T	U	(# above U) *	S Nail	M Nail
3675	3705	3735	3765	3795	3825	3855	3885	3915	3945	3975	4005	4035	4065	4095	4125	4155	30 (Riser) + 4155 (U)	75	N/A

C-6300-50-6

LIBBY LANGDON FOR FAIRFIELD
Tanner Sofa

Standard Pillows: N/A Finish Req: N
Standard Cushions: High Resiliency 35 Standard Finish: BRUSHED BRASS
COM: 8 yards

Width: 78.75 Depth: 34 Height: 33.75
AH: 23.25 SH: 19 SD: 23 IW: 68
Weight: 108 / 108 lbs Cube: 52.29

D	E	F	G	H	J	K _{COM}	L	M	N	O	P	Q	R	S	T	U	(# above U) *	S Nail	M Nail
3675	3705	3735	3765	3795	3825	3855	3885	3915	3945	3975	4005	4035	4065	4095	4125	4155	30 (Riser) + 4155 (U)	75	N/A

C-6301-26

LIBBY LANGDON FOR FAIRFIELD
Derring Right Arm Facing Chaise

Standard Pillows: N/A Finish Req: Y
Standard Cushions: Endurance Standard Finish: N/A
COM: 9.5 yards
Brushed Brass ferrule.

Width: 71 Depth: 37 Height: 39
AH: - SH: 20.5 SD: 22 IW: -
Weight: 91 / 125 lbs Cube: 70.78

D	E	F	G	H	J	K _{COM}	L	M	N	O	P	Q	R	S	T	U	(# above U) *	S Nail	M Nail
3525	3552	3579	3606	3633	3660	3687	3714	3741	3768	3795	3822	3849	3876	3903	3930	3957	27 (Riser) + 3957 (U)	N/A	N/A

C-6301-27

LIBBY LANGDON FOR FAIRFIELD
Derring Left Arm Facing Chaise

Standard Pillows: N/A Finish Req: Y
Standard Cushions: Endurance Standard Finish: N/A
COM: 9.5 yards
Brushed Brass ferrule.

Width: 71 Depth: 37 Height: 39
AH: - SH: 20.5 SD: 22 IW: -
Weight: 91 / 125 lbs Cube: 70.78

D	E	F	G	H	J	K _{COM}	L	M	N	O	P	Q	R	S	T	U	(# above U) *	S Nail	M Nail
3525	3552	3579	3606	3633	3660	3687	3714	3741	3768	3795	3822	3849	3876	3903	3930	3957	27 (Riser) + 3957 (U)	N/A	N/A

C-6301-50

LIBBY LANGDON FOR FAIRFIELD
Derring Sofa

Standard Pillows: (2) 18 x 18 (2) 20 x 20 Finish Req: Y
Standard Cushions: Endurance Standard Finish: N/A
COM: 15.75 yards
Beech post with Brushed Brass ferrule. Features spaced back pillows.

Width: 81 Depth: 37 Height: 39
AH: 24 SH: 20.5 SD: 22 IW: 70
Weight: 122 / 162 lbs Cube: 73.53

D	E	F	G	H	J	K _{COM}	L	M	N	O	P	Q	R	S	T	U	(# above U) *	S Nail	M Nail
4785	4830	4875	4920	4965	5010	5055	5100	5145	5190	5235	5280	5325	5370	5415	5460	5505	45 (Riser) + 5505 (U)	N/A	N/A

C-6301-53

LIBBY LANGDON FOR FAIRFIELD
Derring Right Arm Facing Corner Sofa

Standard Pillows: (3) 20 x 20 (2) 18 x 18 Finish Req: Y
Standard Cushions: Endurance Standard Finish: N/A
COM: 21.75 yards
Brushed Brass ferrule.

Width: 111 Depth: 37 Height: 39
AH: 34 SH: 20.5 SD: 22 IW: 105
Weight: 153 / 205 lbs Cube: 112.18

D	E	F	G	H	J	K _{COM}	L	M	N	O	P	Q	R	S	T	U	(# above U) *	S Nail	M Nail
5685	5745	5805	5865	5925	5985	6045	6105	6165	6225	6285	6345	6405	6465	6525	6585	6645	60 (Riser) + 6645 (U)	N/A	N/A

C-6301-54

LIBBY LANGDON FOR FAIRFIELD
Derring Left Arm Facing Corner Sofa

Standard Pillows: (3) 20 x 20 (2) 18 x 18 Finish Req: Y
Standard Cushions: Endurance Standard Finish: N/A
COM: 21.75 yards
Brushed Brass ferrule.

Width: 111 Depth: 37 Height: 39
AH: 34 SH: 20.5 SD: 22 IW: 105
Weight: 153 / 205 lbs Cube: 112.18

D	E	F	G	H	J	K _{COM}	L	M	N	O	P	Q	R	S	T	U	(# above U) *	S Nail	M Nail
5685	5745	5805	5865	5925	5985	6045	6105	6165	6225	6285	6345	6405	6465	6525	6585	6645	60 (Riser) + 6645 (U)	N/A	N/A

UPHOLSTERY

C-6301-67

LIBBY LANGDON FOR FAIRFIELD
Derring Bumper Ottoman

Standard Pillows: N/A **Finish Req:** Y
Standard Cushions: Endurance **Standard Finish:** N/A
COM: 3.75 yards
 Brushed Brass ferrule.

Width: 36 **Depth:** 29 **Height:** 20.5
AH: - **SH:** 20.5 **SD:** 29 **IW:** 36
Weight: 26 / 39 lbs **Cube:** 16.92

D	E	F	G	H	J	K _{COM}	L	M	N	O	P	Q	R	S	T	U	(# above U) *	S Nail	M Nail
1650	1662	1674	1686	1698	1710	1722	1734	1746	1758	1770	1782	1794	1806	1818	1830	1842	12 (Riser) + 1842 (U)	N/A	N/A

C-6301-71

LIBBY LANGDON FOR FAIRFIELD
Derring Right Arm Facing Loveseat

Standard Pillows: (2) 20 x 20 (1) 18 x 18 **Finish Req:** Y
Standard Cushions: Endurance **Standard Finish:** N/A
COM: 17.75 yards
 Brushed Brass ferrule.

Width: 75 **Depth:** 37 **Height:** 39
AH: 24 **SH:** 20.5 **SD:** 22 **IW:** 70
Weight: 120 / 154 lbs **Cube:** 70.78

D	E	F	G	H	J	K _{COM}	L	M	N	O	P	Q	R	S	T	U	(# above U) *	S Nail	M Nail
4485	4527	4569	4611	4653	4695	4737	4779	4821	4863	4905	4947	4989	5031	5073	5115	5157	42 (Riser) + 5157 (U)	N/A	N/A

C-6301-72

LIBBY LANGDON FOR FAIRFIELD
Derring Left Arm Facing Loveseat

Standard Pillows: N/A **Finish Req:** Y
Standard Cushions: Endurance **Standard Finish:** N/A
COM: 17.75 yards
 Brushed Brass ferrule.

Width: 75 **Depth:** 37 **Height:** 39
AH: 24 **SH:** 20.5 **SD:** 22 **IW:** 70
Weight: 120 / 154 lbs **Cube:** 70.78

D	E	F	G	H	J	K _{COM}	L	M	N	O	P	Q	R	S	T	U	(# above U) *	S Nail	M Nail
4485	4527	4569	4611	4653	4695	4737	4779	4821	4863	4905	4947	4989	5031	5073	5115	5157	42 (Riser) + 5157 (U)	N/A	N/A

C-6302-50

LIBBY LANGDON FOR FAIRFIELD
Ryerson Sofa
 Bench Seat Cushion

Standard Pillows: N/A **Finish Req:** Y
Standard Cushions: Endurance **Standard Finish:** N/A
COM: 14.25 yards
 Features bench seat cushion.

Width: 86.5 **Depth:** 38 **Height:** 30.5
AH: 24.5 **SH:** 20.5 **SD:** 23 **IW:** 76
Weight: 160 / 198 lbs **Cube:** 79.34

D	E	F	G	H	J	K _{COM}	L	M	N	O	P	Q	R	S	T	U	(# above U) *	S Nail	M Nail
5085	5127	5169	5211	5253	5295	5337	5379	5421	5463	5505	5547	5589	5631	5673	5715	5757	42 (Riser) + 5757 (U)	N/A	N/A

C-6303-50

LIBBY LANGDON FOR FAIRFIELD
Barrett Sofa
 Bench Seat Cushion

Standard Pillows: N/A **Finish Req:** Y
Standard Cushions: Endurance **Standard Finish:** N/A
COM: 14.5 yards
 Features bench seat cushion.

Width: 84.75 **Depth:** 36.5 **Height:** 33
AH: 24.25 **SH:** 20.75 **SD:** 21 **IW:** 74
Weight: 130 / 168 lbs **Cube:** 79.34

D	E	F	G	H	J	K _{COM}	L	M	N	O	P	Q	R	S	T	U	(# above U) *	S Nail	M Nail
4875	4920	4965	5010	5055	5100	5145	5190	5235	5280	5325	5370	5415	5460	5505	5550	5595	45 (Riser) + 5595 (U)	90	105

C-6304-01

LIBBY LANGDON FOR FAIRFIELD
Remy Lounge Chair

Standard Pillows: N/A **Finish Req:** Y
Standard Cushions: Endurance **Standard Finish:** N/A
COM: 7 yards

Width: 32.5 **Depth:** 38 **Height:** 37
AH: 23.5 **SH:** 20 **SD:** 22 **IW:** 23
Weight: 58 / 75 lbs **Cube:** 36.49

D	E	F	G	H	J	K _{COM}	L	M	N	O	P	Q	R	S	T	U	(# above U) *	S Nail	M Nail
2700	2721	2742	2763	2784	2805	2826	2847	2868	2889	2910	2931	2952	2973	2994	3015	3036	21 (Riser) + 3036 (U)	45	60

C-6304-01-9

LIBBY LANGDON FOR FAIRFIELD
Remy Lounge Chair

Standard Pillows: N/A **Finish Req:** N
Standard Cushions: Endurance **Standard Finish:** Champagne
COM: 7 yards

Width: 32.5 **Depth:** 38 **Height:** 37
AH: 23.5 **SH:** 20 **SD:** 22 **IW:** 23
Weight: 58 / 75 lbs **Cube:** 26.44

D	E	F	G	H	J	K _{COM}	L	M	N	O	P	Q	R	S	T	U	(# above U) *	S Nail	M Nail
2775	2796	2817	2838	2859	2880	2901	2922	2943	2964	2985	3006	3027	3048	3069	3090	3111	21 (Riser) + 3111 (U)	45	60

UPHOLSTERY

C-6304-20

LIBBY LANGDON FOR FAIRFIELD

Remy Ottoman

Standard Pillows: N/A Finish Req: Y

Standard Cushions: High Resiliency 30 Standard Finish: N/A

COM: 3.25 yards

Width: 31 Depth: 23 Height: 19

AH: - SH: - SD: - IW: -

Weight: 23 / 32 lbs Cube: 10.77

D	E	F	G	H	J	K _{COM}	L	M	N	O	P	Q	R	S	T	U	(# above U) *	S Nail	M Nail
1320	1329	1338	1347	1356	1365	1374	1383	1392	1401	1410	1419	1428	1437	1446	1455	1464	9 (Riser) + 1464 (U)	30	45

C-6304-20-9

LIBBY LANGDON FOR FAIRFIELD

Remy Ottoman

Standard Pillows: N/A Finish Req: N

Standard Cushions: High Resiliency 30 Standard Finish: Champagne

COM: 3.25 yards

Width: 31 Depth: 23 Height: 19

AH: - SH: - SD: - IW: -

Weight: 23 / 32 lbs Cube: 10.77

D	E	F	G	H	J	K _{COM}	L	M	N	O	P	Q	R	S	T	U	(# above U) *	S Nail	M Nail
1410	1419	1428	1437	1446	1455	1464	1473	1482	1491	1500	1509	1518	1527	1536	1545	1554	9 (Riser) + 1554 (U)	30	45

C-6304-50

LIBBY LANGDON FOR FAIRFIELD

Remy Sofa

Standard Pillows: N/A Finish Req: Y

Standard Cushions: Endurance Standard Finish: N/A

COM: 16.5 yards

Width: 86.5 Depth: 38 Height: 37

AH: 23.5 SH: 20 SD: 22 IW: 77

Weight: 130 / 168 lbs Cube: 79.34

D	E	F	G	H	J	K _{COM}	L	M	N	O	P	Q	R	S	T	U	(# above U) *	S Nail	M Nail
4875	4890	4905	4920	4935	4950	4965	4980	4995	5010	5025	5040	5055	5070	5085	5100	5115	15 (Riser) + 5115 (U)	75	90

C-6304-50-9

LIBBY LANGDON FOR FAIRFIELD

Remy Sofa

Standard Pillows: N/A Finish Req: N

Standard Cushions: Endurance Standard Finish: Champagne

COM: 16.5 yards

Width: 86.5 Depth: 38 Height: 37

AH: 23.5 SH: 20 SD: 22 IW: 77

Weight: 130 / 168 lbs Cube: 79.34

D	E	F	G	H	J	K _{COM}	L	M	N	O	P	Q	R	S	T	U	(# above U) *	S Nail	M Nail
5100	5145	5190	5235	5280	5325	5370	5415	5460	5505	5550	5595	5640	5685	5730	5775	5820	45 (Riser) + 5820 (U)	75	90

C-6311-26

LIBBY LANGDON FOR FAIRFIELD

Derring Right Arm Facing Chaise

Standard Pillows: N/A Finish Req: Y

Standard Cushions: Endurance Standard Finish: N/A

COM: 9.5 yards

Beech post with Brushed Brass ferrule. Features non-spaced back pillows.

Width: 71 Depth: 37 Height: 39

AH: - SH: 20.5 SD: 22 IW: -

Weight: 91 / 125 lbs Cube: 70.78

D	E	F	G	H	J	K _{COM}	L	M	N	O	P	Q	R	S	T	U	(# above U) *	S Nail	M Nail
3585	3612	3639	3666	3693	3720	3747	3774	3801	3828	3855	3882	3909	3936	3963	3990	4017	27 (Riser) + 4017 (U)	N/A	N/A

C-6311-27

LIBBY LANGDON FOR FAIRFIELD

Derring Left Arm Facing Chaise

Standard Pillows: N/A Finish Req: Y

Standard Cushions: Endurance Standard Finish: N/A

COM: 9.5 yards

Beech post with Brushed Brass ferrule. Features spaced back pillows.

Width: 71 Depth: 37 Height: 39

AH: - SH: 20.5 SD: 22 IW: -

Weight: 91 / 125 lbs Cube: 70.78

D	E	F	G	H	J	K _{COM}	L	M	N	O	P	Q	R	S	T	U	(# above U) *	S Nail	M Nail
3585	3612	3639	3666	3693	3720	3747	3774	3801	3828	3855	3882	3909	3936	3963	3990	4017	27 (Riser) + 4017 (U)	N/A	N/A

C-6311-50

LIBBY LANGDON FOR FAIRFIELD

Derring Sofa

Standard Pillows: N/A Finish Req: Y

Standard Cushions: Endurance Standard Finish: N/A

COM: 16 yards

Beech post with Brushed Brass ferrule. Features non-spaced back pillows.

Width: 81 Depth: 37 Height: 39

AH: 24 SH: 20.5 SD: 22 IW: 70

Weight: 122 / 162 lbs Cube: 73.53

D	E	F	G	H	J	K _{COM}	L	M	N	O	P	Q	R	S	T	U	(# above U) *	S Nail	M Nail
4785	4830	4875	4920	4965	5010	5055	5100	5145	5190	5235	5280	5325	5370	5415	5460	5505	45 (Riser) + 5505 (U)	N/A	N/A

UPHOLSTERY

C-6311-53

LIBBY LANGDON FOR FAIRFIELD

Derring Right Arm Facing Corner Sofa

Width: 111 Depth: 37 Height: 39
 AH: 34 SH: 20.5 SD: 22 IW: 105
 Weight: 153 / 205 lbs Cube: 112.18

Standard Pillows: (2) 18 x 18, (3) 20 x 20 Finish Req: Y
 Standard Cushions: Endurance Standard Finish: N/A
 COM: 21.75 yards
 Beech post with Brushed Brass ferrule. Features non-spaced back pillows.

D	E	F	G	H	J	K _{COM}	L	M	N	O	P	Q	R	S	T	U	(# above U) *	S Nail	M Nail
6075	6135	6195	6255	6315	6375	6435	6495	6555	6615	6675	6735	6795	6855	6915	6975	7035	60 (Riser) + 7035 (U)	N/A	N/A

C-6311-54

LIBBY LANGDON FOR FAIRFIELD

Derring Left Arm Facing Corner Sofa

Width: 111 Depth: 37 Height: 39
 AH: 34 SH: 20.5 SD: 22 IW: 105
 Weight: 153 / 205 lbs Cube: 112.18

Standard Pillows: (2) 18 x 18, (3) 20 x 20 Finish Req: Y
 Standard Cushions: Endurance Standard Finish: N/A
 COM: 21.75 yards
 Beech post with Brushed Brass ferrule. Features non-spaced back pillows.

D	E	F	G	H	J	K _{COM}	L	M	N	O	P	Q	R	S	T	U	(# above U) *	S Nail	M Nail
6075	6135	6195	6255	6315	6375	6435	6495	6555	6615	6675	6735	6795	6855	6915	6975	7035	60 (Riser) + 7035 (U)	N/A	N/A

C-6311-67

LIBBY LANGDON FOR FAIRFIELD

Derring Bumper Ottoman

Width: 36 Depth: 29 Height: 20.5
 AH: - SH: 20.5 SD: 29 IW: 36
 Weight: 26 / 39 lbs Cube: 16.92

Standard Pillows: N/A Finish Req: Y
 Standard Cushions: Endurance Standard Finish: N/A
 COM: 3.75 yards
 Beech post with Brushed Brass ferrule.

D	E	F	G	H	J	K _{COM}	L	M	N	O	P	Q	R	S	T	U	(# above U) *	S Nail	M Nail
1650	1662	1674	1686	1698	1710	1722	1734	1746	1758	1770	1782	1794	1806	1818	1830	1842	12 (Riser) + 1842 (U)	N/A	N/A

C-6311-71

LIBBY LANGDON FOR FAIRFIELD

Derring Right Arm Facing Loveseat

Width: 76 Depth: 37 Height: 39
 AH: 34 SH: 20.5 SD: 22 IW: 70
 Weight: 106 / 106 lbs Cube: 63.46

Standard Pillows: (2) 20 x 20 (1) 18 x 18 Finish Req: Y
 Standard Cushions: Endurance Standard Finish: N/A
 COM: 15 yards
 Beech post with Brushed Brass ferrule. Features non-spaced back pillows.

D	E	F	G	H	J	K _{COM}	L	M	N	O	P	Q	R	S	T	U	(# above U) *	S Nail	M Nail
4485	4533	4581	4629	4677	4725	4773	4821	4869	4917	4965	5013	5061	5109	5157	5205	5253	48 (Riser) + 5253 (U)	N/A	N/A

C-6311-72

LIBBY LANGDON FOR FAIRFIELD

Derring Left Arm Facing Loveseat

Width: 76 Depth: 37 Height: 39
 AH: 34 SH: 20.5 SD: 22 IW: 70
 Weight: 106 / 106 lbs Cube: 63.46

Standard Pillows: (2) 20 x 20 (1) 18 x 18 Finish Req: Y
 Standard Cushions: Endurance Standard Finish: N/A
 COM: 15 yards
 Beech post with Brushed Brass ferrule. Features non-spaced back pillows.

D	E	F	G	H	J	K _{COM}	L	M	N	O	P	Q	R	S	T	U	(# above U) *	S Nail	M Nail
4485	4533	4581	4629	4677	4725	4773	4821	4869	4917	4965	5013	5061	5109	5157	5205	5253	48 (Riser) + 5253 (U)	N/A	N/A

C-6312-50

LIBBY LANGDON FOR FAIRFIELD

Ryerson Sofa

Width: 86.5 Depth: 38 Height: 30.5
 AH: 24.5 SH: 20.5 SD: 23 IW: 76
 Weight: 199 / 198 lbs Cube: 79.34

Standard Pillows: N/A Finish Req: Y
 Standard Cushions: Endurance Standard Finish: N/A
 COM: 15 yards
 Features non-spaced back pillows.

D	E	F	G	H	J	K _{COM}	L	M	N	O	P	Q	R	S	T	U	(# above U) *	S Nail	M Nail
4950	4992	5034	5076	5118	5160	5202	5244	5286	5328	5370	5412	5454	5496	5538	5580	5622	42 (Riser) + 5622 (U)	N/A	N/A

C-6313-50

LIBBY LANGDON FOR FAIRFIELD

Barrett Sofa

Width: 84.75 Depth: 36.5 Height: 33
 AH: 24.25 SH: 20.75 SD: 21 IW: 74
 Weight: 169 / 168 lbs Cube: 79.34

Standard Pillows: N/A Finish Req: Y
 Standard Cushions: Endurance Standard Finish: N/A
 COM: 16.25 yards
 Features non-spaced back pillows.

D	E	F	G	H	J	K _{COM}	L	M	N	O	P	Q	R	S	T	U	(# above U) *	S Nail	M Nail
4875	4920	4965	5010	5055	5100	5145	5190	5235	5280	5325	5370	5415	5460	5505	5550	5595	45 (Riser) + 5595 (U)	90	105

UPHOLSTERY

C-6400-01

LIBBY LANGDON FOR FAIRFIELD
Rosewood Lounge Chair

Standard Pillows: N/A Finish Req: Y
Standard Cushions: Endurance Standard Finish: N/A
COM: 5.5 yards

Width: 28.5 Depth: 36 Height: 32.5
AH: 24 SH: 20 SD: 21.5 IW: 19.5
Weight: 56 / 70 lbs Cube: 29.69

D	E	F	G	H	J	K _{COM}	L	M	N	O	P	Q	R	S	T	U	(# above U) *	S Nail	M Nail
2670	2685	2700	2715	2730	2745	2760	2775	2790	2805	2820	2835	2850	2865	2880	2895	2910	15 (Riser) + 2910 (U)	45	60

C-6400-20

LIBBY LANGDON FOR FAIRFIELD
Rosewood Ottoman

Standard Pillows: N/A Finish Req: Y
Standard Cushions: High Resiliency 30 Standard Finish: N/A
COM: 2 yards

Width: 25 Depth: 21 Height: 17.5
AH: - SH: - SD: - IW: -
Weight: 15 / 24 lbs Cube: 10.77

D	E	F	G	H	J	K _{COM}	L	M	N	O	P	Q	R	S	T	U	(# above U) *	S Nail	M Nail
1245	1254	1263	1272	1281	1290	1299	1308	1317	1326	1335	1344	1353	1362	1371	1380	1389	9 (Riser) + 1389 (U)	30	45

C-6401-01

LIBBY LANGDON FOR FAIRFIELD
Colby Lounge Chair

Standard Pillows: N/A Finish Req: Y
Standard Cushions: Endurance Standard Finish: N/A
COM: 6.5 yards

Width: 28.5 Depth: 38 Height: 34
AH: 16 SH: 20 SD: 20 IW: 24.5
Weight: 50 / 67 lbs Cube: 36.49

D	E	F	G	H	J	K _{COM}	L	M	N	O	P	Q	R	S	T	U	(# above U) *	S Nail	M Nail
2355	2373	2391	2409	2427	2445	2463	2481	2499	2517	2535	2553	2571	2589	2607	2625	2643	18 (Riser) + 2643 (U)	75	90

C-6401-31

LIBBY LANGDON FOR FAIRFIELD
Colby Swivel Chair

Standard Pillows: N/A Finish Req: N
Standard Cushions: Endurance Standard Finish: N/A
COM: 6.5 yards

Width: 28.5 Depth: 38 Height: 34
AH: 16 SH: 20 SD: 20 IW: 24.5
Weight: 50 / 67 lbs Cube: 36.49

D	E	F	G	H	J	K _{COM}	L	M	N	O	P	Q	R	S	T	U	(# above U) *	S Nail	M Nail
2355	2373	2391	2409	2427	2445	2463	2481	2499	2517	2535	2553	2571	2589	2607	2625	2643	18 (Riser) + 2643 (U)	75	90

C-6403-01-2

LIBBY LANGDON FOR FAIRFIELD
Westway Lounge Chair

Standard Pillows: N/A Finish Req: N
Standard Cushions: Endurance Standard Finish: Nickel
COM: 6.5 yards

Width: 32 Depth: 36.5 Height: 34.5
AH: 23.25 SH: 20 SD: 22 IW: 22
Weight: 63 / 80 lbs Cube: 36.49

D	E	F	G	H	J	K _{COM}	L	M	N	O	P	Q	R	S	T	U	(# above U) *	S Nail	M Nail
2595	2613	2631	2649	2667	2685	2703	2721	2739	2757	2775	2793	2811	2829	2847	2865	2883	18 (Riser) + 2883 (U)	120	135

C-6403-01-6

LIBBY LANGDON FOR FAIRFIELD
Westway Lounge Chair

Standard Pillows: N/A Finish Req: N
Standard Cushions: Endurance Standard Finish: BRUSHED BRASS
COM: 6.5 yards

Width: 32 Depth: 36.5 Height: 34.5
AH: 23.25 SH: 20 SD: 22 IW: 22
Weight: 63 / 80 lbs Cube: 36.49

D	E	F	G	H	J	K _{COM}	L	M	N	O	P	Q	R	S	T	U	(# above U) *	S Nail	M Nail
2595	2613	2631	2649	2667	2685	2703	2721	2739	2757	2775	2793	2811	2829	2847	2865	2883	18 (Riser) + 2883 (U)	120	135

C-6403-20-2

LIBBY LANGDON FOR FAIRFIELD
Westway Ottoman

Standard Pillows: N/A Finish Req: N
Standard Cushions: High Resiliency 30 Standard Finish: Nickel
COM: 2.75 yards

Width: 26 Depth: 20 Height: 18
AH: - SH: - SD: - IW: -
Weight: 30 / 40 lbs Cube: 5.41

D	E	F	G	H	J	K _{COM}	L	M	N	O	P	Q	R	S	T	U	(# above U) *	S Nail	M Nail
1185	1197	1209	1221	1233	1245	1257	1269	1281	1293	1305	1317	1329	1341	1353	1365	1377	12 (Riser) + 1377 (U)	30	45

UPHOLSTERY

C-6403-20-6

LIBBY LANGDON FOR FAIRFIELD
Westway Ottoman

Standard Pillows: N/A Finish Req: N

Standard Cushions: High Resiliency 30 Standard Finish: BRUSHED BRASS
COM: 2.75 yards

Width: 26 Depth: 20 Height: 18

AH: - SH: - SD: - IW: -

Weight: 30 / 40 lbs Cube: 5.41

D	E	F	G	H	J	K _{COM}	L	M	N	O	P	Q	R	S	T	U	(# above U) *	S Nail	M Nail
1185	1197	1209	1221	1233	1245	1257	1269	1281	1293	1305	1317	1329	1341	1353	1365	1377	12 (Riser) + 1377 (U)	30	45

C-6403-26-2

LIBBY LANGDON FOR FAIRFIELD
Westway Right Arm Facing Chaise

Standard Pillows: N/A Finish Req: N

Standard Cushions: Endurance Standard Finish: Nickel
COM: 10.5 yards

Width: 33 Depth: 66 Height: 34.5

AH: 23.25 SH: 20 SD: 53.5 IW: 28.5

Weight: 87 / 97 lbs Cube: 43.48

D	E	F	G	H	J	K _{COM}	L	M	N	O	P	Q	R	S	T	U	(# above U) *	S Nail	M Nail
3795	3828	3861	3894	3927	3960	3993	4026	4059	4092	4125	4158	4191	4224	4257	4290	4323	33 (Riser) + 4323 (U)	90	105

C-6403-26-6

LIBBY LANGDON FOR FAIRFIELD
Westway Right Arm Facing Chaise

Standard Pillows: N/A Finish Req: N

Standard Cushions: Endurance Standard Finish: BRUSHED BRASS
COM: 10.5 yards

Width: 33 Depth: 66 Height: 34.5

AH: 23.25 SH: 20 SD: 53.5 IW: 28.5

Weight: 87 / 97 lbs Cube: 43.48

D	E	F	G	H	J	K _{COM}	L	M	N	O	P	Q	R	S	T	U	(# above U) *	S Nail	M Nail
3795	3828	3861	3894	3927	3960	3993	4026	4059	4092	4125	4158	4191	4224	4257	4290	4323	33 (Riser) + 4323 (U)	90	105

C-6403-27-2

LIBBY LANGDON FOR FAIRFIELD
Westway Left Arm Facing Chaise

Standard Pillows: N/A Finish Req: N

Standard Cushions: Endurance Standard Finish: Nickel
COM: 10.5 yards

Width: 33 Depth: 66 Height: 34.5

AH: 23.25 SH: 20 SD: 53.5 IW: 28.5

Weight: 87 / 97 lbs Cube: 43.48

D	E	F	G	H	J	K _{COM}	L	M	N	O	P	Q	R	S	T	U	(# above U) *	S Nail	M Nail
3795	3828	3861	3894	3927	3960	3993	4026	4059	4092	4125	4158	4191	4224	4257	4290	4323	33 (Riser) + 4323 (U)	90	105

C-6403-27-6

LIBBY LANGDON FOR FAIRFIELD
Westway Left Arm Facing Chaise

Standard Pillows: N/A Finish Req: N

Standard Cushions: Endurance Standard Finish: BRUSHED BRASS
COM: 10.5 yards

Width: 33 Depth: 66 Height: 34.5

AH: 23.25 SH: 20 SD: 53.5 IW: 28.5

Weight: 87 / 97 lbs Cube: 43.48

D	E	F	G	H	J	K _{COM}	L	M	N	O	P	Q	R	S	T	U	(# above U) *	S Nail	M Nail
3795	3828	3861	3894	3927	3960	3993	4026	4059	4092	4125	4158	4191	4224	4257	4290	4323	33 (Riser) + 4323 (U)	90	105

C-6403-29-2

LIBBY LANGDON FOR FAIRFIELD
Westway Corner Chair

Standard Pillows: N/A Finish Req: N

Standard Cushions: Endurance Standard Finish: Nickel
COM: 9 yards

Width: 36.5 Depth: 36.5 Height: 34.5

AH: - SH: 20 SD: 22 IW: 22

Weight: 65 / 75 lbs Cube: 26.59

D	E	F	G	H	J	K _{COM}	L	M	N	O	P	Q	R	S	T	U	(# above U) *	S Nail	M Nail
2955	2982	3009	3036	3063	3090	3117	3144	3171	3198	3225	3252	3279	3306	3333	3360	3387	27 (Riser) + 3387 (U)	45	60

C-6403-29-6

LIBBY LANGDON FOR FAIRFIELD
Westway Corner Chair

Standard Pillows: N/A Finish Req: N

Standard Cushions: Endurance Standard Finish: BRUSHED BRASS
COM: 9 yards

Width: 36.5 Depth: 36.5 Height: 34.5

AH: - SH: 20 SD: 22 IW: 22

Weight: 65 / 75 lbs Cube: 26.59

D	E	F	G	H	J	K _{COM}	L	M	N	O	P	Q	R	S	T	U	(# above U) *	S Nail	M Nail
2955	2982	3009	3036	3063	3090	3117	3144	3171	3198	3225	3252	3279	3306	3333	3360	3387	27 (Riser) + 3387 (U)	45	60

UPHOLSTERY

C-6403-51-2

LIBBY LANGDON FOR FAIRFIELD
Westway Right Arm Facing Sofa

Standard Pillows: N/A Finish Req: N
Standard Cushions: Endurance Standard Finish: Nickel
COM: 12 yards

Width: 75.5 Depth: 36.5 Height: 34.5
AH: 23.25 SH: 20 SD: 22 IW: 70.5
Weight: 120 / 130 lbs Cube: 55.01

D	E	F	G	H	J	K ^{COM}	L	M	N	O	P	Q	R	S	T	U	(# above U) *	S Nail	M Nail
4275	4311	4347	4383	4419	4455	4491	4527	4563	4599	4635	4671	4707	4743	4779	4815	4851	36 (Riser) + 4851 (U)	105	120

C-6403-51-6

LIBBY LANGDON FOR FAIRFIELD
Westway Right Arm Facing Sofa

Standard Pillows: N/A Finish Req: N
Standard Cushions: Endurance Standard Finish: BRUSHED BRASS
COM: 12 yards

Width: 75.5 Depth: 36.5 Height: 34.5
AH: 23.25 SH: 20 SD: 22 IW: 70.5
Weight: 120 / 130 lbs Cube: 55.01

D	E	F	G	H	J	K ^{COM}	L	M	N	O	P	Q	R	S	T	U	(# above U) *	S Nail	M Nail
4275	4311	4347	4383	4419	4455	4491	4527	4563	4599	4635	4671	4707	4743	4779	4815	4851	36 (Riser) + 4851 (U)	105	120

C-6403-52-2

LIBBY LANGDON FOR FAIRFIELD
Westway Left Arm Facing Sofa

Standard Pillows: N/A Finish Req: N
Standard Cushions: Endurance Standard Finish: Nickel
COM: 12 yards

Width: 75.5 Depth: 36.5 Height: 34.5
AH: 23.25 SH: 20 SD: 22 IW: 70.5
Weight: 120 / 130 lbs Cube: 55.01

D	E	F	G	H	J	K ^{COM}	L	M	N	O	P	Q	R	S	T	U	(# above U) *	S Nail	M Nail
4275	4311	4347	4383	4419	4455	4491	4527	4563	4599	4635	4671	4707	4743	4779	4815	4851	36 (Riser) + 4851 (U)	105	120

C-6403-52-6

LIBBY LANGDON FOR FAIRFIELD
Westway Left Arm Facing Sofa

Standard Pillows: N/A Finish Req: N
Standard Cushions: Endurance Standard Finish: BRUSHED BRASS
COM: 12 yards

Width: 75.5 Depth: 36.5 Height: 34.5
AH: 23.25 SH: 20 SD: 22 IW: 70.5
Weight: 120 / 130 lbs Cube: 55.01

D	E	F	G	H	J	K ^{COM}	L	M	N	O	P	Q	R	S	T	U	(# above U) *	S Nail	M Nail
4275	4311	4347	4383	4419	4455	4491	4527	4563	4599	4635	4671	4707	4743	4779	4815	4851	36 (Riser) + 4851 (U)	105	120

C-6403-53-2

LIBBY LANGDON FOR FAIRFIELD
Westway Right Arm Facing Corner Sofa

Standard Pillows: N/A Finish Req: N
Standard Cushions: Endurance Standard Finish: Nickel
COM: 16.25 yards

Width: 87 Depth: 36.5 Height: 34.5
AH: 23.5 SH: 20 SD: 22 IW: 69
Weight: 130 / 140 lbs Cube: 63.39

D	E	F	G	H	J	K ^{COM}	L	M	N	O	P	Q	R	S	T	U	(# above U) *	S Nail	M Nail
5175	5223	5271	5319	5367	5415	5463	5511	5559	5607	5655	5703	5751	5799	5847	5895	5943	48 (Riser) + 5943 (U)	105	120

C-6403-53-6

LIBBY LANGDON FOR FAIRFIELD
Westway Right Arm Facing Corner Sofa

Standard Pillows: N/A Finish Req: N
Standard Cushions: Endurance Standard Finish: BRUSHED BRASS
COM: 16.25 yards

Width: 87 Depth: 36.5 Height: 34.5
AH: 23.5 SH: 20 SD: 22 IW: 69
Weight: 130 / 140 lbs Cube: 63.39

D	E	F	G	H	J	K ^{COM}	L	M	N	O	P	Q	R	S	T	U	(# above U) *	S Nail	M Nail
5175	5223	5271	5319	5367	5415	5463	5511	5559	5607	5655	5703	5751	5799	5847	5895	5943	48 (Riser) + 5943 (U)	105	120

C-6403-54-2

LIBBY LANGDON FOR FAIRFIELD
Westway Left Arm Facing Corner Sofa

Standard Pillows: N/A Finish Req: N
Standard Cushions: Endurance Standard Finish: Nickel
COM: 16.25 yards

Width: 87 Depth: 36.5 Height: 34.5
AH: 23.5 SH: 20 SD: 22 IW: 69
Weight: 130 / 140 lbs Cube: 63.39

D	E	F	G	H	J	K ^{COM}	L	M	N	O	P	Q	R	S	T	U	(# above U) *	S Nail	M Nail
5175	5223	5271	5319	5367	5415	5463	5511	5559	5607	5655	5703	5751	5799	5847	5895	5943	48 (Riser) + 5943 (U)	105	120

UPHOLSTERY

C-6403-54-6

LIBBY LANGDON FOR FAIRFIELD
Westway Left Arm Facing Corner Sofa

Standard Pillows: N/A Finish Req: N
Standard Cushions: Endurance Standard Finish: BRUSHED BRASS
COM: 16.25 yards

Width: 87 Depth: 36.5 Height: 34.5
AH: 23.5 SH: 20 SD: 22 IW: 69
Weight: 130 / 140 lbs Cube: 63.39

D	E	F	G	H	J	K _{COM}	L	M	N	O	P	Q	R	S	T	U	(# above U) *	S Nail	M Nail
5175	5223	5271	5319	5367	5415	5463	5511	5559	5607	5655	5703	5751	5799	5847	5895	5943	48 (Riser) + 5943 (U)	105	120

C-6403-58-2

LIBBY LANGDON FOR FAIRFIELD
Westway Armless Sofa

Standard Pillows: N/A Finish Req: N
Standard Cushions: Endurance Standard Finish: Nickel
COM: 10.5 yards

Width: 70.5 Depth: 36.5 Height: 34.5
AH: - SH: 20 SD: 22 IW: 70.5
Weight: 103 / 113 lbs Cube: 51.37

D	E	F	G	H	J	K _{COM}	L	M	N	O	P	Q	R	S	T	U	(# above U) *	S Nail	M Nail
4125	4158	4191	4224	4257	4290	4323	4356	4389	4422	4455	4488	4521	4554	4587	4620	4653	33 (Riser) + 4653 (U)	75	90

C-6403-58-6

LIBBY LANGDON FOR FAIRFIELD
Westway Armless Sofa

Standard Pillows: N/A Finish Req: N
Standard Cushions: Endurance Standard Finish: BRUSHED BRASS
COM: 10.5 yards

Width: 70.5 Depth: 36.5 Height: 34.5
AH: - SH: 20 SD: 22 IW: 70.5
Weight: 103 / 113 lbs Cube: 51.37

D	E	F	G	H	J	K _{COM}	L	M	N	O	P	Q	R	S	T	U	(# above U) *	S Nail	M Nail
4125	4158	4191	4224	4257	4290	4323	4356	4389	4422	4455	4488	4521	4554	4587	4620	4653	33 (Riser) + 4653 (U)	75	90

C-6403-70-2

LIBBY LANGDON FOR FAIRFIELD
Westway Loveseat

Standard Pillows: N/A Finish Req: N
Standard Cushions: Endurance Standard Finish: Nickel
COM: 10.75 yards

Width: 57 Depth: 36.5 Height: 34.5
AH: 23.5 SH: 20 SD: 22 IW: 47
Weight: 100 / 110 lbs Cube: 41.53

D	E	F	G	H	J	K _{COM}	L	M	N	O	P	Q	R	S	T	U	(# above U) *	S Nail	M Nail
3885	3918	3951	3984	4017	4050	4083	4116	4149	4182	4215	4248	4281	4314	4347	4380	4413	33 (Riser) + 4413 (U)	135	150

C-6403-70-6

LIBBY LANGDON FOR FAIRFIELD
Westway Loveseat

Standard Pillows: N/A Finish Req: N
Standard Cushions: Endurance Standard Finish: BRUSHED BRASS
COM: 10.75 yards

Width: 57 Depth: 36.5 Height: 34.5
AH: 23.5 SH: 20 SD: 22 IW: 47
Weight: 100 / 110 lbs Cube: 41.53

D	E	F	G	H	J	K _{COM}	L	M	N	O	P	Q	R	S	T	U	(# above U) *	S Nail	M Nail
3885	3918	3951	3984	4017	4050	4083	4116	4149	4182	4215	4248	4281	4314	4347	4380	4413	33 (Riser) + 4413 (U)	135	150

C-6403-71-2

LIBBY LANGDON FOR FAIRFIELD
Westway Right Arm Loveseat

Standard Pillows: N/A Finish Req: N
Standard Cushions: Endurance Standard Finish: Nickel
COM: 7.75 yards

Width: 52 Depth: 36.5 Height: 34.5
AH: 23.5 SH: 20 SD: 22 IW: 47
Weight: 94 / 104 lbs Cube: 37.89

D	E	F	G	H	J	K _{COM}	L	M	N	O	P	Q	R	S	T	U	(# above U) *	S Nail	M Nail
3375	3402	3429	3456	3483	3510	3537	3564	3591	3618	3645	3672	3699	3726	3753	3780	3807	27 (Riser) + 3807 (U)	90	105

C-6403-71-6

LIBBY LANGDON FOR FAIRFIELD
Westway Right Arm Loveseat

Standard Pillows: N/A Finish Req: N
Standard Cushions: Endurance Standard Finish: BRUSHED BRASS
COM: 7.75 yards

Width: 52 Depth: 36.5 Height: 34.5
AH: 23.5 SH: 20 SD: 22 IW: 47
Weight: 94 / 104 lbs Cube: 37.89

D	E	F	G	H	J	K _{COM}	L	M	N	O	P	Q	R	S	T	U	(# above U) *	S Nail	M Nail
3375	3402	3429	3456	3483	3510	3537	3564	3591	3618	3645	3672	3699	3726	3753	3780	3807	27 (Riser) + 3807 (U)	90	105

UPHOLSTERY

C-6403-72-2

LIBBY LANGDON FOR FAIRFIELD
Westway Left Arm Loveseat

Standard Pillows: N/A Finish Req: N
Standard Cushions: Endurance Standard Finish: Nickel
COM: 7.75 yards

Width: 52 Depth: 36.5 Height: 34.5
AH: 23.5 SH: 20 SD: 22 IW: 47
Weight: 94 / 104 lbs Cube: 37.89

D	E	F	G	H	J	K _{COM}	L	M	N	O	P	Q	R	S	T	U	(# above U) *	S Nail	M Nail
3375	3402	3429	3456	3483	3510	3537	3564	3591	3618	3645	3672	3699	3726	3753	3780	3807	27 (Riser) + 3807 (U)	90	105

C-6403-72-6

LIBBY LANGDON FOR FAIRFIELD
Westway Left Arm Loveseat

Standard Pillows: N/A Finish Req: N
Standard Cushions: Endurance Standard Finish: BRUSHED BRASS
COM: 7.75 yards

Width: 52 Depth: 36.5 Height: 34.5
AH: 23.5 SH: 20 SD: 22 IW: 47
Weight: 94 / 104 lbs Cube: 37.89

D	E	F	G	H	J	K _{COM}	L	M	N	O	P	Q	R	S	T	U	(# above U) *	S Nail	M Nail
3375	3402	3429	3456	3483	3510	3537	3564	3591	3618	3645	3672	3699	3726	3753	3780	3807	27 (Riser) + 3807 (U)	90	105

C-6403-78-2

LIBBY LANGDON FOR FAIRFIELD
Westway Armless Chair

Standard Pillows: N/A Finish Req: N
Standard Cushions: Endurance Standard Finish: Nickel
COM: 4.5 yards

Width: 23.5 Depth: 36.5 Height: 34.5
AH: - SH: 20 SD: 22 IW: 23.5
Weight: 51 / 61 lbs Cube: 17.12

D	E	F	G	H	J	K _{COM}	L	M	N	O	P	Q	R	S	T	U	(# above U) *	S Nail	M Nail
2220	2235	2250	2265	2280	2295	2310	2325	2340	2355	2370	2385	2400	2415	2430	2445	2460	15 (Riser) + 2460 (U)	45	60

C-6403-78-6

LIBBY LANGDON FOR FAIRFIELD
Westway Armless Chair

Standard Pillows: N/A Finish Req: N
Standard Cushions: Endurance Standard Finish: BRUSHED BRASS
COM: 4.5 yards

Width: 23.5 Depth: 36.5 Height: 34.5
AH: - SH: 20 SD: 22 IW: 23.5
Weight: 51 / 61 lbs Cube: 17.12

D	E	F	G	H	J	K _{COM}	L	M	N	O	P	Q	R	S	T	U	(# above U) *	S Nail	M Nail
2220	2235	2250	2265	2280	2295	2310	2325	2340	2355	2370	2385	2400	2415	2430	2445	2460	15 (Riser) + 2460 (U)	45	60

C-6403-79-2

LIBBY LANGDON FOR FAIRFIELD
Westway Armless Loveseat

Standard Pillows: N/A Finish Req: N
Standard Cushions: Endurance Standard Finish: Nickel
COM: 7.5 yards

Width: 47 Depth: 36.5 Height: 34.5
AH: - SH: 20 SD: 22 IW: 47
Weight: 88 / 98 lbs Cube: 34.25

D	E	F	G	H	J	K _{COM}	L	M	N	O	P	Q	R	S	T	U	(# above U) *	S Nail	M Nail
3150	3171	3192	3213	3234	3255	3276	3297	3318	3339	3360	3381	3402	3423	3444	3465	3486	21 (Riser) + 3486 (U)	60	75

C-6403-79-6

LIBBY LANGDON FOR FAIRFIELD
Westway Armless Loveseat

Standard Pillows: N/A Finish Req: N
Standard Cushions: Endurance Standard Finish: BRUSHED BRASS
COM: 7.5 yards

Width: 47 Depth: 36.5 Height: 34.5
AH: - SH: 20 SD: 22 IW: 47
Weight: 88 / 98 lbs Cube: 34.25

D	E	F	G	H	J	K _{COM}	L	M	N	O	P	Q	R	S	T	U	(# above U) *	S Nail	M Nail
3150	3171	3192	3213	3234	3255	3276	3297	3318	3339	3360	3381	3402	3423	3444	3465	3486	21 (Riser) + 3486 (U)	60	75

C-6408-01

LIBBY LANGDON FOR FAIRFIELD
Percy Wing Chair

Standard Pillows: (1) Kidney Finish Req: Y
Standard Cushions: Endurance Standard Finish: N/A
COM: 5.5 yards

Width: 28 Depth: 33.5 Height: 35.5
AH: 23.25 SH: 19.5 SD: 23 IW: 21.5
Weight: 47 / 60 lbs Cube: 23.89

D	E	F	G	H	J	K _{COM}	L	M	N	O	P	Q	R	S	T	U	(# above U) *	S Nail	M Nail
2550	2568	2586	2604	2622	2640	2658	2676	2694	2712	2730	2748	2766	2784	2802	2820	2838	18 (Riser) + 2838 (U)	Std.	15

UPHOLSTERY

C-6409-01

LIBBY LANGDON FOR FAIRFIELD
Trident Lounge Chair

Standard Pillows: N/A Finish Req: Y
Standard Cushions: Endurance Standard Finish: N/A
COM: 5.5 yards

Width: 29.5 Depth: 36.5 Height: 36.5
AH: 25 SH: 20 SD: 24 IW: 22
Weight: 45 / 58 lbs Cube: 23.89

D	E	F	G	H	J	K _{COM}	L	M	N	O	P	Q	R	S	T	U	(# above U) *	S Nail	M Nail
2475	2493	2511	2529	2547	2565	2583	2601	2619	2637	2655	2673	2691	2709	2727	2745	2763	18 (Riser) + 2763 (U)	90	N/A

C-6409-31-2

LIBBY LANGDON FOR FAIRFIELD
Trident Swivel Chair

Standard Pillows: N/A Finish Req: N
Standard Cushions: Endurance Standard Finish: Nickel
COM: 5.5 yards

Width: 29.5 Depth: 36.5 Height: 36.5
AH: 25 SH: 20 SD: 24 IW: 22
Weight: 45 / 58 lbs Cube: 23.89

D	E	F	G	H	J	K _{COM}	L	M	N	O	P	Q	R	S	T	U	(# above U) *	S Nail	M Nail
2700	2718	2736	2754	2772	2790	2808	2826	2844	2862	2880	2898	2916	2934	2952	2970	2988	18 (Riser) + 2988 (U)	90	N/A

C-6409-31-7

LIBBY LANGDON FOR FAIRFIELD
Trident Swivel Chair

Standard Pillows: N/A Finish Req: N
Standard Cushions: Endurance Standard Finish: Bright Brass
COM: 5.5 yards

Width: 29.5 Depth: 36.5 Height: 36.5
AH: 25 SH: 20 SD: 24 IW: 22
Weight: 45 / 58 lbs Cube: 23.89

D	E	F	G	H	J	K _{COM}	L	M	N	O	P	Q	R	S	T	U	(# above U) *	S Nail	M Nail
2700	2718	2736	2754	2772	2790	2808	2826	2844	2862	2880	2898	2916	2934	2952	2970	2988	18 (Riser) + 2988 (U)	90	N/A

C-6469-01

LIBBY LANGDON FOR FAIRFIELD
Halsey Lounge Chair

Standard Pillows: N/A Finish Req: Y
Standard Cushions: Endurance Standard Finish: N/A
COM: 7.75 yards
Chair version of the 469C-MR & 469C-PR Recliner.

Width: 25.5 Depth: 36.5 Height: 39.25
AH: 25.5 SH: 20 SD: 20 IW: 21
Weight: 73 / 73 lbs Cube: 21.14

D	E	F	G	H	J	K _{COM}	L	M	N	O	P	Q	R	S	T	U	(# above U) *	S Nail	M Nail
2745	2766	2787	2808	2829	2850	2871	2892	2913	2934	2955	2976	2997	3018	3039	3060	3081	21 (Riser) + 3081 (U)	75	90

C-6469-20

LIBBY LANGDON FOR FAIRFIELD
Halsey Ottoman

Standard Pillows: N/A Finish Req: Y
Standard Cushions: High Resiliency 30 Standard Finish: N/A
COM: 2.25 yards

Width: 22.25 Depth: 19.25 Height: 18.25
AH: - SH: - SD: - IW: -
Weight: 12 / 19 lbs Cube: 4.52

D	E	F	G	H	J	K _{COM}	L	M	N	O	P	Q	R	S	T	U	(# above U) *	S Nail	M Nail
1125	1134	1143	1152	1161	1170	1179	1188	1197	1206	1215	1224	1233	1242	1251	1260	1269	9 (Riser) + 1269 (U)	30	45

C-7400-01

Hanna Occasional Chair

Standard Pillows: N/A Finish Req: Y
Standard Cushions: Endurance Standard Finish: N/A
COM: 3.5 yards

Width: 26 Depth: 26.5 Height: 34
AH: 24 SH: 20.5 SD: 20.5 IW: 20
Weight: 35 / 48 lbs Cube: 21.65

D	E	F	G	H	J	K _{COM}	L	M	N	O	P	Q	R	S	T	U	(# above U) *	S Nail	M Nail
1980	1992	2004	2016	2028	2040	2052	2064	2076	2088	2100	2112	2124	2136	2148	2160	2172	12 (Riser) + 2172 (U)	45	N/A

C-7412-E1

Evanston EasyClean Lounge Chair

Standard Pillows: N/A Finish Req: Y
Standard Cushions: Support Plus Standard Finish: N/A
COM: 6 yards
Features an EasyClean Seat.

Width: 32.5 Depth: 33 Height: 33
AH: 26.5 SH: 19 SD: 18.5 IW: 20.5
Weight: 45 / 59 lbs Cube: 29.69

D	E	F	G	H	J	K _{COM}	L	M	N	O	P	Q	R	S	T	U	(# above U) *	S Nail	M Nail
2250	2268	2286	2304	2322	2340	2358	2376	2394	2412	2430	2448	2466	2484	2502	2520	2538	18 (Riser) + 2538 (U)	45	60

UPHOLSTERY

C-7412-01

Standard Pillows: N/A **Finish Req:** Y
Standard Cushions: Endurance **Standard Finish:** N/A
COM: 5.25 yards

Evanston Lounge Chair

Width: 32.5 **Depth:** 34.5 **Height:** 32.5
AH: 27 **SH:** 20 **SD:** 19 **IW:** 21.5
Weight: 55 / 69 lbs **Cube:** 29.69

D	E	F	G	H	J	K _{COM}	L	M	N	O	P	Q	R	S	T	U	(# above U) *	S Nail	M Nail
2250	2268	2286	2304	2322	2340	2358	2376	2394	2412	2430	2448	2466	2484	2502	2520	2538	18 (Riser) + 2538 (U)	45	60

C-7413-E1

Standard Pillows: N/A **Finish Req:** Y
Standard Cushions: High Resiliency 35 **Standard Finish:** N/A
COM: 7.25 yards
 Features an EasyClean Seat.

Collins EasyClean Wing Chair

Width: 31 **Depth:** 33.5 **Height:** 41.5
AH: 25.5 **SH:** 19.5 **SD:** 20 **IW:** 23.5
Weight: 65 / 75 lbs **Cube:** 34.38

D	E	F	G	H	J	K _{COM}	L	M	N	O	P	Q	R	S	T	U	(# above U) *	S Nail	M Nail
2475	2496	2517	2538	2559	2580	2601	2622	2643	2664	2685	2706	2727	2748	2769	2790	2811	21 (Riser) + 2811 (U)	75	90

C-7418-A2

Standard Pillows: N/A **Finish Req:** Y
Standard Cushions: Endurance **Standard Finish:** N/A
COM: 5 yards

Cloe Lounge Chair

Width: 30 **Depth:** 30.5 **Height:** 31.5
AH: 28.5 **SH:** 19.5 **SD:** 19.5 **IW:** 20
Weight: 90 / 103 lbs **Cube:** 23.89

D	E	F	G	H	J	K _{COM}	L	M	N	O	P	Q	R	S	T	U	(# above U) *	S Nail	M Nail
2166	2181	2196	2211	2226	2241	2256	2271	2286	2301	2316	2331	2346	2361	2376	2391	2406	15 (Riser) + 2406 (U)	N/A	N/A

C-7418-01

Standard Pillows: N/A **Finish Req:** Y
Standard Cushions: Endurance **Standard Finish:** N/A
COM: 5 yards

Cloe Lounge Chair

Width: 30 **Depth:** 30.5 **Height:** 31.5
AH: 28.5 **SH:** 19.5 **SD:** 19.5 **IW:** 20
Weight: 90 / 103 lbs **Cube:** 23.89

D	E	F	G	H	J	K _{COM}	L	M	N	O	P	Q	R	S	T	U	(# above U) *	S Nail	M Nail
2130	2145	2160	2175	2190	2205	2220	2235	2250	2265	2280	2295	2310	2325	2340	2355	2370	15 (Riser) + 2370 (U)	N/A	N/A

C-7418-70

Standard Pillows: N/A **Finish Req:** Y
Standard Cushions: Endurance **Standard Finish:** N/A
COM: 8.25 yards

Cloe Loveseat

Width: 58 **Depth:** 27.5 **Height:** 31
AH: 28.5 **SH:** 19.5 **SD:** 20 **IW:** 48
Weight: 100 / 130 lbs **Cube:** 55.51

D	E	F	G	H	J	K _{COM}	L	M	N	O	P	Q	R	S	T	U	(# above U) *	S Nail	M Nail
2925	2949	2973	2997	3021	3045	3069	3093	3117	3141	3165	3189	3213	3237	3261	3285	3309	24 (Riser) + 3309 (U)	N/A	N/A

C-7421-A8

Standard Pillows: N/A **Finish Req:** N
Standard Cushions: Endurance **Standard Finish:** N/A
COM: 5.5 yards

Eathen Swivel Chair

Width: 31 **Depth:** 33.5 **Height:** 34
AH: 25 **SH:** 20 **SD:** 20 **IW:** 22
Weight: 65 / 78 lbs **Cube:** 23.89

D	E	F	G	H	J	K _{COM}	L	M	N	O	P	Q	R	S	T	U	(# above U) *	S Nail	M Nail
2505	2520	2535	2550	2565	2580	2595	2610	2625	2640	2655	2670	2685	2700	2715	2730	2745	15 (Riser) + 2745 (U)	75	90

C-7421-T1

Standard Pillows: N/A **Finish Req:** Y
Standard Cushions: Endurance **Standard Finish:** N/A
COM: 5.5 yards
 Features a Folding Tablet w/Black High Pressure Laminate (Left Side Facing)

Eathen Lounge Chair with Folding Tablet

Width: 31 **Depth:** 33.5 **Height:** 34
AH: 25 **SH:** 20 **SD:** 20 **IW:** 22
Weight: 65 / 79 lbs **Cube:** 29.69

D	E	F	G	H	J	K _{COM}	L	M	N	O	P	Q	R	S	T	U	(# above U) *	S Nail	M Nail
2865	2880	2895	2910	2925	2940	2955	2970	2985	3000	3015	3030	3045	3060	3075	3090	3105	15 (Riser) + 3105 (U)	75	90

UPHOLSTERY

C-7421-01

Standard Pillows: N/A **Finish Req:** Y
Standard Cushions: Endurance **Standard Finish:** N/A
COM: 5.5 yards

Eathen Lounge Chair

Width: 31 **Depth:** 33.5 **Height:** 34
AH: 25 **SH:** 20 **SD:** 20 **IW:** 22
Weight: 65 / 78 lbs **Cube:** 23.89

D	E	F	G	H	J	K _{COM}	L	M	N	O	P	Q	R	S	T	U	(# above U) *	S Nail	M Nail
2175	2190	2205	2220	2235	2250	2265	2280	2295	2310	2325	2340	2355	2370	2385	2400	2415	15 (Riser) + 2415 (U)	75	90

C-7433-A2

Standard Pillows: N/A **Finish Req:** Y
Standard Cushions: Endurance **Standard Finish:** N/A
COM: 6.25 yards

Craven Lounge Chair

Width: 31 **Depth:** 32 **Height:** 35
AH: 24.5 **SH:** 19 **SD:** 20.5 **IW:** 23
Weight: 65 / 79 lbs **Cube:** 29.69

D	E	F	G	H	J	K _{COM}	L	M	N	O	P	Q	R	S	T	U	(# above U) *	S Nail	M Nail
2316	2334	2352	2370	2388	2406	2424	2442	2460	2478	2496	2514	2532	2550	2568	2586	2604	18 (Riser) + 2604 (U)	45	60

C-7433-E1

Standard Pillows: N/A **Finish Req:** Y
Standard Cushions: High Resiliency 30 **Standard Finish:** N/A
COM: 6 yards
Features an EasyClean Seat

Craven EasyClean Lounge Chair

Width: 31 **Depth:** 32 **Height:** 35
AH: 24 **SH:** 19 **SD:** 21 **IW:** 23
Weight: 65 / 79 lbs **Cube:** 29.69

D	E	F	G	H	J	K _{COM}	L	M	N	O	P	Q	R	S	T	U	(# above U) *	S Nail	M Nail
2235	2253	2271	2289	2307	2325	2343	2361	2379	2397	2415	2433	2451	2469	2487	2505	2523	18 (Riser) + 2523 (U)	45	60

C-7433-E2

Standard Pillows: N/A **Finish Req:** Y
Standard Cushions: High Resiliency 30 **Standard Finish:** N/A
COM: 6 yards

Craven EasyClean Lounge Chair with Front Casters

Width: 31 **Depth:** 32 **Height:** 35
AH: 24 **SH:** 19 **SD:** 21 **IW:** 23
Weight: 65 / 65 lbs **Cube:** 20.09

D	E	F	G	H	J	K _{COM}	L	M	N	O	P	Q	R	S	T	U	(# above U) *	S Nail	M Nail
2271	2289	2307	2325	2343	2361	2379	2397	2415	2433	2451	2469	2487	2505	2523	2541	2559	18 (Riser) + 2559 (U)	45	60

C-7433-T1

Standard Pillows: N/A **Finish Req:** Y
Standard Cushions: Endurance **Standard Finish:** N/A
COM: 6.25 yards
Features a Folding Tablet w/Black High Pressure Laminate (LSF). Tablet Ht: 25"

Craven Lounge Chair with Folding Tablet

Width: 32.5 **Depth:** 32.5 **Height:** 35
AH: 24.5 **SH:** 19 **SD:** 20 **IW:** 23
Weight: 75 / 89 lbs **Cube:** 29.69

D	E	F	G	H	J	K _{COM}	L	M	N	O	P	Q	R	S	T	U	(# above U) *	S Nail	M Nail
3090	3108	3126	3144	3162	3180	3198	3216	3234	3252	3270	3288	3306	3324	3342	3360	3378	18 (Riser) + 3378 (U)	45	60

C-7433-T2

Standard Pillows: N/A **Finish Req:** Y
Standard Cushions: Endurance **Standard Finish:** N/A
COM: 6.25 yards
Features a Folding Tablet w/Black High Pressure Laminate (LSF). Tablet Ht: 25"

Craven Lounge Chair with Folding Tablet & Front Casters

Width: 32.5 **Depth:** 32.5 **Height:** 35
AH: 24.5 **SH:** 19 **SD:** 20 **IW:** 23
Weight: 75 / 89 lbs **Cube:** 29.69

D	E	F	G	H	J	K _{COM}	L	M	N	O	P	Q	R	S	T	U	(# above U) *	S Nail	M Nail
3126	3144	3162	3180	3198	3216	3234	3252	3270	3288	3306	3324	3342	3360	3378	3396	3414	18 (Riser) + 3414 (U)	45	60

C-7433-T5

Standard Pillows: N/A **Finish Req:** Y
Standard Cushions: Endurance **Standard Finish:** N/A
COM: 11.5 yards
Tablet Ht: 26"

Craven Sofa with Folding Tablet

Width: 76.5 **Depth:** 32 **Height:** 35
AH: 24.5 **SH:** 19 **SD:** 20.5 **IW:** 69
Weight: 98 / 98 lbs **Cube:** 49.58

D	E	F	G	H	J	K _{COM}	L	M	N	O	P	Q	R	S	T	U	(# above U) *	S Nail	M Nail
4650	4686	4722	4758	4794	4830	4866	4902	4938	4974	5010	5046	5082	5118	5154	5190	5226	36 (Riser) + 5226 (U)	75	90

UPHOLSTERY

C-7433-T7

Craven Loveseat with Folding Tablet

Standard Pillows: N/A **Finish Req:** Y
Standard Cushions: Endurance **Standard Finish:** N/A
COM: 8.25 yards
 Features a Folding Tablet w/Black High Pressure Laminate (LSF). Tablet Ht: 26"

Width: 57 **Depth:** 31.5 **Height:** 35.5
AH: 25 **SH:** 19 **SD:** 20.5 **IW:** 49
Weight: 107 / 137 lbs **Cube:** 55.51

D	E	F	G	H	J	K COM	L	M	N	O	P	Q	R	S	T	U	(# above U) *	S Nail	M Nail
4350	4374	4398	4422	4446	4470	4494	4518	4542	4566	4590	4614	4638	4662	4686	4710	4734	24 (Riser) + 4734 (U)	60	75

C-7433-U1

Craven Lounge Chair with Left Side Facing Tablet and Charging Station

Weight: 65 / 65 lbs **Cube:** 20.09
Standard Pillows: N/A **Finish Req:** Y
Standard Cushions: Endurance **Standard Finish:** N/A
COM: 6.25 yards
 Features a Folding Tablet (LSF) & Charging Station (LSF, side)

Width: 31 **Depth:** 32 **Height:** 35
AH: 24.5 **SH:** 19 **SD:** 20 **IW:** 23

D	E	F	G	H	J	K COM	L	M	N	O	P	Q	R	S	T	U	(# above U) *	S Nail	M Nail
3240	3258	3276	3294	3312	3330	3348	3366	3384	3402	3420	3438	3456	3474	3492	3510	3528	18 (Riser) + 3528 (U)	45	60

C-7433-01

Craven Lounge Chair

Standard Pillows: N/A **Finish Req:** Y
Standard Cushions: Endurance **Standard Finish:** N/A
COM: 6.25 yards

Width: 31 **Depth:** 32 **Height:** 35
AH: 24.5 **SH:** 19 **SD:** 20.5 **IW:** 23
Weight: 65 / 79 lbs **Cube:** 29.69

D	E	F	G	H	J	K COM	L	M	N	O	P	Q	R	S	T	U	(# above U) *	S Nail	M Nail
2280	2298	2316	2334	2352	2370	2388	2406	2424	2442	2460	2478	2496	2514	2532	2550	2568	18 (Riser) + 2568 (U)	45	60

C-7433-50

Craven Sofa

Standard Pillows: N/A **Finish Req:** Y
Standard Cushions: Endurance **Standard Finish:** N/A
COM: 11.5 yards

Width: 76.5 **Depth:** 32 **Height:** 35
AH: 24.5 **SH:** 19 **SD:** 20.5 **IW:** 69
Weight: 98 / 98 lbs **Cube:** 49.58

D	E	F	G	H	J	K COM	L	M	N	O	P	Q	R	S	T	U	(# above U) *	S Nail	M Nail
3150	3186	3222	3258	3294	3330	3366	3402	3438	3474	3510	3546	3582	3618	3654	3690	3726	36 (Riser) + 3726 (U)	75	90

C-7433-70

Craven Loveseat

Standard Pillows: N/A **Finish Req:** Y
Standard Cushions: Endurance **Standard Finish:** N/A
COM: 8.25 yards

Width: 57 **Depth:** 31.5 **Height:** 35.5
AH: 25 **SH:** 19 **SD:** 20.5 **IW:** 49
Weight: 100 / 130 lbs **Cube:** 55.51

D	E	F	G	H	J	K COM	L	M	N	O	P	Q	R	S	T	U	(# above U) *	S Nail	M Nail
2775	2799	2823	2847	2871	2895	2919	2943	2967	2991	3015	3039	3063	3087	3111	3135	3159	24 (Riser) + 3159 (U)	60	75

C-7453-A2

Payton Lounge Chair with Front Casters, Cupholder

Standard Pillows: N/A **Finish Req:** Y
Standard Cushions: Endurance **Standard Finish:** N/A
COM: 7.5 yards
 Standard with Left Side Facing Cup Holder & Front Casters

Width: 36 **Depth:** 33 **Height:** 35
AH: 24.5 **SH:** 19 **SD:** 21 **IW:** 23
Weight: 65 / 79 lbs **Cube:** 29.69

D	E	F	G	H	J	K COM	L	M	N	O	P	Q	R	S	T	U	(# above U) *	S Nail	M Nail
2316	2340	2364	2388	2412	2436	2460	2484	2508	2532	2556	2580	2604	2628	2652	2676	2700	24 (Riser) + 2700 (U)	45	60

C-7453-T1

Payton Lounge Chair with Tablet

Standard Pillows: N/A **Finish Req:** Y
Standard Cushions: Endurance **Standard Finish:** N/A
COM: 7.5 yards
 Standard with a cupholder on top of the right side facing arm and a black high pressure laminate tablet on top of the left side facing arm. Tablet height is 26 inches.

Width: 36 **Depth:** 33 **Height:** 35
AH: 24.5 **SH:** 19 **SD:** 21 **IW:** 23
Weight: 65 / 79 lbs **Cube:** 29.69

D	E	F	G	H	J	K COM	L	M	N	O	P	Q	R	S	T	U	(# above U) *	S Nail	M Nail
3225	3249	3273	3297	3321	3345	3369	3393	3417	3441	3465	3489	3513	3537	3561	3585	3609	24 (Riser) + 3609 (U)	45	60

UPHOLSTERY

C-7453-T2

Payton Lounge Chair with Front Casters, Cupholder, Tablet

Width: 36 Depth: 33 Height: 35
 AH: 24.5 SH: 19 SD: 21 IW: 23
 Weight: 72 / 72 lbs Cube: 24.06

Standard Pillows: N/A Finish Req: Y
 Standard Cushions: Endurance Standard Finish: N/A
 COM: 7.5 yards
 Standard with front casters and a cupholder on top of the right side facing arm. Left side facing arm is standard with a black high pressure laminate tablet. Tablet height is 26 inches.

D	E	F	G	H	J	K _{COM}	L	M	N	O	P	Q	R	S	T	U	(# above U) *	S Nail	M Nail
3261	3285	3309	3333	3357	3381	3405	3429	3453	3477	3501	3525	3549	3573	3597	3621	3645	24 (Riser) + 3645 (U)	45	60

C-7453-U1

Payton Lounge Chair with Tablet, Charging Station, Cupholder

Width: 36 Depth: 33 Height: 35
 AH: 24.5 SH: 19 SD: 21 IW: 23
 Weight: 65 / 79 lbs Cube: 29.69

Standard Pillows: N/A Finish Req: Y
 Standard Cushions: Endurance Standard Finish: N/A
 COM: 7.5 yards
 Standard with a black, high pressure laminate tablet on top of the left side facing arm and a charging station on the left side arm panel. Tablet height is 26 inches. The top of the right side facing arm is standard with a cup holder.

D	E	F	G	H	J	K _{COM}	L	M	N	O	P	Q	R	S	T	U	(# above U) *	S Nail	M Nail
3450	3474	3498	3522	3546	3570	3594	3618	3642	3666	3690	3714	3738	3762	3786	3810	3834	24 (Riser) + 3834 (U)	45	N/A

C-7453-U2

Payton Lounge Chair with Casters, Tablet, Charging Station, Cupholder

Width: 36 Depth: 33 Height: 35
 AH: 24.5 SH: 19 SD: 21 IW: 23

Weight: 65 / 79 lbs Cube: 29.69
 Standard Pillows: N/A Finish Req: Y
 Standard Cushions: Endurance Standard Finish: N/A
 COM: 7.5 yards
 Standard with front casters and a black, high pressure laminate tablet on top of left side facing arm. Tablet height is 26 inches. The left side arm panel features a standard charging station. The top of the right side facing arm is standard with cupholder

D	E	F	G	H	J	K _{COM}	L	M	N	O	P	Q	R	S	T	U	(# above U) *	S Nail	M Nail
3486	3510	3534	3558	3582	3606	3630	3654	3678	3702	3726	3750	3774	3798	3822	3846	3870	24 (Riser) + 3870 (U)	45	N/A

C-7453-01

Payton Lounge Chair with Cupholder

Width: 36 Depth: 33 Height: 35
 AH: 24.5 SH: 19 SD: 21 IW: 23
 Weight: 65 / 79 lbs Cube: 29.69

Standard Pillows: N/A Finish Req: Y
 Standard Cushions: Endurance Standard Finish: N/A
 COM: 7.5 yards
 Standard with a cupholder on top of the left side facing arm.

D	E	F	G	H	J	K _{COM}	L	M	N	O	P	Q	R	S	T	U	(# above U) *	S Nail	M Nail
2280	2304	2328	2352	2376	2400	2424	2448	2472	2496	2520	2544	2568	2592	2616	2640	2664	24 (Riser) + 2664 (U)	45	60

C-7454-A2

Payton Lounge Chair with Casters, Cupholder, UV-C

Width: 36 Depth: 33 Height: 35
 AH: 24.5 SH: 19 SD: 21 IW: 23
 Weight: 65 / 79 lbs Cube: 29.69

Standard Pillows: N/A Finish Req: Y
 Standard Cushions: Endurance Standard Finish: N/A
 COM: 7.5 yards
 Standard with front casters and a cupholder on top of the left side facing arm. Right side facing arm is standard with a UV-C system.

D	E	F	G	H	J	K _{COM}	L	M	N	O	P	Q	R	S	T	U	(# above U) *	S Nail	M Nail
2511	2535	2559	2583	2607	2631	2655	2679	2703	2727	2751	2775	2799	2823	2847	2871	2895	24 (Riser) + 2895 (U)	45	60

C-7454-T1

Payton Lounge Chair with Tablet, UV-C

Width: 36 Depth: 33 Height: 35
 AH: 24.5 SH: 19 SD: 21 IW: 23
 Weight: 65 / 79 lbs Cube: 29.69

Standard Pillows: N/A Finish Req: Y
 Standard Cushions: Endurance Standard Finish: N/A
 COM: 7.5 yards
 Standard with a black, high pressure laminate folding tablet on top of the left side facing arm. Tablet height is 26 inches. Right side facing arm is standard with a UV-C system.

D	E	F	G	H	J	K _{COM}	L	M	N	O	P	Q	R	S	T	U	(# above U) *	S Nail	M Nail
3330	3354	3378	3402	3426	3450	3474	3498	3522	3546	3570	3594	3618	3642	3666	3690	3714	24 (Riser) + 3714 (U)	45	60

C-7454-T2

Payton Lounge Chair with Casters, Tablet, UV-C

Width: 36 Depth: 33 Height: 35
 AH: 24.5 SH: 19 SD: 21 IW: 23
 Weight: 72 / 72 lbs Cube: 24.06

Standard Pillows: N/A Finish Req: Y
 Standard Cushions: Endurance Standard Finish: N/A
 COM: 7.5 yards
 Standard with front casters, and a black, high pressure laminate folding tablet on top of the left side facing arm. Tablet height is 26 inches. Right side facing arm is standard with a UV-C system.

D	E	F	G	H	J	K _{COM}	L	M	N	O	P	Q	R	S	T	U	(# above U) *	S Nail	M Nail
3366	3390	3414	3438	3462	3486	3510	3534	3558	3582	3606	3630	3654	3678	3702	3726	3750	24 (Riser) + 3750 (U)	45	60

UPHOLSTERY

C-7454-V1

Payton Lounge Chair with UV-C

Width: 36 Depth: 33 Height: 35
 AH: 24.5 SH: 19 SD: 21 IW: 23
 Weight: 65 / 79 lbs Cube: 29.69

Standard Pillows: N/A Finish Req: Y
 Standard Cushions: Endurance Standard Finish: N/A
 COM: 7.5 yards
 Standard with a UV-C system on top of the left side facing arm.

D	E	F	G	H	J	K _{COM}	L	M	N	O	P	Q	R	S	T	U	(# above U) *	S Nail	M Nail
2460	2484	2508	2532	2556	2580	2604	2628	2652	2676	2700	2724	2748	2772	2796	2820	2844	24 (Riser) + 2844 (U)	45	60

C-7454-V2

Payton Lounge Chair with Casters, UV-C

Width: 36 Depth: 33 Height: 35
 AH: 24.5 SH: 19 SD: 21 IW: 23
 Weight: 65 / 79 lbs Cube: 29.69

Standard Pillows: N/A Finish Req: Y
 Standard Cushions: Endurance Standard Finish: N/A
 COM: 7.5 yards
 Standard with front casters and a UV-C system on top of the left side facing arm.

D	E	F	G	H	J	K _{COM}	L	M	N	O	P	Q	R	S	T	U	(# above U) *	S Nail	M Nail
2496	2520	2544	2568	2592	2616	2640	2664	2688	2712	2736	2760	2784	2808	2832	2856	2880	24 (Riser) + 2880 (U)	45	60

C-7454-01

Payton Lounge Chair with Cupholder, UV-C

Width: 36 Depth: 33 Height: 35
 AH: 24.5 SH: 19 SD: 21 IW: 23
 Weight: 65 / 79 lbs Cube: 29.69

Standard Pillows: N/A Finish Req: Y
 Standard Cushions: Endurance Standard Finish: N/A
 COM: 7.5 yards
 Standard with a cupholder on top of the left side facing arm. Right side facing arm is standard with a UV-C system.

D	E	F	G	H	J	K _{COM}	L	M	N	O	P	Q	R	S	T	U	(# above U) *	S Nail	M Nail
2475	2499	2523	2547	2571	2595	2619	2643	2667	2691	2715	2739	2763	2787	2811	2835	2859	24 (Riser) + 2859 (U)	45	60

C-7463-E1

Emma EasyClean Wing Chair

Width: 34 Depth: 31 Height: 41.5
 AH: 25 SH: 19 SD: 19 IW: 20.5
 Weight: 65 / 82 lbs Cube: 41.32

Standard Pillows: N/A Finish Req: Y
 Standard Cushions: High Resiliency 35 Standard Finish: N/A
 COM: 6.5 yards
 Features an EasyClean Seat.

D	E	F	G	H	J	K _{COM}	L	M	N	O	P	Q	R	S	T	U	(# above U) *	S Nail	M Nail
2430	2454	2478	2502	2526	2550	2574	2598	2622	2646	2670	2694	2718	2742	2766	2790	2814	24 (Riser) + 2814 (U)	75	90

C-7481-E1

William EasyClean Occasional Chair

Width: 27.5 Depth: 31 Height: 35
 AH: 24 SH: 19 SD: 21 IW: 22
 Weight: 54 / 67 lbs Cube: 23.89

Standard Pillows: N/A Finish Req: Y
 Standard Cushions: High Resiliency 40 Standard Finish: N/A
 COM: 4.25 yards
 Features an EasyClean Seat.

D	E	F	G	H	J	K _{COM}	L	M	N	O	P	Q	R	S	T	U	(# above U) *	S Nail	M Nail
2355	2370	2385	2400	2415	2430	2445	2460	2475	2490	2505	2520	2535	2550	2565	2580	2595	15 (Riser) + 2595 (U)	N/A	N/A

C-7481-01

William Occasional Chair

Width: 27.5 Depth: 31 Height: 35
 AH: 24 SH: 19 SD: 20 IW: 22
 Weight: 54 / 68 lbs Cube: 23.89

Standard Pillows: N/A Finish Req: Y
 Standard Cushions: High Resiliency 40 Standard Finish: N/A
 COM: 4.25 yards

D	E	F	G	H	J	K _{COM}	L	M	N	O	P	Q	R	S	T	U	(# above U) *	S Nail	M Nail
2355	2370	2385	2400	2415	2430	2445	2460	2475	2490	2505	2520	2535	2550	2565	2580	2595	15 (Riser) + 2595 (U)	N/A	N/A

C-7482-E1

Richards EasyClean Occasional Chair

Width: 27 Depth: 32 Height: 37.5
 AH: 25 SH: 19 SD: 19.75 IW: 21.5
 Weight: 52 / 65 lbs Cube: 23.89

Standard Pillows: N/A Finish Req: Y
 Standard Cushions: High Resiliency 40 Standard Finish: N/A
 COM: 5 yards
 Features an EasyClean Seat.

D	E	F	G	H	J	K _{COM}	L	M	N	O	P	Q	R	S	T	U	(# above U) *	S Nail	M Nail
2355	2370	2385	2400	2415	2430	2445	2460	2475	2490	2505	2520	2535	2550	2565	2580	2595	15 (Riser) + 2595 (U)	N/A	N/A

UPHOLSTERY

C-7482-01

Richards Occasional Chair

Standard Pillows: N/A **Finish Req:** Y
Standard Cushions: High Resiliency 40 **Standard Finish:** N/A
COM: 5 yards

Width: 27 **Depth:** 32 **Height:** 37.5
AH: 25 **SH:** 19 **SD:** 19.75 **IW:** 21.5
Weight: 52 / 65 lbs **Cube:** 23.89

D	E	F	G	H	J	K _{COM}	L	M	N	O	P	Q	R	S	T	U	(# above U) *	S Nail	M Nail
2355	2370	2385	2400	2415	2430	2445	2460	2475	2490	2505	2520	2535	2550	2565	2580	2595	15 (Riser) + 2595 (U)	N/A	N/A

C-7508-01

Bellingham Lounge Chair

Standard Pillows: N/A **Finish Req:** Y
Standard Cushions: Endurance **Standard Finish:** N/A
COM: 7.25 yards

Width: 31.5 **Depth:** 33.5 **Height:** 39
AH: 26 **SH:** 20 **SD:** 18 **IW:** 22
Weight: 60 / 75 lbs **Cube:** 27.3

D	E	F	G	H	J	K _{COM}	L	M	N	O	P	Q	R	S	T	U	(# above U) *	S Nail	M Nail
2520	2544	2568	2592	2616	2640	2664	2688	2712	2736	2760	2784	2808	2832	2856	2880	2904	24 (Riser) + 2904 (U)	45	N/A

C-7509-01

Georgette Lounge Chair

Standard Pillows: N/A **Finish Req:** Y
Standard Cushions: Endurance **Standard Finish:** N/A
COM: 6.25 yards

Width: 28 **Depth:** 31 **Height:** 31.5
AH: 25.5 **SH:** 19.5 **SD:** 20 **IW:** 23.5
Weight: 65 / 78 lbs **Cube:** 23.89

D	E	F	G	H	J	K _{COM}	L	M	N	O	P	Q	R	S	T	U	(# above U) *	S Nail	M Nail
2325	2343	2361	2379	2397	2415	2433	2451	2469	2487	2505	2523	2541	2559	2577	2595	2613	18 (Riser) + 2613 (U)	75	90

C-7509-50

Georgette Sofa

Standard Pillows: N/A **Finish Req:** Y
Standard Cushions: Endurance **Standard Finish:** N/A
COM: 12 yards

Width: 75.5 **Depth:** 31 **Height:** 31.5
AH: 25.5 **SH:** 19.5 **SD:** 20 **IW:** 70
Weight: 98 / 133 lbs **Cube:** 68.15

D	E	F	G	H	J	K _{COM}	L	M	N	O	P	Q	R	S	T	U	(# above U) *	S Nail	M Nail
3975	4011	4047	4083	4119	4155	4191	4227	4263	4299	4335	4371	4407	4443	4479	4515	4551	36 (Riser) + 4551 (U)	105	120

C-7509-70

Georgette Loveseat

Standard Pillows: N/A **Finish Req:** Y
Standard Cushions: Endurance **Standard Finish:** N/A
COM: 9.25 yards

Width: 52 **Depth:** 31 **Height:** 31.5
AH: 25.5 **SH:** 19.5 **SD:** 20 **IW:** 46.5
Weight: 82 / 109 lbs **Cube:** 50.95

D	E	F	G	H	J	K _{COM}	L	M	N	O	P	Q	R	S	T	U	(# above U) *	S Nail	M Nail
3150	3180	3210	3240	3270	3300	3330	3360	3390	3420	3450	3480	3510	3540	3570	3600	3630	30 (Riser) + 3630 (U)	90	105

C-7516-20

Catalina Cocktail Ottoman

Standard Pillows: N/A **Finish Req:** Y
Standard Cushions: High Resiliency 30 **Standard Finish:** N/A
COM: 4.5 yards

Width: 64.75 **Depth:** 32.75 **Height:** 18
AH: - **SH:** - **SD:** - **IW:** -
Weight: 41 / 61 lbs **Cube:** 29.21

D	E	F	G	H	J	K _{COM}	L	M	N	O	P	Q	R	S	T	U	(# above U) *	S Nail	M Nail
1680	1695	1710	1725	1740	1755	1770	1785	1800	1815	1830	1845	1860	1875	1890	1905	1920	15 (Riser) + 1920 (U)	60	75

C-7516-57

Catalina Curved Corner Sofa

Standard Pillows: N/A **Finish Req:** Y
Standard Cushions: Endurance **Standard Finish:** N/A
COM: 16 yards

Width: 106.5 **Depth:** 41 **Height:** 36.75
AH: 24.5 **SH:** 19.5 **SD:** 19 **IW:** 78
Weight: 152 / 197 lbs **Cube:** 81.85

D	E	F	G	H	J	K _{COM}	L	M	N	O	P	Q	R	S	T	U	(# above U) *	S Nail	M Nail
4485	4530	4575	4620	4665	4710	4755	4800	4845	4890	4935	4980	5025	5070	5115	5160	5205	45 (Riser) + 5205 (U)	120	135

UPHOLSTERY

C-7537-E1

Aaron EasyClean Lounge Chair

Standard Pillows: N/A **Finish Req:** Y
Standard Cushions: High Resiliency 35 **Standard Finish:** N/A
COM: 7.25 yards
 Features an EasyClean Seat

Width: 30.5 **Depth:** 33.5 **Height:** 36.5
AH: 26 **SH:** 18.5 **SD:** 20 **IW:** 21
Weight: 80 / 94 lbs **Cube:** 29.69

D	E	F	G	H	J	K _{COM}	L	M	N	O	P	Q	R	S	T	U	(# above U) *	S Nail	M Nail
2325	2346	2367	2388	2409	2430	2451	2472	2493	2514	2535	2556	2577	2598	2619	2640	2661	21 (Riser) + 2661 (U)	90	105

C-7537-E5

Aaron EasyClean Sofa

Standard Pillows: N/A **Finish Req:** Y
Standard Cushions: High Resiliency 35 **Standard Finish:** N/A
COM: 11.75 yards
 Features an EasyClean Seat

Width: 79.5 **Depth:** 33.5 **Height:** 36.5
AH: 26 **SH:** 18.5 **SD:** 20 **IW:** 69.5
Weight: 125 / 160 lbs **Cube:** 68.15

D	E	F	G	H	J	K _{COM}	L	M	N	O	P	Q	R	S	T	U	(# above U) *	S Nail	M Nail
3375	3411	3447	3483	3519	3555	3591	3627	3663	3699	3735	3771	3807	3843	3879	3915	3951	36 (Riser) + 3951 (U)	135	150

C-7537-E7

Aaron EasyClean Loveseat

Standard Pillows: N/A **Finish Req:** Y
Standard Cushions: High Resiliency 35 **Standard Finish:** N/A
COM: 9.75 yards
 Features an EasyClean Seat

Width: 56 **Depth:** 33.5 **Height:** 36.5
AH: 26 **SH:** 19 **SD:** 20 **IW:** 46.5
Weight: 105 / 135 lbs **Cube:** 55.51

D	E	F	G	H	J	K _{COM}	L	M	N	O	P	Q	R	S	T	U	(# above U) *	S Nail	M Nail
2925	2955	2985	3015	3045	3075	3105	3135	3165	3195	3225	3255	3285	3315	3345	3375	3405	30 (Riser) + 3405 (U)	105	120

C-7539-T1

Aubrey Lounge Chair with Folding Tablet

Standard Pillows: N/A **Finish Req:** Y
Standard Cushions: Endurance **Standard Finish:** N/A
COM: 6 yards

Width: 29 **Depth:** 32 **Height:** 34
AH: 24 **SH:** 18.5 **SD:** 20.5 **IW:** 20.5
Weight: 41 / 55 lbs **Cube:** 29.69

D	E	F	G	H	J	K _{COM}	L	M	N	O	P	Q	R	S	T	U	(# above U) *	S Nail	M Nail
3045	3063	3081	3099	3117	3135	3153	3171	3189	3207	3225	3243	3261	3279	3297	3315	3333	18 (Riser) + 3333 (U)	75	90

C-7539-01

Aubrey Lounge Chair

Standard Pillows: N/A **Finish Req:** Y
Standard Cushions: Endurance **Standard Finish:** N/A
COM: 6 yards

Width: 29 **Depth:** 32 **Height:** 34
AH: 24 **SH:** 18.5 **SD:** 20.5 **IW:** 20.5
Weight: 35 / 48 lbs **Cube:** 23.89

D	E	F	G	H	J	K _{COM}	L	M	N	O	P	Q	R	S	T	U	(# above U) *	S Nail	M Nail
2280	2298	2316	2334	2352	2370	2388	2406	2424	2442	2460	2478	2496	2514	2532	2550	2568	18 (Riser) + 2568 (U)	75	90

C-7539-50

Aubrey Sofa

Standard Pillows: N/A **Finish Req:** Y
Standard Cushions: Endurance **Standard Finish:** N/A
COM: 9.75 yards

Width: 78 **Depth:** 32 **Height:** 34
AH: 24 **SH:** 18.5 **SD:** 20.5 **IW:** 69
Weight: 105 / 140 lbs **Cube:** 68.15

D	E	F	G	H	J	K _{COM}	L	M	N	O	P	Q	R	S	T	U	(# above U) *	S Nail	M Nail
3225	3252	3279	3306	3333	3360	3387	3414	3441	3468	3495	3522	3549	3576	3603	3630	3657	27 (Riser) + 3657 (U)	120	135

C-7539-70

Aubrey Love Seat

Standard Pillows: N/A **Finish Req:** Y
Standard Cushions: Endurance **Standard Finish:** N/A
COM: 7.75 yards

Width: 54.5 **Depth:** 32 **Height:** 34
AH: 24 **SH:** 18.5 **SD:** 20.5 **IW:** 45.5
Weight: 80 / 110 lbs **Cube:** 55.51

D	E	F	G	H	J	K _{COM}	L	M	N	O	P	Q	R	S	T	U	(# above U) *	S Nail	M Nail
2760	2781	2802	2823	2844	2865	2886	2907	2928	2949	2970	2991	3012	3033	3054	3075	3096	21 (Riser) + 3096 (U)	105	120

UPHOLSTERY

C-7540-T1

Standard Pillows: N/A **Finish Req:** Y
Standard Cushions: Endurance **Standard Finish:** N/A
COM: 6 yards

Ashleigh Lounge Chair with Folding Tablet

Width: 29 **Depth:** 32 **Height:** 34
AH: 24 **SH:** 18.5 **SD:** 20.5 **IW:** 20.5
Weight: 41 / 55 lbs **Cube:** 23.89

D	E	F	G	H	J	K _{COM}	L	M	N	O	P	Q	R	S	T	U	(# above U) *	S Nail	M Nail
3045	3063	3081	3099	3117	3135	3153	3171	3189	3207	3225	3243	3261	3279	3297	3315	3333	18 (Riser) + 3333 (U)	75	90

C-7553-E1

Standard Pillows: N/A **Finish Req:** Y
Standard Cushions: High Resiliency 35 **Standard Finish:** N/A
COM: 5 yards

Abegail EasyClean Lounge Chair

Width: 27 **Depth:** 30 **Height:** 31
AH: 24.5 **SH:** 19.5 **SD:** 20 **IW:** 20
Weight: 50 / 63 lbs **Cube:** 21.65

D	E	F	G	H	J	K _{COM}	L	M	N	O	P	Q	R	S	T	U	(# above U) *	S Nail	M Nail
2175	2193	2211	2229	2247	2265	2283	2301	2319	2337	2355	2373	2391	2409	2427	2445	2463	18 (Riser) + 2463 (U)	45	60

C-7553-E5

Standard Pillows: N/A **Finish Req:** Y
Standard Cushions: High Resiliency 35 **Standard Finish:** N/A
COM: 8.25 yards

Abegail EasyClean Sofa

Width: 76 **Depth:** 30 **Height:** 31
AH: 24.5 **SH:** 19.5 **SD:** 20 **IW:** 70
Weight: 145 / 180 lbs **Cube:** 68.15

D	E	F	G	H	J	K _{COM}	L	M	N	O	P	Q	R	S	T	U	(# above U) *	S Nail	M Nail
3120	3144	3168	3192	3216	3240	3264	3288	3312	3336	3360	3384	3408	3432	3456	3480	3504	24 (Riser) + 3504 (U)	75	90

C-7553-E7

Standard Pillows: N/A **Finish Req:** Y
Standard Cushions: High Resiliency 35 **Standard Finish:** N/A
COM: 6.5 yards

Abegail EasyClean Loveseat

Width: 52.5 **Depth:** 30 **Height:** 31
AH: 24.5 **SH:** 19.5 **SD:** 20 **IW:** 46.5
Weight: 100 / 130 lbs **Cube:** 55.51

D	E	F	G	H	J	K _{COM}	L	M	N	O	P	Q	R	S	T	U	(# above U) *	S Nail	M Nail
2670	2688	2706	2724	2742	2760	2778	2796	2814	2832	2850	2868	2886	2904	2922	2940	2958	18 (Riser) + 2958 (U)	60	75

C-7553-01

Standard Pillows: N/A **Finish Req:** Y
Standard Cushions: Endurance **Standard Finish:** N/A
COM: 5.25 yards

Abegail Lounge Chair

Width: 28.5 **Depth:** 28.5 **Height:** 34.5
AH: 24.5 **SH:** 20 **SD:** 20 **IW:** 20
Weight: 35 / 48 lbs **Cube:** 23.89

D	E	F	G	H	J	K _{COM}	L	M	N	O	P	Q	R	S	T	U	(# above U) *	S Nail	M Nail
2235	2253	2271	2289	2307	2325	2343	2361	2379	2397	2415	2433	2451	2469	2487	2505	2523	18 (Riser) + 2523 (U)	45	60

C-7553-70

Standard Pillows: N/A **Finish Req:** Y
Standard Cushions: Endurance **Standard Finish:** N/A
COM: 9 yards

Abegail Loveseat

Width: 52.5 **Depth:** 30 **Height:** 31
AH: 24.5 **SH:** 20 **SD:** 20 **IW:** 46.5
Weight: 95 / 122 lbs **Cube:** 50.95

D	E	F	G	H	J	K _{COM}	L	M	N	O	P	Q	R	S	T	U	(# above U) *	S Nail	M Nail
2775	2799	2823	2847	2871	2895	2919	2943	2967	2991	3015	3039	3063	3087	3111	3135	3159	24 (Riser) + 3159 (U)	60	75

C-7558-E1

Standard Pillows: N/A **Finish Req:** Y
Standard Cushions: High Resiliency 30 **Standard Finish:** N/A
COM: 6.5 yards
 Features an EasyClean Seat

Ross EasyClean Lounge Chair

Width: 30.5 **Depth:** 34.5 **Height:** 36
AH: 25.5 **SH:** 18.5 **SD:** 20 **IW:** 20.5
Weight: 75 / 89 lbs **Cube:** 29.69

D	E	F	G	H	J	K _{COM}	L	M	N	O	P	Q	R	S	T	U	(# above U) *	S Nail	M Nail
2265	2286	2307	2328	2349	2370	2391	2412	2433	2454	2475	2496	2517	2538	2559	2580	2601	21 (Riser) + 2601 (U)	45	N/A

UPHOLSTERY

C-7558-E5

Ross EasyClean Sofa

Standard Pillows: N/A **Finish Req:** Y
Standard Cushions: High Resiliency 35 **Standard Finish:** N/A
COM: 10.25 yards
 Features an EasyClean Seat

Width: 80.5 **Depth:** 34 **Height:** 36
AH: 25.5 **SH:** 19 **SD:** 20 **IW:** 69.5
Weight: 125 / 160 lbs **Cube:** 68.15

D	E	F	G	H	J	K _{COM}	L	M	N	O	P	Q	R	S	T	U	(# above U) *	S Nail	M Nail
3450	3486	3522	3558	3594	3630	3666	3702	3738	3774	3810	3846	3882	3918	3954	3990	4026	36 (Riser) + 4026 (U)	75	N/A

C-7558-E7

Ross EasyClean Loveseat

Standard Pillows: N/A **Finish Req:** Y
Standard Cushions: High Resiliency 35 **Standard Finish:** N/A
COM: 8.25 yards
 Features an EasyClean Seat

Width: 56.5 **Depth:** 34 **Height:** 36
AH: 26 **SH:** 18.5 **SD:** 20 **IW:** 48
Weight: 105 / 115 lbs **Cube:** 55.51

D	E	F	G	H	J	K _{COM}	L	M	N	O	P	Q	R	S	T	U	(# above U) *	S Nail	M Nail
3045	3075	3105	3135	3165	3195	3225	3255	3285	3315	3345	3375	3405	3435	3465	3495	3525	30 (Riser) + 3525 (U)	60	N/A

C-7560-01

Sloane Lounge Chair

Standard Pillows: N/A **Finish Req:** Y
Standard Cushions: Endurance **Standard Finish:** N/A
COM: 7 yards

Width: 37 **Depth:** 32 **Height:** 34
AH: 23 **SH:** 19.5 **SD:** 20 **IW:** 21
Weight: 51 / 65 lbs **Cube:** 29.69

D	E	F	G	H	J	K _{COM}	L	M	N	O	P	Q	R	S	T	U	(# above U) *	S Nail	M Nail
2385	2406	2427	2448	2469	2490	2511	2532	2553	2574	2595	2616	2637	2658	2679	2700	2721	21 (Riser) + 2721 (U)	45	60

C-7566-E1

Blake EasyClean Lounge Chair

Standard Pillows: N/A **Finish Req:** Y
Standard Cushions: High Resiliency 35 **Standard Finish:** N/A
COM: 7 yards
 Features an EasyClean Seat

Width: 30 **Depth:** 32.5 **Height:** 36.5
AH: 25 **SH:** 19 **SD:** 19.5 **IW:** 22
Weight: 56 / 69 lbs **Cube:** 23.89

D	E	F	G	H	J	K _{COM}	L	M	N	O	P	Q	R	S	T	U	(# above U) *	S Nail	M Nail
2145	2166	2187	2208	2229	2250	2271	2292	2313	2334	2355	2376	2397	2418	2439	2460	2481	21 (Riser) + 2481 (U)	75	90

C-7566-E5

Blake EasyClean Sofa

Standard Pillows: N/A **Finish Req:** Y
Standard Cushions: High Resiliency 35 **Standard Finish:** N/A
COM: 11 yards
 Features an EasyClean Seat

Width: 75.5 **Depth:** 32.5 **Height:** 36.5
AH: 25 **SH:** 19 **SD:** 19.5 **IW:** 71
Weight: 100 / 135 lbs **Cube:** 70.78

D	E	F	G	H	J	K _{COM}	L	M	N	O	P	Q	R	S	T	U	(# above U) *	S Nail	M Nail
3045	3075	3105	3135	3165	3195	3225	3255	3285	3315	3345	3375	3405	3435	3465	3495	3525	30 (Riser) + 3525 (U)	120	135

C-7566-E7

Blake EasyClean Loveseat

Standard Pillows: N/A **Finish Req:** Y
Standard Cushions: High Resiliency 35 **Standard Finish:** N/A
COM: 9.25 yards
 Features an EasyClean Seat

Width: 51.5 **Depth:** 32.5 **Height:** 36.5
AH: 25 **SH:** 19 **SD:** 19.5 **IW:** 46
Weight: 81 / 108 lbs **Cube:** 50.95

D	E	F	G	H	J	K _{COM}	L	M	N	O	P	Q	R	S	T	U	(# above U) *	S Nail	M Nail
2670	2697	2724	2751	2778	2805	2832	2859	2886	2913	2940	2967	2994	3021	3048	3075	3102	27 (Riser) + 3102 (U)	105	120

C-7566-01

Blake Lounge Chair

Standard Pillows: N/A **Finish Req:** Y
Standard Cushions: Endurance **Standard Finish:** N/A
COM: 6.75 yards

Width: 30 **Depth:** 32.5 **Height:** 36.5
AH: 25.5 **SH:** 19 **SD:** 18.5 **IW:** 22
Weight: 48 / 62 lbs **Cube:** 29.69

D	E	F	G	H	J	K _{COM}	L	M	N	O	P	Q	R	S	T	U	(# above U) *	S Nail	M Nail
2265	2286	2307	2328	2349	2370	2391	2412	2433	2454	2475	2496	2517	2538	2559	2580	2601	21 (Riser) + 2601 (U)	75	90

UPHOLSTERY

C-7566-50

Standard Pillows: N/A **Finish Req:** Y
Standard Cushions: Endurance **Standard Finish:** N/A
COM: 12.5 yards

Blake Sofa

Width: 76 **Depth:** 32.5 **Height:** 36.5
AH: 25.5 **SH:** 19 **SD:** 18.5 **IW:** 70.5
Weight: 105 / 140 lbs **Cube:** 68.15

D	E	F	G	H	J	K _{COM}	L	M	N	O	P	Q	R	S	T	U	(# above U) *	S Nail	M Nail
3450	3486	3522	3558	3594	3630	3666	3702	3738	3774	3810	3846	3882	3918	3954	3990	4026	36 (Riser) + 4026 (U)	120	135

C-7566-70

Standard Pillows: N/A **Finish Req:** Y
Standard Cushions: Endurance **Standard Finish:** N/A
COM: 9.25 yards

Blake Loveseat

Width: 52 **Depth:** 32.5 **Height:** 36.5
AH: 25.5 **SH:** 19 **SD:** 18.5 **IW:** 44.5
Weight: 78 / 108 lbs **Cube:** 50.95

D	E	F	G	H	J	K _{COM}	L	M	N	O	P	Q	R	S	T	U	(# above U) *	S Nail	M Nail
2955	2982	3009	3036	3063	3090	3117	3144	3171	3198	3225	3252	3279	3306	3333	3360	3387	27 (Riser) + 3387 (U)	105	120

C-7570-01

Standard Pillows: N/A **Finish Req:** Y
Standard Cushions: Endurance **Standard Finish:** N/A
COM: 7 yards

Holden Lounge Chair

Width: 37 **Depth:** 32 **Height:** 34
AH: 23 **SH:** 19.5 **SD:** 20 **IW:** 21
Weight: 51 / 65 lbs **Cube:** 29.69

D	E	F	G	H	J	K _{COM}	L	M	N	O	P	Q	R	S	T	U	(# above U) *	S Nail	M Nail
2400	2421	2442	2463	2484	2505	2526	2547	2568	2589	2610	2631	2652	2673	2694	2715	2736	21 (Riser) + 2736 (U)	45	60

C-7590-01

Standard Pillows: N/A **Finish Req:** Y
Standard Cushions: Endurance **Standard Finish:** N/A
COM: 7.25 yards

Dylan Lounge Chair

Width: 30.5 **Depth:** 36 **Height:** 43.5
AH: 25 **SH:** 19.5 **SD:** 18.5 **IW:** 20.5
Weight: 65 / 79 lbs **Cube:** 29.69

D	E	F	G	H	J	K _{COM}	L	M	N	O	P	Q	R	S	T	U	(# above U) *	S Nail	M Nail
2400	2424	2448	2472	2496	2520	2544	2568	2592	2616	2640	2664	2688	2712	2736	2760	2784	24 (Riser) + 2784 (U)	45	60

C-7590-50

Standard Pillows: (3) Kidney **Finish Req:** Y
Standard Cushions: Endurance **Standard Finish:** N/A
COM: 13.25 yards

Dylan Sofa

Width: 73.5 **Depth:** 36 **Height:** 35.5
AH: 25.5 **SH:** 20 **SD:** 19.5 **IW:** 63.5
Weight: 110 / 144 lbs **Cube:** 70.78

D	E	F	G	H	J	K _{COM}	L	M	N	O	P	Q	R	S	T	U	(# above U) *	S Nail	M Nail
3975	4011	4047	4083	4119	4155	4191	4227	4263	4299	4335	4371	4407	4443	4479	4515	4551	36 (Riser) + 4551 (U)	75	90

C-7590-70

Standard Pillows: N/A **Finish Req:** Y
Standard Cushions: Endurance **Standard Finish:** N/A
COM: 10.25 yards

Dylan Loveseat

Width: 61 **Depth:** 36 **Height:** 38
AH: 25.5 **SH:** 20 **SD:** 19.5 **IW:** 42
Weight: 125 / 155 lbs **Cube:** 55.51

D	E	F	G	H	J	K _{COM}	L	M	N	O	P	Q	R	S	T	U	(# above U) *	S Nail	M Nail
3285	3315	3345	3375	3405	3435	3465	3495	3525	3555	3585	3615	3645	3675	3705	3735	3765	30 (Riser) + 3765 (U)	60	75

C-7710-33

Standard Pillows: N/A **Finish Req:** Y
Standard Cushions: High Resiliency 30 **Standard Finish:** N/A
COM: 8 yards
 Requires 17-1/2" Wall Clearance. Push Back

Mannington Manual Recliner

Width: 28 **Depth:** 36 **Height:** 42.5
AH: 25 **SH:** 19 **SD:** 19.5 **IW:** 22 **Recl D:** 65 **TV Recl:** 0 **Wall Clr:** 17.5
Weight: 110 / 128 lbs **Cube:** 41.32

D	E	F	G	H	J	K _{COM}	L	M	N	O	P	Q	R	S	T	U	(# above U) *	S Nail	M Nail
3045	3069	3093	3117	3141	3165	3189	3213	3237	3261	3285	3309	3333	3357	3381	3405	3429	24 (Riser) + 3429 (U)	45	N/A

UPHOLSTERY

C-7829-E1

Dianna EasyClean Wing Chair

Standard Pillows: N/A **Finish Req:** Y
Standard Cushions: High Resiliency 30 **Standard Finish:** N/A
COM: 6.25 yards
 Features an EasyClean Seat

Width: 28 **Depth:** 32 **Height:** 41
AH: 26 **SH:** 19 **SD:** 20 **IW:** 23
Weight: 70 / 86 lbs **Cube:** 34.38

D	E	F	G	H	J	K _{COM}	L	M	N	O	P	Q	R	S	T	U	(# above U) *	S Nail	M Nail
2235	2253	2271	2289	2307	2325	2343	2361	2379	2397	2415	2433	2451	2469	2487	2505	2523	18 (Riser) + 2523 (U)	45	60

S-5118-01

Grace Wing Chair

Standard Pillows: N/A **Finish Req:** Y
Standard Cushions: Endurance **Standard Finish:** N/A
COM: 4.75 yards

Width: 30.5 **Depth:** 31 **Height:** 44
AH: 25 **SH:** 20 **SD:** 18.5 **IW:** 20
Weight: 50 / 60 lbs **Cube:** 26.89

D	E	F	G	H	J	K _{COM}	L	M	N	O	P	Q	R	S	T	U	(# above U) *	S Nail	M Nail
2040	2055	2070	2085	2100	2115	2130	2145	2160	2175	2190	2205	2220	2235	2250	2265	2280	15 (Riser) + 2280 (U)	45	60

S-7111-E1

Scarlett EasyClean Wing Chair

Standard Pillows: N/A **Finish Req:** Y
Standard Cushions: High Resiliency 30 **Standard Finish:** N/A
COM: 5.25 yards
 Features an EasyClean Seat

Width: 30.5 **Depth:** 30.5 **Height:** 42.5
AH: 26 **SH:** 18.5 **SD:** 19.5 **IW:** 19.5
Weight: 55 / 65 lbs **Cube:** 27.3

D	E	F	G	H	J	K _{COM}	L	M	N	O	P	Q	R	S	T	U	(# above U) *	S Nail	M Nail
2250	2265	2280	2295	2310	2325	2340	2355	2370	2385	2400	2415	2430	2445	2460	2475	2490	15 (Riser) + 2490 (U)	45	60

S-7113-E1

Highland EasyClean Wing Chair

Standard Pillows: N/A **Finish Req:** Y
Standard Cushions: High Resiliency 30 **Standard Finish:** N/A
COM: 5.25 yards
 Features an EasyClean Seat and Tapered Legs

Width: 30 **Depth:** 30 **Height:** 42.5
AH: 26 **SH:** 19 **SD:** 19.5 **IW:** 20
Weight: 55 / 60 lbs **Cube:** 26.89

D	E	F	G	H	J	K _{COM}	L	M	N	O	P	Q	R	S	T	U	(# above U) *	S Nail	M Nail
2250	2265	2280	2295	2310	2325	2340	2355	2370	2385	2400	2415	2430	2445	2460	2475	2490	15 (Riser) + 2490 (U)	45	60

S-7113-01

Highland Wing Chair

Standard Pillows: N/A **Finish Req:** Y
Standard Cushions: Endurance **Standard Finish:** N/A
COM: 5.25 yards

Width: 30.5 **Depth:** 30.5 **Height:** 42.5
AH: 26 **SH:** 20 **SD:** 19.5 **IW:** 19.5
Weight: 60 / 60 lbs **Cube:** 26.89

D	E	F	G	H	J	K _{COM}	L	M	N	O	P	Q	R	S	T	U	(# above U) *	S Nail	M Nail
2250	2265	2280	2295	2310	2325	2340	2355	2370	2385	2400	2415	2430	2445	2460	2475	2490	15 (Riser) + 2490 (U)	45	N/A

S-7156-01

Ainsworth Lounge Chair

Standard Pillows: N/A **Finish Req:** Y
Standard Cushions: Endurance **Standard Finish:** N/A
COM: 8.25 yards

Width: 33 **Depth:** 34.5 **Height:** 41
AH: 24.5 **SH:** 19.5 **SD:** 20 **IW:** 25
Weight: 60 / 70 lbs **Cube:** 33.92

D	E	F	G	H	J	K _{COM}	L	M	N	O	P	Q	R	S	T	U	(# above U) *	S Nail	M Nail
2370	2397	2424	2451	2478	2505	2532	2559	2586	2613	2640	2667	2694	2721	2748	2775	2802	27 (Riser) + 2802 (U)	45	60

S-7405-E1

Clarice EasyClean Lounge Chair
 Removable Seat Deck

Standard Pillows: N/A **Finish Req:** Y
Standard Cushions: Endurance **Standard Finish:** N/A
COM: 7.5 yards
 Features a removable seat deck with moisture barrier cover in cambric.

Width: 21.5 **Depth:** 27.5 **Height:** 39.25
AH: 25.5 **SH:** 18.5 **SD:** 19.5 **IW:** 21
Weight: 68 / 68 lbs **Cube:** 13.42

D	E	F	G	H	J	K _{COM}	L	M	N	O	P	Q	R	S	T	U	(# above U) *	S Nail	M Nail
2475	2496	2517	2538	2559	2580	2601	2622	2643	2664	2685	2706	2727	2748	2769	2790	2811	21 (Riser) + 2811 (U)	45	60

UPHOLSTERY

S-7405-01

Standard Pillows: N/A **Finish Req:** Y
Standard Cushions: Endurance **Standard Finish:** N/A
COM: 7.5 yards

Clarice Lounge Chair

Width: 32.25 **Depth:** 32.5 **Height:** 32
AH: 25.5 **SH:** 18.5 **SD:** 19.5 **IW:** 21
Weight: 68 / 68 lbs **Cube:** 19.4

D	E	F	G	H	J	K _{COM}	L	M	N	O	P	Q	R	S	T	U	(# above U) *	S Nail	M Nail
2475	2496	2517	2538	2559	2580	2601	2622	2643	2664	2685	2706	2727	2748	2769	2790	2811	21 (Riser) + 2811 (U)	45	60

S-7406-E1

Standard Pillows: N/A **Finish Req:** Y
Standard Cushions: Endurance **Standard Finish:** traditional
COM: 8.25 yards
Features a removable seat deck with moisture barrier cover in cambric.

Coltrane EasyClean Skirted Lounge Chair

Removable Seat Deck

Width: 31.75 **Depth:** 35.5 **Height:** 38
AH: 24.25 **SH:** 20 **SD:** 19 **IW:** 21
Weight: 65 / 65 lbs **Cube:** 29.69

D	E	F	G	H	J	K _{COM}	L	M	N	O	P	Q	R	S	T	U	(# above U) *	S Nail	M Nail
2550	2574	2598	2622	2646	2670	2694	2718	2742	2766	2790	2814	2838	2862	2886	2910	2934	24 (Riser) + 2934 (U)	N/A	N/A

S-7408-E1

Standard Pillows: N/A **Finish Req:** N
Standard Cushions: Endurance **Standard Finish:** N/A
COM: 5.5 yards
Our Easy Clean seat construction features a removable seat cushion and deck, designed to easily lift out of the seat frame for quick removal and simple clean up. The suspension beneath the cushion includes a webbed seat deck with moisture barrier and a cam

Brynn Easy Clean Lounge Chair

Removable Seat Deck

Width: 34.5 **Depth:** 31.5 **Height:** 30.5
AH: 27 **SH:** 20 **SD:** 22 **IW:** 22
Weight: 70 / 84 lbs **Cube:** 29.69

D	E	F	G	H	J	K _{COM}	L	M	N	O	P	Q	R	S	T	U	(# above U) *	S Nail	M Nail
2400	2418	2436	2454	2472	2490	2508	2526	2544	2562	2580	2598	2616	2634	2652	2670	2688	18 (Riser) + 2688 (U)	Std.	N/A

S-7408-E3

Standard Pillows: N/A **Finish Req:** Y
Standard Cushions: Endurance **Standard Finish:** N/A
COM: 5.5 yards
Our Easy Clean seat construction features a removable seat cushion and deck, designed to easily lift out of the seat frame for quick removal and simple clean up. The suspension beneath the cushion includes a webbed seat deck with moisture barrier and a cam

Brynn Easy Clean Swivel Chair

Removable Seat Deck

Width: 34.5 **Depth:** 31.5 **Height:** 30.5
AH: 27 **SH:** 20 **SD:** 22 **IW:** 22
Weight: 70 / 70 lbs **Cube:** 19.18

D	E	F	G	H	J	K _{COM}	L	M	N	O	P	Q	R	S	T	U	(# above U) *	S Nail	M Nail
2475	2493	2511	2529	2547	2565	2583	2601	2619	2637	2655	2673	2691	2709	2727	2745	2763	18 (Riser) + 2763 (U)	90	N/A

S-7409-E3

Standard Pillows: N/A **Finish Req:** Y
Standard Cushions: Endurance **Standard Finish:** N/A
COM: 4.75 yards
Features a removable seat deck with moisture barrier cover in cambric.

Arlo EasyClean Swivel Chair

Removable Seat Deck

Width: 27 **Depth:** 30.5 **Height:** 29.25
AH: 25.25 **SH:** 19.5 **SD:** 21.25 **IW:** 20.75
Weight: 59 / 59 lbs **Cube:** 13.93

D	E	F	G	H	J	K _{COM}	L	M	N	O	P	Q	R	S	T	U	(# above U) *	S Nail	M Nail
2250	2265	2280	2295	2310	2325	2340	2355	2370	2385	2400	2415	2430	2445	2460	2475	2490	15 (Riser) + 2490 (U)	75	90

S-7411-E1

Standard Pillows: N/A **Finish Req:** Y
Standard Cushions: Endurance **Standard Finish:** N/A
COM: 6.75 yards
Our Easy Clean seat construction features a removable seat cushion and deck, designed to easily lift out of the seat frame for quick removal and simple clean up. The suspension beneath the cushion includes a webbed seat deck with moisture barrier and a cam

Capelli Easy Clean Wing Chair

Removable Seat Deck

Width: 34.25 **Depth:** 33.5 **Height:** 47.5
AH: 25.5 **SH:** 22.5 **SD:** 20 **IW:** 21
Weight: 49 / 49 lbs **Cube:** 37.51

D	E	F	G	H	J	K _{COM}	L	M	N	O	P	Q	R	S	T	U	(# above U) *	S Nail	M Nail
2685	2706	2727	2748	2769	2790	2811	2832	2853	2874	2895	2916	2937	2958	2979	3000	3021	21 (Riser) + 3021 (U)	Std.	N/A

S-7412-01

Standard Pillows: N/A **Finish Req:** Y
Standard Cushions: Endurance **Standard Finish:** N/A
COM: 5.25 yards

Evanston Lounge Chair

Width: 32.5 **Depth:** 34.5 **Height:** 32.5
AH: 27 **SH:** 19 **SD:** 19 **IW:** 21.5
Weight: 55 / 65 lbs **Cube:** 29.29

D	E	F	G	H	J	K _{COM}	L	M	N	O	P	Q	R	S	T	U	(# above U) *	S Nail	M Nail
2250	2268	2286	2304	2322	2340	2358	2376	2394	2412	2430	2448	2466	2484	2502	2520	2538	18 (Riser) + 2538 (U)	45	60

UPHOLSTERY

S-7413-E1

Collins EasyClean Wing Chair

Standard Pillows: N/A **Finish Req:** Y
Standard Cushions: High Resiliency 40 **Standard Finish:** N/A
COM: 7.25 yards
 Features an EasyClean Seat.

Width: 31 **Depth:** 33.5 **Height:** 41.5
AH: 25.5 **SH:** 19.5 **SD:** 20 **IW:** 23.5
Weight: 65 / 75 lbs **Cube:** 33.92

D	E	F	G	H	J	K COM	L	M	N	O	P	Q	R	S	T	U	(# above U) *	S Nail	M Nail
2475	2496	2517	2538	2559	2580	2601	2622	2643	2664	2685	2706	2727	2748	2769	2790	2811	21 (Riser) + 2811 (U)	75	90

S-7413-01

Collins Wing Chair

Standard Pillows: N/A **Finish Req:** Y
Standard Cushions: Endurance **Standard Finish:** N/A
COM: 7.25 yards

Width: 31 **Depth:** 33.5 **Height:** 41.5
AH: 25.5 **SH:** 19.5 **SD:** 20 **IW:** 23.5
Weight: 90 / 100 lbs **Cube:** 34.38

D	E	F	G	H	J	K COM	L	M	N	O	P	Q	R	S	T	U	(# above U) *	S Nail	M Nail
2475	2496	2517	2538	2559	2580	2601	2622	2643	2664	2685	2706	2727	2748	2769	2790	2811	21 (Riser) + 2811 (U)	75	90

S-7414-E1

Mariah EasyClean Lounge Chair
 Removable Seat Deck

Standard Pillows: 1 Kidney **Finish Req:** Y
Standard Cushions: Endurance **Standard Finish:** N/A
COM: 6.25 yards
 Features a removable seat deck with moisture barrier cover in cambric. Removable lumbar pillow.

Width: 30.5 **Depth:** 32.5 **Height:** 40.5
AH: 24 **SH:** 20 **SD:** 17.5 **IW:** 23
Weight: 51 / 51 lbs **Cube:** 23.23

D	E	F	G	H	J	K COM	L	M	N	O	P	Q	R	S	T	U	(# above U) *	S Nail	M Nail
2475	2493	2511	2529	2547	2565	2583	2601	2619	2637	2655	2673	2691	2709	2727	2745	2763	18 (Riser) + 2763 (U)	Std.	N/A

S-7414-01

Mariah Lounge Chair

Standard Pillows: 1 Kidney **Finish Req:** Y
Standard Cushions: Endurance **Standard Finish:** N/A
COM: 6.25 yards

Width: 30.5 **Depth:** 32.5 **Height:** 40.5
AH: 24 **SH:** 20 **SD:** 17.5 **IW:** 23
Weight: 51 / 51 lbs **Cube:** 23.23

D	E	F	G	H	J	K COM	L	M	N	O	P	Q	R	S	T	U	(# above U) *	S Nail	M Nail
2475	2493	2511	2529	2547	2565	2583	2601	2619	2637	2655	2673	2691	2709	2727	2745	2763	18 (Riser) + 2763 (U)	Std.	N/A

S-7418-01

Cloe Lounge Chair

Standard Pillows: N/A **Finish Req:** Y
Standard Cushions: Endurance **Standard Finish:** N/A
COM: 5 yards

Width: 30 **Depth:** 30.5 **Height:** 31.5
AH: 28.5 **SH:** 19.5 **SD:** 19.5 **IW:** 20
Weight: 90 / 103 lbs **Cube:** 23.89

D	E	F	G	H	J	K COM	L	M	N	O	P	Q	R	S	T	U	(# above U) *	S Nail	M Nail
2130	2145	2160	2175	2190	2205	2220	2235	2250	2265	2280	2295	2310	2325	2340	2355	2370	15 (Riser) + 2370 (U)	N/A	N/A

S-7444-E1

Greenbrier EasyClean Wing Chair

Standard Pillows: N/A **Finish Req:** Y
Standard Cushions: High Resiliency 40 **Standard Finish:** N/A
COM: 4.5 yards
 Features an EasyClean Seat.

Width: 26.75 **Depth:** 27.75 **Height:** 39
AH: 24 **SH:** 18.5 **SD:** 18.5 **IW:** 20
Weight: 48 / 63 lbs **Cube:** 27.3

D	E	F	G	H	J	K COM	L	M	N	O	P	Q	R	S	T	U	(# above U) *	S Nail	M Nail
2025	2040	2055	2070	2085	2100	2115	2130	2145	2160	2175	2190	2205	2220	2235	2250	2265	15 (Riser) + 2265 (U)	60	N/A

S-7451-E1

Sydney EasyClean Wing Chair

Standard Pillows: N/A **Finish Req:** Y
Standard Cushions: High Resiliency 35 **Standard Finish:** N/A
COM: 7 yards
 Features an EasyClean Seat.

Width: 30.5 **Depth:** 36 **Height:** 43.5
AH: 26 **SH:** 19.5 **SD:** 18.5 **IW:** 20
Weight: 65 / 75 lbs **Cube:** 33.92

D	E	F	G	H	J	K COM	L	M	N	O	P	Q	R	S	T	U	(# above U) *	S Nail	M Nail
2325	2346	2367	2388	2409	2430	2451	2472	2493	2514	2535	2556	2577	2598	2619	2640	2661	21 (Riser) + 2661 (U)	45	60

UPHOLSTERY

S-7452-E1

Ella EasyClean Wing Chair

Standard Pillows: N/A **Finish Req:** Y
Standard Cushions: High Resiliency 35 **Standard Finish:** N/A
COM: 6.5 yards
 Features an EasyClean Seat.

Width: 29 **Depth:** 32 **Height:** 44
AH: 25 **SH:** 19.5 **SD:** 20 **IW:** 20
Weight: 65 / 75 lbs **Cube:** 33.92

D	E	F	G	H	J	K _{COM}	L	M	N	O	P	Q	R	S	T	U	(# above U) *	S Nail	M Nail
2250	2268	2286	2304	2322	2340	2358	2376	2394	2412	2430	2448	2466	2484	2502	2520	2538	18 (Riser) + 2538 (U)	75	90

S-7463-E1

Emma EasyClean Wing Chair

Standard Pillows: N/A **Finish Req:** Y
Standard Cushions: High Resiliency 35 **Standard Finish:** N/A
COM: 6.5 yards
 Features an EasyClean Seat.

Width: 34 **Depth:** 31 **Height:** 41.5
AH: 25 **SH:** 19 **SD:** 19 **IW:** 20.5
Weight: 65 / 75 lbs **Cube:** 33.92

D	E	F	G	H	J	K _{COM}	L	M	N	O	P	Q	R	S	T	U	(# above U) *	S Nail	M Nail
2430	2454	2478	2502	2526	2550	2574	2598	2622	2646	2670	2694	2718	2742	2766	2790	2814	24 (Riser) + 2814 (U)	75	90

S-7463-01

Emma Wing Chair

Standard Pillows: N/A **Finish Req:** Y
Standard Cushions: Endurance **Standard Finish:** N/A
COM: 6.75 yards

Width: 34 **Depth:** 35 **Height:** 40.5
AH: 25 **SH:** 19.5 **SD:** 19.5 **IW:** 20
Weight: 65 / 75 lbs **Cube:** 33.92

D	E	F	G	H	J	K _{COM}	L	M	N	O	P	Q	R	S	T	U	(# above U) *	S Nail	M Nail
2430	2454	2478	2502	2526	2550	2574	2598	2622	2646	2670	2694	2718	2742	2766	2790	2814	24 (Riser) + 2814 (U)	75	90

S-7504-01

Fairborn Lounge Chair

Standard Pillows: N/A **Finish Req:** Y
Standard Cushions: Endurance **Standard Finish:** N/A
COM: 8.25 yards

Width: 37 **Depth:** 32.5 **Height:** 35.5
AH: 27 **SH:** 19 **SD:** 18.5 **IW:** 20.5
Weight: 80 / 90 lbs **Cube:** 34.17

D	E	F	G	H	J	K _{COM}	L	M	N	O	P	Q	R	S	T	U	(# above U) *	S Nail	M Nail
2475	2499	2523	2547	2571	2595	2619	2643	2667	2691	2715	2739	2763	2787	2811	2835	2859	24 (Riser) + 2859 (U)	N/A	N/A

S-7505-01

Brownlee Lounge Chair

Standard Pillows: N/A **Finish Req:** Y
Standard Cushions: Endurance **Standard Finish:** N/A
COM: 8 yards

Width: 35.5 **Depth:** 33 **Height:** 36
AH: 26.5 **SH:** 20 **SD:** 18.5 **IW:** 24
Weight: 67 / 81 lbs **Cube:** 29.69

D	E	F	G	H	J	K _{COM}	L	M	N	O	P	Q	R	S	T	U	(# above U) *	S Nail	M Nail
2400	2427	2454	2481	2508	2535	2562	2589	2616	2643	2670	2697	2724	2751	2778	2805	2832	27 (Riser) + 2832 (U)	45	60

S-7507-01

Corryn Lounge Chair

Standard Pillows: N/A **Finish Req:** Y
Standard Cushions: High Resiliency 40 **Standard Finish:** N/A
COM: 7.25 yards

Width: 36.75 **Depth:** 32.75 **Height:** 36
AH: 32 **SH:** 19 **SD:** 18 **IW:** 24.25
Weight: 76 / 93 lbs **Cube:** 36.73

D	E	F	G	H	J	K _{COM}	L	M	N	O	P	Q	R	S	T	U	(# above U) *	S Nail	M Nail
2385	2409	2433	2457	2481	2505	2529	2553	2577	2601	2625	2649	2673	2697	2721	2745	2769	24 (Riser) + 2769 (U)	45	60

S-7510-01

Covington Lounge Chair

Standard Pillows: N/A **Finish Req:** Y
Standard Cushions: Endurance **Standard Finish:** N/A
COM: 7 yards

Width: 34 **Depth:** 31 **Height:** 37
AH: 24.5 **SH:** 19 **SD:** 19 **IW:** 22
Weight: 70 / 80 lbs **Cube:** 29.29

D	E	F	G	H	J	K _{COM}	L	M	N	O	P	Q	R	S	T	U	(# above U) *	S Nail	M Nail
2325	2349	2373	2397	2421	2445	2469	2493	2517	2541	2565	2589	2613	2637	2661	2685	2709	24 (Riser) + 2709 (U)	45	60

UPHOLSTERY

S-7511-E5

Tucker Easy Clean Sofa

Removable Seat Deck

Width: 84 Depth: 34.5 Height: 34.5

AH: 24.5 SH: 19 SD: 19.5 IW: 70

Weight: 150 / 150 lbs Cube: 79.34

Standard Pillows: (3) Kidney Pillows Finish Req: Y

Standard Cushions: Endurance Standard Finish: N/A

COM: 15.5 yards

Our Easy Clean seat construction features a removable seat cushion and deck, designed to easily lift out of the seat frame for quick removal and simple clean up. The suspension beneath the cushion includes a webbed seat deck with moisture barrier and a cam

D	E	F	G	H	J	K _{COM}	L	M	N	O	P	Q	R	S	T	U	(# above U) *	S Nail	M Nail
4485	4530	4575	4620	4665	4710	4755	4800	4845	4890	4935	4980	5025	5070	5115	5160	5205	45 (Riser) + 5205 (U)	60	75

S-7514-01

Connor Lounge Chair

Width: 31 Depth: 33.5 Height: 36.5

AH: 27 SH: 19.5 SD: 19 IW: 21.5

Weight: 85 / 95 lbs Cube: 29.29

Standard Pillows: N/A Finish Req: Y

Standard Cushions: Endurance Standard Finish: N/A

COM: 8 yards

D	E	F	G	H	J	K _{COM}	L	M	N	O	P	Q	R	S	T	U	(# above U) *	S Nail	M Nail
2550	2574	2598	2622	2646	2670	2694	2718	2742	2766	2790	2814	2838	2862	2886	2910	2934	24 (Riser) + 2934 (U)	N/A	N/A

S-7515-01

Clovis Lounge Chair

Width: 28.25 Depth: 34 Height: 39.75

AH: 24.5 SH: 19 SD: 20.5 IW: 22

Weight: 55 / 55 lbs Cube: 22.09

Standard Pillows: N/A Finish Req: N

Standard Cushions: Endurance Standard Finish: Mica

COM: 7.75 yards

Only available in Mica Finish.

D	E	F	G	H	J	K _{COM}	L	M	N	O	P	Q	R	S	T	U	(# above U) *	S Nail	M Nail
2085	2109	2133	2157	2181	2205	2229	2253	2277	2301	2325	2349	2373	2397	2421	2445	2469	24 (Riser) + 2469 (U)	N/A	N/A

S-7515-50

Clovis Sofa

Width: 74.25 Depth: 34 Height: 39.75

AH: 24.5 SH: 19 SD: 20.5 IW: 67.5

Weight: 108 / 108 lbs Cube: 58.07

Standard Pillows: N/A Finish Req: N

Standard Cushions: Endurance Standard Finish: Mica

COM: 11.75 yards

Only available in Mica Finish.

D	E	F	G	H	J	K _{COM}	L	M	N	O	P	Q	R	S	T	U	(# above U) *	S Nail	M Nail
2745	2781	2817	2853	2889	2925	2961	2997	3033	3069	3105	3141	3177	3213	3249	3285	3321	36 (Riser) + 3321 (U)	N/A	N/A

S-7518-01

Amelia Lounge Chair

Width: 39.5 Depth: 32.5 Height: 37

AH: 27 SH: 19.5 SD: 20.5 IW: 21.5

Weight: 90 / 100 lbs Cube: 35.12

Standard Pillows: N/A Finish Req: Y

Standard Cushions: Endurance Standard Finish: N/A

COM: 8.75 yards

D	E	F	G	H	J	K _{COM}	L	M	N	O	P	Q	R	S	T	U	(# above U) *	S Nail	M Nail
2385	2409	2433	2457	2481	2505	2529	2553	2577	2601	2625	2649	2673	2697	2721	2745	2769	24 (Riser) + 2769 (U)	45	60

S-7527-01

Cranford Lounge Chair

Width: 32.5 Depth: 32.5 Height: 36

AH: 27 SH: 19 SD: 19.5 IW: 20.5

Weight: 65 / 70 lbs Cube: 29.69

Standard Pillows: N/A Finish Req: Y

Standard Cushions: Endurance Standard Finish: N/A

COM: 7.25 yards

D	E	F	G	H	J	K _{COM}	L	M	N	O	P	Q	R	S	T	U	(# above U) *	S Nail	M Nail
2400	2421	2442	2463	2484	2505	2526	2547	2568	2589	2610	2631	2652	2673	2694	2715	2736	21 (Riser) + 2736 (U)	N/A	N/A

S-7529-01

Amanda Lounge Chair

Width: 32 Depth: 34 Height: 37

AH: 25.5 SH: 20 SD: 21 IW: 20

Weight: 55 / 65 lbs Cube: 29.29

Standard Pillows: N/A Finish Req: Y

Standard Cushions: Endurance Standard Finish: N/A

COM: 6.5 yards

D	E	F	G	H	J	K _{COM}	L	M	N	O	P	Q	R	S	T	U	(# above U) *	S Nail	M Nail
2310	2328	2346	2364	2382	2400	2418	2436	2454	2472	2490	2508	2526	2544	2562	2580	2598	18 (Riser) + 2598 (U)	45	60

UPHOLSTERY

S-7532-01

Standard Pillows: N/A **Finish Req:** Y
Standard Cushions: Endurance **Standard Finish:** N/A
COM: 6.75 yards

Smith Lounge Chair

Width: 34.5 **Depth:** 34.5 **Height:** 36.5
AH: 25 **SH:** 18.5 **SD:** 20 **IW:** 21.5
Weight: 65 / 75 lbs **Cube:** 29.29

D	E	F	G	H	J	K _{COM}	L	M	N	O	P	Q	R	S	T	U	(# above U) *	S Nail	M Nail
2262	2280	2298	2316	2334	2352	2370	2388	2406	2424	2442	2460	2478	2496	2514	2532	2550	18 (Riser) + 2550 (U)	45	60

S-7534-01

Standard Pillows: N/A **Finish Req:** Y
Standard Cushions: Endurance **Standard Finish:** N/A
COM: 8.75 yards

Lucas Lounge Chair

Width: 28.5 **Depth:** 28.5 **Height:** 34.5
AH: 26.5 **SH:** 20 **SD:** 19.5 **IW:** 21
Weight: 65 / 75 lbs **Cube:** 29.29

D	E	F	G	H	J	K _{COM}	L	M	N	O	P	Q	R	S	T	U	(# above U) *	S Nail	M Nail
2673	2697	2721	2745	2769	2793	2817	2841	2865	2889	2913	2937	2961	2985	3009	3033	3057	24 (Riser) + 3057 (U)	45	60

S-7537-01

Standard Pillows: N/A **Finish Req:** Y
Standard Cushions: Endurance **Standard Finish:** N/A
COM: 6.75 yards

Aaron Lounge Chair

Width: 34 **Depth:** 41 **Height:** 37.5
AH: 26 **SH:** 19 **SD:** 20 **IW:** 21
Weight: 45 / 55 lbs **Cube:** 29.69

D	E	F	G	H	J	K _{COM}	L	M	N	O	P	Q	R	S	T	U	(# above U) *	S Nail	M Nail
2445	2466	2487	2508	2529	2550	2571	2592	2613	2634	2655	2676	2697	2718	2739	2760	2781	21 (Riser) + 2781 (U)	90	105

S-7558-01

Standard Pillows: N/A **Finish Req:** Y
Standard Cushions: Endurance **Standard Finish:** N/A
COM: 7.25 yards

Ross Lounge Chair

Width: 30.5 **Depth:** 34.5 **Height:** 36
AH: 25.5 **SH:** 18.5 **SD:** 20 **IW:** 20.5
Weight: 60 / 75 lbs **Cube:** 29.29

D	E	F	G	H	J	K _{COM}	L	M	N	O	P	Q	R	S	T	U	(# above U) *	S Nail	M Nail
2340	2361	2382	2403	2424	2445	2466	2487	2508	2529	2550	2571	2592	2613	2634	2655	2676	21 (Riser) + 2676 (U)	45	N/A

S-7594-01

Standard Pillows: N/A **Finish Req:** Y
Standard Cushions: Endurance **Standard Finish:** N/A
COM: 5.5 yards

Drew Lounge Chair

Width: 28 **Depth:** 32 **Height:** 34
AH: 24 **SH:** 18.5 **SD:** 20 **IW:** 20
Weight: 40 / 50 lbs **Cube:** 23.22

D	E	F	G	H	J	K _{COM}	L	M	N	O	P	Q	R	S	T	U	(# above U) *	S Nail	M Nail
2220	2235	2250	2265	2280	2295	2310	2325	2340	2355	2370	2385	2400	2415	2430	2445	2460	15 (Riser) + 2460 (U)	75	90

S-7597-01

Standard Pillows: N/A **Finish Req:** Y
Standard Cushions: Endurance **Standard Finish:** N/A
COM: 6.25 yards

Faulkner Lounge Chair

Width: 31 **Depth:** 33.5 **Height:** 32.5
AH: 23 **SH:** 18 **SD:** 19.5 **IW:** 23
Weight: 59 / 73 lbs **Cube:** 29.69

D	E	F	G	H	J	K _{COM}	L	M	N	O	P	Q	R	S	T	U	(# above U) *	S Nail	M Nail
2400	2418	2436	2454	2472	2490	2508	2526	2544	2562	2580	2598	2616	2634	2652	2670	2688	18 (Riser) + 2688 (U)	N/A	N/A

S-7829-E1

Standard Pillows: N/A **Finish Req:** Y
Standard Cushions: High Resiliency 30 **Standard Finish:** N/A
COM: 6.25 yards
 Features an EasyClean Seat

Dianna EasyClean Wing Chair

Width: 28 **Depth:** 32 **Height:** 41
AH: 26 **SH:** 19 **SD:** 20 **IW:** 23
Weight: 70 / 80 lbs **Cube:** 26.89

D	E	F	G	H	J	K _{COM}	L	M	N	O	P	Q	R	S	T	U	(# above U) *	S Nail	M Nail
2235	2253	2271	2289	2307	2325	2343	2361	2379	2397	2415	2433	2451	2469	2487	2505	2523	18 (Riser) + 2523 (U)	60	75

UPHOLSTERY

S-7829-01

Dianna Wing Chair

Standard Pillows: N/A **Finish Req:** Y

Standard Cushions: Endurance **Standard Finish:** N/A

COM: 6 yards

Width: 27.5 **Depth:** 32 **Height:** 41.5

AH: 26.5 **SH:** 19.5 **SD:** 20 **IW:** 22.5

Weight: 51 / 67 lbs **Cube:** 27.3

D	E	F	G	H	J	K ^{COM}	L	M	N	O	P	Q	R	S	T	U	(# above U) *	S Nail	M Nail
2235	2253	2271	2289	2307	2325	2343	2361	2379	2397	2415	2433	2451	2469	2487	2505	2523	18 (Riser) + 2523 (U)	60	75

W-S252-05

WASHABLE SLIPCOVERS

Melrose Slipcovered Tall Side Chair

Standard Pillows: N/A **Finish Req:** N

Standard Cushions: High Resiliency 40 **Standard Finish:** Tobacco

COM: 6 yards

Frame is upholstered in muslin and includes a slipcover. Slipcover only available in the Washable Slipcover Program Fabrics. Not available in COM or FOM.

Width: 19.5 **Depth:** 27 **Height:** 41

AH: - **SH:** 20 **SD:** 19 **IW:** 19.5

Weight: 25 / 25 lbs **Cube:** 12.49

D	E	F	G	H	J	K ^{COM}	L	M	N	O	P	Q	R	S	T	U	(# above U) *	S Nail	M Nail
675	N/A	N/A	N/A	N/A	675	N/A	N/A	N/A	N/A	720	N/A	750	N/A	N/A	N/A	N/A	N/A (Riser) + N/A (U)	N/A	N/A

W-S252-05-C

WASHABLE SLIPCOVERS

Melrose Slipcover Only

Standard Pillows: N/A **Finish Req:** N

Standard Cushions: N/A **Standard Finish:** N/A

COM: 3.25 yards

A Slipcover only available in the Washable Slipcover Program Fabrics. Not available in COM or FOM.

Width: 19.5 **Depth:** 27 **Height:** 41

AH: - **SH:** 20 **SD:** 19 **IW:** 19.5

Weight: 20 / 20 lbs **Cube:** 12.49

D	E	F	G	H	J	K ^{COM}	L	M	N	O	P	Q	R	S	T	U	(# above U) *	S Nail	M Nail
210	N/A	N/A	N/A	N/A	210	N/A	N/A	N/A	N/A	255	N/A	255	N/A	N/A	N/A	N/A	N/A (Riser) + N/A (U)	N/A	N/A

LEATHER

L-B077-01

PELLE PROVISIONS
Sparta Lounge Chair

Standard Pillows: N/A **Finish Required:** N
Standard Cushions: High Resiliency 40 **Standard Finish:** Bronze
COL: 79 square feet
Only available in Bronze finish

Width: 30.5 **Depth:** 34.5 **Height:** 32
AH: 22 **SH:** 18 **SD:** 21 **IW:** 24
Weight: 60 / 74 lbs **Cube:** 29.69

1	2	3	4	5	6	8	COL	S Nail	M Nail
3345	3465	3585	3705	3825	3945	5040	2445	N/A	N/A

L-B078-01

PELLE PROVISIONS
Sparta Lounge Chair

Standard Pillows: N/A **Finish Required:** N
Standard Cushions: High Resiliency 40 **Standard Finish:** Bronze
COL: 79 square feet

Width: 30.5 **Depth:** 34.5 **Height:** 32
AH: 22 **SH:** 18 **SD:** 21 **IW:** 24
Weight: 60 / 73 lbs **Cube:** 29.69

1	2	3	4	5	6	8	COL	S Nail	M Nail
3285	3405	3525	3645	3765	3885	4980	2445	N/A	N/A

L-B091-C6

Nolita Counter Stool

Standard Pillows: N/A **Finish Required:** N
Standard Cushions: High Resiliency 40 **Standard Finish:** Bronze
COL: 48.6 square feet
Only available in Bronze finish

Width: 28 **Depth:** 24.5 **Height:** 35.5
AH: 35.5 **SH:** 26 **SD:** 19 **IW:** 18
Weight: 34 / 47 lbs **Cube:** 14.09

1	2	3	4	5	6	8	COL	S Nail	M Nail
2550	2625	2700	2775	2850	2925	3600	1986	N/A	N/A

L-B091-01

Nolita Occasional Chair

Standard Pillows: N/A **Finish Required:** N
Standard Cushions: High Resiliency 40 **Standard Finish:** Bronze
COL: 51 square feet
Only available in Bronze finish

Width: 28 **Depth:** 24.5 **Height:** 28
AH: 28 **SH:** 19 **SD:** 19 **IW:** 18
Weight: 32 / 45 lbs **Cube:** 11.11

1	2	3	4	5	6	8	COL	S Nail	M Nail
2445	2520	2595	2670	2745	2820	3525	1911	N/A	N/A

L-B091-06

Nolita Bar Stool

Standard Pillows: N/A **Finish Required:** N
Standard Cushions: High Resiliency 40 **Standard Finish:** Bronze
COL: 48.6 square feet
Only available in Bronze finish

Width: 28 **Depth:** 24.5 **Height:** 39.5
AH: 39.5 **SH:** 30 **SD:** 19 **IW:** 18
Weight: 34 / 47 lbs **Cube:** 15.68

1	2	3	4	5	6	8	COL	S Nail	M Nail
2550	2625	2700	2775	2850	2925	3600	1986	N/A	N/A

L-B098-C7

Ian Counter Stool

Standard Pillows: N/A **Finish Required:** N
Standard Cushions: High Resiliency 40 **Standard Finish:** Bronze
COL: 28.8 square feet
Only available in Bronze finish

Width: 21 **Depth:** 26 **Height:** 41
AH: - **SH:** 26 **SD:** 19.5 **IW:** 21
Weight: 23 / 37 lbs **Cube:** 19.6

1	2	3	4	5	6	8	COL	S Nail	M Nail
1995	2040	2085	2130	2175	2220	2625	1638	N/A	N/A

L-B098-05

Ian Side Chair

Standard Pillows: N/A **Finish Required:** N
Standard Cushions: High Resiliency 40 **Standard Finish:** Bronze
COL: 28.8 square feet
Only available in Bronze finish

Width: 21 **Depth:** 26 **Height:** 35.5
AH: - **SH:** 20.5 **SD:** 19.5 **IW:** 21
Weight: 23 / 36 lbs **Cube:** 11.21

1	2	3	4	5	6	8	COL	S Nail	M Nail
1950	1995	2040	2085	2130	2175	2580	1593	N/A	N/A

LEATHER

L-B098-07

Ian Bar Stool

Standard Pillows: N/A **Finish Required:** N
Standard Cushions: High Resilency 40 **Standard Finish:** Bronze
COL: 28.8 square feet
 Only available in Bronze finish

Width: 21 **Depth:** 26 **Height:** 45
AH: - **SH:** 30 **SD:** 19.5 **IW:** 21
Weight: 25 / 40 lbs **Cube:** 24.14

1 1995	2 2040	3 2085	4 2130	5 2175	6 2220	8 2625	COL 1638	S Nail N/A	M Nail N/A
-----------	-----------	-----------	-----------	-----------	-----------	-----------	-------------	---------------	---------------

L-B099-C7

Uma Counter Stool

Standard Pillows: N/A **Finish Required:** N
Standard Cushions: High Resilency 55 **Standard Finish:** Bronze
COL: 28.8 square feet
 Only available in Bronze finish

Width: 21 **Depth:** 26 **Height:** 41
AH: - **SH:** 26 **SD:** 19.5 **IW:** 21
Weight: 23 / 34 lbs **Cube:** 12.95

1 2115	2 2160	3 2205	4 2250	5 2295	6 2340	8 2745	COL 1638	S Nail N/A	M Nail N/A
-----------	-----------	-----------	-----------	-----------	-----------	-----------	-------------	---------------	---------------

L-B099-05

Uma Side Chair

Standard Pillows: N/A **Finish Required:** N
Standard Cushions: High Resilency 55 **Standard Finish:** Bronze
COL: 28.8 square feet
 Only available in Bronze finish

Width: 21 **Depth:** 26 **Height:** 35.5
AH: - **SH:** 20.5 **SD:** 19.5 **IW:** 21
Weight: 23 / 33 lbs **Cube:** 11.21

1 2040	2 2085	3 2130	4 2175	5 2220	6 2265	8 2670	COL 1593	S Nail N/A	M Nail N/A
-----------	-----------	-----------	-----------	-----------	-----------	-----------	-------------	---------------	---------------

L-B099-07

Uma Bar Stool

Standard Pillows: N/A **Finish Required:** N
Standard Cushions: High Resilency 55 **Standard Finish:** Bronze
COL: 28.8 square feet
 Only available in Bronze finish

Width: 21 **Depth:** 26 **Height:** 45
AH: - **SH:** 30 **SD:** 19.5 **IW:** 21
Weight: 25 / 38 lbs **Cube:** 14.21

1 2115	2 2160	3 2205	4 2250	5 2295	6 2340	8 2745	COL 1638	S Nail N/A	M Nail N/A
-----------	-----------	-----------	-----------	-----------	-----------	-----------	-------------	---------------	---------------

L-B100-C7

Ian Counter Stool

Standard Pillows: N/A **Finish Required:** N
Standard Cushions: High Resilency 40 **Standard Finish:** Bright Brass
COL: 28.8 square feet
 Only available in Bright Brass finish

Width: 21 **Depth:** 26 **Height:** 41
AH: - **SH:** 26 **SD:** 19.5 **IW:** 21
Weight: 23 / 37 lbs **Cube:** 12.95

1 2010	2 2055	3 2100	4 2145	5 2190	6 2235	8 2640	COL 1653	S Nail N/A	M Nail N/A
-----------	-----------	-----------	-----------	-----------	-----------	-----------	-------------	---------------	---------------

L-B100-05

Ian Side Chair

Standard Pillows: N/A **Finish Required:** N
Standard Cushions: High Resilency 40 **Standard Finish:** Bright Brass
COL: 28.8 square feet
 Only available in Bright Brass finish

Width: 21 **Depth:** 26 **Height:** 35.5
AH: - **SH:** 20.5 **SD:** 19.5 **IW:** 21
Weight: 23 / 33 lbs **Cube:** 11.21

1 1965	2 2010	3 2055	4 2100	5 2145	6 2190	8 2595	COL 1578	S Nail N/A	M Nail N/A
-----------	-----------	-----------	-----------	-----------	-----------	-----------	-------------	---------------	---------------

L-B101-C7

Uma Counter Stool

Standard Pillows: N/A **Finish Required:** N
Standard Cushions: High Resilency 55 **Standard Finish:** Bright Brass
COL: 28.8 square feet
 Only available in Bright Brass finish

Width: 21 **Depth:** 26 **Height:** 41
AH: - **SH:** 26 **SD:** 19.5 **IW:** 21
Weight: 23 / 34 lbs **Cube:** 12.95

1 2085	2 2130	3 2175	4 2220	5 2265	6 2310	8 2715	COL 1653	S Nail N/A	M Nail N/A
-----------	-----------	-----------	-----------	-----------	-----------	-----------	-------------	---------------	---------------

LEATHER

L-B101-05

Uma Side Chair

Standard Pillows: N/A Finish Required: N
 Standard Cushions: High Resilency 55 Standard Finish: Bright Brass
 COL: 28.8 square feet
 Only available in Bright Brass finish

Width: 21 Depth: 26 Height: 35.5
 AH: - SH: 20.5 SD: 19.5 IW: 21
 Weight: 23 / 33 lbs Cube: 11.21

1 2040	2 2085	3 2130	4 2175	5 2220	6 2265	8 2670	COL 1578	S Nail N/A	M Nail N/A
-----------	-----------	-----------	-----------	-----------	-----------	-----------	-------------	---------------	---------------

F000-C7-K

THE LEATHER RESERVE
 Nico Counter Stool

Standard Pillows: N/A Finish Required: N
 Standard Cushions: N/A Standard Finish: matte black
 COL: N/A
 Married in 1310-60 Black leather with decorative stitching on seat. Metal base.

Width: 18 Depth: 19.5 Height: 24
 AH: - SH: - SD: - IW: -
 Weight: 12 / 12 lbs Cube: 4.87

1 597	2 N/A	3 N/A	4 N/A	5 N/A	6 N/A	8 N/A	COL N/A	S Nail N/A	M Nail N/A
----------	----------	----------	----------	----------	----------	----------	------------	---------------	---------------

F000-C7-N

THE LEATHER RESERVE
 Nico Counter Stool

Standard Pillows: N/A Finish Required: N
 Standard Cushions: N/A Standard Finish: matte black
 COL: N/A
 Married in 1309-10 Brown leather with decorative stitching on seat. Metal base.

Width: 18 Depth: 19.5 Height: 24
 AH: - SH: - SD: - IW: -
 Weight: 12 / 12 lbs Cube: 4.87

1 597	2 N/A	3 N/A	4 N/A	5 N/A	6 N/A	8 N/A	COL N/A	S Nail N/A	M Nail N/A
----------	----------	----------	----------	----------	----------	----------	------------	---------------	---------------

F000-07-K

THE LEATHER RESERVE
 Nico Bar Stool

Standard Pillows: N/A Finish Required: N
 Standard Cushions: N/A Standard Finish: matte black
 COL: N/A
 Married in 1310-60 Black leather with decorative stitching on seat. Metal base.

Width: 18 Depth: 19.5 Height: 30
 AH: - SH: - SD: - IW: -
 Weight: 13 / 13 lbs Cube: 6.09

1 597	2 N/A	3 N/A	4 N/A	5 N/A	6 N/A	8 N/A	COL N/A	S Nail N/A	M Nail N/A
----------	----------	----------	----------	----------	----------	----------	------------	---------------	---------------

F000-07-N

THE LEATHER RESERVE
 Nico Bar Stool

Standard Pillows: N/A Finish Required: N
 Standard Cushions: N/A Standard Finish: matte black
 COL: N/A
 Married in 1309-10 Brown leather with decorative stitching on seat. Metal base.

Width: 18 Depth: 19.5 Height: 30
 AH: - SH: - SD: - IW: -
 Weight: 13 / 13 lbs Cube: 6.09

1 597	2 N/A	3 N/A	4 N/A	5 N/A	6 N/A	8 N/A	COL N/A	S Nail N/A	M Nail N/A
----------	----------	----------	----------	----------	----------	----------	------------	---------------	---------------

F001-C7-K

THE LEATHER RESERVE
 Nadia Counter Stool

Standard Pillows: N/A Finish Required: N
 Standard Cushions: N/A Standard Finish: matte black
 COL: N/A
 Married in 1310-60 Black leather with decorative stitching on seat. Metal base.

Width: 19.5 Depth: 20.5 Height: 37
 AH: - SH: 24.5 SD: 17 IW: 19.5
 Weight: 16 / 16 lbs Cube: 8.55

1 837	2 N/A	3 N/A	4 N/A	5 N/A	6 N/A	8 N/A	COL N/A	S Nail N/A	M Nail N/A
----------	----------	----------	----------	----------	----------	----------	------------	---------------	---------------

F001-C7-N

THE LEATHER RESERVE
 Nadia Counter Stool

Standard Pillows: N/A Finish Required: N
 Standard Cushions: N/A Standard Finish: matte black
 COL: N/A
 Married in 1309-10 Brown leather with decorative stitching on seat. Metal base.

Width: 19.5 Depth: 20.5 Height: 37
 AH: - SH: 24.5 SD: 17 IW: 19.5
 Weight: 16 / 16 lbs Cube: 8.55

1 837	2 N/A	3 N/A	4 N/A	5 N/A	6 N/A	8 N/A	COL N/A	S Nail N/A	M Nail N/A
----------	----------	----------	----------	----------	----------	----------	------------	---------------	---------------

LEATHER

F001-07-K

THE LEATHER RESERVE

Nadia Bar Stool

Width: 19.5 Depth: 20.5 Height: 43

AH: - SH: 30.5 SD: 17 IW: 19.5

Weight: 17 / 17 lbs Cube: 9.94

Standard Pillows: N/A Finish Required: N

Standard Cushions: N/A Standard Finish: matte black

COL: N/A

Married in 1310-60 Black leather with decorative stitching on seat. Metal base.

1	2	3	4	5	6	8	COL	S Nail	M Nail
837	N/A	N/A	N/A	N/A	N/A	N/A	N/A	N/A	N/A

F001-07-N

THE LEATHER RESERVE

Nadia Bar Stool

Width: 19.5 Depth: 20.5 Height: 43

AH: - SH: 30.5 SD: 17 IW: 19.5

Weight: 17 / 17 lbs Cube: 9.94

Standard Pillows: N/A Finish Required: N

Standard Cushions: N/A Standard Finish: matte black

COL: N/A

Married in 1309-10 Brown leather with decorative stitching on seat. Metal base.

1	2	3	4	5	6	8	COL	S Nail	M Nail
837	N/A	N/A	N/A	N/A	N/A	N/A	N/A	N/A	N/A

F002-C7-K

THE LEATHER RESERVE

Luca Counter Stool

Width: 18.75 Depth: 23.5 Height: 39

AH: - SH: - SD: 17 IW: 18.75

Weight: 19 / 19 lbs Cube: 9.94

Standard Pillows: N/A Finish Required: N

Standard Cushions: N/A Standard Finish: matte black

COL: N/A

Married in 1310-60 Black leather with channeled upholstered seat. Mango wooden rails and decorative leather sling straps on the seating. Metal base.

1	2	3	4	5	6	8	COL	S Nail	M Nail
987	N/A	N/A	N/A	N/A	N/A	N/A	N/A	N/A	N/A

F002-C7-N

THE LEATHER RESERVE

Luca Counter Stool

Width: 18.75 Depth: 23.5 Height: 39

AH: - SH: - SD: 17 IW: 18.75

Weight: 19 / 19 lbs Cube: 9.94

Standard Pillows: N/A Finish Required: N

Standard Cushions: N/A Standard Finish: matte black

COL: N/A

Married in 1309-10 Brown leather with channeled upholstered seat. Mango wooden rails and decorative leather sling straps on the seating. Metal base.

1	2	3	4	5	6	8	COL	S Nail	M Nail
987	N/A	N/A	N/A	N/A	N/A	N/A	N/A	N/A	N/A

F002-07-K

THE LEATHER RESERVE

Luca Bar Stool

Width: 18.75 Depth: 23.5 Height: 42.5

AH: - SH: 30 SD: 17 IW: 18.75

Weight: 20 / 20 lbs Cube: 10.83

Standard Pillows: N/A Finish Required: N

Standard Cushions: N/A Standard Finish: matte black

COL: N/A

Married in 1310-60 Black leather with channeled upholstered seat. Mango wooden rails and decorative leather sling straps on the seating. Metal base.

1	2	3	4	5	6	8	COL	S Nail	M Nail
987	N/A	N/A	N/A	N/A	N/A	N/A	N/A	N/A	N/A

F002-07-N

THE LEATHER RESERVE

Luca Bar Stool

Width: 18.75 Depth: 23.5 Height: 42.5

AH: - SH: 30 SD: 17 IW: 18.75

Weight: 20 / 20 lbs Cube: 10.83

Standard Pillows: N/A Finish Required: N

Standard Cushions: N/A Standard Finish: matte black

COL: N/A

Married in 1309-10 Brown leather with channeled upholstered seat. Mango wooden rails and decorative leather sling straps on the seating. Metal base.

1	2	3	4	5	6	8	COL	S Nail	M Nail
987	N/A	N/A	N/A	N/A	N/A	N/A	N/A	N/A	N/A

F005-31

THE LEATHER RESERVE

Iman Swivel Chair

Width: 33 Depth: 35 Height: 30.75

AH: 24 SH: 19 SD: 22 IW: 22

Weight: 88 / 88 lbs Cube: 20.55

Standard Pillows: N/A Finish Required: N

Standard Cushions: Classic Plush Standard Finish: Tobacco

COL: N/A

Married in 1306 67 Pewter with Brushed Nickel nail trim

1	2	3	4	5	6	8	COL	S Nail	M Nail
2397	N/A	N/A	N/A	N/A	N/A	N/A	N/A	N/A	N/A

LEATHER

F006-PR-D

THE LEATHER RESERVE

Hailey Power Recliner

With Power Articulating Headrest

Width: 34.5 Depth: 39 Height: 42

AH: 24 SH: 20 SD: 20 IW: 23 Recl D: 66.5 TV Recl: 56.5 Wall Clr: 4

Weight: 137 / 137 lbs Cube: 32.7

Standard Pillows: N/A Finish Required: N

Standard Cushions: High Resiliency 35 Standard Finish: N/A

COL: N/A

Married in 1304 90 Denim Leather with Brushed Nickel nail trim.

1 2697	2 N/A	3 N/A	4 N/A	5 N/A	6 N/A	8 N/A	COL N/A	S Nail N/A	M Nail N/A
-----------	----------	----------	----------	----------	----------	----------	------------	---------------	---------------

F006-PR-I

THE LEATHER RESERVE

Hailey Power Recliner

With Power Articulating Headrest

Width: 34.5 Depth: 39 Height: 42

AH: 24 SH: 20 SD: 20 IW: 23 Recl D: 66.5 TV Recl: 56.5 Wall Clr: 4

Weight: 137 / 137 lbs Cube: 32.7

Standard Pillows: N/A Finish Required: N

Standard Cushions: High Resiliency 35 Standard Finish: N/A

COL: N/A

Married in 1304 70 Ivory Leather with Brushed Nickel nail trim

1 2697	2 N/A	3 N/A	4 N/A	5 N/A	6 N/A	8 N/A	COL N/A	S Nail N/A	M Nail N/A
-----------	----------	----------	----------	----------	----------	----------	------------	---------------	---------------

F006-PS-D

THE LEATHER RESERVE

Hailey Power Left and Right Reclining Sofa

With Power Articulating Headrest

Width: 81.5 Depth: 38.5 Height: 42

AH: 24 SH: 20 SD: 20 IW: 70 Recl D: 67 TV Recl: 56 Wall Clr: 5.75

Weight: 291 / 291 lbs Cube: 76.26

Standard Pillows: N/A Finish Required: N

Standard Cushions: High Resiliency 35 Standard Finish: N/A

COL: N/A

Married in 1304 90 Denim Leather with Brushed Nickel nail trim.

1 5097	2 N/A	3 N/A	4 N/A	5 N/A	6 N/A	8 N/A	COL N/A	S Nail N/A	M Nail N/A
-----------	----------	----------	----------	----------	----------	----------	------------	---------------	---------------

F006-PS-I

THE LEATHER RESERVE

Hailey Power Left and Right Reclining Sofa

With Power Articulating Headrest

Width: 81.5 Depth: 38.5 Height: 42

AH: 24 SH: 20 SD: 20 IW: 70 Recl D: 67 TV Recl: 56 Wall Clr: 5.75

Weight: 291 / 291 lbs Cube: 76.26

Standard Pillows: N/A Finish Required: N

Standard Cushions: High Resiliency 35 Standard Finish: N/A

COL: N/A

Married in 1304 70 Ivory Leather with Brushed Nickel nail trim

1 5097	2 N/A	3 N/A	4 N/A	5 N/A	6 N/A	8 N/A	COL N/A	S Nail N/A	M Nail N/A
-----------	----------	----------	----------	----------	----------	----------	------------	---------------	---------------

F007-PR-C

THE LEATHER RESERVE

Ashley Power Recliner

With Power Articulating Headrest

Width: 33.5 Depth: 39.5 Height: 41

AH: 24 SH: 18.75 SD: 21 IW: 23 Recl D: 67 TV Recl: 58 Wall Clr: 5

Weight: 152 / 152 lbs Cube: 31.39

Standard Pillows: N/A Finish Required: N

Standard Cushions: High Resiliency 35 Standard Finish: N/A

COL: N/A

Married in 1301 Slope Leather. Also available in F007-PR-K 1302 Khaki.

1 2997	2 N/A	3 N/A	4 N/A	5 N/A	6 N/A	8 N/A	COL N/A	S Nail N/A	M Nail N/A
-----------	----------	----------	----------	----------	----------	----------	------------	---------------	---------------

F007-PR-K

THE LEATHER RESERVE

Ashley Power Recliner

With Power Articulating Headrest

Width: 33.5 Depth: 39.5 Height: 41

AH: 24 SH: 18.75 SD: 21 IW: 23 Recl D: 67 TV Recl: 58 Wall Clr: 5

Weight: 152 / 152 lbs Cube: 31.39

Standard Pillows: N/A Finish Required: N

Standard Cushions: High Resiliency 35 Standard Finish: N/A

COL: N/A

Married in 1302 Khaki Leather. Also available in F007-PR-C 1301 Slope.

1 2997	2 N/A	3 N/A	4 N/A	5 N/A	6 N/A	8 N/A	COL N/A	S Nail N/A	M Nail N/A
-----------	----------	----------	----------	----------	----------	----------	------------	---------------	---------------

F007-PS-C

THE LEATHER RESERVE

Ashley Power Left and Right Reclining Sofa

With Power Articulating Headrest

Width: 80.5 Depth: 40 Height: 42

AH: 24 SH: 18 SD: 20 IW: 70 Recl D: 66.5 TV Recl: 55 Wall Clr: 5.75

Weight: 300 / 300 lbs Cube: 78.26

Standard Pillows: N/A Finish Required: N

Standard Cushions: High Resiliency 35 Standard Finish: N/A

COL: N/A

Married in 1301 Slope Leather. Also available in F007-PS-K 1302 Khaki.

1 5697	2 N/A	3 N/A	4 N/A	5 N/A	6 N/A	8 N/A	COL N/A	S Nail N/A	M Nail N/A
-----------	----------	----------	----------	----------	----------	----------	------------	---------------	---------------

LEATHER

F007-PS-K

THE LEATHER RESERVE

Ashley Power Left and Right Reclining Sofa

With Power Articulating Headrest

Width: 80.5 Depth: 40 Height: 42

AH: 24 SH: 18 SD: 20 IW: 70 Recl D: 66.5 TV Recl: 55 Wall Clr: 5.75

Weight: 300 / 300 lbs Cube: 78.26

Standard Pillows: N/A Finish Required: N

Standard Cushions: High Resiliency 35 Standard Finish: N/A

COL: N/A

Married in 1302 Khaki Leather. Also available in F007-PS-C 1301 Slope.

1 5697	2 N/A	3 N/A	4 N/A	5 N/A	6 N/A	8 N/A	COL N/A	S Nail N/A	M Nail N/A
-----------	----------	----------	----------	----------	----------	----------	------------	---------------	---------------

F008-PR

THE LEATHER RESERVE

Karlie Power Recliner

With Power Articulating Headrest

Width: 28.5 Depth: 36 Height: 42

AH: 24 SH: 19.75 SD: 19 IW: 21.5 Recl D: 66 TV Recl: 60 Wall Clr: 17.25

Weight: 152 / 152 lbs Cube: 24.93

Standard Pillows: N/A Finish Required: N

Standard Cushions: High Resiliency 35 Standard Finish: Tobacco

COL: N/A

Married in 1300 71 Linen Leather

1 2697	2 N/A	3 N/A	4 N/A	5 N/A	6 N/A	8 N/A	COL N/A	S Nail N/A	M Nail N/A
-----------	----------	----------	----------	----------	----------	----------	------------	---------------	---------------

F009-PR

THE LEATHER RESERVE

Claudia Power Recliner

With Power Articulating Headrest

Width: 28.5 Depth: 37 Height: 42

AH: 24 SH: 20 SD: 19.5 IW: 21 Recl D: 66 TV Recl: 60 Wall Clr: 16.5

Weight: 115 / 115 lbs Cube: 25.63

Standard Pillows: N/A Finish Required: N

Standard Cushions: High Resiliency 35 Standard Finish: Tobacco

COL: N/A

Married in 1301 Cliff Leather

1 2697	2 N/A	3 N/A	4 N/A	5 N/A	6 N/A	8 N/A	COL N/A	S Nail N/A	M Nail N/A
-----------	----------	----------	----------	----------	----------	----------	------------	---------------	---------------

F014-PR

THE LEATHER RESERVE

Adriana Power Recliner

With Power Articulating Headrest

Width: 30.5 Depth: 36 Height: 42

AH: 25.5 SH: 20 SD: 19 IW: 21 Recl D: 67 TV Recl: 59 Wall Clr: 18

Weight: 131 / 131 lbs Cube: 26.68

Standard Pillows: N/A Finish Required: N

Standard Cushions: High Resiliency 35 Standard Finish: Tobacco

COL: N/A

Married in 1115 61 Charcoal with a woven braided trim detail.

1 2997	2 N/A	3 N/A	4 N/A	5 N/A	6 N/A	8 N/A	COL N/A	S Nail N/A	M Nail N/A
-----------	----------	----------	----------	----------	----------	----------	------------	---------------	---------------

F015-31

THE LEATHER RESERVE

Gisele Swivel Chair

Width: 29 Depth: 32.5 Height: 34.75

AH: 23.25 SH: 19 SD: 21.5 IW: 22

Weight: 115 / 115 lbs Cube: 18.95

Standard Pillows: N/A Finish Required: N

Standard Cushions: High Resiliency 35 Standard Finish: N/A

COL: N/A

Married in 1307 10 Oak. Features a flanged leather trim detail and large pleated inside back and inside arm.

1 2097	2 N/A	3 N/A	4 N/A	5 N/A	6 N/A	8 N/A	COL N/A	S Nail N/A	M Nail N/A
-----------	----------	----------	----------	----------	----------	----------	------------	---------------	---------------

F016-PR

THE LEATHER RESERVE

Naomi Power Recliner

With Power Articulating Headrest

Width: 28 Depth: 37.5 Height: 42

AH: 26 SH: 21 SD: 21 IW: 21 Recl D: 67 TV Recl: 62 Wall Clr: 17.5

Weight: 117 / 117 lbs Cube: 25.52

Standard Pillows: N/A Finish Required: N

Standard Cushions: High Resiliency 35 Standard Finish: Tobacco

COL: N/A

Married in 1303 68 Pewter Leather

1 2697	2 N/A	3 N/A	4 N/A	5 N/A	6 N/A	8 N/A	COL N/A	S Nail N/A	M Nail N/A
-----------	----------	----------	----------	----------	----------	----------	------------	---------------	---------------

F023-31

THE LEATHER RESERVE

Miranda Swivel Chair

Width: 32 Depth: 33 Height: 34.25

AH: 27 SH: 21 SD: 21.5 IW: 21.5

Weight: 115 / 115 lbs Cube: 20.93

Standard Pillows: N/A Finish Required: N

Standard Cushions: Classic Plush Standard Finish: N/A

COL: N/A

Married in 1308 72 Pearl Leather. Features a diamond quilted outarm and outback detail.

1 2397	2 N/A	3 N/A	4 N/A	5 N/A	6 N/A	8 N/A	COL N/A	S Nail N/A	M Nail N/A
-----------	----------	----------	----------	----------	----------	----------	------------	---------------	---------------

LEATHER

F600-C6-B

BD COLLECTION FOR FAIRFIELD

Warner Leather Counter Stool

Width: 21 Depth: 23 Height: 42.5

AH: 32 SH: 27 SD: 19 IW: 14

Weight: 24 / 24 lbs Cube: 11.87

Standard Pillows: N/A Finish Required: N

Standard Cushions: High Resiliency 40 Standard Finish: Black

COL: N/A square feet

Married in a chocolate faux leather with black powder coat finish.

1 1797	2 N/A	3 N/A	4 N/A	5 N/A	6 N/A	8 N/A	COL N/A	S Nail N/A	M Nail N/A
-----------	----------	----------	----------	----------	----------	----------	------------	---------------	---------------

F600-04-B

BD COLLECTION FOR FAIRFIELD

Warner Leather Dining Chair

Width: 22.5 Depth: 23.5 Height: 36.5

AH: 25.5 SH: 19 SD: 19.5 IW: 20.5

Weight: 31 / 31 lbs Cube: 11.16

Standard Pillows: N/A Finish Required: N

Standard Cushions: High Resiliency 40 Standard Finish: Black

COL: N/A square feet

Married in a chocolate faux leather with black powder coat finish.

1 1497	2 N/A	3 N/A	4 N/A	5 N/A	6 N/A	8 N/A	COL N/A	S Nail N/A	M Nail N/A
-----------	----------	----------	----------	----------	----------	----------	------------	---------------	---------------

L-N077-01

YOUR CHOICE LEATHER

Sparta Lounge Chair

Width: 30.5 Depth: 34.5 Height: 32

AH: 22 SH: 18 SD: 21 IW: 24

Weight: 60 / 74 lbs Cube: 19.48

Standard Pillows: N/A Finish Required: N

Standard Cushions: High Resiliency 40 Standard Finish: Nickel

COL: 90.95 square feet

Only available in Nickel finish

1 3360	2 3495	3 3630	4 3765	5 3900	6 4035	8 5295	COL 2445	S Nail N/A	M Nail N/A
-----------	-----------	-----------	-----------	-----------	-----------	-----------	-------------	---------------	---------------

L-N078-01

Sparta Lounge Chair

Width: 30.5 Depth: 34.5 Height: 32

AH: 22 SH: 18 SD: 21 IW: 24

Weight: 60 / 74 lbs Cube: 29.69

Standard Pillows: N/A Finish Required: N

Standard Cushions: High Resiliency 40 Standard Finish: Nickel

COL: 79 square feet

1 3465	2 3585	3 3705	4 3825	5 3945	6 4065	8 5160	COL 2445	S Nail N/A	M Nail N/A
-----------	-----------	-----------	-----------	-----------	-----------	-----------	-------------	---------------	---------------

L-N098-M7

Uma Billiard Bar Stool

Width: 21 Depth: 26 Height: 42.5

AH: - SH: 25.5 SD: 20 IW: -

Weight: 36 / 47 lbs Cube: 13.42

Standard Pillows: N/A Finish Required: N

Standard Cushions: High Resiliency 40 Standard Finish: Nickel

COL: 28.8 square feet

Only available in Nickel finish with standard gas lift

1 2475	2 2520	3 2565	4 2610	5 2655	6 2700	8 3105	COL 2073	S Nail N/A	M Nail N/A
-----------	-----------	-----------	-----------	-----------	-----------	-----------	-------------	---------------	---------------

L-N099-M7

Uma Billiard Bar Stool

Width: 21 Depth: 26 Height: 42.5

AH: - SH: 25.5 SD: 20 IW: -

Weight: 36 / 47 lbs Cube: 13.42

Standard Pillows: N/A Finish Required: N

Standard Cushions: High Resiliency 40 Standard Finish: Nickel

COL: 28.8 square feet

Only available in Nickel finish with standard gas lift

1 2595	2 2640	3 2685	4 2730	5 2775	6 2820	8 3225	COL 2073	S Nail N/A	M Nail N/A
-----------	-----------	-----------	-----------	-----------	-----------	-----------	-------------	---------------	---------------

L-1003-01

PELLE PROVISIONS

Blythe Lounge Chair

Leather

Width: 31 Depth: 32 Height: 35

AH: 24 SH: 19 SD: 21 IW: 23

Weight: 33 / 33 lbs Cube: 20.09

Standard Pillows: N/A Finish Required: Y

Standard Cushions: High Resiliency 40 Standard Finish: N/A

COL: 68 square feet

1 2475	2 2580	3 2685	4 2790	5 2895	6 3000	8 3945	COL 1746	S Nail 90	M Nail N/A
-----------	-----------	-----------	-----------	-----------	-----------	-----------	-------------	--------------	---------------

LEATHER

L-1010-35

PELLE PROVISIONS

Chrysler Office Swivel Chair

Standard Pillows: N/A Finish Required: N

Standard Cushions: High Resiliency 35 Standard Finish: Nickel

COL: 79 square feet

Standard with a gas lift and a locking tilt mechanism. Only available in Leather.

Width: 27.5 Depth: 28 Height: 43

AH: - SH: - SD: 19 IW: 20.25

Weight: 74 / 87 lbs Cube: 21.65

1	2	3	4	5	6	8	COL	S Nail	M Nail
3615	3735	3855	3975	4095	4215	5235	N/A	N/A	N/A

L-1015-05

Clark Side Chair

Standard Pillows: N/A Finish Required: Y

Standard Cushions: High Resiliency 40 Standard Finish: N/A

COL: 48.6 square feet

Width: 19.5 Depth: 26 Height: 40

AH: - SH: 20 SD: 18 IW: 20

Weight: 25 / 35 lbs Cube: 11.73

1	2	3	4	5	6	8	COL	S Nail	M Nail
1815	1890	1965	2040	2115	2190	2865	1197	45	60

L-1019-A4

Thayer Occasional Chair

Standard Pillows: N/A Finish Required: Y

Standard Cushions: High Resiliency 40 Standard Finish: N/A

COL: 38.7 square feet

Width: 24.5 Depth: 23 Height: 30

AH: 24.5 SH: 18.5 SD: 18 IW: 19.5

Weight: 25 / 35 lbs Cube: 9.78

1	2	3	4	5	6	8	COL	S Nail	M Nail
1815	1875	1935	1995	2055	2115	2655	1248	Std.	N/A

L-1019-01

Thayer Occasional Chair

Standard Pillows: N/A Finish Required: Y

Standard Cushions: High Resiliency 40 Standard Finish: N/A

COL: 38.7 square feet

Width: 24.5 Depth: 23 Height: 30

AH: 24.5 SH: 18.5 SD: 18 IW: 19.5

Weight: 25 / 30 lbs Cube: 9.78

1	2	3	4	5	6	8	COL	S Nail	M Nail
1725	1785	1845	1905	1965	2025	2565	1248	Std.	N/A

L-1021-04

Bedford Arm Chair

Standard Pillows: N/A Finish Required: Y

Standard Cushions: High Resiliency 40 Standard Finish: N/A

COL: 53.1 square feet

Width: 24 Depth: 25.5 Height: 40

AH: 25.5 SH: 20 SD: 18 IW: 20.5

Weight: 25 / 40 lbs Cube: 14.16

1	2	3	4	5	6	8	COL	S Nail	M Nail
1980	2070	2160	2250	2340	2430	3165	1377	45	60

L-1021-05

Bedford Side Chair

Standard Pillows: N/A Finish Required: Y

Standard Cushions: High Resiliency 40 Standard Finish: N/A

COL: 53.1 square feet

Width: 22.5 Depth: 25.5 Height: 40

AH: - SH: 20 SD: 18 IW: 22.5

Weight: 30 / 41 lbs Cube: 13.28

1	2	3	4	5	6	8	COL	S Nail	M Nail
1947	2037	2127	2217	2307	2397	3132	1347	60	75

L-1029-35

PELLE PROVISIONS

Eaton Office Swivel Chair

Standard Pillows: N/A Finish Required: Y

Standard Cushions: High Resiliency 40 Standard Finish: N/A

COL: 51 square feet

Standard with a gas lift.

Width: 25 Depth: 30.5 Height: 40.5

AH: - SH: - SD: 20 IW: 20

Weight: 65 / 75 lbs Cube: 26.89

1	2	3	4	5	6	8	COL	S Nail	M Nail
2520	2595	2670	2745	2820	2895	3600	1941	N/A	N/A

LEATHER

L-1032-35

PELLE PROVISIONS

Gherkin Office Swivel Chair

Width: 27 Depth: 28 Height: 39.5

AH: - SH: - SD: 19.5 IW: 20

Weight: 50 / 63 lbs Cube: 21.65

Standard Pillows: N/A Finish Required: N

Standard Cushions: High Resiliency 30 Standard Finish: Nickel

COL: 62 square feet

Standard with a gas lift and a locking tilt mechanism. Only available in Leather.

1	2	3	4	5	6	8	COL	S Nail	M Nail
3225	3330	3435	3540	3645	3750	4605	N/A	N/A	N/A

L-1046-35

PELLE PROVISIONS

Plaza 66 Office Swivel Chair

Width: 28.25 Depth: 31.75 Height: 43

AH: - SH: - SD: 20.75 IW: 19.5

Weight: 71 / 81 lbs Cube: 22.31

Standard Pillows: N/A Finish Required: N

Standard Cushions: Ultra Plush Standard Finish: Nickel

COL: 62 square feet

Standard with a gas lift and a locking tilt mechanism.

1	2	3	4	5	6	8	COL	S Nail	M Nail
3135	3240	3345	3450	3555	3660	4515	2391	Std.	N/A

L-1049-35

PELLE PROVISIONS

Taft Office Swivel Chair

Width: 24.5 Depth: 30.5 Height: 36

AH: - SH: - SD: 22 IW: 20

Weight: 50 / 60 lbs Cube: 21.65

Standard Pillows: N/A Finish Required: Y

Standard Cushions: High Resiliency 40 Standard Finish: N/A

COL: 51 square feet

Standard with a gas lift.

1	2	3	4	5	6	8	COL	S Nail	M Nail
2640	2715	2790	2865	2940	3015	3720	2037	Std.	N/A

L-1059-35

PELLE PROVISIONS

Stanford Office Swivel Chair

Width: 25 Depth: 31 Height: 36.5

AH: - SH: - SD: 21 IW: 19

Weight: 55 / 65 lbs Cube: 21.65

Standard Pillows: N/A Finish Required: Y

Standard Cushions: High Resiliency 40 Standard Finish: N/A

COL: 62 square feet

Standard with a gas lift.

1	2	3	4	5	6	8	COL	S Nail	M Nail
2895	3000	3105	3210	3315	3420	4275	2037	Std.	N/A

L-1082-A4

Addison Occasional Chair

Width: 24.5 Depth: 28.5 Height: 40.5

AH: 26.5 SH: 19.5 SD: 19.5 IW: 20

Weight: 30 / 35 lbs Cube: 16.36

Standard Pillows: N/A Finish Required: Y

Standard Cushions: High Resiliency 40 Standard Finish: N/A

COL: 48.6 square feet

1	2	3	4	5	6	8	COL	S Nail	M Nail
2064	2139	2214	2289	2364	2439	3114	1392	45	60

L-1082-01

Addison Occasional Chair

Width: 24.5 Depth: 28.5 Height: 40.5

AH: 26.5 SH: 19.5 SD: 19.5 IW: 20

Weight: 30 / 35 lbs Cube: 16.36

Standard Pillows: N/A Finish Required: Y

Standard Cushions: High Resiliency 40 Standard Finish: N/A

COL: 48.6 square feet

1	2	3	4	5	6	8	COL	S Nail	M Nail
1980	2055	2130	2205	2280	2355	3030	1392	45	60

L-1083-35

PELLE PROVISIONS

Wendell Office Swivel Chair

Width: 30 Depth: 35.5 Height: 46.5

AH: - SH: - SD: 18 IW: 19.5

Weight: 85 / 101 lbs Cube: 27.3

Standard Pillows: N/A Finish Required: Y

Standard Cushions: High Resiliency 30 Standard Finish: N/A

COL: 107 square feet

Standard with a gas lift.

1	2	3	4	5	6	8	COL	S Nail	M Nail
4275	4440	4605	4770	4935	5100	6570	3039	Std.	N/A

LEATHER

L-1087-35

PELLE PROVISIONS

Empire Office Swivel Chair

Width: 26.5 Depth: 27 Height: 42.5

AH: - SH: - SD: 20 IW: 19

Weight: 73 / 86 lbs Cube: 21.65

Standard Pillows: N/A Finish Required: N

Standard Cushions: High Resiliency 40 Standard Finish: Nickel

COL: 62 square feet

Standard with a gas lift and a locking tilt mechanism.

1	2	3	4	5	6	8	COL	S Nail	M Nail
2730	2835	2940	3045	3150	3255	4110	2031	N/A	N/A

L-1088-35

PELLE PROVISIONS

Somerset Office Swivel Chair

Width: 28 Depth: 31 Height: 0

AH: - SH: - SD: 20.5 IW: 19

Weight: 35 / 48 lbs Cube: 23.89

Standard Pillows: N/A Finish Required: Y

Standard Cushions: High Resiliency 40 Standard Finish: N/A

COL: 79 square feet

Standard with a gas lift.

1	2	3	4	5	6	8	COL	S Nail	M Nail
3300	3420	3540	3660	3780	3900	4995	2355	Std.	N/A

L-1138-01

Tipsy Lounge Chair

Wooden Base

Width: 28.75 Depth: 32 Height: 30.25

AH: 25 SH: 19 SD: 22.5 IW: 22

Weight: 72 / 85 lbs Cube: 23.89

Standard Pillows: N/A Finish Required: Y

Standard Cushions: Ultra Plush Standard Finish: N/A

COL: 85 square feet

1	2	3	4	5	6	8	COL	S Nail	M Nail
3201	3336	3471	3606	3741	3876	5046	2220	60	75

L-1139-01

Tipsy Lounge Chair

Wooden Base

Width: 28.75 Depth: 31 Height: 30.25

AH: 25.5 SH: 19 SD: 22 IW: 21.25

Weight: 59 / 71 lbs Cube: 23.89

Standard Pillows: N/A Finish Required: Y

Standard Cushions: Ultra Plush Standard Finish: N/A

COL: 102 square feet

1	2	3	4	5	6	8	COL	S Nail	M Nail
3531	3696	3861	4026	4191	4356	5766	2445	60	75

L-1139-31

PELLE PROVISIONS

Tipsy Swivel Chair

Width: 28.75 Depth: 31 Height: 30.25

AH: 25.5 SH: 19 SD: 22 IW: 21.25

Weight: 59 / 72 lbs Cube: 23.89

Standard Pillows: N/A Finish Required: Y

Standard Cushions: Ultra Plush Standard Finish: N/A

COL: 85 square feet

1	2	3	4	5	6	8	COL	S Nail	M Nail
3615	3750	3885	4020	4155	4290	5460	2550	60	75

L-1167-01

Asher Lounge Chair

Width: 31 Depth: 29 Height: 27

AH: 27 SH: 17.5 SD: 25.5 IW: 23

Weight: 93 / 106 lbs Cube: 14.04

Standard Pillows: N/A Finish Required: Y

Standard Cushions: High Resiliency 40 Standard Finish: N/A

COL: 96 square feet

1	2	3	4	5	6	8	COL	S Nail	M Nail
3465	3615	3765	3915	4065	4215	5535	2418	45	60

L-1167-31

Asher Swivel Chair

Width: 31 Depth: 29 Height: 27

AH: 27 SH: 17.5 SD: 25.5 IW: 23

Weight: 95 / 106 lbs Cube: 14.04

Standard Pillows: N/A Finish Required: Y

Standard Cushions: High Resiliency 40 Standard Finish: N/A

COL: 96 square feet

1	2	3	4	5	6	8	COL	S Nail	M Nail
3555	3705	3855	4005	4155	4305	5625	2493	45	60

LEATHER

L-1401-05

PELLE PROVISIONS

Socrates Barrell Back Dining Chair

with Casters

Width: 24 Depth: 24 Height: 31.5

AH: - SH: 19.5 SD: 20 IW: 20

Weight: 29 / 29 lbs Cube: 10.5

Standard Pillows: N/A Finish Required: N

Standard Cushions: High Resiliency 35 Standard Finish: N/A

COL: 79 square feet

Features six concealed casters.

1	2	3	4	5	6	8	COL	S Nail	M Nail
2355	2475	2595	2715	2835	2955	4050	1296	60	N/A

L-1402-05

PELLE PROVISIONS

Aristotle Barrell Back Dining Chair

with Casters

Width: 24 Depth: 24 Height: 31.5

AH: - SH: 19.5 SD: 20 IW: 20

Weight: 29 / 29 lbs Cube: 10.5

Standard Pillows: N/A Finish Required: N

Standard Cushions: High Resiliency 35 Standard Finish: N/A

COL: 74 square feet

Features six concealed casters.

1	2	3	4	5	6	8	COL	S Nail	M Nail
2355	2475	2595	2715	2835	2955	3975	1296	60	N/A

L-1431-01

PELLE PROVISIONS

Chapman Lounge Chair

Width: 30.5 Depth: 32.25 Height: 35.75

AH: 23.25 SH: 19.25 SD: 21.25 IW: 22.5

Weight: 48 / 63 lbs Cube: 23.89

Standard Pillows: N/A Finish Required: Y

Standard Cushions: High Resiliency 30 Standard Finish: N/A

COL: 85 square feet

1	2	3	4	5	6	8	COL	S Nail	M Nail
3135	3270	3405	3540	3675	3810	4980	2220	75	90

L-1435-01

PELLE PROVISIONS

La Brea Occasional Chair

Leather

Width: 27 Depth: 33.75 Height: 33.5

AH: 24 SH: 20.5 SD: 20 IW: 23.5

Weight: 34 / 34 lbs Cube: 17.66

Standard Pillows: N/A Finish Required: Y

Standard Cushions: Classic Plush Standard Finish: N/A

COL: 79 square feet

1	2	3	4	5	6	8	COL	S Nail	M Nail
2985	3105	3225	3345	3465	3585	4680	2205	120	N/A

L-1444-01

PELLE PROVISIONS

Edgeworth Wing Chair

Width: 32 Depth: 40 Height: 42.5

AH: 25 SH: 20.5 SD: 19 IW: 20.5

Weight: 65 / 81 lbs Cube: 34.38

Standard Pillows: N/A Finish Required: Y

Standard Cushions: Ultra Plush Standard Finish: N/A

COL: 124 square feet

1	2	3	4	5	6	8	COL	S Nail	M Nail
4290	4485	4680	4875	5070	5265	6975	2895	N/A	N/A

L-1444-20

PELLE PROVISIONS

Edgeworth Ottoman

Width: 23.5 Depth: 19.25 Height: 18

AH: - SH: - SD: - IW: -

Weight: 18 / 27 lbs Cube: 10.77

Standard Pillows: N/A Finish Required: Y

Standard Cushions: High Resiliency 30 Standard Finish: N/A

COL: 40 square feet

1	2	3	4	5	6	8	COL	S Nail	M Nail
1785	1845	1905	1965	2025	2085	2640	1257	N/A	N/A

L-1495-01

PELLE PROVISIONS

Dresden Lounge Chair

Width: 29 Depth: 30 Height: 32.75

AH: 25 SH: 20 SD: 20 IW: 20

Weight: 48 / 60 lbs Cube: 23.89

Standard Pillows: N/A Finish Required: Y

Standard Cushions: Ultra Plush Standard Finish: N/A

COL: 85 square feet

1	2	3	4	5	6	8	COL	S Nail	M Nail
3375	3510	3645	3780	3915	4050	5220	2280	Std.	15

LEATHER

L-1601-10

Snyder Bench

Standard Pillows: N/A **Finish Required:** Y
Standard Cushions: High Resiliency 40 **Standard Finish:** N/A
COL: 59.5 square feet

Width: 51 **Depth:** 22 **Height:** 32
AH: 27 **SH:** 19.5 **SD:** 19 **IW:** 46
Weight: 45 / 55 lbs **Cube:** 20.77

1 2895	2 2985	3 3075	4 3165	5 3255	6 3345	8 4170	COL 2196	S Nail N/A	M Nail N/A
------------------	------------------	------------------	------------------	------------------	------------------	------------------	--------------------	----------------------	----------------------

L-1603-10

Luna Bench

Standard Pillows: N/A **Finish Required:** Y
Standard Cushions: High Resiliency 40 **Standard Finish:** N/A
COL: 74 square feet

Width: 56 **Depth:** 22 **Height:** 26.5
AH: 26.5 **SH:** 19.5 **SD:** 22 **IW:** 48
Weight: 55 / 75 lbs **Cube:** 18.89

1 2730	2 2850	3 2970	4 3090	5 3210	6 3330	8 4350	COL 1941	S Nail 60	M Nail 75
------------------	------------------	------------------	------------------	------------------	------------------	------------------	--------------------	---------------------	---------------------

L-1604-20

PELLE PROVISIONS
Kerbey Square Cocktail Ottoman

Standard Pillows: N/A **Finish Required:** N
Standard Cushions: High Resiliency 40 **Standard Finish:** N/A
COL: 74 square feet

Width: 38.5 **Depth:** 38.5 **Height:** 16
AH: - **SH:** 16 **SD:** - **IW:** -
Weight: 37 / 37 lbs **Cube:** 13.72

1 1950	2 2070	3 2190	4 2310	5 2430	6 2550	8 3570	COL 1146	S Nail N/A	M Nail N/A
------------------	------------------	------------------	------------------	------------------	------------------	------------------	--------------------	----------------------	----------------------

L-1605-20

PELLE PROVISIONS
Kilby Round Cocktail Ottoman

Standard Pillows: N/A **Finish Required:** N
Standard Cushions: High Resiliency 40 **Standard Finish:** N/A
COL: 68 square feet

Width: 38.5 **Depth:** 38.5 **Height:** 15.25
AH: - **SH:** 15.25 **SD:** - **IW:** -
Weight: 37 / 37 lbs **Cube:** 13.08

1 1920	2 2025	3 2130	4 2235	5 2340	6 2445	8 3390	COL 1146	S Nail N/A	M Nail N/A
------------------	------------------	------------------	------------------	------------------	------------------	------------------	--------------------	----------------------	----------------------

L-1606-20

PELLE PROVISIONS
Shiloh Round Cocktail Ottoman

Standard Pillows: N/A **Finish Required:** N
Standard Cushions: High Resiliency 40 **Standard Finish:** N/A
COL: 79 square feet

Width: 44.5 **Depth:** 44.5 **Height:** 15.25
AH: - **SH:** 15.25 **SD:** - **IW:** -
Weight: 45 / 45 lbs **Cube:** 17.47

1 2070	2 2190	3 2310	4 2430	5 2550	6 2670	8 3765	COL 1245	S Nail N/A	M Nail N/A
------------------	------------------	------------------	------------------	------------------	------------------	------------------	--------------------	----------------------	----------------------

L-1615-20

Roswell Cocktail Ottoman

Standard Pillows: N/A **Finish Required:** Y
Standard Cushions: High Resiliency 20 **Standard Finish:** N/A
COL: 85 square feet

Width: 33 **Depth:** 33 **Height:** 19.5
AH: - **SH:** - **SD:** - **IW:** -
Weight: 45 / 50 lbs **Cube:** 12.28

1 2400	2 2535	3 2670	4 2805	5 2940	6 3075	8 4245	COL 1680	S Nail 30	M Nail 45
------------------	------------------	------------------	------------------	------------------	------------------	------------------	--------------------	---------------------	---------------------

L-1618-20

Stonewood Oval Cocktail Ottoman

Standard Pillows: N/A **Finish Required:** Y
Standard Cushions: High Resiliency 40 **Standard Finish:** N/A
COL: 34.2 square feet

Width: 38 **Depth:** 25.5 **Height:** 20
AH: - **SH:** - **SD:** - **IW:** -
Weight: 45 / 55 lbs **Cube:** 11.21

1 1980	2 2040	3 2100	4 2160	5 2220	6 2280	8 2760	COL 1548	S Nail N/A	M Nail N/A
------------------	------------------	------------------	------------------	------------------	------------------	------------------	--------------------	----------------------	----------------------

LEATHER

L-1619-20

Cannon Cocktail Ottoman

Standard Pillows: N/A **Finish Required:** Y
Standard Cushions: High Resiliency 40 **Standard Finish:** N/A
COL: 45 square feet

Width: 18.5 **Depth:** 18.5 **Height:** 19.5
AH: - **SH:** - **SD:** - **IW:** -
Weight: 25 / 30 lbs **Cube:** 3.86

1	2	3	4	5	6	8	COL	S Nail	M Nail
1815	1890	1965	2040	2115	2190	2820	1287	30	N/A

L-1672-22

Kaplan Storage Ottoman

Standard Pillows: N/A **Finish Required:** N
Standard Cushions: High Resiliency 30 **Standard Finish:** traditional
COL: 51 square feet
 Features a Lift-off Lid

Width: 19 **Depth:** 19 **Height:** 21
AH: - **SH:** - **SD:** - **IW:** -
Weight: 30 / 35 lbs **Cube:** 4.38

1	2	3	4	5	6	8	COL	S Nail	M Nail
1650	1725	1800	1875	1950	2025	2730	1056	30	45

L-1676-20

Jenkins Cocktail Ottoman

Standard Pillows: N/A **Finish Required:** Y
Standard Cushions: High Resiliency 30 **Standard Finish:** N/A
COL: 63 square feet

Width: 36.5 **Depth:** 36.5 **Height:** 19
AH: - **SH:** - **SD:** - **IW:** -
Weight: 40 / 50 lbs **Cube:** 14.64

1	2	3	4	5	6	8	COL	S Nail	M Nail
2340	2445	2550	2655	2760	2865	3735	1392	60	75

L-1677-20

Joplin Cocktail Ottoman

Standard Pillows: N/A **Finish Required:** Y
Standard Cushions: High Resiliency 35 **Standard Finish:** N/A
COL: 57 square feet

Width: 36.5 **Depth:** 36.5 **Height:** 20
AH: - **SH:** - **SD:** - **IW:** -
Weight: 30 / 35 lbs **Cube:** 15.41

1	2	3	4	5	6	8	COL	S Nail	M Nail
2064	2154	2244	2334	2424	2514	3309	1392	45	60

L-1685-10

Beacon Bench

Standard Pillows: N/A **Finish Required:** Y
Standard Cushions: Endurance **Standard Finish:** N/A
COL: 102 square feet

Width: 55 **Depth:** 23 **Height:** 25
AH: 25 **SH:** 22 **SD:** 18.5 **IW:** 46
Weight: 60 / 80 lbs **Cube:** 18.3

1	2	3	4	5	6	8	COL	S Nail	M Nail
3585	3750	3915	4080	4245	4410	5820	2499	60	75

L-1704-10

Garfield Bench

Standard Pillows: N/A **Finish Required:** Y
Standard Cushions: High Resiliency 40 **Standard Finish:** N/A
COL: 45.9 square feet

Width: 47.5 **Depth:** 19 **Height:** 27.5
AH: 27.5 **SH:** 20 **SD:** 19 **IW:** 36
Weight: 40 / 54 lbs **Cube:** 14.36

1	2	3	4	5	6	8	COL	S Nail	M Nail
2220	2295	2370	2445	2520	2595	3225	1557	45	60

L-1714-E9

Livingston EasyClean Bench

Standard Pillows: N/A **Finish Required:** Y
Standard Cushions: High Resiliency 40 **Standard Finish:** N/A
COL: 72.25 square feet
 Features an EasyClean Seat.

Width: 47 **Depth:** 22 **Height:** 30.5
AH: 27.5 **SH:** 20 **SD:** 18 **IW:** 36
Weight: 55 / 74 lbs **Cube:** 18.25

1	2	3	4	5	6	8	COL	S Nail	M Nail
2805	2925	3045	3165	3285	3405	4410	2025	45	60

LEATHER

L-1742-10

Standard Pillows: N/A **Finish Required:** Y
Standard Cushions: High Resiliency 40 **Standard Finish:** N/A
COL: 72 square feet

Evie Bench

Width: 58 **Depth:** 23.5 **Height:** 26.5
AH: 26.5 **SH:** 19 **SD:** 18 **IW:** 46.5
Weight: 59 / 79 lbs **Cube:** 20.9

1 2865	2 2985	3 3105	4 3225	5 3345	6 3465	8 4455	COL 2046	S Nail 75	M Nail 90
------------------	------------------	------------------	------------------	------------------	------------------	------------------	--------------------	---------------------	---------------------

L-1750-10

Standard Pillows: N/A **Finish Required:** Y
Standard Cushions: High Resiliency 40 **Standard Finish:** N/A
COL: 51 square feet

Inman Bench

Width: 58.5 **Depth:** 19 **Height:** 26
AH: 25.5 **SH:** 19 **SD:** 19 **IW:** 44.5
Weight: 40 / 60 lbs **Cube:** 23.16

1 2235	2 2310	3 2385	4 2460	5 2535	6 2610	8 3315	COL 1662	S Nail 45	M Nail N/A
------------------	------------------	------------------	------------------	------------------	------------------	------------------	--------------------	---------------------	----------------------

L-1751-10

Standard Pillows: N/A **Finish Required:** Y
Standard Cushions: High Resiliency 40 **Standard Finish:** N/A
COL: 63.75 square feet

Jena Bench

Width: 58 **Depth:** 22 **Height:** 27
AH: 27 **SH:** 18.5 **SD:** 17.5 **IW:** 48
Weight: 40 / 50 lbs **Cube:** 19.93

1 2775	2 2880	3 2985	4 3090	5 3195	6 3300	8 4185	COL 1986	S Nail 45	M Nail N/A
------------------	------------------	------------------	------------------	------------------	------------------	------------------	--------------------	---------------------	----------------------

L-1766-10

Standard Pillows: N/A **Finish Required:** Y
Standard Cushions: High Resiliency 40 **Standard Finish:** N/A
COL: 79 square feet

Lacey Bench

Width: 55 **Depth:** 21 **Height:** 26.5
AH: 26 **SH:** 19.5 **SD:** 18 **IW:** 43.5
Weight: 65 / 75 lbs **Cube:** 17.71

1 2640	2 2760	3 2880	4 3000	5 3120	6 3240	8 4335	COL 1821	S Nail 45	M Nail 60
------------------	------------------	------------------	------------------	------------------	------------------	------------------	--------------------	---------------------	---------------------

L-1777-10

Standard Pillows: N/A **Finish Required:** Y
Standard Cushions: High Resiliency 40 **Standard Finish:** N/A
COL: 51 square feet

Lorain Bench

Width: 52.5 **Depth:** 21.5 **Height:** 19.5
AH: - **SH:** - **SD:** - **IW:** -
Weight: 46 / 66 lbs **Cube:** 12.73

1 2235	2 2310	3 2385	4 2460	5 2535	6 2610	8 3315	COL 1557	S Nail 60	M Nail 75
------------------	------------------	------------------	------------------	------------------	------------------	------------------	--------------------	---------------------	---------------------

L-2000-07

Standard Pillows: N/A **Finish Required:** Y
Standard Cushions: High Resiliency 40 **Standard Finish:** N/A
COL: 45 square feet
 Features a Memory Swivel Seat and Sinuous Seating. Standard with two inch channel quilt on outside back.

Robroy Bar Stool

Width: 24.5 **Depth:** 24.5 **Height:** 46.5
AH: 33 **SH:** 30 **SD:** 19 **IW:** 19
Weight: 36 / 49 lbs **Cube:** 16.15

1 2400	2 2475	3 2550	4 2625	5 2700	6 2775	8 3405	COL 1767	S Nail 45	M Nail N/A
------------------	------------------	------------------	------------------	------------------	------------------	------------------	--------------------	---------------------	----------------------

L-2001-C7

PELLE PROVISIONS
Robroy Counter Stool

Standard Pillows: N/A **Finish Required:** Y
Standard Cushions: High Resiliency 40 **Standard Finish:** N/A
COL: 45 square feet
 Features a Memory Swivel Seat and Sinuous Seating

Width: 24.5 **Depth:** 24.5 **Height:** 42.5
AH: 29 **SH:** 26 **SD:** 19 **IW:** 19
Weight: 35 / 46 lbs **Cube:** 14.76

1 2340	2 2415	3 2490	4 2565	5 2640	6 2715	8 3345	COL 1767	S Nail 45	M Nail N/A
------------------	------------------	------------------	------------------	------------------	------------------	------------------	--------------------	---------------------	----------------------

LEATHER

L-2001-07

PELLE PROVISIONS

Robroy Bar Stool

Width: 24.5 Depth: 24.5 Height: 46.5

AH: 33 SH: 30 SD: 19 IW: 19

Weight: 36 / 49 lbs Cube: 19.6

Standard Pillows: N/A Finish Required: Y

Standard Cushions: High Resilency 40 Standard Finish: N/A

COL: 45 square feet

Features a Memory Swivel Seat and Sinuous Seating

1	2	3	4	5	6	8	COL	S Nail	M Nail
2340	2415	2490	2565	2640	2715	3345	1767	45	N/A

L-2002-C7

Vesper Counter Stool

Width: 24 Depth: 26 Height: 40

AH: - SH: 26 SD: 20 IW: 20.5

Weight: 35 / 46 lbs Cube: 15.74

Standard Pillows: N/A Finish Required: Y

Standard Cushions: High Resilency 40 Standard Finish: N/A

COL: 45 square feet

Features a Memory Swivel Seat and Sinuous Seating

1	2	3	4	5	6	8	COL	S Nail	M Nail
2265	2340	2415	2490	2565	2640	3270	1722	45	N/A

L-2002-M7

Vesper Billiard Bar Stool

Width: 24 Depth: 26 Height: 44

AH: - SH: 30 SD: 20 IW: 20.5

Weight: 35 / 46 lbs Cube: 15.88

Standard Pillows: N/A Finish Required: N

Standard Cushions: High Resilency 40 Standard Finish: Nickel

COL: 45 square feet

Gas Lift Standard

1	2	3	4	5	6	8	COL	S Nail	M Nail
2865	2940	3015	3090	3165	3240	3870	1722	45	N/A

L-2002-07

PELLE PROVISIONS

Vesper Bar Stool

Width: 24 Depth: 26 Height: 44

AH: - SH: 30 SD: 20 IW: 20.5

Weight: 35 / 48 lbs Cube: 19.6

Standard Pillows: N/A Finish Required: Y

Standard Cushions: High Resilency 40 Standard Finish: N/A

COL: 45 square feet

Features a Memory Swivel Seat

1	2	3	4	5	6	8	COL	S Nail	M Nail
2265	2340	2415	2490	2565	2640	3270	1722	45	N/A

L-2003-C6

Sidecar Counter Stool

Width: 21.5 Depth: 22.75 Height: 40.25

AH: 32 SH: 26 SD: 19.25 IW: 16.5

Weight: 32 / 43 lbs Cube: 19.6

Standard Pillows: N/A Finish Required: Y

Standard Cushions: High Resilency 40 Standard Finish: N/A

COL: 51 square feet

Features a Memory Swivel Seat

1	2	3	4	5	6	8	COL	S Nail	M Nail
2610	2685	2760	2835	2910	2985	3690	1917	45	N/A

L-2003-06

PELLE PROVISIONS

Sidecar Bar Stool

Width: 21.5 Depth: 22.75 Height: 44.25

AH: 36 SH: 30 SD: 19.25 IW: 16.5

Weight: 33 / 46 lbs Cube: 19.6

Standard Pillows: N/A Finish Required: Y

Standard Cushions: High Resilency 40 Standard Finish: N/A

COL: 51 square feet

Features a Memory Swivel Seat

1	2	3	4	5	6	8	COL	S Nail	M Nail
2610	2685	2760	2835	2910	2985	3690	1917	45	N/A

L-2004-C6

PELLE PROVISIONS

Gimlet Counter Stool

Width: 22.5 Depth: 24.5 Height: 37.25

AH: 32 SH: 26 SD: 19.75 IW: 20.25

Weight: 34 / 44 lbs Cube: 15.74

Standard Pillows: N/A Finish Required: Y

Standard Cushions: High Resilency 40 Standard Finish: N/A

COL: 40 square feet

Features a Memory Swivel Seat

1	2	3	4	5	6	8	COL	S Nail	M Nail
2280	2340	2400	2460	2520	2580	3135	1797	45	N/A

LEATHER

L-2004-06

PELLE PROVISIONS

Gimlet Bar Stool

Width: 22.5 Depth: 24.5 Height: 41.25

AH: 36 SH: 30 SD: 19.75 IW: 20.25

Weight: 34 / 45 lbs Cube: 17.77

Standard Pillows: N/A Finish Required: Y

Standard Cushions: High Resilency 40 Standard Finish: N/A

COL: 40 square feet

Features a Memory Swivel Seat

1	2	3	4	5	6	8	COL	S Nail	M Nail
2280	2340	2400	2460	2520	2580	3135	1797	45	N/A

L-2005-C7

Cosmo Counter Stool

Width: 22 Depth: 22 Height: 32.75

AH: 32.75 SH: 26 SD: 18.75 IW: 17

Weight: 35 / 45 lbs Cube: 15.74

Standard Pillows: N/A Finish Required: Y

Standard Cushions: High Resilency 40 Standard Finish: N/A

COL: 40 square feet

Features a Memory Swivel Seat

1	2	3	4	5	6	8	COL	S Nail	M Nail
2145	2205	2265	2325	2385	2445	3000	1692	45	N/A

L-2005-07

PELLE PROVISIONS

Cosmo Bar Stool

Width: 22 Depth: 22 Height: 36.75

AH: 36.75 SH: 30 SD: 18.75 IW: 17.5

Weight: 35 / 45 lbs Cube: 15.74

Standard Pillows: N/A Finish Required: Y

Standard Cushions: High Resilency 40 Standard Finish: N/A

COL: 40 square feet

Features a Memory Swivel Seat

1	2	3	4	5	6	8	COL	S Nail	M Nail
2145	2205	2265	2325	2385	2445	3000	1692	45	N/A

L-2008-C6

PELLE PROVISIONS

Spritzer Counter Stool

Width: 25.75 Depth: 27.75 Height: 43

AH: 31 SH: 26 SD: 21.5 IW: 22.75

Weight: 39 / 44 lbs Cube: 17.78

Standard Pillows: N/A Finish Required: Y

Standard Cushions: High Resilency 40 Standard Finish: N/A

COL: 51 square feet

Features a Memory Swivel Seat

1	2	3	4	5	6	8	COL	S Nail	M Nail
2400	2475	2550	2625	2700	2775	3480	1917	90	N/A

L-2008-06

PELLE PROVISIONS

Spritzer Bar Stool

Width: 25.75 Depth: 27.75 Height: 47

AH: 35 SH: 30 SD: 21.5 IW: 22.75

Weight: 39 / 54 lbs Cube: 24.14

Standard Pillows: N/A Finish Required: Y

Standard Cushions: High Resilency 40 Standard Finish: N/A

COL: 51 square feet

Features a Memory Swivel Seat

1	2	3	4	5	6	8	COL	S Nail	M Nail
2400	2475	2550	2625	2700	2775	3480	1917	90	N/A

L-2009-C7

Juliet Counter Stool

Width: 21 Depth: 22 Height: 36.5

AH: - SH: 25.5 SD: 19 IW: -

Weight: 25 / 35 lbs Cube: 15.74

Standard Pillows: N/A Finish Required: Y

Standard Cushions: High Resilency 40 Standard Finish: N/A

COL: 29 square feet

1	2	3	4	5	6	8	COL	S Nail	M Nail
1980	2025	2070	2115	2160	2205	2610	1473	N/A	N/A

L-2009-07

Juliet Bar Stool

Width: 21 Depth: 22 Height: 40.5

AH: - SH: 29.5 SD: 19 IW: -

Weight: 25 / 37 lbs Cube: 10.82

Standard Pillows: N/A Finish Required: Y

Standard Cushions: High Resilency 40 Standard Finish: N/A

COL: 29 square feet

1	2	3	4	5	6	8	COL	S Nail	M Nail
1980	2025	2070	2115	2160	2205	2610	1473	N/A	N/A

LEATHER

L-2010-C7

PELLE PROVISIONS
Bellini Counter Stool

Standard Pillows: N/A Finish Required: Y
Standard Cushions: High Resiliency 40 Standard Finish: N/A
COL: 51 square feet
Memory Swivel Standard.

Width: 22.5 Depth: 26 Height: 41
AH: - SH: 26 SD: 19 IW: 185
Weight: 38 / 38 lbs Cube: 13.88

1	2	3	4	5	6	8	COL	S Nail	M Nail
2175	2265	2355	2445	2535	2625	3420	1647	75	N/A

L-2010-07

PELLE PROVISIONS
Bellini Bar Stool

Standard Pillows: N/A Finish Required: Y
Standard Cushions: High Resiliency 40 Standard Finish: N/A
COL: 51 square feet
Memory Swivel Standard.

Width: 22.5 Depth: 26 Height: 45
AH: - SH: 30 SD: 19 IW: 18.5
Weight: 38 / 38 lbs Cube: 15.23

1	2	3	4	5	6	8	COL	S Nail	M Nail
2175	2265	2355	2445	2535	2625	3420	1647	75	N/A

L-2011-C7

PELLE PROVISIONS
Magnolia Counter Stool

Standard Pillows: N/A Finish Required: Y
Standard Cushions: High Resiliency 30 Standard Finish: N/A
COL: 40 square feet

Width: 18.5 Depth: 23.5 Height: 37.75
AH: - SH: 26 SD: 17 IW: 18.5
Weight: 29 / 29 lbs Cube: 9.49

1	2	3	4	5	6	8	COL	S Nail	M Nail
1740	1800	1860	1920	1980	2040	2595	1248	45	N/A

L-2011-05

Magnolia Side Chair

Standard Pillows: N/A Finish Required: Y
Standard Cushions: High Resiliency 30 Standard Finish: N/A
COL: 40 square feet

Width: 21.75 Depth: 21 Height: 34
AH: - SH: 19 SD: 19 IW: 21.75
Weight: 16 / 16 lbs Cube: 8.98

1	2	3	4	5	6	8	COL	S Nail	M Nail
1740	1800	1860	1920	1980	2040	2595	1218	45	N/A

L-2011-07

PELLE PROVISIONS
Magnolia Bar Stool

Standard Pillows: N/A Finish Required: Y
Standard Cushions: High Resiliency 30 Standard Finish: N/A
COL: 40 square feet

Width: 18.5 Depth: 23.5 Height: 41.75
AH: - SH: 30 SD: 17 IW: 18.5
Weight: 30 / 30 lbs Cube: 10.5

1	2	3	4	5	6	8	COL	S Nail	M Nail
1740	1800	1860	1920	1980	2040	2595	1248	45	N/A

L-2012-C6

PELLE PROVISIONS
Allie Counter Stool

Standard Pillows: N/A Finish Required: Y
Standard Cushions: High Resiliency 30 Standard Finish: N/A
COL: 57 square feet

Width: 24.5 Depth: 21.25 Height: 35
AH: 35 SH: 27 SD: 19.5 IW: 18.5
Weight: 42 / 42 lbs Cube: 10.54

1	2	3	4	5	6	8	COL	S Nail	M Nail
2775	2865	2955	3045	3135	3225	4020	2052	N/A	N/A

L-2012-06

PELLE PROVISIONS
Allie Bar Stool

Standard Pillows: N/A Finish Required: Y
Standard Cushions: High Resiliency 30 Standard Finish: N/A
COL: 57 square feet

Width: 24.5 Depth: 21.25 Height: 39
AH: 39 SH: 31 SD: 19.5 IW: 18.5
Weight: 43 / 43 lbs Cube: 11.75

1	2	3	4	5	6	8	COL	S Nail	M Nail
2775	2865	2955	3045	3135	3225	4020	2052	N/A	N/A

LEATHER

L-2014-C7

Riley Counter Stool

Width: 22 Depth: 25.5 Height: 41.25
 AH: - SH: 27.5 SD: 18.5 IW: 20.5
 Weight: 30 / 43 lbs Cube: 13.39

Standard Pillows: N/A Finish Required: Y
 Standard Cushions: High Resiliency 40 Standard Finish: N/A
 COL: 29 square feet
 Features a memory swivel mechanism and a notched opening at the top back edge which provides a convenient holding spot.

1	2	3	4	5	6	8	COL	S Nail	M Nail
2265	2310	2355	2400	2445	2490	2895	1893	N/A	N/A

L-2014-07

Riley Bar Stool

Width: 22 Depth: 25.5 Height: 45.25
 AH: - SH: 31.5 SD: 18.5 IW: 20.5
 Weight: 30 / 55 lbs Cube: 14.69

Standard Pillows: N/A Finish Required: Y
 Standard Cushions: High Resiliency 40 Standard Finish: N/A
 COL: 29 square feet
 Features a memory swivel mechanism and a notched opening at the top back edge which provides a convenient holding spot.

1	2	3	4	5	6	8	COL	S Nail	M Nail
2265	2310	2355	2400	2445	2490	2895	1893	N/A	N/A

L-2015-C7

Riverside Drive Counter Stool

Width: 23.5 Depth: 22.5 Height: 44.5
 AH: 39.5 SH: 27 SD: 17.5 IW: 23.5
 Weight: 23 / 34 lbs Cube: 17.77

Standard Pillows: N/A Finish Required: Y
 Standard Cushions: High Resiliency 35 Standard Finish: N/A
 COL: 51 square feet

1	2	3	4	5	6	8	COL	S Nail	M Nail
2400	2475	2550	2625	2700	2775	3480	1827	Std.	N/A

L-2015-07

Riverside Drive Bar Stool

Width: 23.5 Depth: 22.5 Height: 48.5
 AH: 43.5 SH: 31 SD: 17.5 IW: 23.5
 Weight: 23 / 34 lbs Cube: 17.77

Standard Pillows: N/A Finish Required: Y
 Standard Cushions: High Resiliency 35 Standard Finish: N/A
 COL: 51 square feet

1	2	3	4	5	6	8	COL	S Nail	M Nail
2400	2475	2550	2625	2700	2775	3480	1827	Std.	N/A

L-2016-C7

Doyers Street Counter Stool

Width: 22.25 Depth: 21.75 Height: 34
 AH: - SH: 27 SD: 17 IW: 22.25
 Weight: 22 / 32 lbs Cube: 15.74

Standard Pillows: N/A Finish Required: Y
 Standard Cushions: High Resiliency 40 Standard Finish: N/A
 COL: 40 square feet

1	2	3	4	5	6	8	COL	S Nail	M Nail
2250	2310	2370	2430	2490	2550	3105	1698	Std.	N/A

L-2016-07

Doyers Street Bar Stool

Width: 22.25 Depth: 21.75 Height: 38
 AH: - SH: 31 SD: 17 IW: 22.25
 Weight: 22 / 32 lbs Cube: 15.74

Standard Pillows: N/A Finish Required: Y
 Standard Cushions: High Resiliency 40 Standard Finish: N/A
 COL: 40 square feet

1	2	3	4	5	6	8	COL	S Nail	M Nail
2250	2310	2370	2430	2490	2550	3105	1698	Std.	N/A

L-2017-C6

Finn Counter Stool with Clean Out Seat

Width: 22 Depth: 22 Height: 35
 AH: 30 SH: 26 SD: 18 IW: 18
 Weight: 27 / 27 lbs Cube: 15.74

Standard Pillows: N/A Finish Required: Y
 Standard Cushions: Endurance Standard Finish: N/A
 COL: 57 square feet

1	2	3	4	5	6	8	COL	S Nail	M Nail
2955	3045	3135	3225	3315	3405	4200	2157	N/A	N/A

LEATHER

L-2017-06

Finn Bar Stool

with Clean Out Seat

Width: 22 **Depth:** 22 **Height:** 41
AH: 34 **SH:** 30 **SD:** 18 **IW:** 18
Weight: 27 / 27 lbs **Cube:** 15.74

Standard Pillows: N/A **Finish Required:** Y
Standard Cushions: Endurance **Standard Finish:** N/A
COL: 57 square feet

1 2955	2 3045	3 3135	4 3225	5 3315	6 3405	8 4200	COL 2157	S Nail 60	M Nail N/A
------------------	------------------	------------------	------------------	------------------	------------------	------------------	--------------------	---------------------	----------------------

L-2731-01

Dyson Lounge Chair

Width: 34.5 **Depth:** 27.5 **Height:** 31
AH: 31 **SH:** 18.5 **SD:** 18.5 **IW:** 22
Weight: 53 / 67 lbs **Cube:** 17.02

Standard Pillows: N/A **Finish Required:** Y
Standard Cushions: High Resiliency 40 **Standard Finish:** N/A
COL: 85 square feet

1 3555	2 3690	3 3825	4 3960	5 4095	6 4230	8 5400	COL 2484	S Nail N/A	M Nail N/A
------------------	------------------	------------------	------------------	------------------	------------------	------------------	--------------------	----------------------	----------------------

L-2731-50

Dyson Sofa

Width: 76.5 **Depth:** 27.5 **Height:** 31
AH: 31 **SH:** 18.5 **SD:** 18.5 **IW:** 64
Weight: 101 / 136 lbs **Cube:** 37.74

Standard Pillows: N/A **Finish Required:** Y
Standard Cushions: High Resiliency 40 **Standard Finish:** N/A
COL: 141 square feet

1 4425	2 4635	3 4845	4 5055	5 5265	6 5475	8 7425	COL 3192	S Nail N/A	M Nail N/A
------------------	------------------	------------------	------------------	------------------	------------------	------------------	--------------------	----------------------	----------------------

L-2731-70

Dyson Loveseat

Width: 58 **Depth:** 28 **Height:** 30
AH: 30 **SH:** 18.5 **SD:** 19.5 **IW:** 49
Weight: 75 / 96 lbs **Cube:** 28.19

Standard Pillows: N/A **Finish Required:** Y
Standard Cushions: High Resiliency 40 **Standard Finish:** N/A
COL: 124 square feet

1 4050	2 4245	3 4440	4 4635	5 4830	6 5025	8 6735	COL 2829	S Nail N/A	M Nail N/A
------------------	------------------	------------------	------------------	------------------	------------------	------------------	--------------------	----------------------	----------------------

L-2740-50

Tally Sofa

Leather Sofa with Three Backs over One Seat

Width: 88 **Depth:** 38 **Height:** 37
AH: 24.5 **SH:** 19.5 **SD:** 22.5 **IW:** 80
Weight: 120 / 120 lbs **Cube:** 71.6

Standard Pillows: N/A **Finish Required:** Y
Standard Cushions: Classic Plush **Standard Finish:** N/A
COL: 242 square feet

1 6675	2 7050	3 7425	4 7800	5 8175	6 8550	8 11880	COL 4659	S Nail 135	M Nail N/A
------------------	------------------	------------------	------------------	------------------	------------------	-------------------	--------------------	----------------------	----------------------

L-2743-50

Tally Sofa

Leather Sofa with Three Backs over Three Seats

Width: 88 **Depth:** 38 **Height:** 37
AH: 24.5 **SH:** 19.5 **SD:** 22.5 **IW:** 80
Weight: 120 / 120 lbs **Cube:** 71.6

Standard Pillows: N/A **Finish Required:** Y
Standard Cushions: Classic Plush **Standard Finish:** N/A
COL: 248 square feet

1 6675	2 7050	3 7425	4 7800	5 8175	6 8550	8 11970	COL 4659	S Nail 135	M Nail N/A
------------------	------------------	------------------	------------------	------------------	------------------	-------------------	--------------------	----------------------	----------------------

L-400C-MR

PELLE PROVISIONS

Beth Page Manual Recliner

Manual Push Back Recline

Width: 31 **Depth:** 37.5 **Height:** 43
AH: 24.5 **SH:** 21.5 **SD:** 20 **IW:** 22 **Recl D:** 66 **TV Recl:** 57 **Wall Clr:** 16
Weight: 122 / 130 lbs **Cube:** 43.25

Standard Pillows: N/A **Finish Required:** Y
Standard Cushions: Repose **Standard Finish:** N/A
COL: 147 square feet

1 5325	2 5550	3 5775	4 6000	5 6225	6 6450	8 8475	COL 3792	S Nail 60	M Nail N/A
------------------	------------------	------------------	------------------	------------------	------------------	------------------	--------------------	---------------------	----------------------

LEATHER

L-400C-PR

PELLE PROVISIONS

Beth Page Power Recliner

Power Recline

Width: 31 Depth: 37.5 Height: 39.75

AH: 24.5 SH: 21.5 SD: 20 IW: 22 Recl D: 66 TV Recl: 57 Wall Clr: 16

Weight: 122 / 122 lbs Cube: 43.25

Standard Pillows: N/A Finish Required: Y

Standard Cushions: Repose Standard Finish: N/A

COL: 141 square feet

1	2	3	4	5	6	8	COL	S Nail	M Nail
5775	5985	6195	6405	6615	6825	8775	4242	60	N/A

L-401C-MR

PELLE PROVISIONS

Pinehurst Manual Recliner

Manual Push Back Recline

Width: 31 Depth: 37.5 Height: 39.75

AH: 24.5 SH: 21.5 SD: 20 IW: 22 Recl D: 66 TV Recl: 57 Wall Clr: 16

Weight: 122 / 122 lbs Cube: 26.74

Standard Pillows: N/A Finish Required: Y

Standard Cushions: Repose Standard Finish: N/A

COL: 135 square feet

1	2	3	4	5	6	8	COL	S Nail	M Nail
5325	5535	5745	5955	6165	6375	8235	3792	N/A	N/A

L-401C-PR

PELLE PROVISIONS

Pinehurst Power Recliner

Power Recline

Width: 31 Depth: 37.5 Height: 39.75

AH: 24.5 SH: 21.5 SD: 20 IW: 22 Recl D: 66 TV Recl: 57 Wall Clr: 16

Weight: 122 / 122 lbs Cube: 26.74

Standard Pillows: N/A Finish Required: Y

Standard Cushions: Repose Standard Finish: N/A

COL: 135 square feet

1	2	3	4	5	6	8	COL	S Nail	M Nail
5775	5985	6195	6405	6615	6825	8685	4242	N/A	N/A

L-402C-MR

PELLE PROVISIONS

St. Andrews Manual Recliner

Manual Push Back Recline

Width: 31 Depth: 37.5 Height: 39.75

AH: 24.5 SH: 21.5 SD: 20 IW: 22 Recl D: 66 TV Recl: 57 Wall Clr: 16

Weight: 122 / 122 lbs Cube: 43.25

Standard Pillows: N/A Finish Required: Y

Standard Cushions: Repose Standard Finish: N/A

COL: 152 square feet

1	2	3	4	5	6	8	COL	S Nail	M Nail
5400	5640	5880	6120	6360	6600	8700	3792	60	N/A

L-402C-PR

PELLE PROVISIONS

St. Andrews Power Recliner

Power Recline

Width: 31 Depth: 37.5 Height: 39.75

AH: 24.5 SH: 21.5 SD: 20 IW: 22 Recl D: 66 TV Recl: 57 Wall Clr: 16

Weight: 122 / 122 lbs Cube: 26.74

Standard Pillows: N/A Finish Required: Y

Standard Cushions: Repose Standard Finish: N/A

COL: 152 square feet

1	2	3	4	5	6	8	COL	S Nail	M Nail
5850	6090	6330	6570	6810	7050	9150	4242	60	N/A

L-403C-MR

PELLE PROVISIONS

Spyglass Manual Recliner

Manual Push Back Recline

Width: 31 Depth: 37.5 Height: 39.75

AH: 24.5 SH: 21.5 SD: 20 IW: 22 Recl D: 66 TV Recl: 57 Wall Clr: 16

Weight: 122 / 122 lbs Cube: 26.74

Standard Pillows: N/A Finish Required: Y

Standard Cushions: Repose Standard Finish: N/A

COL: 135 square feet

1	2	3	4	5	6	8	COL	S Nail	M Nail
5400	5610	5820	6030	6240	6450	8310	3792	60	N/A

L-403C-PR

PELLE PROVISIONS

Spyglass Power Recliner

Power Recline

Width: 31 Depth: 37.5 Height: 39.75

AH: 24.5 SH: 21.5 SD: 20 IW: 22 Recl D: 66 TV Recl: 57 Wall Clr: 16

Weight: 122 / 122 lbs Cube: 26.74

Standard Pillows: N/A Finish Required: Y

Standard Cushions: Repose Standard Finish: N/A

COL: 135 square feet

1	2	3	4	5	6	8	COL	S Nail	M Nail
5850	6060	6270	6480	6690	6900	8760	4242	60	N/A

LEATHER

L-408C-MR

PELLE PROVISIONS

Harbour Town Manual Recliner

Manual Push Back Recline

Width: 33 Depth: 37.5 Height: 44

AH: 25.5 SH: 21 SD: 20 IW: 22 Recl D: 66 TV Recl: 57 Wall Clr: 16

Weight: 122 / 122 lbs Cube: 43.25

Standard Pillows: N/A Finish Required: Y

Standard Cushions: Repose Standard Finish: N/A

COL: 141 square feet

1	2	3	4	5	6	8	COL	S Nail	M Nail
5475	5685	5895	6105	6315	6525	8475	3867	45	N/A

L-408C-PR

PELLE PROVISIONS

Harbour Town Power Recliner

Power Recline

Width: 33 Depth: 37.5 Height: 44

AH: 25.5 SH: 21 SD: 20 IW: 22 Recl D: 66 TV Recl: 57 Wall Clr: 16

Weight: 122 / 122 lbs Cube: 43.25

Standard Pillows: N/A Finish Required: Y

Standard Cushions: Repose Standard Finish: N/A

COL: 147 square feet

1	2	3	4	5	6	8	COL	S Nail	M Nail
5925	6150	6375	6600	6825	7050	9075	4317	45	N/A

L-410C-MR

PELLE PROVISIONS

Dale Manual Recliner

Manual Push Back Recline

Width: 33 Depth: 39.5 Height: 41

AH: 24 SH: 21.5 SD: 21 IW: 23 Recl D: 67.5 TV Recl: 56 Wall Clr: 17

Weight: 102 / 121 lbs Cube: 43.25

Standard Pillows: N/A Finish Required: Y

Standard Cushions: Repose Standard Finish: N/A

COL: 169 square feet

1	2	3	4	5	6	8	COL	S Nail	M Nail
5610	5865	6120	6375	6630	6885	9210	3816	120	135

L-410C-PR

RECLINATION

Dale Power Recliner

Leather

Width: 33 Depth: 39.5 Height: 41

AH: 24 SH: 21.5 SD: 21 IW: 23 Recl D: 67.5 TV Recl: 56 Wall Clr: 17

Weight: 102 / 121 lbs Cube: 43.25

Standard Pillows: N/A Finish Required: Y

Standard Cushions: Repose Standard Finish: N/A

COL: 169 square feet

1	2	3	4	5	6	8	COL	S Nail	M Nail
6060	6315	6570	6825	7080	7335	9660	4266	120	135

L-411C-MR

PELLE PROVISIONS

Newberry Manual Recliner

Manual Push Back Recline

Width: 30 Depth: 40 Height: 42

AH: 26.5 SH: 22.5 SD: 20 IW: 21.5 Recl D: 68 TV Recl: 58 Wall Clr: 17.5

Weight: 119 / 138 lbs Cube: 43.25

Standard Pillows: N/A Finish Required: Y

Standard Cushions: Repose Standard Finish: N/A

COL: 147 square feet

1	2	3	4	5	6	8	COL	S Nail	M Nail
5250	5475	5700	5925	6150	6375	8400	3642	105	120

L-411C-PR

RECLINATION, PELLE PROVISIONS

Newberry Power Recliner

Leather

Width: 30 Depth: 40 Height: 42

AH: 26.5 SH: 22.5 SD: 20 IW: 21.5 Recl D: 68 TV Recl: 58 Wall Clr: 17.5

Weight: 119 / 138 lbs Cube: 43.25

Standard Pillows: N/A Finish Required: Y

Standard Cushions: Repose Standard Finish: N/A

COL: 147 square feet

1	2	3	4	5	6	8	COL	S Nail	M Nail
5700	5925	6150	6375	6600	6825	8850	4092	105	120

L-450F-PL

PELLE PROVISIONS

Drake Power Lift Recliner

Power Lift with Power Recline

Width: 29 Depth: 36.5 Height: 40.75

AH: 24.5 SH: 21 SD: 20 IW: 20.5 Recl D: 66 TV Recl: 54.5 Wall Clr: 5

Weight: 129 / 129 lbs Cube: 24.96

Standard Pillows: N/A Finish Required: N

Standard Cushions: Repose Standard Finish: N/A

COL: 164 square feet

Features Dual Motors

1	2	3	4	5	6	8	COL	S Nail	M Nail
7125	7380	7635	7890	8145	8400	10665	5442	45	N/A

LEATHER

L-450G-MR

PELLE PROVISIONS

Drake Manual Swivel Glider Recliner

Manual Push Back Swivel Glider Recline

Width: 29 Depth: 36.5 Height: 40.75

AH: 24.5 SH: 21 SD: 20 IW: 20.5 Recl D: 66 TV Recl: 54.5 Wall Cir: 12

Weight: 129 / 129 lbs Cube: 43.25

Standard Pillows: N/A Finish Required: N

Standard Cushions: Repose Standard Finish: N/A

COL: 147 square feet

1	2	3	4	5	6	8	COL	S Nail	M Nail
5700	5925	6150	6375	6600	6825	8850	4092	45	N/A

L-450G-PR

PELLE PROVISIONS

Drake Power Swivel Glider Recliner

Power Swivel Glider Recline

Width: 29 Depth: 36.5 Height: 40.75

AH: 24.5 SH: 21 SD: 20 IW: 20.5 Recl D: 66 TV Recl: 54.5 Wall Cir: 12

Weight: 129 / 129 lbs Cube: 34.38

Standard Pillows: N/A Finish Required: N

Standard Cushions: Repose Standard Finish: N/A

COL: 147 square feet

1	2	3	4	5	6	8	COL	S Nail	M Nail
6150	6375	6600	6825	7050	7275	9300	4542	45	N/A

L-450K-MR

PELLE PROVISIONS

Drake Manual Glider Recliner

Manual Push Back Recline Glider

Width: 29 Depth: 36.5 Height: 40.75

AH: 24.5 SH: 21 SD: 20 IW: 20.5 Recl D: 66 TV Recl: 54.5 Wall Cir: 12

Weight: 129 / 129 lbs Cube: 24.96

Standard Pillows: N/A Finish Required: N

Standard Cushions: Repose Standard Finish: N/A

COL: 147 square feet

1	2	3	4	5	6	8	COL	S Nail	M Nail
5700	5925	6150	6375	6600	6825	8850	4092	45	N/A

L-450K-PR

PELLE PROVISIONS

Drake Power Glider Recliner

Leather

Width: 29 Depth: 36.5 Height: 40.75

AH: 24.5 SH: 21 SD: 20 IW: 20.5 Recl D: 66 TV Recl: 54.5 Wall Cir: 12

Weight: 129 / 129 lbs Cube: 24.96

Standard Pillows: N/A Finish Required: N

Standard Cushions: Repose Standard Finish: N/A

COL: 147 square feet

1	2	3	4	5	6	8	COL	S Nail	M Nail
6150	6375	6600	6825	7050	7275	9300	4542	45	N/A

L-450Z-MR

PELLE PROVISIONS

Drake Manual Wall Hugger Recliner

Manual Push Back Zero Wall Recline

Width: 29 Depth: 36.5 Height: 40.75

AH: 24.5 SH: 21 SD: 20 IW: 20.5 Recl D: 66 TV Recl: 54.5 Wall Cir: 3.5

Weight: 129 / 129 lbs Cube: 24.96

Standard Pillows: N/A Finish Required: N

Standard Cushions: Repose Standard Finish: N/A

COL: 147 square feet

1	2	3	4	5	6	8	COL	S Nail	M Nail
5475	5700	5925	6150	6375	6600	8625	3867	45	N/A

L-450Z-PR

PELLE PROVISIONS

Drake Power Wall Hugger Recliner

Power Zero Wall Recline

Width: 29 Depth: 36.5 Height: 40.75

AH: 24.5 SH: 21 SD: 20 IW: 20.5 Recl D: 66 TV Recl: 54.5 Wall Cir: 3.5

Weight: 129 / 145 lbs Cube: 34.38

Standard Pillows: N/A Finish Required: N

Standard Cushions: Repose Standard Finish: N/A

COL: 147 square feet

1	2	3	4	5	6	8	COL	S Nail	M Nail
5925	6150	6375	6600	6825	7050	9075	4317	45	N/A

L-4500-10

BD COLLECTION FOR FAIRFIELD

Ofis Bench

Width: 60 Depth: 24 Height: 36

AH: 25.25 SH: 19.5 SD: 19 IW: 57

Weight: 46 / 59 lbs Cube: 20.19

Standard Pillows: N/A Finish Required: Y

Standard Cushions: High Resiliency 40 Standard Finish: N/A

COL: 79 square feet

1	2	3	4	5	6	8	COL	S Nail	M Nail
3825	3945	4065	4185	4305	4425	5520	2970	150	N/A

LEATHER

L-4502-10

BD COLLECTION FOR FAIRFIELD

Lynn Bench

Standard Pillows: N/A Finish Required: Y

Standard Cushions: High Resiliency 40 Standard Finish: N/A

COL: 51 square feet

Width: 60.75 Depth: 21.5 Height: 18.5

AH: - SH: 18.5 SD: 21.5 IW: 60.75

Weight: 50 / 63 lbs Cube: 20.19

1	2	3	4	5	6	8	COL	S Nail	M Nail
2250	2325	2400	2475	2550	2625	3330	1806	N/A	N/A

L-451F-PL

PELLE PROVISIONS

Nolan Power Lift Recliner

Leather

Standard Pillows: N/A Finish Required: N

Standard Cushions: Repose Standard Finish: N/A

COL: 141 square feet

Features Dual Motors

Width: 29 Depth: 36.5 Height: 40.75

AH: 24.5 SH: 21 SD: 20 IW: 20.5 Recl D: 66 TV Recl: 54.5 Wall Clr: 5

Weight: 129 / 129 lbs Cube: 24.96

1	2	3	4	5	6	8	COL	S Nail	M Nail
6450	6660	6870	7080	7290	7500	9450	4992	45	N/A

L-451G-MR

PELLE PROVISIONS

Nolan Manual Swivel Glider Recliner

Manual Push Back Swivel Glider Recline

Standard Pillows: N/A Finish Required: N

Standard Cushions: Repose Standard Finish: N/A

COL: 141 square feet

Width: 29 Depth: 36.5 Height: 40.75

AH: 24.5 SH: 21 SD: 20 IW: 20.5 Recl D: 66 TV Recl: 54.5 Wall Clr: 12

Weight: 129 / 129 lbs Cube: 34.38

1	2	3	4	5	6	8	COL	S Nail	M Nail
5325	5535	5745	5955	6165	6375	8325	3792	45	N/A

L-451G-PR

PELLE PROVISIONS

Nolan Power Swivel Glider Recliner

Power Swivel Glider Recline

Standard Pillows: N/A Finish Required: N

Standard Cushions: Repose Standard Finish: N/A

COL: 141 square feet

Width: 29 Depth: 36.5 Height: 40.75

AH: 24.5 SH: 21 SD: 20 IW: 20.5 Recl D: 66 TV Recl: 54.5 Wall Clr: 12

Weight: 129 / 148 lbs Cube: 43.25

1	2	3	4	5	6	8	COL	S Nail	M Nail
5775	5985	6195	6405	6615	6825	8775	4242	45	N/A

L-451K-MR

PELLE PROVISIONS

Nolan Manual Glider Recliner

Manual Push Back Recline Glider

Standard Pillows: N/A Finish Required: N

Standard Cushions: Repose Standard Finish: N/A

COL: 141 square feet

Width: 29 Depth: 36.5 Height: 40.75

AH: 24.5 SH: 21 SD: 20 IW: 20.5 Recl D: 66 TV Recl: 54.5 Wall Clr: 12

Weight: 129 / 129 lbs Cube: 24.96

1	2	3	4	5	6	8	COL	S Nail	M Nail
5325	5535	5745	5955	6165	6375	8325	3792	45	N/A

L-451K-PR

PELLE PROVISIONS

Nolan Power Glider Recliner

Leather

Standard Pillows: N/A Finish Required: N

Standard Cushions: Repose Standard Finish: N/A

COL: 141 square feet

Width: 29 Depth: 36.5 Height: 40.75

AH: 24.5 SH: 21 SD: 20 IW: 20.5 Recl D: 66 TV Recl: 54.5 Wall Clr: 12

Weight: 129 / 129 lbs Cube: 24.96

1	2	3	4	5	6	8	COL	S Nail	M Nail
5775	5985	6195	6405	6615	6825	8775	4242	45	N/A

L-451Z-MR

PELLE PROVISIONS

Nolan Manual Wall Hugger Recliner

Manual Push Back Zero Wall Recline

Standard Pillows: N/A Finish Required: N

Standard Cushions: Repose Standard Finish: N/A

COL: 141 square feet

Width: 29 Depth: 36.5 Height: 40.75

AH: 24.5 SH: 21 SD: 20 IW: 20.5 Recl D: 66 TV Recl: 54.5 Wall Clr: 3.5

Weight: 129 / 129 lbs Cube: 24.96

1	2	3	4	5	6	8	COL	S Nail	M Nail
5025	5235	5445	5655	5865	6075	8025	3492	45	N/A

LEATHER

L-451Z-PR

PELLE PROVISIONS

Nolan Power Wall Hugger Recliner

Power Zero Wall Recline

Width: 29 Depth: 36.5 Height: 40.75

AH: 24.5 SH: 21 SD: 20 IW: 20.5 Recl D: 66 TV Recl: 54.5 Wall Clr: 3.5

Weight: 129 / 129 lbs Cube: 24.96

Standard Pillows: N/A Finish Required: N

Standard Cushions: Repose Standard Finish: N/A

COL: 141 square feet

1	2	3	4	5	6	8	COL	S Nail	M Nail
5475	5685	5895	6105	6315	6525	8475	3942	45	N/A

L-452F-PL

RECLINATION

Track Arm Power Lift Recliner

Leather

Width: 29 Depth: 36.5 Height: 40.75

AH: 24.5 SH: 18.5 SD: 21 IW: 20.5 Recl D: 66 TV Recl: 54.5 Wall Clr: 5

Weight: 123 / 123 lbs Cube: 24.96

Standard Pillows: N/A Finish Required: N

Standard Cushions: High Resiliency 20 Standard Finish: N/A

COL: 124 square feet

Features Dual Motors

1	2	3	4	5	6	8	COL	S Nail	M Nail
6450	6645	6840	7035	7230	7425	9135	5043	N/A	N/A

L-452G-MR

PELLE PROVISIONS

Track Arm Manual Swivel Glider Recliner

Manual Push Back Swivel Glider Recline

Width: 29 Depth: 36.5 Height: 40.75

AH: 24.5 SH: 20.25 SD: 21 IW: 20.5 Recl D: 66 TV Recl: 54.5 Wall Clr: 12

Weight: 123 / 139 lbs Cube: 43.25

Standard Pillows: N/A Finish Required: N

Standard Cushions: Repose Standard Finish: N/A

COL: 124 square feet

1	2	3	4	5	6	8	COL	S Nail	M Nail
5175	5370	5565	5760	5955	6150	7860	3768	N/A	N/A

L-452G-PR

PELLE PROVISIONS

Track Arm Power Swivel Glider Recliner

Leather

Width: 29 Depth: 36.5 Height: 40.75

AH: 24.5 SH: 20.25 SD: 21 IW: 20.5 Recl D: 66 TV Recl: 54.5 Wall Clr: 12

Weight: 123 / 123 lbs Cube: 24.96

Standard Pillows: N/A Finish Required: N

Standard Cushions: Repose Standard Finish: N/A

COL: 124 square feet

1	2	3	4	5	6	8	COL	S Nail	M Nail
5625	5820	6015	6210	6405	6600	8310	4218	N/A	N/A

L-452K-MR

RECLINATION

Track Arm Manual Glider Recliner

Leather

Width: 29 Depth: 36.5 Height: 40.75

AH: 24.5 SH: 20.25 SD: 21 IW: 20.5 Recl D: 66 TV Recl: 54.5 Wall Clr: 12

Weight: 123 / 123 lbs Cube: 24.96

Standard Pillows: N/A Finish Required: N

Standard Cushions: Repose Standard Finish: N/A

COL: 124 square feet

1	2	3	4	5	6	8	COL	S Nail	M Nail
5100	5295	5490	5685	5880	6075	7785	3768	N/A	N/A

L-452K-PR

RECLINATION

Track Arm Power Glider Recliner

Leather

Width: 29 Depth: 36.5 Height: 40.75

AH: 24.5 SH: 20.25 SD: 21 IW: 20.5 Recl D: 66 TV Recl: 54.5 Wall Clr: 12

Weight: 123 / 123 lbs Cube: 24.96

Standard Pillows: N/A Finish Required: N

Standard Cushions: Repose Standard Finish: N/A

COL: 124 square feet

1	2	3	4	5	6	8	COL	S Nail	M Nail
5550	5745	5940	6135	6330	6525	8235	4218	N/A	N/A

L-452Z-MR

RECLINATION

Track Arm Manual Wall Hugger Recliner

Leather

Width: 29 Depth: 36.5 Height: 40.75

AH: 24.5 SH: 20.25 SD: 21 IW: 20.5 Recl D: 66 TV Recl: 54.5 Wall Clr: 3.5

Weight: 123 / 123 lbs Cube: 24.96

Standard Pillows: N/A Finish Required: N

Standard Cushions: Repose Standard Finish: N/A

COL: 124 square feet

1	2	3	4	5	6	8	COL	S Nail	M Nail
4875	5070	5265	5460	5655	5850	7560	3468	N/A	N/A

LEATHER

L-452Z-PR

RECLINATION

Track Arm Power Wall Hugger Recliner

Leather

Width: 29 Depth: 36.5 Height: 40.75

AH: 24.5 SH: 20.25 SD: 21 IW: 20.5 Recl D: 66 TV Recl: 54.5 Wall Clr: 3.5

Weight: 123 / 123 lbs Cube: 41.32

Standard Pillows: N/A Finish Required: N

Standard Cushions: Repose Standard Finish: N/A

COL: 124 square feet

Features Dual Motors

1	2	3	4	5	6	8	COL	S Nail	M Nail
5325	5520	5715	5910	6105	6300	8010	3918	N/A	N/A

L-453G-MR

PELLE PROVISIONS

Greek Key Arm Manual Swivel Glider Recliner

Manual Push Back Swivel Glider Recline

Width: 32.5 Depth: 36.5 Height: 40.75

AH: 24.25 SH: 20.25 SD: 21 IW: 20.5 Recl D: 66 TV Recl: 54.5 Wall Clr: 12

Weight: 123 / 123 lbs Cube: 27.97

Standard Pillows: N/A Finish Required: N

Standard Cushions: Repose Standard Finish: N/A

COL: 130 square feet

1	2	3	4	5	6	8	COL	S Nail	M Nail
5175	5370	5565	5760	5955	6150	7935	3768	N/A	N/A

L-453G-PR

PELLE PROVISIONS

Greek Key Arm Power Swivel Glider Recliner

Leather

Width: 32.5 Depth: 36.5 Height: 40.75

AH: 25 SH: 20.25 SD: 21 IW: 20.5 Recl D: 66 TV Recl: 54.5 Wall Clr: 12

Weight: 123 / 123 lbs Cube: 27.97

Standard Pillows: N/A Finish Required: N

Standard Cushions: Repose Standard Finish: N/A

COL: 124 square feet

1	2	3	4	5	6	8	COL	S Nail	M Nail
5625	5820	6015	6210	6405	6600	8310	4218	N/A	N/A

L-454F-PL

RECLINATION

Modern Arm Power Lift Recliner

Leather

Width: 31.5 Depth: 36.5 Height: 40.75

AH: 24.75 SH: 18.5 SD: 21 IW: 20.5 Recl D: 66 TV Recl: 54.5 Wall Clr: 5

Weight: 123 / 123 lbs Cube: 27.11

Standard Pillows: N/A Finish Required: N

Standard Cushions: High Resiliency 20 Standard Finish: N/A

COL: 124 square feet

Features Dual Motors

1	2	3	4	5	6	8	COL	S Nail	M Nail
6375	6570	6765	6960	7155	7350	9060	5118	N/A	N/A

L-454G-MR

RECLINATION, PELLE PROVISIONS

Modern Arm Manual Swivel Glider Recliner

Leather

Width: 31.5 Depth: 36.5 Height: 40.75

AH: 24.75 SH: 20.25 SD: 21 IW: 20.5 Recl D: 66 TV Recl: 54.5 Wall Clr: 12

Weight: 123 / 123 lbs Cube: 27.11

Standard Pillows: N/A Finish Required: N

Standard Cushions: Repose Standard Finish: N/A

COL: 124 square feet

1	2	3	4	5	6	8	COL	S Nail	M Nail
5175	5370	5565	5760	5955	6150	7860	3768	N/A	N/A

L-454G-PR

RECLINATION, PELLE PROVISIONS

Modern Arm Power Swivel Glider Recliner

Leather

Width: 31.5 Depth: 36.5 Height: 40.75

AH: 24.75 SH: 20.25 SD: 21 IW: 20.5 Recl D: 66 TV Recl: 54.5 Wall Clr: 12

Weight: 123 / 123 lbs Cube: 27.11

Standard Pillows: N/A Finish Required: N

Standard Cushions: Repose Standard Finish: N/A

COL: 124 square feet

1	2	3	4	5	6	8	COL	S Nail	M Nail
5625	5820	6015	6210	6405	6600	8310	4218	N/A	N/A

L-454Z-MR

RECLINATION

Modern Arm Manual Wall Hugger Recliner

Leather

Width: 31.5 Depth: 36.5 Height: 40.75

AH: 24.75 SH: 20.25 SD: 21 IW: 20.5 Recl D: 66 TV Recl: 54.5 Wall Clr: 3.5

Weight: 123 / 142 lbs Cube: 43.25

Standard Pillows: N/A Finish Required: N

Standard Cushions: Repose Standard Finish: N/A

COL: 124 square feet

1	2	3	4	5	6	8	COL	S Nail	M Nail
4875	5070	5265	5460	5655	5850	7560	3468	N/A	N/A

LEATHER

L-454Z-PR

RECLINATION

Modern Arm Power Wall Hugger Recliner

Leather

Width: 31.5 Depth: 36.5 Height: 40.75

AH: 24.75 SH: 20.25 SD: 21 IW: 20.5 Recl D: 66 TV Recl: 54.5 Wall Clr: 3.5

Weight: 123 / 123 lbs Cube: 27.11

Standard Pillows: N/A Finish Required: N

Standard Cushions: Repose Standard Finish: N/A

COL: 124 square feet

1	2	3	4	5	6	8	COL	S Nail	M Nail
5325	5520	5715	5910	6105	6300	8010	3918	N/A	N/A

L-455G-MR

RECLINATION

Hickory Arm Manual Swivel Glider Recliner

Leather

Width: 31 Depth: 36.5 Height: 40.75

AH: 24.75 SH: 20.25 SD: 21 IW: 20.5 Recl D: 66 TV Recl: 54.5 Wall Clr: 12

Weight: 123 / 123 lbs Cube: 26.68

Standard Pillows: N/A Finish Required: N

Standard Cushions: Repose Standard Finish: N/A

COL: 130 square feet

1	2	3	4	5	6	8	COL	S Nail	M Nail
5175	5370	5565	5760	5955	6150	7935	3768	N/A	N/A

L-455G-PR

RECLINATION

Hickory Arm Power Swivel Glider Recliner

Leather

Width: 31 Depth: 36.5 Height: 40.75

AH: 24.75 SH: 20.25 SD: 21 IW: 20.5 Recl D: 66 TV Recl: 54.5 Wall Clr: 12

Weight: 123 / 123 lbs Cube: 26.68

Standard Pillows: N/A Finish Required: N

Standard Cushions: Repose Standard Finish: N/A

COL: 130 square feet

1	2	3	4	5	6	8	COL	S Nail	M Nail
5625	5820	6015	6210	6405	6600	8385	4218	N/A	N/A

L-456F-PL

RECLINATION

Roll Arm Power Lift Recliner

Leather

Width: 32.5 Depth: 36.5 Height: 40.75

AH: 25 SH: 18.5 SD: 21 IW: 20.5 Recl D: 66 TV Recl: 54.5 Wall Clr: 5

Weight: 123 / 123 lbs Cube: 27.97

Standard Pillows: N/A Finish Required: N

Standard Cushions: High Resiliency 20 Standard Finish: N/A

COL: 130 square feet

Features Dual Motors

1	2	3	4	5	6	8	COL	S Nail	M Nail
6450	6645	6840	7035	7230	7425	9210	5118	45	N/A

L-456G-MR

RECLINATION

Roll Arm Manual Swivel Glider Recliner

Leather

Width: 32.5 Depth: 36.5 Height: 40.75

AH: 25 SH: 20.25 SD: 21 IW: 20.5 Recl D: 66 TV Recl: 0 Wall Clr: 12

Weight: 123 / 123 lbs Cube: 27.97

Standard Pillows: N/A Finish Required: N

Standard Cushions: Repose Standard Finish: N/A

COL: 130 square feet

1	2	3	4	5	6	8	COL	S Nail	M Nail
5175	5370	5565	5760	5955	6150	7935	3768	45	N/A

L-456G-PR

RECLINATION

Roll Arm Power Swivel Glider Recliner

Leather

Width: 32.5 Depth: 36.5 Height: 40.75

AH: 25 SH: 20.25 SD: 21 IW: 20.5 Recl D: 66 TV Recl: 54.5 Wall Clr: 12

Weight: 123 / 123 lbs Cube: 27.97

Standard Pillows: N/A Finish Required: N

Standard Cushions: Repose Standard Finish: N/A

COL: 141 square feet

1	2	3	4	5	6	8	COL	S Nail	M Nail
5625	5835	6045	6255	6465	6675	8625	4218	45	N/A

L-456K-MR

RECLINATION

Roll Arm Manual Glider Recliner

Leather

Width: 32.5 Depth: 36.5 Height: 40.75

AH: 25 SH: 20.25 SD: 21 IW: 20.5 Recl D: 66 TV Recl: 54.5 Wall Clr: 12

Weight: 123 / 123 lbs Cube: 27.97

Standard Pillows: N/A Finish Required: N

Standard Cushions: Repose Standard Finish: N/A

COL: 141 square feet

1	2	3	4	5	6	8	COL	S Nail	M Nail
5175	5385	5595	5805	6015	6225	8175	3768	45	N/A

LEATHER

L-456K-PR

RECLINATION

Roll Arm Power Glider Recliner

Leather

Width: 32.5 Depth: 36.5 Height: 40.75

AH: 25 SH: 20.25 SD: 21 IW: 20.5 Recl D: 66 TV Recl: 54.5 Wall Clr: 12

Weight: 123 / 123 lbs Cube: 27.97

Standard Pillows: N/A Finish Required: N

Standard Cushions: Repose Standard Finish: N/A

COL: 141 square feet

1	2	3	4	5	6	8	COL	S Nail	M Nail
5625	5835	6045	6255	6465	6675	8625	4218	45	N/A

L-456Z-MR

RECLINATION

Roll Arm Manual Wall Hugger Recliner

Leather

Width: 32.5 Depth: 36.5 Height: 40.75

AH: 25 SH: 20.25 SD: 21 IW: 20.5 Recl D: 66 TV Recl: 54.5 Wall Clr: 3.5

Weight: 123 / 123 lbs Cube: 27.97

Standard Pillows: N/A Finish Required: N

Standard Cushions: Repose Standard Finish: N/A

COL: 141 square feet

1	2	3	4	5	6	8	COL	S Nail	M Nail
5100	5310	5520	5730	5940	6150	8100	3468	45	N/A

L-456Z-PR

RECLINATION

Roll Arm Power Wall Hugger Recliner

Leather

Width: 32.5 Depth: 36.5 Height: 40.75

AH: 25 SH: 20.25 SD: 21 IW: 20.5 Recl D: 66 TV Recl: 54.5 Wall Clr: 3.5

Weight: 123 / 123 lbs Cube: 27.97

Standard Pillows: N/A Finish Required: N

Standard Cushions: Repose Standard Finish: N/A

COL: 141 square feet

1	2	3	4	5	6	8	COL	S Nail	M Nail
5550	5760	5970	6180	6390	6600	8550	3918	45	N/A

L-4599-C6

BD COLLECTION FOR FAIRFIELD, PELLE PROVISIONS

Warner Counter Stool

Width: 21 Depth: 23 Height: 42.5

AH: 32 SH: 27 SD: 19 IW: 14

Weight: 24 / 24 lbs Cube: 11.87

Standard Pillows: N/A Finish Required: N

Standard Cushions: High Resiliency 40 Standard Finish: White

COL: 34 square feet

1	2	3	4	5	6	8	COL	S Nail	M Nail
1725	1785	1845	1905	1965	2025	2490	1398	N/A	N/A

L-4599-04

BD COLLECTION FOR FAIRFIELD, PELLE PROVISIONS

Warner Dining Chair

Width: 22.5 Depth: 23.5 Height: 36.5

AH: 25.5 SH: 19 SD: 19.5 IW: 20.5

Weight: 31 / 31 lbs Cube: 11.16

Standard Pillows: N/A Finish Required: N

Standard Cushions: High Resiliency 40 Standard Finish: White

COL: 34 square feet

1	2	3	4	5	6	8	COL	S Nail	M Nail
1485	1545	1605	1665	1725	1785	2250	1173	N/A	N/A

L-4599-06

BD COLLECTION FOR FAIRFIELD, PELLE PROVISIONS

Warner Bar Stool

Width: 21 Depth: 23 Height: 46.5

AH: 36 SH: 31 SD: 19 IW: 14

Weight: 24 / 24 lbs Cube: 12.99

Standard Pillows: N/A Finish Required: N

Standard Cushions: High Resiliency 40 Standard Finish: White

COL: 34 square feet

1	2	3	4	5	6	8	COL	S Nail	M Nail
1725	1785	1845	1905	1965	2025	2490	1398	N/A	N/A

L-4600-C6

BD COLLECTION FOR FAIRFIELD, PELLE PROVISIONS

Warner Counter Stool

Width: 21 Depth: 23 Height: 42.5

AH: 32 SH: 27 SD: 19 IW: 14

Weight: 24 / 24 lbs Cube: 11.87

Standard Pillows: N/A Finish Required: N

Standard Cushions: High Resiliency 40 Standard Finish: N/A

COL: 34 square feet

1	2	3	4	5	6	8	COL	S Nail	M Nail
1725	1785	1845	1905	1965	2025	2490	1398	N/A	N/A

LEATHER

L-4600-04

BD COLLECTION FOR FAIRFIELD, PELLE PROVISIONS

Warner Dining Chair

Standard Pillows: N/A Finish Required: N

Standard Cushions: High Resiliency 40 Standard Finish: N/A

COL: 34 square feet

Width: 22.5 Depth: 23.5 Height: 36.5

AH: 25.5 SH: 19 SD: 19.5 IW: 20.5

Weight: 31 / 31 lbs Cube: 11.16

1	2	3	4	5	6	8	COL	S Nail	M Nail
1485	1545	1605	1665	1725	1785	2250	1173	N/A	N/A

L-4600-06

BD COLLECTION FOR FAIRFIELD, PELLE PROVISIONS

Warner Bar Stool

Standard Pillows: N/A Finish Required: N

Standard Cushions: High Resiliency 40 Standard Finish: N/A

COL: 34 square feet

Width: 21 Depth: 23 Height: 46.5

AH: 36 SH: 31 SD: 19 IW: 14

Weight: 24 / 24 lbs Cube: 12.99

1	2	3	4	5	6	8	COL	S Nail	M Nail
1725	1785	1845	1905	1965	2025	2490	1398	N/A	N/A

L-4601-A2

BD COLLECTION FOR FAIRFIELD

Brady Leather Dining Chair

with Two Casters

Standard Pillows: N/A Finish Required: Y

Standard Cushions: High Resiliency 40 Standard Finish: N/A

COL: 29 square feet

Width: 24 Depth: 24.5 Height: 42.5

AH: 25 SH: 19 SD: 19.5 IW: 20

Weight: 20 / 20 lbs Cube: 14.46

1	2	3	4	5	6	8	COL	S Nail	M Nail
1530	1575	1620	1665	1710	1755	2160	1203	45	60

L-4601-C6

BD COLLECTION FOR FAIRFIELD

Brady Leather Counter Stool

Standard Pillows: N/A Finish Required: Y

Standard Cushions: High Resiliency 40 Standard Finish: N/A

COL: 29 square feet

Width: 23.5 Depth: 23.5 Height: 43

AH: 32.5 SH: 26 SD: 20 IW: 19

Weight: 20 / 20 lbs Cube: 13.74

1	2	3	4	5	6	8	COL	S Nail	M Nail
1575	1620	1665	1710	1755	1800	2205	1323	45	60

L-4601-04

BD COLLECTION FOR FAIRFIELD

Brady Leather Dining Chair

Standard Pillows: N/A Finish Required: Y

Standard Cushions: High Resiliency 40 Standard Finish: N/A

COL: 29 square feet

Width: 24 Depth: 24.5 Height: 42.5

AH: 25 SH: 19 SD: 19.5 IW: 20

Weight: 20 / 20 lbs Cube: 14.46

1	2	3	4	5	6	8	COL	S Nail	M Nail
1500	1545	1590	1635	1680	1725	2130	1203	45	60

L-4604-A2

BD COLLECTION FOR FAIRFIELD

Xander Leather Dining Chair

with Two Casters

Standard Pillows: N/A Finish Required: Y

Standard Cushions: High Resiliency 40 Standard Finish: N/A

COL: 40 square feet

Width: 23.5 Depth: 24 Height: 39.5

AH: 25 SH: 19 SD: 18.5 IW: 18.5

Weight: 20 / 20 lbs Cube: 12.89

1	2	3	4	5	6	8	COL	S Nail	M Nail
1770	1830	1890	1950	2010	2070	2625	1293	N/A	N/A

L-4604-C6

BD COLLECTION FOR FAIRFIELD

Xander Leather Counter Stool

Standard Pillows: N/A Finish Required: Y

Standard Cushions: High Resiliency 40 Standard Finish: N/A

COL: 40 square feet

Width: 23.5 Depth: 24 Height: 42

AH: 30 SH: 25.5 SD: 18.5 IW: 18.5

Weight: 23 / 23 lbs Cube: 13.7

1	2	3	4	5	6	8	COL	S Nail	M Nail
1875	1935	1995	2055	2115	2175	2730	1398	N/A	N/A

LEATHER

L-4604-04

BD COLLECTION FOR FAIRFIELD
Xander Leather Dining Chair

Standard Pillows: N/A **Finish Required:** Y
Standard Cushions: High Resiliency 40 **Standard Finish:** N/A
COL: 40 square feet

Width: 23.5 **Depth:** 24 **Height:** 39.5
AH: 25 **SH:** 19 **SD:** 18.5 **IW:** 18.5
Weight: 20 / 20 lbs **Cube:** 12.89

1	2	3	4	5	6	8	COL	S Nail	M Nail
1725	1785	1845	1905	1965	2025	2580	1293	N/A	N/A

L-4605-A2

BD COLLECTION FOR FAIRFIELD
Anderson Arm Chair

Standard Pillows: N/A **Finish Required:** Y
Standard Cushions: High Resiliency 40 **Standard Finish:** N/A
COL: 68 square feet

Width: 24.5 **Depth:** 28.5 **Height:** 39.5
AH: 25.25 **SH:** 19.5 **SD:** 19.5 **IW:** 19.5
Weight: 25 / 38 lbs **Cube:** 21.65

1	2	3	4	5	6	8	COL	S Nail	M Nail
2775	2880	2985	3090	3195	3300	4245	1830	N/A	N/A

L-4605-A2-P

BD COLLECTION FOR FAIRFIELD
Anderson Arm Chair with Pull

Standard Pillows: N/A **Finish Required:** Y
Standard Cushions: High Resiliency 40 **Standard Finish:** N/A
COL: 68 square feet
 Features a decorative leather handle with cream accent stitching.

Width: 24.5 **Depth:** 28.5 **Height:** 39.5
AH: 25.25 **SH:** 19.5 **SD:** 19.5 **IW:** 19.5
Weight: 25 / 35 lbs **Cube:** 15.96

1	2	3	4	5	6	8	COL	S Nail	M Nail
2805	2910	3015	3120	3225	3330	4275	1830	N/A	N/A

L-4605-A4

BD COLLECTION FOR FAIRFIELD
Anderson Arm Chair

Standard Pillows: N/A **Finish Required:** Y
Standard Cushions: High Resiliency 40 **Standard Finish:** N/A
COL: 68 square feet

Width: 24.5 **Depth:** 28.5 **Height:** 39.5
AH: 25.25 **SH:** 19.5 **SD:** 19.5 **IW:** 19.5
Weight: 25 / 38 lbs **Cube:** 21.65

1	2	3	4	5	6	8	COL	S Nail	M Nail
2820	2925	3030	3135	3240	3345	4290	1830	N/A	N/A

L-4605-A4-P

BD COLLECTION FOR FAIRFIELD
Anderson Arm Chair with Pull

Standard Pillows: N/A **Finish Required:** Y
Standard Cushions: High Resiliency 40 **Standard Finish:** N/A
COL: 68 square feet
 Features a decorative leather handle with cream accent stitching.

Width: 24.5 **Depth:** 28.5 **Height:** 39.5
AH: 25.25 **SH:** 19.5 **SD:** 19.5 **IW:** 19.5
Weight: 25 / 35 lbs **Cube:** 15.96

1	2	3	4	5	6	8	COL	S Nail	M Nail
2850	2955	3060	3165	3270	3375	4320	1830	N/A	N/A

L-4605-C6

BD COLLECTION FOR FAIRFIELD
Anderson Arm Counter Stool

Standard Pillows: N/A **Finish Required:** Y
Standard Cushions: High Resiliency 40 **Standard Finish:** N/A
COL: 57 square feet

Width: 24.5 **Depth:** 26 **Height:** 40
AH: 32 **SH:** 27 **SD:** 19.5 **IW:** 19.5
Weight: 29 / 39 lbs **Cube:** 15.74

1	2	3	4	5	6	8	COL	S Nail	M Nail
2745	2835	2925	3015	3105	3195	3990	1860	N/A	N/A

L-4605-C6-P

BD COLLECTION FOR FAIRFIELD
Anderson Arm Counter Stool

Standard Pillows: N/A **Finish Required:** Y
Standard Cushions: High Resiliency 40 **Standard Finish:** N/A
COL: 57 square feet
 Features a decorative leather handle with cream accent stitching.

Width: 24.5 **Depth:** 26 **Height:** 40
AH: 32 **SH:** 27 **SD:** 19.5 **IW:** 19.5
Weight: 29 / 39 lbs **Cube:** 15.74

1	2	3	4	5	6	8	COL	S Nail	M Nail
2775	2865	2955	3045	3135	3225	4020	1860	N/A	N/A

LEATHER

L-4605-04

BD COLLECTION FOR FAIRFIELD
Anderson Arm Chair

Standard Pillows: N/A Finish Required: Y
Standard Cushions: High Resilency 40 Standard Finish: N/A
COL: 68 square feet

Width: 24.5 Depth: 28.5 Height: 39.5
AH: 25.25 SH: 19.5 SD: 19.5 IW: 19.5
Weight: 25 / 38 lbs Cube: 21.65

1	2	3	4	5	6	8	COL	S Nail	M Nail
2745	2850	2955	3060	3165	3270	4215	1830	N/A	N/A

L-4605-04-P

BD COLLECTION FOR FAIRFIELD
Anderson Arm Chair with Pull

Standard Pillows: N/A Finish Required: Y
Standard Cushions: High Resilency 40 Standard Finish: N/A
COL: 68 square feet
Features a decorative leather handle with cream accent stitching.

Width: 24.5 Depth: 28.5 Height: 39.5
AH: 25.25 SH: 19.5 SD: 19.5 IW: 19.5
Weight: 25 / 38 lbs Cube: 21.65

1	2	3	4	5	6	8	COL	S Nail	M Nail
2775	2880	2985	3090	3195	3300	4245	1830	N/A	N/A

L-4605-06

BD COLLECTION FOR FAIRFIELD
Anderson Arm Bar Stool

Standard Pillows: N/A Finish Required: Y
Standard Cushions: High Resilency 40 Standard Finish: N/A
COL: 57 square feet

Width: 24.5 Depth: 26 Height: 44
AH: 36 SH: 31 SD: 19.5 IW: 19.5
Weight: 30 / 43 lbs Cube: 19.6

1	2	3	4	5	6	8	COL	S Nail	M Nail
2745	2835	2925	3015	3105	3195	3990	1860	N/A	N/A

L-4605-06-P

BD COLLECTION FOR FAIRFIELD
Anderson Arm Bar Stool with Pull

Standard Pillows: N/A Finish Required: Y
Standard Cushions: High Resilency 40 Standard Finish: N/A
COL: 57 square feet
Features a decorative leather handle with cream accent stitching.

Width: 24.5 Depth: 26 Height: 44
AH: 36 SH: 31 SD: 19.5 IW: 19.5
Weight: 30 / 43 lbs Cube: 19.6

1	2	3	4	5	6	8	COL	S Nail	M Nail
2775	2865	2955	3045	3135	3225	4020	1860	N/A	N/A

L-4606-A2

BD COLLECTION FOR FAIRFIELD
Gigi Arm Chair

Standard Pillows: N/A Finish Required: Y
Standard Cushions: High Resilency 40 Standard Finish: N/A
COL: 57 square feet

Width: 27.5 Depth: 25 Height: 33.5
AH: 25.5 SH: 18.5 SD: 18.5 IW: 20.25
Weight: 27 / 37 lbs Cube: 13.32

1	2	3	4	5	6	8	COL	S Nail	M Nail
3090	3195	3300	3405	3510	3615	4470	2256	N/A	N/A

L-4606-A4

BD COLLECTION FOR FAIRFIELD
Gigi Arm Chair

Standard Pillows: N/A Finish Required: Y
Standard Cushions: High Resilency 40 Standard Finish: N/A
COL: 57 square feet

Width: 27.5 Depth: 25 Height: 33.5
AH: 25.5 SH: 18.5 SD: 18.5 IW: 20.25
Weight: 27 / 40 lbs Cube: 21.65

1	2	3	4	5	6	8	COL	S Nail	M Nail
3135	3240	3345	3450	3555	3660	4515	2256	N/A	N/A

L-4606-C6

BD COLLECTION FOR FAIRFIELD
Gigi Arm Counter Stool

Standard Pillows: N/A Finish Required: Y
Standard Cushions: High Resilency 40 Standard Finish: N/A
COL: 62 square feet

Width: 27.5 Depth: 25 Height: 40
AH: 32 SH: 25 SD: 18.5 IW: 20.25
Weight: 30 / 43 lbs Cube: 21.65

1	2	3	4	5	6	8	COL	S Nail	M Nail
3060	3165	3270	3375	3480	3585	4440	2256	N/A	N/A

LEATHER

L-4606-04

BD COLLECTION FOR FAIRFIELD
Gigi Arm Chair

Standard Pillows: N/A Finish Required: Y
Standard Cushions: High Resiliency 40 Standard Finish: N/A
COL: 57 square feet

Width: 27.5 Depth: 25 Height: 33.5
AH: 25.5 SH: 18.5 SD: 18.5 IW: 20.25
Weight: 27 / 40 lbs Cube: 21.65

1	2	3	4	5	6	8	COL	S Nail	M Nail
3060	3165	3270	3375	3480	3585	4440	2256	N/A	N/A

L-4606-06

BD COLLECTION FOR FAIRFIELD
Gigi Arm Bar Stool

Standard Pillows: N/A Finish Required: Y
Standard Cushions: High Resiliency 40 Standard Finish: N/A
COL: 62 square feet

Width: 27.5 Depth: 25 Height: 44
AH: 36 SH: 29 SD: 18.5 IW: 20.25
Weight: 31 / 44 lbs Cube: 24.14

1	2	3	4	5	6	8	COL	S Nail	M Nail
3060	3165	3270	3375	3480	3585	4440	2256	N/A	N/A

L-4608-A2

BD COLLECTION FOR FAIRFIELD
Gerheart Leather Dining Chair
with Two Casters

Standard Pillows: N/A Finish Required: Y
Standard Cushions: High Resiliency 40 Standard Finish: N/A
COL: 45 square feet

Width: 24 Depth: 24.5 Height: 38
AH: 25.5 SH: 20 SD: 20 IW: 18
Weight: 23 / 23 lbs Cube: 12.93

1	2	3	4	5	6	8	COL	S Nail	M Nail
1785	1860	1935	2010	2085	2160	2790	1248	45	N/A

L-4608-A4

BD COLLECTION FOR FAIRFIELD, PELLE PROVISIONS
Gerheart Leather Dining Chair
with Four Casters

Standard Pillows: N/A Finish Required: Y
Standard Cushions: High Resiliency 40 Standard Finish: N/A
COL: 45 square feet

Width: 24 Depth: 24.5 Height: 38
AH: 25.5 SH: 20 SD: 20 IW: 18
Weight: 23 / 23 lbs Cube: 12.93

1	2	3	4	5	6	8	COL	S Nail	M Nail
1830	1905	1980	2055	2130	2205	2835	1248	45	N/A

L-4608-C6

BD COLLECTION FOR FAIRFIELD, PELLE PROVISIONS
Gerheart Leather Counter Stool

Standard Pillows: N/A Finish Required: Y
Standard Cushions: High Resiliency 40 Standard Finish: N/A
COL: 45 square feet

Width: 21 Depth: 23.5 Height: 42.5
AH: 32 SH: 27 SD: 19 IW: 14
Weight: 24 / 24 lbs Cube: 12.13

1	2	3	4	5	6	8	COL	S Nail	M Nail
1800	1875	1950	2025	2100	2175	2805	1323	45	N/A

L-4608-04

BD COLLECTION FOR FAIRFIELD, PELLE PROVISIONS
Gerheart Leather Dining Chair

Standard Pillows: N/A Finish Required: Y
Standard Cushions: High Resiliency 40 Standard Finish: N/A
COL: 45 square feet

Width: 24 Depth: 24.5 Height: 38
AH: 25.5 SH: 20 SD: 20 IW: 18
Weight: 23 / 23 lbs Cube: 12.93

1	2	3	4	5	6	8	COL	S Nail	M Nail
1755	1830	1905	1980	2055	2130	2760	1248	45	N/A

L-462C-MR

PELLE PROVISIONS
Loft Manual Recliner
Leather

Standard Pillows: N/A Finish Required: Y
Standard Cushions: Repose Standard Finish: N/A
COL: 119 square feet

Width: 29.5 Depth: 35 Height: 41.5
AH: 24 SH: 21.25 SD: 21 IW: 21.25 Recl D: 65 TV Recl: 56 Wall Clr: 12
Weight: 95 / 95 lbs Cube: 43.25

1	2	3	4	5	6	8	COL	S Nail	M Nail
4725	4905	5085	5265	5445	5625	7260	3468	N/A	N/A

LEATHER

L-462C-PR

PELLE PROVISIONS

Loft Power Recliner

Leather

Width: 29.5 Depth: 35 Height: 41.5

AH: 24 SH: 21.25 SD: 21 IW: 21.25 Recl D: 65 TV Recl: 56 Wall Clr: 12

Weight: 95 / 95 lbs Cube: 24.79

Standard Pillows: N/A Finish Required: Y

Standard Cushions: Repose Standard Finish: N/A

COL: 119 square feet

1	2	3	4	5	6	8	COL	S Nail	M Nail
5175	5355	5535	5715	5895	6075	7710	3918	N/A	N/A

L-462P-MR-1

PELLE PROVISIONS

Loft Manual Recliner with Swivel Five Prong Base

Manual Push Back Swivel Recline with Five Prong Base

Width: 29.5 Depth: 35 Height: 41.5

AH: 24 SH: 21.25 SD: 21 IW: 21.25 Recl D: 65 TV Recl: 56 Wall Clr: 12

Weight: 95 / 95 lbs Cube: 34.38

Standard Pillows: N/A Finish Required: Y

Standard Cushions: Repose Standard Finish: N/A

COL: 119 square feet

Metal Prong Base in Bronze

1	2	3	4	5	6	8	COL	S Nail	M Nail
5100	5280	5460	5640	5820	6000	7635	3819	N/A	N/A

L-462P-MR-2

PELLE PROVISIONS

Loft Manual Recliner with Swivel Five Prong Base

Manual Push Back Swivel Recline with Five Prong Base

Width: 29.5 Depth: 35 Height: 41.5

AH: 24 SH: 21.25 SD: 21 IW: 21.25 Recl D: 65 TV Recl: 56 Wall Clr: 12

Weight: 95 / 95 lbs Cube: 43.25

Standard Pillows: N/A Finish Required: Y

Standard Cushions: Repose Standard Finish: N/A

COL: 119 square feet

Metal Prong Base in Brushed Nickel

1	2	3	4	5	6	8	COL	S Nail	M Nail
5100	5280	5460	5640	5820	6000	7635	3819	N/A	N/A

L-462P-MR-7

PELLE PROVISIONS

Loft Manual Recliner with Swivel Five Prong Base

Manual Push Back Swivel Recline with Five Prong Base

Width: 29.5 Depth: 35 Height: 41.5

AH: 24 SH: 21.25 SD: 21 IW: 21.25 Recl D: 65 TV Recl: 56 Wall Clr: 12

Weight: 95 / 95 lbs Cube: 24.79

Standard Pillows: N/A Finish Required: Y

Standard Cushions: Repose Standard Finish: N/A

COL: 119 square feet

Metal Prong Base in Bright Brass

1	2	3	4	5	6	8	COL	S Nail	M Nail
5100	5280	5460	5640	5820	6000	7635	3819	N/A	N/A

L-462P-PR-1

PELLE PROVISIONS

Loft Power Recliner with Swivel with Five Prong Base

Power Swivel Recline with Five Prong Base

Width: 29.5 Depth: 35 Height: 41.5

AH: 24 SH: 21.25 SD: 21 IW: 21.25 Recl D: 65 TV Recl: 56 Wall Clr: 12

Weight: 95 / 95 lbs Cube: 34.38

Standard Pillows: N/A Finish Required: Y

Standard Cushions: Repose Standard Finish: N/A

COL: 119 square feet

Metal Prong Base in Bronze

1	2	3	4	5	6	8	COL	S Nail	M Nail
5550	5730	5910	6090	6270	6450	8085	4269	N/A	N/A

L-462P-PR-2

PELLE PROVISIONS

Loft Power Recliner with Swivel Five Prong Base

Power Swivel Recline with Five Prong Base

Width: 29.5 Depth: 35 Height: 41.5

AH: 24 SH: 21.25 SD: 21 IW: 21.25 Recl D: 65 TV Recl: 56 Wall Clr: 12

Weight: 95 / 95 lbs Cube: 34.38

Standard Pillows: N/A Finish Required: Y

Standard Cushions: Repose Standard Finish: N/A

COL: 119 square feet

Metal Prong Base in Brushed Nickel

1	2	3	4	5	6	8	COL	S Nail	M Nail
5550	5730	5910	6090	6270	6450	8085	4269	N/A	N/A

L-462P-PR-7

PELLE PROVISIONS

Loft Power Recliner with Swivel with Five Prong Base

Power Swivel Recline with Five Prong Base

Width: 29.5 Depth: 35 Height: 41.5

AH: 24 SH: 21.25 SD: 21 IW: 21.25 Recl D: 65 TV Recl: 56 Wall Clr: 12

Weight: 95 / 95 lbs Cube: 34.38

Standard Pillows: N/A Finish Required: Y

Standard Cushions: Repose Standard Finish: N/A

COL: 119 square feet

Metal Prong Base in Bright Brass

1	2	3	4	5	6	8	COL	S Nail	M Nail
5550	5730	5910	6090	6270	6450	8085	4269	N/A	N/A

LEATHER

L-464C-MR

PELLE PROVISIONS

Aspire Manual Recliner

Manual Push Back Recline

Width: 29.5 Depth: 33.25 Height: 42

AH: 22.5 SH: 21.5 SD: 19.5 IW: 22 Recl D: 62.5 TV Recl: 54 Wall Clr: 12

Weight: 95 / 95 lbs Cube: 43.25

Standard Pillows: N/A Finish Required: Y

Standard Cushions: Repose Standard Finish: N/A

COL: 124 square feet

1	2	3	4	5	6	8	COL	S Nail	M Nail
4875	5070	5265	5460	5655	5850	7560	3792	N/A	N/A

L-464P-MR-1

PELLE PROVISIONS

Aspire Manual Recliner with Swivel Five Prong Base

Manual Push Back Swivel Recline with Five Prong Base

Width: 29.5 Depth: 33.25 Height: 42

AH: 22.5 SH: 21.5 SD: 19.5 IW: 22 Recl D: 62.5 TV Recl: 54 Wall Clr: 12

Weight: 95 / 95 lbs Cube: 23.84

Standard Pillows: N/A Finish Required: N

Standard Cushions: Repose Standard Finish: Bronze

COL: 124 square feet

Metal Prong Base in Bronze

1	2	3	4	5	6	8	COL	S Nail	M Nail
5025	5220	5415	5610	5805	6000	7710	3867	N/A	N/A

L-464P-MR-2

PELLE PROVISIONS

Aspire Manual Recliner with Swivel Five Prong Base

Manual Push Back Swivel Recline with Five Prong Base

Width: 29.5 Depth: 33.25 Height: 42

AH: 22.5 SH: 21.5 SD: 19.5 IW: 22 Recl D: 62.5 TV Recl: 56 Wall Clr: 12

Weight: 95 / 95 lbs Cube: 34.38

Standard Pillows: N/A Finish Required: N

Standard Cushions: Repose Standard Finish: BRUSHED NICKEL

COL: 124 square feet

Metal Prong Base in Brushed Nickel

1	2	3	4	5	6	8	COL	S Nail	M Nail
5025	5220	5415	5610	5805	6000	7710	3867	N/A	N/A

L-464P-PR-1

PELLE PROVISIONS

Aspire Power Recliner with Swivel with Five Prong Base

Power Swivel Recline with Five Prong Base

Width: 29.5 Depth: 33.25 Height: 42

AH: 22.5 SH: 21.5 SD: 19.5 IW: 22 Recl D: 62.5 TV Recl: 54 Wall Clr: 12

Weight: 95 / 95 lbs Cube: 23.84

Standard Pillows: N/A Finish Required: N

Standard Cushions: Repose Standard Finish: Bronze

COL: 124 square feet

Features a motion control switch on the outside of the left side facing arm and a Metal Prong Base in Bronze.

1	2	3	4	5	6	8	COL	S Nail	M Nail
5475	5670	5865	6060	6255	6450	8160	4317	N/A	N/A

L-464P-PR-2

PELLE PROVISIONS

Aspire Power Recliner with Swivel Five Prong Base

Power Swivel Recline with Five Prong Base

Width: 29.5 Depth: 33.25 Height: 42

AH: 22.5 SH: 21.5 SD: 19.5 IW: 22 Recl D: 62.5 TV Recl: 56 Wall Clr: 12

Weight: 95 / 95 lbs Cube: 34.38

Standard Pillows: N/A Finish Required: N

Standard Cushions: Repose Standard Finish: BRUSHED NICKEL

COL: 124 square feet

Features a motion control switch on the outside of the left side facing arm and a Metal Prong Base in Brushed Nickel.

1	2	3	4	5	6	8	COL	S Nail	M Nail
5475	5670	5865	6060	6255	6450	8160	4317	N/A	N/A

L-465C-MR

PELLE PROVISIONS

Margo Manual Recliner

Manual Push Back Recline

Width: 31.5 Depth: 33.25 Height: 39.75

AH: 23.75 SH: 20.75 SD: 18 IW: 22 Recl D: 67 TV Recl: 57 Wall Clr: 12

Weight: 99 / 99 lbs Cube: 24.09

Standard Pillows: N/A Finish Required: Y

Standard Cushions: Repose Standard Finish: N/A

COL: 130 square feet

1	2	3	4	5	6	8	COL	S Nail	M Nail
5100	5295	5490	5685	5880	6075	7860	3792	N/A	N/A

L-465C-PR

PELLE PROVISIONS

Margo Power Recliner

Leather

Width: 31.5 Depth: 33.25 Height: 39.75

AH: 23.75 SH: 20.75 SD: 18 IW: 22 Recl D: 67 TV Recl: 57 Wall Clr: 12

Weight: 99 / 99 lbs Cube: 24.09

Standard Pillows: N/A Finish Required: Y

Standard Cushions: Repose Standard Finish: N/A

COL: 130 square feet

1	2	3	4	5	6	8	COL	S Nail	M Nail
5550	5745	5940	6135	6330	6525	8310	4242	N/A	N/A

LEATHER

L-465P-MR-1

PELLE PROVISIONS

Margo Manual Recliner with Swivel Five Prong Base

Manual Push Back Swivel Recline with Five Prong Base

Width: 31.5 Depth: 33.25 Height: 39.75

AH: 23.75 SH: 20.75 SD: 18 IW: 22 Recl D: 67 TV Recl: 57 Wall Clr: 12

Weight: 99 / 99 lbs Cube: 24.09

Standard Pillows: N/A Finish Required: N

Standard Cushions: Repose Standard Finish: Bronze

COL: 130 square feet

Metal Prong Base in Bronze

1	2	3	4	5	6	8	COL	S Nail	M Nail
5400	5595	5790	5985	6180	6375	8160	3942	N/A	N/A

L-465P-MR-2

PELLE PROVISIONS

Margo Manual Recliner with Swivel Five Prong Base

Manual Push Back Swivel Recline with Five Prong Base

Width: 31.5 Depth: 33.25 Height: 39.75

AH: 23.75 SH: 20.75 SD: 18 IW: 22 Recl D: 67 TV Recl: 57 Wall Clr: 12

Weight: 99 / 99 lbs Cube: 24.09

Standard Pillows: N/A Finish Required: N

Standard Cushions: Repose Standard Finish: BRUSHED NICKEL

COL: 130 square feet

Metal Prong Base in Brushed Nickel

1	2	3	4	5	6	8	COL	S Nail	M Nail
5400	5595	5790	5985	6180	6375	8160	3942	N/A	N/A

L-465P-PR-2

PELLE PROVISIONS

Margo Power Recliner with Swivel Five Prong Base

Power Swivel Recline with Five Prong Base

Width: 31.5 Depth: 33.25 Height: 39.75

AH: 23.75 SH: 20.75 SD: 18 IW: 22 Recl D: 67 TV Recl: 0 Wall Clr: 12

Weight: 99 / 99 lbs Cube: 24.09

Standard Pillows: N/A Finish Required: N

Standard Cushions: Repose Standard Finish: BRUSHED NICKEL

COL: 130 square feet

Metal Prong Base in Brushed Nickel

1	2	3	4	5	6	8	COL	S Nail	M Nail
5850	6045	6240	6435	6630	6825	8610	4392	N/A	N/A

L-466C-MR

PELLE PROVISIONS

Wyndham Manual Recliner

Manual Push Back Recliner

Width: 28.25 Depth: 33.75 Height: 41

AH: 26 SH: 18.5 SD: 22 IW: 24 Recl D: 65 TV Recl: 57 Wall Clr: 18

Weight: 69 / 85 lbs Cube: 41.32

Standard Pillows: N/A Finish Required: Y

Standard Cushions: High Resiliency 20 Standard Finish: N/A

COL: 79 square feet

1	2	3	4	5	6	8	COL	S Nail	M Nail
4050	4170	4290	4410	4530	4650	5745	3096	N/A	N/A

L-467C-MR

LIBBY LANGDON FOR FAIRFIELD, RECLINATION, PELLE PROV

Halsey Grande Manual Recliner

Manual Push Back Recliner

Width: 29.75 Depth: 35 Height: 42.75

AH: 26 SH: 20.5 SD: 19.5 IW: 22.5 Recl D: 66 TV Recl: 58 Wall Clr: 16

Weight: 125 / 125 lbs Cube: 25.76

Standard Pillows: N/A Finish Required: Y

Standard Cushions: High Resiliency 20 Standard Finish: N/A

COL: 135 square feet

1	2	3	4	5	6	8	COL	S Nail	M Nail
5175	5385	5595	5805	6015	6225	8085	3843	60	N/A

L-468C-MR

PELLE PROVISIONS

Ansleigh Manual Recliner

Manual Push Back Recline

Width: 28.25 Depth: 33.75 Height: 41

AH: 26 SH: 18.5 SD: 22 IW: 24 Recl D: 65 TV Recl: 57 Wall Clr: 18

Weight: 69 / 85 lbs Cube: 43.25

Standard Pillows: N/A Finish Required: Y

Standard Cushions: High Resiliency 20 Standard Finish: N/A

COL: 74 square feet

1	2	3	4	5	6	8	COL	S Nail	M Nail
3975	4095	4215	4335	4455	4575	5595	3096	N/A	N/A

L-469C-MR

PELLE PROVISIONS

Halsey Manual Recliner

Manual Push Back Recliner

Width: 29.75 Depth: 35 Height: 39.75

AH: 26 SH: 20.5 SD: 19.5 IW: 22.5 Recl D: 66 TV Recl: 58 Wall Clr: 16

Weight: 88 / 104 lbs Cube: 41.32

Standard Pillows: N/A Finish Required: Y

Standard Cushions: High Resiliency 20 Standard Finish: N/A

COL: 124 square feet

1	2	3	4	5	6	8	COL	S Nail	M Nail
5025	5220	5415	5610	5805	6000	7710	3768	60	N/A

LEATHER

L-469C-PR

PELLE PROVISIONS

Halsey Power Recliner

Power Recline

Width: 29.75 Depth: 35 Height: 39.75

AH: 26 SH: 20.5 SD: 19.5 IW: 22.5 Recl D: 66 TV Recl: 0 Wall Clr: 16

Weight: 88 / 107 lbs Cube: 43.25

Standard Pillows: N/A Finish Required: Y

Standard Cushions: High Resiliency 20 Standard Finish: N/A

COL: 124 square feet

1	2	3	4	5	6	8	COL	S Nail	M Nail
5475	5670	5865	6060	6255	6450	8160	4218	60	N/A

L-470C-MR-2

PELLE PROVISIONS

Infinity Manual Recliner

Manual Push Back Recliner

Width: 28.25 Depth: 33.75 Height: 41

AH: 26 SH: 18.5 SD: 22 IW: 24 Recl D: 65 TV Recl: 57 Wall Clr: 18

Weight: 69 / 85 lbs Cube: 43.25

Standard Pillows: N/A Finish Required: N

Standard Cushions: High Resiliency 20 Standard Finish: BRUSHED NICKEL

COL: 79 square feet

Metal Base in Nickel

1	2	3	4	5	6	8	COL	S Nail	M Nail
4575	4695	4815	4935	5055	5175	6270	3471	N/A	N/A

L-470C-MR-6

RECLINATION, PELLE PROVISIONS

Infinity Manual Recliner

Leather, Brushed Brass

Width: 28.25 Depth: 33.75 Height: 41

AH: 26 SH: 18.5 SD: 22 IW: 24 Recl D: 65 TV Recl: 57 Wall Clr: 18

Weight: 69 / 88 lbs Cube: 43.25

Standard Pillows: N/A Finish Required: N

Standard Cushions: High Resiliency 20 Standard Finish: BRUSHED BRASS

COL: 79 square feet

Metal Base in Brushed Brass

1	2	3	4	5	6	8	COL	S Nail	M Nail
4575	4695	4815	4935	5055	5175	6270	3471	N/A	N/A

L-471C-MR

PELLE PROVISIONS

Bridgett Manual Recliner

Leather

Width: 27 Depth: 33 Height: 43.5

AH: 26 SH: 19 SD: 20 IW: 21.5 Recl D: 64 TV Recl: 64 Wall Clr: 19.75

Weight: 90 / 106 lbs Cube: 41.32

Standard Pillows: N/A Finish Required: Y

Standard Cushions: High Resiliency 35 Standard Finish: N/A

COL: 68 square feet

Metal Base in Brushed Nickel

1	2	3	4	5	6	8	COL	S Nail	M Nail
3600	3705	3810	3915	4020	4125	5070	2796	N/A	N/A

L-476C-MR

PELLE PROVISIONS

Harrisburg Manual Recliner

Width: 32.25 Depth: 37.25 Height: 43.5

AH: 26.5 SH: 20 SD: 18 IW: 22 Recl D: 68 TV Recl: 59.25 Wall Clr: 18

Weight: 88 / 95 lbs Cube: 34.38

Standard Pillows: N/A Finish Required: Y

Standard Cushions: High Resiliency 20 Standard Finish: N/A

COL: 147 square feet

1	2	3	4	5	6	8	COL	S Nail	M Nail
5250	5475	5700	5925	6150	6375	8400	3792	N/A	N/A

L-476C-PR

PELLE PROVISIONS

Harrisburg Power Recliner

Width: 32.25 Depth: 37.25 Height: 43.5

AH: 26.5 SH: 20 SD: 18 IW: 22 Recl D: 68 TV Recl: 59.25 Wall Clr: 18

Weight: 88 / 106 lbs Cube: 43.25

Standard Pillows: N/A Finish Required: Y

Standard Cushions: High Resiliency 20 Standard Finish: N/A

COL: 147 square feet

Features a motion control switch on the outside of the left side facing arm.

1	2	3	4	5	6	8	COL	S Nail	M Nail
5700	5925	6150	6375	6600	6825	8850	4242	N/A	N/A

L-5026-C7

Darien Counter Stool

Width: 21 Depth: 24.5 Height: 40.5

AH: - SH: 26.5 SD: 19.5 IW: 21

Weight: 22 / 30 lbs Cube: 12.05

Standard Pillows: N/A Finish Required: Y

Standard Cushions: High Resiliency 40 Standard Finish: N/A

COL: 45 square feet

1	2	3	4	5	6	8	COL	S Nail	M Nail
2085	2160	2235	2310	2385	2460	3090	1512	45	N/A

LEATHER

L-5026-S4

Darien Side Chair with four casters

Standard Pillows: N/A **Finish Required:** Y
Standard Cushions: High Resiliency 40 **Standard Finish:** N/A
COL: 43.2 square feet

Width: 21 **Depth:** 24.5 **Height:** 34
AH: - **SH:** 20 **SD:** 19.5 **IW:** 21
Weight: 25 / 30 lbs **Cube:** 10.12

1 2085	2 2160	3 2235	4 2310	5 2385	6 2460	8 3060	COL 1422	S Nail 45	M Nail N/A
------------------	------------------	------------------	------------------	------------------	------------------	------------------	--------------------	---------------------	----------------------

L-5026-05

Darien Side Chair

Standard Pillows: N/A **Finish Required:** Y
Standard Cushions: High Resiliency 40 **Standard Finish:** N/A
COL: 45 square feet

Width: 21 **Depth:** 24.5 **Height:** 34
AH: - **SH:** 20 **SD:** 19.5 **IW:** 21
Weight: 25 / 30 lbs **Cube:** 10.12

1 1995	2 2070	3 2145	4 2220	5 2295	6 2370	8 3000	COL 1422	S Nail 45	M Nail N/A
------------------	------------------	------------------	------------------	------------------	------------------	------------------	--------------------	---------------------	----------------------

L-5026-07

Darien Bar Stool

Standard Pillows: N/A **Finish Required:** Y
Standard Cushions: High Resiliency 40 **Standard Finish:** N/A
COL: 45 square feet

Width: 21 **Depth:** 24.5 **Height:** 44.5
AH: - **SH:** 30.5 **SD:** 19.5 **IW:** 21
Weight: 22 / 30 lbs **Cube:** 13.24

1 2085	2 2160	3 2235	4 2310	5 2385	6 2460	8 3090	COL 1512	S Nail 45	M Nail N/A
------------------	------------------	------------------	------------------	------------------	------------------	------------------	--------------------	---------------------	----------------------

L-5035-C7

Orleans Counter Stool

Standard Pillows: N/A **Finish Required:** Y
Standard Cushions: High Resiliency 40 **Standard Finish:** N/A
COL: 40 square feet

Width: 19 **Depth:** 20 **Height:** 37.5
AH: - **SH:** 25.5 **SD:** 18 **IW:** 19
Weight: 30 / 40 lbs **Cube:** 15.74

1 1815	2 1875	3 1935	4 1995	5 2055	6 2115	8 2670	COL 1368	S Nail 45	M Nail N/A
------------------	------------------	------------------	------------------	------------------	------------------	------------------	--------------------	---------------------	----------------------

L-5035-07

PELLE PROVISIONS

Orleans Bar Stool

Standard Pillows: N/A **Finish Required:** Y
Standard Cushions: High Resiliency 40 **Standard Finish:** N/A
COL: 40 square feet

Width: 19 **Depth:** 20 **Height:** 41.5
AH: - **SH:** 29.5 **SD:** 18 **IW:** 19
Weight: 30 / 41 lbs **Cube:** 17.77

1 1815	2 1875	3 1935	4 1995	5 2055	6 2115	8 2670	COL 1368	S Nail 45	M Nail N/A
------------------	------------------	------------------	------------------	------------------	------------------	------------------	--------------------	---------------------	----------------------

L-5049-A2

Dilworth Arm Chair

Standard Pillows: N/A **Finish Required:** Y
Standard Cushions: High Resiliency 40 **Standard Finish:** N/A
COL: 40 square feet

Width: 22.5 **Depth:** 23.5 **Height:** 35.5
AH: 25.5 **SH:** 19 **SD:** 19.5 **IW:** 19
Weight: 30 / 40 lbs **Cube:** 10.86

1 2010	2 2070	3 2130	4 2190	5 2250	6 2310	8 2865	COL 1398	S Nail 45	M Nail 60
------------------	------------------	------------------	------------------	------------------	------------------	------------------	--------------------	---------------------	---------------------

L-5049-A4

Dilworth Arm Chair

Standard Pillows: N/A **Finish Required:** Y
Standard Cushions: High Resiliency 40 **Standard Finish:** N/A
COL: 40 square feet

Width: 22.5 **Depth:** 23.5 **Height:** 35.5
AH: 25.5 **SH:** 19 **SD:** 19.5 **IW:** 19
Weight: 30 / 40 lbs **Cube:** 10.86

1 2055	2 2115	3 2175	4 2235	5 2295	6 2355	8 2910	COL 1398	S Nail 45	M Nail 60
------------------	------------------	------------------	------------------	------------------	------------------	------------------	--------------------	---------------------	---------------------

LEATHER

L-5049-C7

Standard Pillows: N/A **Finish Required:** Y
Standard Cushions: High Resiliency 40 **Standard Finish:** N/A
COL: 40 square feet

Dilworth Counter Stool

Width: 19.5 **Depth:** 22 **Height:** 37
AH: - **SH:** 26 **SD:** 19 **IW:** 19.5
Weight: 21 / 31 lbs **Cube:** 15.74

1 1980	2 2040	3 2100	4 2160	5 2220	6 2280	8 2835	COL 1503	S Nail 45	M Nail 60
------------------	------------------	------------------	------------------	------------------	------------------	------------------	--------------------	---------------------	---------------------

L-5049-04

Standard Pillows: N/A **Finish Required:** Y
Standard Cushions: High Resiliency 40 **Standard Finish:** N/A
COL: 40 square feet

Dilworth Arm Chair

Width: 22.5 **Depth:** 23.5 **Height:** 35.5
AH: 25.5 **SH:** 19 **SD:** 19.5 **IW:** 19
Weight: 30 / 40 lbs **Cube:** 10.86

1 1980	2 2040	3 2100	4 2160	5 2220	6 2280	8 2835	COL 1398	S Nail 45	M Nail 60
------------------	------------------	------------------	------------------	------------------	------------------	------------------	--------------------	---------------------	---------------------

L-5049-05

Standard Pillows: N/A **Finish Required:** Y
Standard Cushions: High Resiliency 40 **Standard Finish:** N/A
COL: 40 square feet

Dilworth Side Chair

Width: 19 **Depth:** 23 **Height:** 35.5
AH: - **SH:** 19 **SD:** 19 **IW:** 19
Weight: 20 / 30 lbs **Cube:** 8.97

1 1860	2 1920	3 1980	4 2040	5 2100	6 2160	8 2715	COL 1368	S Nail 45	M Nail 60
------------------	------------------	------------------	------------------	------------------	------------------	------------------	--------------------	---------------------	---------------------

L-5049-07

Standard Pillows: N/A **Finish Required:** Y
Standard Cushions: High Resiliency 40 **Standard Finish:** N/A
COL: 40 square feet

Dilworth Bar Stool

Width: 19.5 **Depth:** 22 **Height:** 41
AH: - **SH:** 30 **SD:** 19 **IW:** 19.5
Weight: 22 / 34 lbs **Cube:** 10.17

1 1980	2 2040	3 2100	4 2160	5 2220	6 2280	8 2835	COL 1503	S Nail 45	M Nail 60
------------------	------------------	------------------	------------------	------------------	------------------	------------------	--------------------	---------------------	---------------------

L-5072-05

Standard Pillows: N/A **Finish Required:** Y
Standard Cushions: High Resiliency 40 **Standard Finish:** N/A
COL: 51 square feet

Gavin Side Chair

Width: 22 **Depth:** 24.5 **Height:** 36
AH: - **SH:** 18 **SD:** 19.5 **IW:** 20
Weight: 23 / 33 lbs **Cube:** 11.22

1 2220	2 2295	3 2370	4 2445	5 2520	6 2595	8 3300	COL 1572	S Nail 45	M Nail N/A
------------------	------------------	------------------	------------------	------------------	------------------	------------------	--------------------	---------------------	----------------------

L-5094-C7

Standard Pillows: N/A **Finish Required:** Y
Standard Cushions: High Resiliency 40 **Standard Finish:** N/A
COL: 40 square feet

Roxanne Counter Stool

Width: 20 **Depth:** 21 **Height:** 38.5
AH: - **SH:** 26.5 **SD:** 16 **IW:** 20
Weight: 22 / 32 lbs **Cube:** 9.35

1 1815	2 1875	3 1935	4 1995	5 2055	6 2115	8 2670	COL 1353	S Nail 45	M Nail N/A
------------------	------------------	------------------	------------------	------------------	------------------	------------------	--------------------	---------------------	----------------------

L-5094-07

PELLE PROVISIONS
Roxanne Bar Stool

Standard Pillows: N/A **Finish Required:** Y
Standard Cushions: High Resiliency 40 **Standard Finish:** N/A
COL: 40 square feet

Width: 20 **Depth:** 21 **Height:** 42.5
AH: - **SH:** 30 **SD:** 16 **IW:** 20
Weight: 22 / 33 lbs **Cube:** 17.77

1 1815	2 1875	3 1935	4 1995	5 2055	6 2115	8 2670	COL 1353	S Nail 45	M Nail N/A
------------------	------------------	------------------	------------------	------------------	------------------	------------------	--------------------	---------------------	----------------------

LEATHER

L-5095-C6

Standard Pillows: N/A **Finish Required:** Y
Standard Cushions: High Resilency 40 **Standard Finish:** N/A
COL: 34 square feet

Ramsey Counter Stool

Width: 22 **Depth:** 21.5 **Height:** 38.5
AH: 29.5 **SH:** 24 **SD:** 17.5 **IW:** 18
Weight: 30 / 35 lbs **Cube:** 10.53

1 1635	2 1695	3 1755	4 1815	5 1875	6 1935	8 2400	COL 1308	S Nail 45	M Nail 60
------------------	------------------	------------------	------------------	------------------	------------------	------------------	--------------------	---------------------	---------------------

L-5198-A2

Standard Pillows: N/A **Finish Required:** Y
Standard Cushions: High Resilency 40 **Standard Finish:** N/A
COL: 38.7 square feet

Warwick Occasional Chair

Width: 23.5 **Depth:** 26.5 **Height:** 35
AH: 25.5 **SH:** 17.5 **SD:** 19 **IW:** 18
Weight: 35 / 40 lbs **Cube:** 12.61

1 1935	2 1995	3 2055	4 2115	5 2175	6 2235	8 2775	COL 1386	S Nail 45	M Nail 60
------------------	------------------	------------------	------------------	------------------	------------------	------------------	--------------------	---------------------	---------------------

L-5198-A4

Standard Pillows: N/A **Finish Required:** Y
Standard Cushions: High Resilency 40 **Standard Finish:** N/A
COL: 38.7 square feet

Warwick Occasional Chair

Width: 23.5 **Depth:** 26.5 **Height:** 36
AH: 25.5 **SH:** 17.5 **SD:** 19 **IW:** 18
Weight: 35 / 40 lbs **Cube:** 12.97

1 1965	2 2025	3 2085	4 2145	5 2205	6 2265	8 2805	COL 1386	S Nail 45	M Nail 60
------------------	------------------	------------------	------------------	------------------	------------------	------------------	--------------------	---------------------	---------------------

L-5198-01

Standard Pillows: N/A **Finish Required:** Y
Standard Cushions: High Resilency 40 **Standard Finish:** N/A
COL: 38.7 square feet

Warwick Occasional Chair

Width: 23.5 **Depth:** 26.5 **Height:** 35
AH: 25.5 **SH:** 17.5 **SD:** 19 **IW:** 18
Weight: 35 / 40 lbs **Cube:** 12.61

1 1875	2 1935	3 1995	4 2055	5 2115	6 2175	8 2715	COL 1386	S Nail 45	M Nail 60
------------------	------------------	------------------	------------------	------------------	------------------	------------------	--------------------	---------------------	---------------------

L-5204-01

PELLE PROVISIONS

Standard Pillows: N/A **Finish Required:** Y
Standard Cushions: High Resilency 30 **Standard Finish:** N/A
COL: 54.4 square feet

Norton Occasional Chair

Width: 28 **Depth:** 29.5 **Height:** 35
AH: 24.5 **SH:** 20 **SD:** 21 **IW:** 21
Weight: 35 / 40 lbs **Cube:** 19.01

1 2430	2 2520	3 2610	4 2700	5 2790	6 2880	8 3630	COL 1746	S Nail Std.	M Nail N/A
------------------	------------------	------------------	------------------	------------------	------------------	------------------	--------------------	-----------------------	----------------------

L-5410-A4

Standard Pillows: N/A **Finish Required:** Y
Standard Cushions: High Resilency 40 **Standard Finish:** N/A
COL: 45 square feet

Allen Occasional Chair

Width: 25 **Depth:** 27 **Height:** 37.5
AH: 26.5 **SH:** 20.5 **SD:** 20 **IW:** 18
Weight: 35 / 40 lbs **Cube:** 14.64

1 1995	2 2070	3 2145	4 2220	5 2295	6 2370	8 3000	COL 1482	S Nail Std.	M Nail N/A
------------------	------------------	------------------	------------------	------------------	------------------	------------------	--------------------	-----------------------	----------------------

L-5418-04

Standard Pillows: N/A **Finish Required:** Y
Standard Cushions: High Resilency 40 **Standard Finish:** N/A
COL: 62 square feet

Sabine Arm Chair

Width: 26.5 **Depth:** 26.5 **Height:** 39
AH: 24.25 **SH:** 20 **SD:** 20.25 **IW:** 22.5
Weight: 25 / 28 lbs **Cube:** 15.84

1 2835	2 2940	3 3045	4 3150	5 3255	6 3360	8 4215	COL 2226	S Nail N/A	M Nail N/A
------------------	------------------	------------------	------------------	------------------	------------------	------------------	--------------------	----------------------	----------------------

LEATHER

L-5424-A2

Kilgore Arm Chair

Standard Pillows: N/A Finish Required: Y
 Standard Cushions: High Resiliency 40 Standard Finish: N/A
 COL: 34.2 square feet

Width: 24 Depth: 23 Height: 37.5
 AH: 24 SH: 20 SD: 18.5 IW: 21
 Weight: 30 / 35 lbs Cube: 11.97

1	2	3	4	5	6	8	COL	S Nail	M Nail
1830	1890	1950	2010	2070	2130	2610	1458	N/A	N/A

L-5432-A2

Chatham Arm Chair

Standard Pillows: N/A Finish Required: Y
 Standard Cushions: High Resiliency 55 Standard Finish: N/A
 COL: 34.2 square feet

Width: 23 Depth: 24.5 Height: 37.5
 AH: 24.5 SH: 19.5 SD: 18.5 IW: 20
 Weight: 30 / 35 lbs Cube: 12.22

1	2	3	4	5	6	8	COL	S Nail	M Nail
1665	1725	1785	1845	1905	1965	2445	1203	45	N/A

L-5432-A4

Chatham Arm Chair

Standard Pillows: N/A Finish Required: Y
 Standard Cushions: High Resiliency 55 Standard Finish: N/A
 COL: 34.2 square feet

Width: 23 Depth: 24 Height: 37.5
 AH: 24.5 SH: 19.5 SD: 19 IW: 18.5
 Weight: 30 / 35 lbs Cube: 11.97

1	2	3	4	5	6	8	COL	S Nail	M Nail
1710	1770	1830	1890	1950	2010	2490	1203	45	N/A

L-5432-04

Chatham Arm Chair

Standard Pillows: N/A Finish Required: Y
 Standard Cushions: High Resiliency 55 Standard Finish: N/A
 COL: 34.2 square feet

Width: 23 Depth: 24 Height: 37.5
 AH: 24.5 SH: 19.5 SD: 19 IW: 18.5
 Weight: 30 / 35 lbs Cube: 11.97

1	2	3	4	5	6	8	COL	S Nail	M Nail
1635	1695	1755	1815	1875	1935	2415	1203	45	N/A

L-5434-A2

Delano Arm Chair

Standard Pillows: N/A Finish Required: Y
 Standard Cushions: High Resiliency 55 Standard Finish: N/A
 COL: 34.2 square feet

Width: 24 Depth: 27 Height: 38
 AH: 25.5 SH: 19 SD: 20 IW: 20.5
 Weight: 30 / 35 lbs Cube: 14.25

1	2	3	4	5	6	8	COL	S Nail	M Nail
1740	1800	1860	1920	1980	2040	2520	1248	45	N/A

L-5434-A4

Delano Arm Chair

Standard Pillows: N/A Finish Required: Y
 Standard Cushions: High Resiliency 55 Standard Finish: N/A
 COL: 34.2 square feet

Width: 24 Depth: 27 Height: 38
 AH: 25.5 SH: 19 SD: 20 IW: 20.5
 Weight: 35 / 40 lbs Cube: 14.25

1	2	3	4	5	6	8	COL	S Nail	M Nail
1785	1845	1905	1965	2025	2085	2565	1248	45	N/A

L-5434-04

Delano Arm Chair

Standard Pillows: N/A Finish Required: Y
 Standard Cushions: High Resiliency 55 Standard Finish: N/A
 COL: 34.2 square feet

Width: 23 Depth: 24 Height: 37.5
 AH: 25.5 SH: 19 SD: 20 IW: 20.5
 Weight: 30 / 35 lbs Cube: 11.97

1	2	3	4	5	6	8	COL	S Nail	M Nail
1695	1755	1815	1875	1935	1995	2475	1248	45	N/A

LEATHER

L-5474-05

Bartow Side Chair

Standard Pillows: N/A **Finish Required:** Y
Standard Cushions: High Resiliency 40 **Standard Finish:** N/A
COL: 51 square feet

Width: 24 **Depth:** 30 **Height:** 46.5
AH: - **SH:** 20 **SD:** 19 **IW:** 24
Weight: 30 / 40 lbs **Cube:** 19.37

1	2	3	4	5	6	8	COL	S Nail	M Nail
2265	2340	2415	2490	2565	2640	3345	1452	Std.	15

L-5493-01

PELLE PROVISIONS

Silvio Occasional Chair

Leather

Standard Pillows: N/A **Finish Required:** Y
Standard Cushions: High Resiliency 35 **Standard Finish:** N/A
COL: 45 square feet
 Features natural cane accents that was handwoven using the peel of natural rattan. As with any natural product, natures imperfections and hallmarks will be present in the cane materials. Cane is a handcrafted product with artisanal origins dating back to

Width: 27 **Depth:** 31.75 **Height:** 35.5
AH: 24 **SH:** 20.5 **SD:** 18.75 **IW:** 22.25
Weight: 40 / 40 lbs **Cube:** 17.61

1	2	3	4	5	6	8	COL	S Nail	M Nail
2475	2550	2625	2700	2775	2850	3480	1947	N/A	N/A

L-5706-40

Leland Settee

Standard Pillows: N/A **Finish Required:** Y
Standard Cushions: Ultra Plush **Standard Finish:** N/A
COL: 158.1 square feet

Width: 54.5 **Depth:** 36 **Height:** 35
AH: 25 **SH:** 21.5 **SD:** 24 **IW:** 45
Weight: 75 / 102 lbs **Cube:** 39.73

1	2	3	4	5	6	8	COL	S Nail	M Nail
4785	5025	5265	5505	5745	5985	8160	3240	60	75

L-6001-A4

Lawrence Arm Chair

Standard Pillows: N/A **Finish Required:** Y
Standard Cushions: High Resiliency 40 **Standard Finish:** N/A
COL: 70 square feet

Width: 24.5 **Depth:** 30 **Height:** 42.5
AH: 26 **SH:** 20.5 **SD:** 20.5 **IW:** 20.5
Weight: 35 / 45 lbs **Cube:** 18.07

1	2	3	4	5	6	8	COL	S Nail	M Nail
2550	2655	2760	2865	2970	3075	4035	1746	45	60

L-6001-01

Lawrence Arm Chair

Standard Pillows: N/A **Finish Required:** Y
Standard Cushions: High Resiliency 40 **Standard Finish:** N/A
COL: 63 square feet

Width: 24.5 **Depth:** 30 **Height:** 42.5
AH: 26 **SH:** 20.5 **SD:** 20.5 **IW:** 20.5
Weight: 35 / 48 lbs **Cube:** 18.07

1	2	3	4	5	6	8	COL	S Nail	M Nail
2475	2580	2685	2790	2895	3000	3870	1746	45	60

L-6007-A2

PELLE PROVISIONS

Niobi Arm Chair

Two Casters, Clean Out Seat

Standard Pillows: N/A **Finish Required:** Y
Standard Cushions: High Resiliency 40 **Standard Finish:** N/A
COL: 57 square feet
 Features Clean Out at back of seat. Standard with 2 front casters and small nailhead trim

Width: 24.5 **Depth:** 23.5 **Height:** 33
AH: 25 **SH:** 19 **SD:** 18 **IW:** 20
Weight: 25 / 25 lbs **Cube:** 10.99

1	2	3	4	5	6	8	COL	S Nail	M Nail
2520	2610	2700	2790	2880	2970	3765	1992	N/A	N/A

L-6007-A4

PELLE PROVISIONS

Niobi Arm Chair

Four Casters, Clean Out Seat

Standard Pillows: N/A **Finish Required:** Y
Standard Cushions: High Resiliency 40 **Standard Finish:** N/A
COL: 57 square feet
 Features Clean Out at back of seat. Standard with 4 casters and small nailhead trim

Width: 24.5 **Depth:** 23.5 **Height:** 33
AH: 25 **SH:** 19 **SD:** 18 **IW:** 20
Weight: 25 / 25 lbs **Cube:** 10.99

1	2	3	4	5	6	8	COL	S Nail	M Nail
2550	2640	2730	2820	2910	3000	3795	1992	N/A	N/A

LEATHER

L-6007-04

PELLE PROVISIONS

Niobi Arm Chair

Clean Out Seat

Width: 24.5 Depth: 23.5 Height: 33

AH: 25 SH: 19 SD: 18 IW: 20

Weight: 25 / 25 lbs Cube: 10.99

Standard Pillows: N/A Finish Required: Y

Standard Cushions: High Resiliency 40 Standard Finish: N/A

COL: 57 square feet

Features Clean Out at back of seat. Standard with small nailhead trim

1	2	3	4	5	6	8	COL	S Nail	M Nail
2475	2565	2655	2745	2835	2925	3720	1992	N/A	N/A

L-6012-01

Layne Occasional Chair

Width: 31 Depth: 34 Height: 33

AH: 20 SH: 18 SD: 20.5 IW: 26.5

Weight: 31 / 44 lbs Cube: 20.12

Standard Pillows: N/A Finish Required: Y

Standard Cushions: High Resiliency 40 Standard Finish: N/A

COL: 62 square feet

1	2	3	4	5	6	8	COL	S Nail	M Nail
2940	3045	3150	3255	3360	3465	4320	2241	N/A	N/A

L-6013-05

Haines Side Chair

Width: 23 Depth: 28.5 Height: 42.5

AH: - SH: 20.5 SD: 18.5 IW: 23

Weight: 25 / 40 lbs Cube: 16.12

Standard Pillows: N/A Finish Required: Y

Standard Cushions: High Resiliency 30 Standard Finish: N/A

COL: 51 square feet

1	2	3	4	5	6	8	COL	S Nail	M Nail
2010	2085	2160	2235	2310	2385	3090	1680	45	60

L-6014-A2

Aiden Occasional Chair

Width: 26 Depth: 26.5 Height: 32

AH: 24 SH: 20 SD: 19.5 IW: 19

Weight: 29 / 42 lbs Cube: 12.75

Standard Pillows: N/A Finish Required: Y

Standard Cushions: High Resiliency 40 Standard Finish: N/A

COL: 59.5 square feet

1	2	3	4	5	6	8	COL	S Nail	M Nail
2265	2355	2445	2535	2625	2715	3540	1686	60	75

L-6014-A4

Aiden Occasional Chair

Width: 26 Depth: 26.5 Height: 32

AH: 24 SH: 20 SD: 19.5 IW: 19

Weight: 27 / 32 lbs Cube: 12.75

Standard Pillows: N/A Finish Required: Y

Standard Cushions: High Resiliency 40 Standard Finish: N/A

COL: 59.5 square feet

1	2	3	4	5	6	8	COL	S Nail	M Nail
2310	2400	2490	2580	2670	2760	3585	1686	60	75

L-6014-01

PELLE PROVISIONS

Aiden Occasional Chair

Width: 26 Depth: 26.5 Height: 32

AH: 24 SH: 20 SD: 19.5 IW: 19

Weight: 29 / 42 lbs Cube: 21.65

Standard Pillows: N/A Finish Required: Y

Standard Cushions: High Resiliency 40 Standard Finish: N/A

COL: 62 square feet

1	2	3	4	5	6	8	COL	S Nail	M Nail
2235	2340	2445	2550	2655	2760	3615	1686	60	75

L-6016-01

Lockport Occasional Chair

Width: 23.5 Depth: 25 Height: 32

AH: 25.5 SH: 19 SD: 20 IW: 19

Weight: 25 / 35 lbs Cube: 10.87

Standard Pillows: N/A Finish Required: Y

Standard Cushions: High Resiliency 40 Standard Finish: N/A

COL: 34.2 square feet

1	2	3	4	5	6	8	COL	S Nail	M Nail
1770	1830	1890	1950	2010	2070	2550	1338	N/A	N/A

LEATHER

L-6018-C7

Standard Pillows: N/A **Finish Required:** Y
Standard Cushions: High Resiliency 40 **Standard Finish:** N/A
COL: 57.6 square feet

Dora Counter Stool

Width: 20.5 **Depth:** 25 **Height:** 42
AH: - **SH:** 26.5 **SD:** 17.5 **IW:** 20.5
Weight: 30 / 41 lbs **Cube:** 12.45

1	2	3	4	5	6	8	COL	S Nail	M Nail
2295	2385	2475	2565	2655	2745	3540	1617	45	60

L-6018-05

Standard Pillows: N/A **Finish Required:** Y
Standard Cushions: High Resiliency 40 **Standard Finish:** N/A
COL: 74 square feet

Dora Side Chair

Width: 21 **Depth:** 29 **Height:** 44
AH: - **SH:** 21 **SD:** 18.5 **IW:** -
Weight: 30 / 45 lbs **Cube:** 15.5

1	2	3	4	5	6	8	COL	S Nail	M Nail
2490	2610	2730	2850	2970	3090	4110	1605	60	75

L-6018-07

Standard Pillows: N/A **Finish Required:** Y
Standard Cushions: High Resiliency 40 **Standard Finish:** N/A
COL: 57.6 square feet

Dora Bar Stool

Width: 20.5 **Depth:** 25 **Height:** 46
AH: - **SH:** 30.5 **SD:** 17.5 **IW:** 20.5
Weight: 25 / 30 lbs **Cube:** 13.64

1	2	3	4	5	6	8	COL	S Nail	M Nail
2295	2385	2475	2565	2655	2745	3540	1617	45	60

L-6022-C6

Standard Pillows: N/A **Finish Required:** Y
Standard Cushions: High Resiliency 40 **Standard Finish:** N/A
COL: 34.2 square feet

Gilroy Counter Stool

Width: 24 **Depth:** 24 **Height:** 39.5
AH: 32.5 **SH:** 26.5 **SD:** 19 **IW:** 19.5
Weight: 40 / 45 lbs **Cube:** 13.16

1	2	3	4	5	6	8	COL	S Nail	M Nail
1980	2040	2100	2160	2220	2280	2760	1608	Std.	N/A

L-6022-06

PELLE PROVISIONS

Gilroy Bar Stool

Standard Pillows: N/A **Finish Required:** Y
Standard Cushions: High Resiliency 40 **Standard Finish:** N/A
COL: 34.2 square feet

Width: 24 **Depth:** 24 **Height:** 43.5
AH: 36.5 **SH:** 30.5 **SD:** 19 **IW:** 19.5
Weight: 35 / 40 lbs **Cube:** 17.97

1	2	3	4	5	6	8	COL	S Nail	M Nail
1980	2040	2100	2160	2220	2280	2760	1608	Std.	N/A

L-6028-A2

Standard Pillows: N/A **Finish Required:** Y
Standard Cushions: High Resiliency 35 **Standard Finish:** N/A
COL: 48.6 square feet

Glenwood Occasional Chair

Width: 24.5 **Depth:** 24.5 **Height:** 35
AH: 26 **SH:** 20 **SD:** 18 **IW:** 19
Weight: 30 / 35 lbs **Cube:** 12.15

1	2	3	4	5	6	8	COL	S Nail	M Nail
2340	2415	2490	2565	2640	2715	3390	1677	45	60

L-6028-01

Standard Pillows: N/A **Finish Required:** Y
Standard Cushions: High Resiliency 35 **Standard Finish:** N/A
COL: 51 square feet

Glenwood Occasional Chair

Width: 24.5 **Depth:** 24.5 **Height:** 35
AH: 26 **SH:** 20 **SD:** 18 **IW:** 19
Weight: 30 / 35 lbs **Cube:** 12.15

1	2	3	4	5	6	8	COL	S Nail	M Nail
2295	2370	2445	2520	2595	2670	3375	1677	45	60

LEATHER

L-6029-A2

Brayden Occasional Chair

Standard Pillows: N/A **Finish Required:** N
Standard Cushions: N/A **Standard Finish:** N/A
COL: 53.1 square feet

Width: 0 **Depth:** 0 **Height:** 0
AH: - **SH:** - **SD:** - **IW:** -
Weight: 0 / 0 lbs **Cube:** 0

1 2445	2 2535	3 2625	4 2715	5 2805	6 2895	8 3630	COL 1800	S Nail N/A	M Nail N/A
------------------	------------------	------------------	------------------	------------------	------------------	------------------	--------------------	----------------------	----------------------

L-6029-A4

Brayden Occasional Chair

Standard Pillows: N/A **Finish Required:** Y
Standard Cushions: High Resiliency 40 **Standard Finish:** N/A
COL: 53.1 square feet

Width: 27 **Depth:** 29 **Height:** 31
AH: 26 **SH:** 18 **SD:** 21 **IW:** 24.5
Weight: 32 / 45 lbs **Cube:** 14.04

1 2490	2 2580	3 2670	4 2760	5 2850	6 2940	8 3675	COL 1800	S Nail N/A	M Nail N/A
------------------	------------------	------------------	------------------	------------------	------------------	------------------	--------------------	----------------------	----------------------

L-6029-01

Brayden Occasional Chair

Standard Pillows: N/A **Finish Required:** Y
Standard Cushions: High Resiliency 40 **Standard Finish:** N/A
COL: 53.1 square feet

Width: 27 **Depth:** 29 **Height:** 31
AH: 26 **SH:** 18 **SD:** 21 **IW:** 24.5
Weight: 32 / 45 lbs **Cube:** 14.04

1 2400	2 2490	3 2580	4 2670	5 2760	6 2850	8 3585	COL 1800	S Nail N/A	M Nail N/A
------------------	------------------	------------------	------------------	------------------	------------------	------------------	--------------------	----------------------	----------------------

L-6046-A2

Gresham Occasional Chair

Standard Pillows: N/A **Finish Required:** Y
Standard Cushions: High Resiliency 40 **Standard Finish:** N/A
COL: 62 square feet

Width: 28.5 **Depth:** 24.5 **Height:** 33
AH: 26 **SH:** 20 **SD:** 19 **IW:** 20
Weight: 25 / 55 lbs **Cube:** 13.33

1 2505	2 2610	3 2715	4 2820	5 2925	6 3030	8 3885	COL 1797	S Nail Std.	M Nail N/A
------------------	------------------	------------------	------------------	------------------	------------------	------------------	--------------------	-----------------------	----------------------

L-6046-A4

Gresham Occasional Chair

Standard Pillows: N/A **Finish Required:** Y
Standard Cushions: High Resiliency 40 **Standard Finish:** N/A
COL: 62 square feet

Width: 28.5 **Depth:** 24.5 **Height:** 33
AH: 26 **SH:** 20 **SD:** 19 **IW:** 20
Weight: 35 / 40 lbs **Cube:** 13.33

1 2550	2 2655	3 2760	4 2865	5 2970	6 3075	8 3930	COL 1797	S Nail Std.	M Nail N/A
------------------	------------------	------------------	------------------	------------------	------------------	------------------	--------------------	-----------------------	----------------------

L-6046-01

PELLE PROVISIONS

Gresham Occasional Chair

Standard Pillows: N/A **Finish Required:** Y
Standard Cushions: High Resiliency 40 **Standard Finish:** N/A
COL: 62 square feet

Width: 28.5 **Depth:** 24.5 **Height:** 33
AH: 26 **SH:** 20 **SD:** 19 **IW:** 20
Weight: 25 / 30 lbs **Cube:** 21.09

1 2475	2 2580	3 2685	4 2790	5 2895	6 3000	8 3855	COL 1797	S Nail Std.	M Nail N/A
------------------	------------------	------------------	------------------	------------------	------------------	------------------	--------------------	-----------------------	----------------------

L-6052-01

Jennings Occasional Chair

Standard Pillows: N/A **Finish Required:** Y
Standard Cushions: High Resiliency 30 **Standard Finish:** N/A
COL: 53.1 square feet

Width: 30.5 **Depth:** 29 **Height:** 29.5
AH: 24 **SH:** 17.5 **SD:** 22.5 **IW:** 26
Weight: 25 / 30 lbs **Cube:** 15.09

1 2325	2 2415	3 2505	4 2595	5 2685	6 2775	8 3510	COL 1647	S Nail 45	M Nail 60
------------------	------------------	------------------	------------------	------------------	------------------	------------------	--------------------	---------------------	---------------------

LEATHER

L-6053-01

Lindale Occasional Chair

Standard Pillows: N/A **Finish Required:** Y
Standard Cushions: High Resiliency 40 **Standard Finish:** N/A
COL: 68 square feet

Width: 23 **Depth:** 24 **Height:** 37.5
AH: 24.5 **SH:** 21 **SD:** 19 **IW:** 20
Weight: 30 / 35 lbs **Cube:** 11.97

1 2400	2 2505	3 2610	4 2715	5 2820	6 2925	8 3870	COL 1671	S Nail N/A	M Nail N/A
------------------	------------------	------------------	------------------	------------------	------------------	------------------	--------------------	----------------------	----------------------

L-6062-01

Lockhart Occasional Chair

Standard Pillows: N/A **Finish Required:** Y
Standard Cushions: High Resiliency 40 **Standard Finish:** N/A
COL: 62 square feet

Width: 25.5 **Depth:** 26 **Height:** 35.5
AH: 24.5 **SH:** 19 **SD:** 19 **IW:** 19
Weight: 35 / 40 lbs **Cube:** 13.62

1 2400	2 2505	3 2610	4 2715	5 2820	6 2925	8 3780	COL 1641	S Nail 45	M Nail 60
------------------	------------------	------------------	------------------	------------------	------------------	------------------	--------------------	---------------------	---------------------

L-6063-35

Jordan Office Swivel Chair

Standard Pillows: N/A **Finish Required:** Y
Standard Cushions: High Resiliency 40 **Standard Finish:** N/A
COL: 57.6 square feet
Standard with a gas lift.

Width: 26 **Depth:** 28 **Height:** 36
AH: - **SH:** - **SD:** 18 **IW:** 22
Weight: 30 / 35 lbs **Cube:** 15.16

1 2430	2 2520	3 2610	4 2700	5 2790	6 2880	8 3675	COL 1317	S Nail 45	M Nail 60
------------------	------------------	------------------	------------------	------------------	------------------	------------------	--------------------	---------------------	---------------------

L-6064-01

Laurens Occasional Chair

Standard Pillows: N/A **Finish Required:** Y
Standard Cushions: High Resiliency 30 **Standard Finish:** N/A
COL: 63.75 square feet

Width: 25.5 **Depth:** 28.5 **Height:** 41
AH: 27.5 **SH:** 20 **SD:** 19 **IW:** 19
Weight: 40 / 50 lbs **Cube:** 17.24

1 2490	2 2595	3 2700	4 2805	5 2910	6 3015	8 3900	COL 1701	S Nail 45	M Nail 60
------------------	------------------	------------------	------------------	------------------	------------------	------------------	--------------------	---------------------	---------------------

L-6068-A2

Keller Arm Chair

Standard Pillows: N/A **Finish Required:** Y
Standard Cushions: High Resiliency 40 **Standard Finish:** N/A
COL: 34.2 square feet

Width: 23.5 **Depth:** 24 **Height:** 31.5
AH: 24.5 **SH:** 19.5 **SD:** 20.5 **IW:** 20
Weight: 29 / 34 lbs **Cube:** 10.28

1 1770	2 1830	3 1890	4 1950	5 2010	6 2070	8 2550	COL 1338	S Nail 45	M Nail N/A
------------------	------------------	------------------	------------------	------------------	------------------	------------------	--------------------	---------------------	----------------------

L-6068-A4

Keller Arm Chair

Standard Pillows: N/A **Finish Required:** Y
Standard Cushions: High Resiliency 40 **Standard Finish:** N/A
COL: 34.2 square feet

Width: 23.5 **Depth:** 24 **Height:** 31.5
AH: 24.5 **SH:** 19.5 **SD:** 20.5 **IW:** 20
Weight: 30 / 35 lbs **Cube:** 10.28

1 1815	2 1875	3 1935	4 1995	5 2055	6 2115	8 2595	COL 1338	S Nail 45	M Nail N/A
------------------	------------------	------------------	------------------	------------------	------------------	------------------	--------------------	---------------------	----------------------

L-6068-C6

Keller Counter Stool

Standard Pillows: N/A **Finish Required:** Y
Standard Cushions: High Resiliency 40 **Standard Finish:** N/A
COL: 34.2 square feet

Width: 22.5 **Depth:** 22.5 **Height:** 39
AH: 32 **SH:** 26 **SD:** 19 **IW:** 19
Weight: 30 / 40 lbs **Cube:** 11.42

1 1905	2 1965	3 2025	4 2085	5 2145	6 2205	8 2685	COL 1503	S Nail 45	M Nail N/A
------------------	------------------	------------------	------------------	------------------	------------------	------------------	--------------------	---------------------	----------------------

LEATHER

L-6068-04

Keller Arm Chair

Standard Pillows: N/A **Finish Required:** Y
Standard Cushions: High Resiliency 40 **Standard Finish:** N/A
COL: 40 square feet

Width: 23.5 **Depth:** 24 **Height:** 31.5
AH: 24.5 **SH:** 19.5 **SD:** 20.5 **IW:** 20
Weight: 30 / 35 lbs **Cube:** 10.28

1 1740	2 1800	3 1860	4 1920	5 1980	6 2040	8 2595	COL 1338	S Nail 45	M Nail N/A
------------------	------------------	------------------	------------------	------------------	------------------	------------------	--------------------	---------------------	----------------------

L-6068-06

Keller Bar Stool

Standard Pillows: N/A **Finish Required:** Y
Standard Cushions: High Resiliency 40 **Standard Finish:** N/A
COL: 40 square feet

Width: 22.5 **Depth:** 22.5 **Height:** 43
AH: 36 **SH:** 30 **SD:** 19 **IW:** 19
Weight: 30 / 35 lbs **Cube:** 12.59

1 1905	2 1965	3 2025	4 2085	5 2145	6 2205	8 2760	COL 1503	S Nail 45	M Nail N/A
------------------	------------------	------------------	------------------	------------------	------------------	------------------	--------------------	---------------------	----------------------

L-6069-C7

Casey Counter Stool

Standard Pillows: N/A **Finish Required:** Y
Standard Cushions: High Resiliency 40 **Standard Finish:** N/A
COL: 53.1 square feet

Width: 21 **Depth:** 24.5 **Height:** 41
AH: - **SH:** 27 **SD:** 16.5 **IW:** 21
Weight: 26 / 31 lbs **Cube:** 12.2

1 1980	2 2070	3 2160	4 2250	5 2340	6 2430	8 3165	COL 1362	S Nail 45	M Nail 60
------------------	------------------	------------------	------------------	------------------	------------------	------------------	--------------------	---------------------	---------------------

L-6069-04

Casey Arm Chair

Standard Pillows: N/A **Finish Required:** Y
Standard Cushions: High Resiliency 40 **Standard Finish:** N/A
COL: 57.6 square feet

Width: 25 **Depth:** 25.5 **Height:** 38
AH: 26 **SH:** 20 **SD:** 17.5 **IW:** 22
Weight: 30 / 35 lbs **Cube:** 14.01

1 1995	2 2085	3 2175	4 2265	5 2355	6 2445	8 3240	COL 1317	S Nail 45	M Nail 60
------------------	------------------	------------------	------------------	------------------	------------------	------------------	--------------------	---------------------	---------------------

L-6069-05

Casey Side Chair

Standard Pillows: N/A **Finish Required:** Y
Standard Cushions: High Resiliency 40 **Standard Finish:** N/A
COL: 57.6 square feet

Width: 22.5 **Depth:** 25.5 **Height:** 38
AH: - **SH:** 20 **SD:** 17.5 **IW:** -
Weight: 25 / 30 lbs **Cube:** 12.61

1 1995	2 2085	3 2175	4 2265	5 2355	6 2445	8 3240	COL 1317	S Nail 45	M Nail 60
------------------	------------------	------------------	------------------	------------------	------------------	------------------	--------------------	---------------------	---------------------

L-6069-07

Casey Bar Stool

Standard Pillows: N/A **Finish Required:** Y
Standard Cushions: High Resiliency 40 **Standard Finish:** N/A
COL: 51 square feet

Width: 21 **Depth:** 24.5 **Height:** 45
AH: - **SH:** 31 **SD:** 16.5 **IW:** 21
Weight: 26 / 39 lbs **Cube:** 13.39

1 1980	2 2055	3 2130	4 2205	5 2280	6 2355	8 3060	COL 1362	S Nail 45	M Nail 60
------------------	------------------	------------------	------------------	------------------	------------------	------------------	--------------------	---------------------	---------------------

L-6079-A2

Brent Occasional Chair

Standard Pillows: N/A **Finish Required:** Y
Standard Cushions: High Resiliency 40 **Standard Finish:** N/A
COL: 57 square feet

Width: 27 **Depth:** 27 **Height:** 31.5
AH: 26.5 **SH:** 18.5 **SD:** 18.5 **IW:** 19.5
Weight: 31 / 36 lbs **Cube:** 13.28

1 2562	2 2652	3 2742	4 2832	5 2922	6 3012	8 3807	COL 1692	S Nail 60	M Nail 75
------------------	------------------	------------------	------------------	------------------	------------------	------------------	--------------------	---------------------	---------------------

LEATHER

L-6079-A4

Brent Occasional Chair

Standard Pillows: N/A **Finish Required:** Y
Standard Cushions: High Resiliency 40 **Standard Finish:** N/A
COL: 57 square feet

Width: 27 **Depth:** 27 **Height:** 31.5
AH: 26.5 **SH:** 18.5 **SD:** 18.5 **IW:** 19.5
Weight: 35 / 45 lbs **Cube:** 13.28

1	2	3	4	5	6	8	COL	S Nail	M Nail
2610	2700	2790	2880	2970	3060	3855	1692	60	75

L-6079-01

Brent Occasional Chair

Standard Pillows: N/A **Finish Required:** Y
Standard Cushions: High Resiliency 40 **Standard Finish:** N/A
COL: 57 square feet

Width: 27 **Depth:** 27 **Height:** 31.5
AH: 26.5 **SH:** 18.5 **SD:** 18.5 **IW:** 19.5
Weight: 35 / 45 lbs **Cube:** 13.28

1	2	3	4	5	6	8	COL	S Nail	M Nail
2520	2610	2700	2790	2880	2970	3765	1692	60	75

L-6080-A2

Danbury Barrel Occasional Chair

Standard Pillows: N/A **Finish Required:** Y
Standard Cushions: High Resiliency 40 **Standard Finish:** N/A
COL: 53.1 square feet

Width: 26 **Depth:** 25 **Height:** 33
AH: 26 **SH:** 19.5 **SD:** 20 **IW:** 21.5
Weight: 50 / 55 lbs **Cube:** 12.41

1	2	3	4	5	6	8	COL	S Nail	M Nail
2265	2355	2445	2535	2625	2715	3450	1602	Std.	N/A

L-6080-A4

Danbury Occasional Chair

Standard Pillows: N/A **Finish Required:** Y
Standard Cushions: High Resiliency 40 **Standard Finish:** N/A
COL: 53.1 square feet

Width: 26 **Depth:** 25 **Height:** 33
AH: 26 **SH:** 19.5 **SD:** 20 **IW:** 21.5
Weight: 50 / 55 lbs **Cube:** 12.41

1	2	3	4	5	6	8	COL	S Nail	M Nail
2310	2400	2490	2580	2670	2760	3495	1602	Std.	N/A

L-6080-01

PELLE PROVISIONS

Danbury Occasional Chair

Standard Pillows: N/A **Finish Required:** Y
Standard Cushions: High Resiliency 40 **Standard Finish:** N/A
COL: 51 square feet

Width: 26 **Depth:** 25 **Height:** 33.5
AH: 26 **SH:** 19.5 **SD:** 20 **IW:** 21.5
Weight: 50 / 55 lbs **Cube:** 19.01

1	2	3	4	5	6	8	COL	S Nail	M Nail
2235	2310	2385	2460	2535	2610	3315	1602	Std.	N/A

L-6085-01

PELLE PROVISIONS

Devin Occasional Chair

Standard Pillows: N/A **Finish Required:** Y
Standard Cushions: High Resiliency 40 **Standard Finish:** N/A
COL: 62 square feet

Width: 29.5 **Depth:** 33 **Height:** 35.5
AH: 24 **SH:** 19 **SD:** 21 **IW:** 20
Weight: 43 / 57 lbs **Cube:** 19.99

1	2	3	4	5	6	8	COL	S Nail	M Nail
2895	3000	3105	3210	3315	3420	4275	2196	N/A	N/A

L-6085-1N

Devin Task Chair

Standard Pillows: N/A **Finish Required:** N
Standard Cushions: High Resiliency 40 **Standard Finish:** Nickel
COL: 63 square feet
Features Swivel Nickel Base with Casters

Width: 26.5 **Depth:** 31 **Height:** 36.25
AH: 25.25 **SH:** 20 **SD:** 22 **IW:** 20
Weight: 39 / 52 lbs **Cube:** 23.89

1	2	3	4	5	6	8	COL	S Nail	M Nail
2895	3000	3105	3210	3315	3420	4290	2076	N/A	N/A

LEATHER

L-6085-2N

Devin Swivel Chair

Standard Pillows: N/A **Finish Required:** N
Standard Cushions: High Resiliency 40 **Standard Finish:** Nickel
COL: 63 square feet
 Features Stationary Nickel Plated Base with a gas cylinder.

Width: 26.5 **Depth:** 31 **Height:** 34.75
AH: 23.75 **SH:** 18.5 **SD:** 22 **IW:** 20
Weight: 39 / 52 lbs **Cube:** 16.52

1 2895	2 3000	3 3105	4 3210	5 3315	6 3420	8 4290	COL 2076	S Nail N/A	M Nail N/A
------------------	------------------	------------------	------------------	------------------	------------------	------------------	--------------------	----------------------	----------------------

L-6088-01

Lynnhaven Occasional Chair

Standard Pillows: N/A **Finish Required:** Y
Standard Cushions: High Resiliency 35 **Standard Finish:** N/A
COL: 62 square feet

Width: 26.5 **Depth:** 29.5 **Height:** 32.5
AH: 22 **SH:** 19 **SD:** 22 **IW:** 21
Weight: 29 / 42 lbs **Cube:** 14.7

1 2640	2 2745	3 2850	4 2955	5 3060	6 3165	8 4020	COL 2166	S Nail N/A	M Nail N/A
------------------	------------------	------------------	------------------	------------------	------------------	------------------	--------------------	----------------------	----------------------

L-6090-01

PELLE PROVISIONS
Lana Occasional Chair
 Leather

Standard Pillows: N/A **Finish Required:** Y
Standard Cushions: High Resiliency 50 **Standard Finish:** N/A
COL: 68 square feet
 Features a clean out back detail.

Width: 28.5 **Depth:** 24.5 **Height:** 30.5
AH: 23 **SH:** 18.5 **SD:** 22 **IW:** 21
Weight: 37 / 37 lbs **Cube:** 12.32

1 2685	2 2790	3 2895	4 3000	5 3105	6 3210	8 4155	COL 1971	S Nail 90	M Nail N/A
------------------	------------------	------------------	------------------	------------------	------------------	------------------	--------------------	---------------------	----------------------

L-6092-A2

Fiona Occasional Chair

Standard Pillows: N/A **Finish Required:** Y
Standard Cushions: High Resiliency 40 **Standard Finish:** N/A
COL: 68 square feet

Width: 0 **Depth:** 0 **Height:** 0
AH: - **SH:** - **SD:** - **IW:** -
Weight: 0 / 0 lbs **Cube:** 0

1 2925	2 3030	3 3135	4 3240	5 3345	6 3450	8 4395	COL 2010	S Nail 90	M Nail 105
------------------	------------------	------------------	------------------	------------------	------------------	------------------	--------------------	---------------------	----------------------

L-6092-A4

PELLE PROVISIONS
Fiona Occasional Chair

Standard Pillows: N/A **Finish Required:** Y
Standard Cushions: High Resiliency 40 **Standard Finish:** N/A
COL: 68 square feet

Width: 25 **Depth:** 28.25 **Height:** 34.5
AH: 24 **SH:** 19.25 **SD:** 19 **IW:** 18.5
Weight: 51 / 51 lbs **Cube:** 14.1

1 2970	2 3075	3 3180	4 3285	5 3390	6 3495	8 4440	COL 2010	S Nail 90	M Nail 105
------------------	------------------	------------------	------------------	------------------	------------------	------------------	--------------------	---------------------	----------------------

L-6092-01

PELLE PROVISIONS
Fiona Occasional Chair

Standard Pillows: N/A **Finish Required:** Y
Standard Cushions: High Resiliency 40 **Standard Finish:** N/A
COL: 68 square feet

Width: 25 **Depth:** 28.25 **Height:** 34.5
AH: 24 **SH:** 19.25 **SD:** 19 **IW:** 18.5
Weight: 51 / 51 lbs **Cube:** 14.1

1 2895	2 3000	3 3105	4 3210	5 3315	6 3420	8 4365	COL 2010	S Nail 90	M Nail 105
------------------	------------------	------------------	------------------	------------------	------------------	------------------	--------------------	---------------------	----------------------

L-6099-01

Kingston Occasional Chair

Standard Pillows: N/A **Finish Required:** Y
Standard Cushions: High Resiliency 40 **Standard Finish:** N/A
COL: 28.8 square feet

Width: 23 **Depth:** 23.5 **Height:** 34.5
AH: 26 **SH:** 20 **SD:** 18.5 **IW:** 19
Weight: 25 / 30 lbs **Cube:** 10.79

1 1575	2 1620	3 1665	4 1710	5 1755	6 1800	8 2205	COL 1248	S Nail N/A	M Nail N/A
------------------	------------------	------------------	------------------	------------------	------------------	------------------	--------------------	----------------------	----------------------

LEATHER

L-6100-C7

PELLE PROVISIONS

Harlow Side Chair

Leather

Width: 19.5 Depth: 23.5 Height: 38.75

AH: - SH: 24.5 SD: 19 IW: 19.5

Weight: 30 / 30 lbs Cube: 10.27

Standard Pillows: N/A Finish Required: Y

Standard Cushions: High Resiliency 40 Standard Finish: N/A

COL: 29 square feet

Features natural cane accents that was handwoven using the peel of natural rattan. As with any natural product, nature's imperfections and hallmarks will be present in the cane materials. Cane is a handcrafted product with artisanal origins dating back to

1	2	3	4	5	6	8	COL	S Nail	M Nail
1500	1545	1590	1635	1680	1725	2130	1218	N/A	N/A

L-6100-04

PELLE PROVISIONS

Harlow Arm Chair

Leather

Width: 23 Depth: 24 Height: 36.5

AH: 24 SH: 19.5 SD: 19 IW: 20

Weight: 21 / 21 lbs Cube: 11.65

Standard Pillows: N/A Finish Required: Y

Standard Cushions: High Resiliency 40 Standard Finish: N/A

COL: 29 square feet

Features natural cane accents that was handwoven using the peel of natural rattan. As with any natural product, nature's imperfections and hallmarks will be present in the cane materials. Cane is a handcrafted product with artisanal origins dating back to

1	2	3	4	5	6	8	COL	S Nail	M Nail
1455	1500	1545	1590	1635	1680	2085	1173	N/A	N/A

L-6100-05

PELLE PROVISIONS

Harlow Side Chair

Leather

Width: 20 Depth: 24 Height: 35.25

AH: - SH: 19.5 SD: 19 IW: 20

Weight: 16 / 16 lbs Cube: 9.79

Standard Pillows: N/A Finish Required: Y

Standard Cushions: High Resiliency 40 Standard Finish: N/A

COL: 29 square feet

Features natural cane accents that was handwoven using the peel of natural rattan. As with any natural product, nature's imperfections and hallmarks will be present in the cane materials. Cane is a handcrafted product with artisanal origins dating back to

1	2	3	4	5	6	8	COL	S Nail	M Nail
1425	1470	1515	1560	1605	1650	2055	1143	N/A	N/A

L-6100-07

PELLE PROVISIONS

Harlow Bar Stool

Leather

Width: 19.5 Depth: 23.5 Height: 44.75

AH: - SH: 30.5 SD: 19 IW: 19.5

Weight: 30 / 30 lbs Cube: 11.86

Standard Pillows: N/A Finish Required: Y

Standard Cushions: High Resiliency 40 Standard Finish: N/A

COL: 29 square feet

Features natural cane accents that was handwoven using the peel of natural rattan. As with any natural product, nature's imperfections and hallmarks will be present in the cane materials. Cane is a handcrafted product with artisanal origins dating back to

1	2	3	4	5	6	8	COL	S Nail	M Nail
1500	1545	1590	1635	1680	1725	2130	1218	N/A	N/A

L-6101-31

PELLE PROVISIONS

Barry Swivel Chair

Width: 33.5 Depth: 34.5 Height: 35

AH: 27 SH: 20.5 SD: 22 IW: 21

Weight: 60 / 70 lbs Cube: 29.69

Standard Pillows: N/A Finish Required: N

Standard Cushions: Ultra Plush Standard Finish: N/A

COL: 85 square feet

1	2	3	4	5	6	8	COL	S Nail	M Nail
3300	3435	3570	3705	3840	3975	5145	2217	N/A	N/A

L-6120-31

Paterson Swivel Chair

Wireless Charger

Width: 33.5 Depth: 34 Height: 37.5

AH: 27 SH: 21.5 SD: 21 IW: 23

Weight: 85 / 85 lbs Cube: 24.71

Standard Pillows: N/A Finish Required: N

Standard Cushions: Ultra Plush Standard Finish: N/A

COL: 102 square feet

Standard with leftside facing wireless charger for iPhone & Android Cellular Phones

1	2	3	4	5	6	8	COL	S Nail	M Nail
3555	3720	3885	4050	4215	4380	5790	2244	45	60

L-6120-32

Paterson Swivel Glider

Wireless Charger

Width: 33.5 Depth: 34 Height: 37.5

AH: 27 SH: 21.5 SD: 21 IW: 23

Weight: 85 / 85 lbs Cube: 24.71

Standard Pillows: N/A Finish Required: N

Standard Cushions: Ultra Plush Standard Finish: N/A

COL: 102 square feet

Standard with leftside facing wireless charger for iPhone & Android Cellular Phones

1	2	3	4	5	6	8	COL	S Nail	M Nail
3705	3870	4035	4200	4365	4530	5940	2394	45	60

LEATHER

L-6121-31

PELLE PROVISIONS
Paterson Swivel Chair

Standard Pillows: N/A Finish Required: N
Standard Cushions: Ultra Plush Standard Finish: N/A
COL: 113 square feet

Width: 33.5 Depth: 34 Height: 37.5
AH: 27 SH: 21.5 SD: 21 IW: 23
Weight: 75 / 85 lbs Cube: 29.69

1	2	3	4	5	6	8	COL	S Nail	M Nail
3465	3645	3825	4005	4185	4365	5925	2244	45	60

L-6122-31

Paterson Swivel Chair
UV-C Phone Charger with Sanitation

Standard Pillows: N/A Finish Required: N
Standard Cushions: Ultra Plush Standard Finish: N/A
COL: 102 square feet
Left Side Facing Ultraviolet Disinfecting & Charging unit for iPhone and Android cellular phones.

Width: 33.5 Depth: 34 Height: 37.5
AH: 27 SH: 21.5 SD: 21 IW: 23
Weight: 85 / 85 lbs Cube: 24.71

1	2	3	4	5	6	8	COL	S Nail	M Nail
3600	3765	3930	4095	4260	4425	5835	2244	45	60

L-6122-32

Paterson Swivel Glider
UV-C Phone Charger with Sanitation

Standard Pillows: N/A Finish Required: N
Standard Cushions: Ultra Plush Standard Finish: N/A
COL: 102 square feet
Left Side Facing Ultraviolet Disinfecting & Charging unit for iPhone and Android cellular phones.

Width: 33.5 Depth: 34 Height: 37.5
AH: 27 SH: 21.5 SD: 21 IW: 23
Weight: 85 / 85 lbs Cube: 24.71

1	2	3	4	5	6	8	COL	S Nail	M Nail
3750	3915	4080	4245	4410	4575	5985	2394	45	60

L-6196-01

PELLE PROVISIONS
Madison Lounge Chair

Standard Pillows: N/A Finish Required: Y
Standard Cushions: High Resiliency 30 Standard Finish: N/A
COL: 76.5 square feet

Width: 27 Depth: 30.5 Height: 34.5
AH: 24 SH: 19 SD: 19 IW: 20
Weight: 41 / 54 lbs Cube: 21.65

1	2	3	4	5	6	8	COL	S Nail	M Nail
3060	3180	3300	3420	3540	3660	4710	2070	120	N/A

L-6196-50

Madison Sofa
Leather

Standard Pillows: N/A Finish Required: Y
Standard Cushions: High Resiliency 30 Standard Finish: N/A
COL: 169 square feet

Width: 86.5 Depth: 30.5 Height: 34.5
AH: 24 SH: 19 SD: 19 IW: 79.5
Weight: 96 / 96 lbs Cube: 52.67

1	2	3	4	5	6	8	COL	S Nail	M Nail
4875	5130	5385	5640	5895	6150	8475	3177	270	N/A

L-6196-70

Madison Loveseat
Leather

Standard Pillows: N/A Finish Required: Y
Standard Cushions: High Resiliency 30 Standard Finish: N/A
COL: 124 square feet

Width: 59 Depth: 30.5 Height: 34.5
AH: 24 SH: 19 SD: 19 IW: 52
Weight: 75 / 75 lbs Cube: 35.92

1	2	3	4	5	6	8	COL	S Nail	M Nail
4050	4245	4440	4635	4830	5025	6735	2829	210	N/A

L-6197-01

PELLE PROVISIONS
Norwood Lounge Chair

Standard Pillows: N/A Finish Required: Y
Standard Cushions: High Resiliency 30 Standard Finish: N/A
COL: 85 square feet

Width: 26.5 Depth: 28 Height: 31.5
AH: 24 SH: 19 SD: 18.5 IW: 20.5
Weight: 35 / 49 lbs Cube: 21.65

1	2	3	4	5	6	8	COL	S Nail	M Nail
3225	3360	3495	3630	3765	3900	5070	2220	135	N/A

LEATHER

L-6197-50

Norwood Sofa
Leather

Width: 80 **Depth:** 28.25 **Height:** 31.5
AH: 25 **SH:** 18.75 **SD:** 19 **IW:** 74
Weight: 93 / 93 lbs **Cube:** 41.19

Standard Pillows: N/A **Finish Required:** Y
Standard Cushions: High Resiliency 30 **Standard Finish:** N/A
COL: 175 square feet

1 5085	2 5355	3 5625	4 5895	5 6165	6 6435	8 8850	COL 3366	S Nail 240	M Nail N/A
------------------	------------------	------------------	------------------	------------------	------------------	------------------	--------------------	----------------------	----------------------

L-6197-70

Norwood Loveseat
Leather

Width: 70 **Depth:** 28.25 **Height:** 31.5
AH: 25 **SH:** 18.75 **SD:** 19 **IW:** 64
Weight: 80 / 80 lbs **Cube:** 36.04

Standard Pillows: N/A **Finish Required:** Y
Standard Cushions: High Resiliency 30 **Standard Finish:** N/A
COL: 158 square feet

1 4785	2 5025	3 5265	4 5505	5 5745	6 5985	8 8160	COL 3117	S Nail 225	M Nail N/A
------------------	------------------	------------------	------------------	------------------	------------------	------------------	--------------------	----------------------	----------------------

L-6201-01-2

Rivoli Lounge Chair

Width: 32 **Depth:** 33 **Height:** 30.5
AH: 23 **SH:** 19 **SD:** 23 **IW:** 22
Weight: 39 / 45 lbs **Cube:** 18.63

Standard Pillows: N/A **Finish Required:** N
Standard Cushions: Ultra Plush **Standard Finish:** Nickel
COL: 85.85 square feet

1 3465	2 3600	3 3735	4 3870	5 4005	6 4140	8 5325	COL 2505	S Nail N/A	M Nail N/A
------------------	------------------	------------------	------------------	------------------	------------------	------------------	--------------------	----------------------	----------------------

L-6201-01-7

Rivoli Lounge Chair

Width: 32 **Depth:** 33 **Height:** 30.5
AH: 23 **SH:** 19 **SD:** 23 **IW:** 22
Weight: 39 / 53 lbs **Cube:** 18.63

Standard Pillows: N/A **Finish Required:** N
Standard Cushions: Ultra Plush **Standard Finish:** Bright Brass
COL: 85.85 square feet

1 3465	2 3600	3 3735	4 3870	5 4005	6 4140	8 5325	COL 2505	S Nail N/A	M Nail N/A
------------------	------------------	------------------	------------------	------------------	------------------	------------------	--------------------	----------------------	----------------------

L-6203-01-2

Capri Lounge Chair

Width: 31.5 **Depth:** 33 **Height:** 31
AH: 23 **SH:** 17.5 **SD:** 22 **IW:** 21.5
Weight: 47 / 60 lbs **Cube:** 18.64

Standard Pillows: N/A **Finish Required:** N
Standard Cushions: High Resiliency 40 **Standard Finish:** Nickel
COL: 90.95 square feet

1 3300	2 3435	3 3570	4 3705	5 3840	6 3975	8 5235	COL 2370	S Nail N/A	M Nail N/A
------------------	------------------	------------------	------------------	------------------	------------------	------------------	--------------------	----------------------	----------------------

L-6203-01-7

Capri Lounge Chair

Width: 31.5 **Depth:** 33 **Height:** 31
AH: 23 **SH:** 17.5 **SD:** 22 **IW:** 21.5
Weight: 47 / 61 lbs **Cube:** 18.64

Standard Pillows: N/A **Finish Required:** N
Standard Cushions: High Resiliency 40 **Standard Finish:** Bright Brass
COL: 90.95 square feet

1 3300	2 3435	3 3570	4 3705	5 3840	6 3975	8 5235	COL 2370	S Nail N/A	M Nail N/A
------------------	------------------	------------------	------------------	------------------	------------------	------------------	--------------------	----------------------	----------------------

L-6204-01-2

Verona Lounge Chair

Width: 30.5 **Depth:** 32.5 **Height:** 32
AH: 22 **SH:** 17.5 **SD:** 22 **IW:** 22.5
Weight: 47 / 61 lbs **Cube:** 18.35

Standard Pillows: N/A **Finish Required:** N
Standard Cushions: High Resiliency 40 **Standard Finish:** Nickel
COL: 81.6 square feet

1 3225	2 3345	3 3465	4 3585	5 3705	6 3825	8 4950	COL 2370	S Nail N/A	M Nail N/A
------------------	------------------	------------------	------------------	------------------	------------------	------------------	--------------------	----------------------	----------------------

LEATHER

L-6204-01-7

Verona Lounge Chair

Standard Pillows: N/A **Finish Required:** N
Standard Cushions: High Resiliency 40 **Standard Finish:** Bright Brass
COL: 81.6 square feet

Width: 30.5 **Depth:** 32.5 **Height:** 32
AH: 22 **SH:** 17.5 **SD:** 22 **IW:** 22.5
Weight: 47 / 60 lbs **Cube:** 18.35

1	2	3	4	5	6	8	COL	S Nail	M Nail
3225	3345	3465	3585	3705	3825	4950	2370	N/A	N/A

L-6205-01

Brixton Occasional Chair

Standard Pillows: N/A **Finish Required:** Y
Standard Cushions: High Resiliency 40 **Standard Finish:** N/A
COL: 63 square feet

Width: 28.5 **Depth:** 32 **Height:** 34.5
AH: 24.5 **SH:** 19 **SD:** 20 **IW:** 24
Weight: 30 / 44 lbs **Cube:** 18.2

1	2	3	4	5	6	8	COL	S Nail	M Nail
2745	2850	2955	3060	3165	3270	4140	1971	N/A	N/A

L-6302-50

LIBBY LANGDON FOR FAIRFIELD, PELLE PROVISIONS
Ryerson Sofa
 Bench Seat Cushion

Standard Pillows: N/A **Finish Required:** Y
Standard Cushions: Blendown **Standard Finish:** N/A
COL: 220 square feet
 Features bench seat cushion.

Width: 86.5 **Depth:** 38 **Height:** 30.5
AH: 24.5 **SH:** 20.5 **SD:** 23 **IW:** 76
Weight: 160 / 198 lbs **Cube:** 79.34

1	2	3	4	5	6	8	COL	S Nail	M Nail
7806	8136	8466	8796	9126	9456	12486	5421	N/A	N/A

L-6322-01

LIBBY LANGDON FOR FAIRFIELD, PELLE PROVISIONS
Alana Lounge Chair

Standard Pillows: N/A **Finish Required:** Y
Standard Cushions: High Resiliency 30 **Standard Finish:** N/A
COL: 90 square feet

Width: 29 **Depth:** 35.5 **Height:** 36
AH: 23.5 **SH:** 18 **SD:** 23 **IW:** 21.5
Weight: 38 / 38 lbs **Cube:** 21.44

1	2	3	4	5	6	8	COL	S Nail	M Nail
3075	3210	3345	3480	3615	3750	4995	2190	90	N/A

L-6324-C6

Boyd Counter Stool
 Leather

Standard Pillows: N/A **Finish Required:** Y
Standard Cushions: High Resiliency 40 **Standard Finish:** N/A
COL: 45 square feet

Width: 22 **Depth:** 24.5 **Height:** 39
AH: 34 **SH:** 27 **SD:** 20 **IW:** 22
Weight: 24 / 24 lbs **Cube:** 12.16

1	2	3	4	5	6	8	COL	S Nail	M Nail
2250	2325	2400	2475	2550	2625	3255	1722	N/A	N/A

L-6324-04

LIBBY LANGDON FOR FAIRFIELD, PELLE PROVISIONS
Boyd Dining Chair

Standard Pillows: N/A **Finish Required:** Y
Standard Cushions: High Resiliency 40 **Standard Finish:** N/A
COL: 45 square feet

Width: 22 **Depth:** 24.5 **Height:** 32
AH: - **SH:** 19 **SD:** 20 **IW:** 22
Weight: 19 / 19 lbs **Cube:** 9.98

1	2	3	4	5	6	8	COL	S Nail	M Nail
2130	2205	2280	2355	2430	2505	3135	1557	N/A	N/A

L-6324-06

Boyd Bar Stool
 Leather

Standard Pillows: N/A **Finish Required:** Y
Standard Cushions: High Resiliency 40 **Standard Finish:** N/A
COL: 45 square feet

Width: 22 **Depth:** 24.5 **Height:** 43
AH: 38 **SH:** 31 **SD:** 20 **IW:** 22
Weight: 25 / 25 lbs **Cube:** 13.41

1	2	3	4	5	6	8	COL	S Nail	M Nail
2250	2325	2400	2475	2550	2625	3255	1722	N/A	N/A

LEATHER

L-6405-01-6

LIBBY LANGDON FOR FAIRFIELD
Hinsdale Occasional Chair

Standard Pillows: N/A Finish Required: N

Standard Cushions: High Resilency 30 Standard Finish: BRUSHED BRASS
COL: 62 square feet

Width: 25.25 Depth: 29 Height: 34

AH: 23.5 SH: 20 SD: 21 IW: 20.25

Weight: 41 / 53 lbs Cube: 14.4

1	2	3	4	5	6	8	COL	S Nail	M Nail
3300	3405	3510	3615	3720	3825	4680	2502	N/A	N/A

L-6406-01

LIBBY LANGDON FOR FAIRFIELD
Southampton Occasional Chair

Standard Pillows: N/A Finish Required: Y

Standard Cushions: High Resilency 30 Standard Finish: N/A
COL: 62 square feet

Width: 26.5 Depth: 27 Height: 29.5

AH: 25.5 SH: 18.5 SD: 23 IW: 21

Weight: 32 / 42 lbs Cube: 12.21

1	2	3	4	5	6	8	COL	S Nail	M Nail
2805	2910	3015	3120	3225	3330	4185	1947	75	N/A

L-6410-01

LIBBY LANGDON FOR FAIRFIELD, PELLE PROVISIONS
McAlee Occasional Chair

Standard Pillows: N/A Finish Required: Y

Standard Cushions: High Resilency 30 Standard Finish: N/A
COL: 57 square feet

Width: 26.5 Depth: 27.25 Height: 32

AH: 27.5 SH: 19 SD: 21 IW: 25

Weight: 27 / 37 lbs Cube: 21.65

1	2	3	4	5	6	8	COL	S Nail	M Nail
2685	2775	2865	2955	3045	3135	3930	1797	60	N/A

L-6412-01

PELLE PROVISIONS
Maycroft Occasional Chair

Standard Pillows: N/A Finish Required: Y

Standard Cushions: High Resilency 30 Standard Finish: N/A
COL: 68 square feet

Width: 29 Depth: 27 Height: 33.5

AH: 24 SH: 18.5 SD: 19 IW: 22

Weight: 34 / 47 lbs Cube: 23.89

1	2	3	4	5	6	8	COL	S Nail	M Nail
3060	3165	3270	3375	3480	3585	4530	1872	75	90

L-6450-04

LIBBY LANGDON FOR FAIRFIELD
Watermill Arm Chair

Standard Pillows: N/A Finish Required: Y

Standard Cushions: High Resilency 30 Standard Finish: N/A
COL: 62 square feet

Width: 23.75 Depth: 28.5 Height: 39

AH: 24.5 SH: 19.5 SD: 19.5 IW: 20

Weight: 23 / 36 lbs Cube: 15.27

1	2	3	4	5	6	8	COL	S Nail	M Nail
2400	2505	2610	2715	2820	2925	3780	1722	45	60

L-6450-05

LIBBY LANGDON FOR FAIRFIELD
Watermill Side Chair

Standard Pillows: N/A Finish Required: Y

Standard Cushions: High Resilency 30 Standard Finish: N/A
COL: 57 square feet

Width: 23.75 Depth: 28.5 Height: 39

AH: 19.5 SH: 19.5 SD: 19.5 IW: 20

Weight: 22 / 36 lbs Cube: 15.27

1	2	3	4	5	6	8	COL	S Nail	M Nail
2370	2460	2550	2640	2730	2820	3615	1692	45	60

L-6451-04

LIBBY LANGDON FOR FAIRFIELD
Briarcroft Arm Chair

Standard Pillows: N/A Finish Required: Y

Standard Cushions: High Resilency 30 Standard Finish: N/A
COL: 68 square feet

Width: 22 Depth: 26.5 Height: 41.5

AH: 25.5 SH: 20 SD: 18 IW: 18

Weight: 26 / 37 lbs Cube: 21.65

1	2	3	4	5	6	8	COL	S Nail	M Nail
2850	2955	3060	3165	3270	3375	4320	2016	60	N/A

LEATHER

L-6451-05

LIBBY LANGDON FOR FAIRFIELD
Briarcroft Side Chair

Standard Pillows: N/A **Finish Required:** Y
Standard Cushions: High Resiliency 30 **Standard Finish:** N/A
COL: 68 square feet

Width: 22 **Depth:** 26.5 **Height:** 41.5
AH: - **SH:** 20 **SD:** 18 **IW:** 18
Weight: 26 / 36 lbs **Cube:** 14

1	2	3	4	5	6	8	COL	S Nail	M Nail
2820	2925	3030	3135	3240	3345	4290	1986	60	N/A

L-6452-04

LIBBY LANGDON FOR FAIRFIELD, PELLE PROVISIONS
Sayers Arm Chair

Standard Pillows: N/A **Finish Required:** N
Standard Cushions: High Resiliency 40 **Standard Finish:** Cerused Espresso
COL: 24.3 square feet
 Features natural cane accents that was handwoven using the peel of natural rattan. As with any natural product, nature's imperfections and hallmarks will be present in the cane materials. Cane is a handcrafted product dating back to the Ancient Egyptians.

Width: 23.5 **Depth:** 27 **Height:** 36.5
AH: 25 **SH:** 20 **SD:** 18.5 **IW:** 20.25
Weight: 24 / 37 lbs **Cube:** 21.65

1	2	3	4	5	6	8	COL	S Nail	M Nail
2070	2115	2160	2205	2250	2295	2640	1842	N/A	N/A

L-6469-01

PELLE PROVISIONS
Halsey Lounge Chair

Standard Pillows: N/A **Finish Required:** Y
Standard Cushions: Ultra Plush **Standard Finish:** N/A
COL: 130 square feet
 Chair version of the 469C-MR & 469C-PR Recliner.

Width: 25.5 **Depth:** 36.5 **Height:** 39.25
AH: 25.5 **SH:** 20 **SD:** 20 **IW:** 21
Weight: 73 / 70 lbs **Cube:** 29.69

1	2	3	4	5	6	8	COL	S Nail	M Nail
4350	4545	4740	4935	5130	5325	7110	2868	75	90

L-6469-20

LIBBY LANGDON FOR FAIRFIELD
Halsey Ottoman

Standard Pillows: N/A **Finish Required:** Y
Standard Cushions: High Resiliency 30 **Standard Finish:** N/A
COL: 45 square feet

Width: 22.25 **Depth:** 19.25 **Height:** 18.25
AH: - **SH:** - **SD:** - **IW:** -
Weight: 12 / 19 lbs **Cube:** 4.52

1	2	3	4	5	6	8	COL	S Nail	M Nail
1935	2010	2085	2160	2235	2310	2940	1197	30	45

L-6500-C7

LIBBY LANGDON FOR FAIRFIELD, PELLE PROVISIONS
Morrison Leather Counter Stool

Standard Pillows: N/A **Finish Required:** Y
Standard Cushions: High Resiliency 40 **Standard Finish:** N/A
COL: 40 square feet
 Standard with Nickel Footrest

Width: 21 **Depth:** 23 **Height:** 33
AH: - **SH:** 24.75 **SD:** 17 **IW:** 18.5
Weight: 22 / 22 lbs **Cube:** 9.22

1	2	3	4	5	6	8	COL	S Nail	M Nail
2055	2115	2175	2235	2295	2355	2910	1548	N/A	N/A

L-6600-10

LIBBY LANGDON FOR FAIRFIELD
Brookwood Bench

Standard Pillows: N/A **Finish Required:** Y
Standard Cushions: High Resiliency 30 **Standard Finish:** N/A
COL: 68 square feet

Width: 51.75 **Depth:** 15.5 **Height:** 21.25
AH: 21.25 **SH:** 20 **SD:** 15 **IW:** 50.5
Weight: 29 / 49 lbs **Cube:** 9.86

1	2	3	4	5	6	8	COL	S Nail	M Nail
2640	2745	2850	2955	3060	3165	4110	1866	N/A	N/A

L-6600-20

LIBBY LANGDON FOR FAIRFIELD
Brookwood Ottoman

Standard Pillows: N/A **Finish Required:** Y
Standard Cushions: High Resiliency 30 **Standard Finish:** N/A
COL: 51 square feet

Width: 22.75 **Depth:** 15.5 **Height:** 21.25
AH: 21.25 **SH:** 20 **SD:** 15 **IW:** 21.5
Weight: 14 / 23 lbs **Cube:** 4.33

1	2	3	4	5	6	8	COL	S Nail	M Nail
1815	1890	1965	2040	2115	2190	2895	1347	N/A	N/A

LEATHER

L-6602-20

LIBBY LANGDON FOR FAIRFIELD, PELLE PROVISIONS
Dryer Ottoman

Standard Pillows: N/A **Finish Required:** Y
Standard Cushions: High Resilency 30 **Standard Finish:** N/A
COL: 34.2 square feet

Width: 20.5 **Depth:** 20.5 **Height:** 20

AH: - **SH:** - **SD:** - **IW:** -

Weight: 23 / 30 lbs **Cube:** 4.86

1 1980	2 2040	3 2100	4 2160	5 2220	6 2280	8 2760	COL 1353	S Nail 30	M Nail N/A
------------------	------------------	------------------	------------------	------------------	------------------	------------------	--------------------	---------------------	----------------------

L-6602-36

LIBBY LANGDON FOR FAIRFIELD, PELLE PROVISIONS
Dryer Cocktail Ottoman

Standard Pillows: N/A **Finish Required:** Y
Standard Cushions: High Resilency 30 **Standard Finish:** N/A
COL: 63 square feet

Width: 36.5 **Depth:** 36.5 **Height:** 20

AH: - **SH:** - **SD:** - **IW:** -

Weight: 58 / 76 lbs **Cube:** 15.41

1 2640	2 2745	3 2850	4 2955	5 3060	6 3165	8 4035	COL 1875	S Nail 45	M Nail N/A
------------------	------------------	------------------	------------------	------------------	------------------	------------------	--------------------	---------------------	----------------------

L-6602-44

LIBBY LANGDON FOR FAIRFIELD, PELLE PROVISIONS
Dryer Cocktail Ottoman

Standard Pillows: N/A **Finish Required:** Y
Standard Cushions: High Resilency 30 **Standard Finish:** N/A
COL: 79 square feet

Width: 44.5 **Depth:** 44.5 **Height:** 20

AH: - **SH:** - **SD:** - **IW:** -

Weight: 84 / 104 lbs **Cube:** 29.69

1 3225	2 3345	3 3465	4 3585	5 3705	6 3825	8 4920	COL 2154	S Nail 60	M Nail N/A
------------------	------------------	------------------	------------------	------------------	------------------	------------------	--------------------	---------------------	----------------------

L-6602-52

LIBBY LANGDON FOR FAIRFIELD, PELLE PROVISIONS
Dryer Cocktail Ottoman

Standard Pillows: N/A **Finish Required:** Y
Standard Cushions: High Resilency 30 **Standard Finish:** N/A
COL: 72 square feet

Width: 52.5 **Depth:** 30.5 **Height:** 20

AH: - **SH:** - **SD:** - **IW:** -

Weight: 72 / 96 lbs **Cube:** 18.53

1 3030	2 3150	3 3270	4 3390	5 3510	6 3630	8 4620	COL 2220	S Nail 60	M Nail N/A
------------------	------------------	------------------	------------------	------------------	------------------	------------------	--------------------	---------------------	----------------------

L-6603-20

LIBBY LANGDON FOR FAIRFIELD, PELLE PROVISIONS
Edgemere Cocktail Ottoman

Standard Pillows: N/A **Finish Required:** Y
Standard Cushions: High Resilency 40 **Standard Finish:** N/A
COL: 45 square feet
 Features a biscuit tufted top and Brushed Brass ferrules

Width: 53 **Depth:** 31 **Height:** 18

AH: - **SH:** - **SD:** - **IW:** -

Weight: 78 / 102 lbs **Cube:** 17.11

1 2685	2 2760	3 2835	4 2910	5 2985	6 3060	8 3690	COL 2106	S Nail 45	M Nail N/A
------------------	------------------	------------------	------------------	------------------	------------------	------------------	--------------------	---------------------	----------------------

L-6612-20

LIBBY LANGDON FOR FAIRFIELD
Dryer Ottoman

Standard Pillows: N/A **Finish Required:** N
Standard Cushions: N/A **Standard Finish:** N/A
COL: 34.2 square feet

Width: 0 **Depth:** 0 **Height:** 0

AH: - **SH:** - **SD:** - **IW:** -

Weight: 0 / 0 lbs **Cube:** 0

1 2085	2 2145	3 2205	4 2265	5 2325	6 2385	8 2865	COL 1353	S Nail 30	M Nail N/A
------------------	------------------	------------------	------------------	------------------	------------------	------------------	--------------------	---------------------	----------------------

L-6651-10-6

LIBBY LANGDON FOR FAIRFIELD
Laurel Bench

Standard Pillows: N/A **Finish Required:** N
Standard Cushions: High Resilency 30 **Standard Finish:** BRUSHED BRASS
COL: 34.2 square feet

Width: 47 **Depth:** 19.5 **Height:** 22

AH: - **SH:** - **SD:** - **IW:** -

Weight: 36 / 56 lbs **Cube:** 11.66

1 2010	2 2070	3 2130	4 2190	5 2250	6 2310	8 2790	COL 1632	S Nail N/A	M Nail N/A
------------------	------------------	------------------	------------------	------------------	------------------	------------------	--------------------	----------------------	----------------------

LEATHER

L-6652-10

LIBBY LANGDON FOR FAIRFIELD
Carrington Bench

Width: 48 Depth: 16 Height: 19
AH: - SH: - SD: - IW: -
Weight: 38 / 52 lbs Cube: 8.44

Standard Pillows: N/A Finish Required: N
Standard Cushions: High Resiliency 40 Standard Finish: Sheer Dove
COL: 34.2 square feet
Features a polished nickel frame and a wooden magazine rack finished in Sheer Dove.

1	2	3	4	5	6	8	COL	S Nail	M Nail
2475	2535	2595	2655	2715	2775	3255	2118	N/A	N/A

L-6653-10-6

LIBBY LANGDON FOR FAIRFIELD
Laurel Ottoman

Width: 62.75 Depth: 18.5 Height: 22
AH: - SH: - SD: - IW: -
Weight: 33 / 62 lbs Cube: 14.77

Standard Pillows: N/A Finish Required: N
Standard Cushions: High Resiliency 40 Standard Finish: BRUSHED BRASS
COL: 45 square feet

1	2	3	4	5	6	8	COL	S Nail	M Nail
2280	2355	2430	2505	2580	2655	3285	1707	N/A	N/A

L-6765-C7-2

LIBBY LANGDON FOR FAIRFIELD
Jessup Counter Stool

Width: 19 Depth: 19 Height: 26.25
AH: - SH: 26.25 SD: 19 IW: 19
Weight: 20 / 30 lbs Cube: 5.48

Standard Pillows: N/A Finish Required: N
Standard Cushions: High Resiliency 40 Standard Finish: Nickel
COL: 34.2 square feet

1	2	3	4	5	6	8	COL	S Nail	M Nail
1980	2040	2100	2160	2220	2280	2760	1569	N/A	N/A

L-7401-01

PELLE PROVISIONS
Capelli Wing Chair

Width: 34.25 Depth: 33.5 Height: 47.5
AH: 25.5 SH: 22.5 SD: 20 IW: 21
Weight: 50 / 50 lbs Cube: 31.53

Standard Pillows: N/A Finish Required: Y
Standard Cushions: Classic Plush Standard Finish: N/A
COL: 119 square feet

1	2	3	4	5	6	8	COL	S Nail	M Nail
4125	4305	4485	4665	4845	5025	6660	2853	Std.	N/A

L-8060-01

Kirkland Occasional Chair

Width: 28 Depth: 31.5 Height: 38.5
AH: 25.5 SH: 20 SD: 23 IW: 23
Weight: 30 / 40 lbs Cube: 19.65

Standard Pillows: N/A Finish Required: Y
Standard Cushions: High Resiliency 40 Standard Finish: N/A
COL: 43.2 square feet

1	2	3	4	5	6	8	COL	S Nail	M Nail
2040	2115	2190	2265	2340	2415	3015	1482	45	60

L-8207-MR

Layla Motion Rocker

Width: 25 Depth: 25.5 Height: 44
AH: 25.5 SH: 19 SD: 17.5 IW: 20
Weight: 55 / 68 lbs Cube: 16.23

Standard Pillows: N/A Finish Required: Y
Standard Cushions: High Resiliency 40 Standard Finish: N/A
COL: 45.9 square feet

1	2	3	4	5	6	8	COL	S Nail	M Nail
2220	2295	2370	2445	2520	2595	3225	1752	N/A	N/A

L-8227-MR

Bella Motion Rocker

Width: 23 Depth: 25.5 Height: 44
AH: 25.5 SH: 19 SD: 17.5 IW: 20
Weight: 55 / 77 lbs Cube: 14.93

Standard Pillows: N/A Finish Required: Y
Standard Cushions: High Resiliency 40 Standard Finish: N/A
COL: 54 square feet

1	2	3	4	5	6	8	COL	S Nail	M Nail
2370	2460	2550	2640	2730	2820	3570	1752	N/A	N/A

LEATHER

L-8228-MR

Bella Motion Rocker

Standard Pillows: N/A **Finish Required:** Y
Standard Cushions: High Resiliency 40 **Standard Finish:** N/A
COL: 70 square feet

Width: 23 **Depth:** 25.5 **Height:** 44
AH: 25.5 **SH:** 19 **SD:** 17.5 **IW:** 20
Weight: 55 / 68 lbs **Cube:** 14.93

1 2805	2 2910	3 3015	4 3120	5 3225	6 3330	8 4290	COL 1752	S Nail N/A	M Nail N/A
------------------	------------------	------------------	------------------	------------------	------------------	------------------	--------------------	----------------------	----------------------

L-8250-A4

Phillips Occasional Chair

Standard Pillows: N/A **Finish Required:** Y
Standard Cushions: High Resiliency 40 **Standard Finish:** N/A
COL: 51 square feet

Width: 23.5 **Depth:** 26.5 **Height:** 38.5
AH: 26 **SH:** 18.5 **SD:** 19 **IW:** 18
Weight: 35 / 40 lbs **Cube:** 13.87

1 2070	2 2145	3 2220	4 2295	5 2370	6 2445	8 3150	COL 1386	S Nail Std.	M Nail 15
------------------	------------------	------------------	------------------	------------------	------------------	------------------	--------------------	-----------------------	---------------------

L-8250-01

Phillips Occasional Chair

Standard Pillows: N/A **Finish Required:** Y
Standard Cushions: High Resiliency 40 **Standard Finish:** N/A
COL: 51 square feet

Width: 24.5 **Depth:** 26.5 **Height:** 38.5
AH: 26 **SH:** 18.5 **SD:** 19 **IW:** 18
Weight: 30 / 35 lbs **Cube:** 14.46

1 1980	2 2055	3 2130	4 2205	5 2280	6 2355	8 3060	COL 1386	S Nail Std.	M Nail 15
------------------	------------------	------------------	------------------	------------------	------------------	------------------	--------------------	-----------------------	---------------------

L-8321-01

Putnam Side Chair

Standard Pillows: N/A **Finish Required:** Y
Standard Cushions: High Resiliency 40 **Standard Finish:** N/A
COL: 51 square feet

Width: 22 **Depth:** 24.5 **Height:** 35.5
AH: - **SH:** 19.5 **SD:** 18.5 **IW:** 22
Weight: 25 / 35 lbs **Cube:** 11.07

1 2070	2 2145	3 2220	4 2295	5 2370	6 2445	8 3150	COL 1422	S Nail N/A	M Nail N/A
------------------	------------------	------------------	------------------	------------------	------------------	------------------	--------------------	----------------------	----------------------

L-8322-01

Burton Occasional Chair

Standard Pillows: N/A **Finish Required:** Y
Standard Cushions: High Resiliency 40 **Standard Finish:** N/A
COL: 34.2 square feet

Width: 25.5 **Depth:** 25.5 **Height:** 33
AH: 26 **SH:** 20.5 **SD:** 20 **IW:** 20.5
Weight: 26 / 36 lbs **Cube:** 12.41

1 1845	2 1905	3 1965	4 2025	5 2085	6 2145	8 2625	COL 1443	S Nail Std.	M Nail N/A
------------------	------------------	------------------	------------------	------------------	------------------	------------------	--------------------	-----------------------	----------------------

L-8326-05

Portsmouth Side Chair

Standard Pillows: N/A **Finish Required:** Y
Standard Cushions: High Resiliency 40 **Standard Finish:** N/A
COL: 19.8 square feet

Width: 20 **Depth:** 23 **Height:** 38
AH: - **SH:** 19.5 **SD:** 19 **IW:** -
Weight: 20 / 30 lbs **Cube:** 10.11

1 1350	2 1380	3 1410	4 1440	5 1470	6 1500	8 1770	COL 1128	S Nail 45	M Nail 60
------------------	------------------	------------------	------------------	------------------	------------------	------------------	--------------------	---------------------	---------------------

L-8329-C7

Ardmore Counter Stool

Standard Pillows: N/A **Finish Required:** Y
Standard Cushions: High Resiliency 30 **Standard Finish:** N/A
COL: 45 square feet

Width: 20 **Depth:** 22.5 **Height:** 42
AH: - **SH:** 26.5 **SD:** 17.5 **IW:** -
Weight: 35 / 40 lbs **Cube:** 10.93

1 1980	2 2055	3 2130	4 2205	5 2280	6 2355	8 2985	COL 1377	S Nail 45	M Nail 60
------------------	------------------	------------------	------------------	------------------	------------------	------------------	--------------------	---------------------	---------------------

LEATHER

L-8329-01

Ardmore Side Chair

Standard Pillows: N/A **Finish Required:** Y
Standard Cushions: High Resilency 30 **Standard Finish:** N/A
COL: 45 square feet

Width: 21 **Depth:** 24.5 **Height:** 36.5
AH: - **SH:** 21.5 **SD:** 21 **IW:** 21
Weight: 25 / 30 lbs **Cube:** 10.86

1	2	3	4	5	6	8	COL	S Nail	M Nail
1890	1965	2040	2115	2190	2265	2895	1332	45	60

L-8329-07

Ardmore Bar Stool

Standard Pillows: N/A **Finish Required:** Y
Standard Cushions: High Resilency 30 **Standard Finish:** N/A
COL: 45 square feet

Width: 20 **Depth:** 22.5 **Height:** 45.5
AH: - **SH:** 30 **SD:** 17.5 **IW:** -
Weight: 35 / 40 lbs **Cube:** 11.84

1	2	3	4	5	6	8	COL	S Nail	M Nail
1980	2055	2130	2205	2280	2355	2985	1377	45	60

L-8337-01

Pierce Occasional Chair

Standard Pillows: N/A **Finish Required:** Y
Standard Cushions: Ultra Plush **Standard Finish:** N/A
COL: 67.5 square feet

Width: 26 **Depth:** 26.5 **Height:** 34
AH: 24 **SH:** 20.5 **SD:** 20.5 **IW:** 20
Weight: 35 / 40 lbs **Cube:** 13.55

1	2	3	4	5	6	8	COL	S Nail	M Nail
2775	2880	2985	3090	3195	3300	4230	1971	45	N/A

L-8339-04

Brookfield Arm Chair

Standard Pillows: N/A **Finish Required:** Y
Standard Cushions: High Resilency 40 **Standard Finish:** N/A
COL: 34 square feet

Width: 24.5 **Depth:** 25 **Height:** 39
AH: 28 **SH:** 19.5 **SD:** 18 **IW:** 21
Weight: 30 / 35 lbs **Cube:** 13.82

1	2	3	4	5	6	8	COL	S Nail	M Nail
1845	1905	1965	2025	2085	2145	2610	1533	N/A	N/A

L-8363-A2

Hamlin Arm Chair

Standard Pillows: N/A **Finish Required:** Y
Standard Cushions: High Resilency 40 **Standard Finish:** N/A
COL: 34.2 square feet

Width: 24.5 **Depth:** 24 **Height:** 38
AH: 24.5 **SH:** 20 **SD:** 18.5 **IW:** 20.5
Weight: 30 / 35 lbs **Cube:** 12.93

1	2	3	4	5	6	8	COL	S Nail	M Nail
1710	1770	1830	1890	1950	2010	2490	1284	45	60

L-8363-A4

Hamlin Arm Chair

Standard Pillows: N/A **Finish Required:** Y
Standard Cushions: High Resilency 40 **Standard Finish:** N/A
COL: 34.2 square feet

Width: 24.5 **Depth:** 24 **Height:** 38
AH: 24.5 **SH:** 20 **SD:** 18.5 **IW:** 20.5
Weight: 30 / 35 lbs **Cube:** 12.93

1	2	3	4	5	6	8	COL	S Nail	M Nail
1770	1830	1890	1950	2010	2070	2550	1284	45	60

L-8363-04

Hamlin Arm Chair

Standard Pillows: N/A **Finish Required:** Y
Standard Cushions: High Resilency 40 **Standard Finish:** N/A
COL: 40 square feet

Width: 24.5 **Depth:** 23 **Height:** 38
AH: 24.5 **SH:** 20 **SD:** 17.5 **IW:** 20.5
Weight: 30 / 35 lbs **Cube:** 12.39

1	2	3	4	5	6	8	COL	S Nail	M Nail
1680	1740	1800	1860	1920	1980	2535	1284	45	60

LEATHER

L-8363-05

Standard Pillows: N/A **Finish Required:** Y
Standard Cushions: High Resiliency 40 **Standard Finish:** N/A
COL: 34.2 square feet

Hamlin Side Chair

Width: 21.5 **Depth:** 23 **Height:** 37
AH: - **SH:** 19.5 **SD:** 18 **IW:** 21.5
Weight: 25 / 35 lbs **Cube:** 10.58

1 1632	2 1692	3 1752	4 1812	5 1872	6 1932	8 2412	COL 1284	S Nail 45	M Nail N/A
------------------	------------------	------------------	------------------	------------------	------------------	------------------	--------------------	---------------------	----------------------

L-8365-A2

Standard Pillows: N/A **Finish Required:** Y
Standard Cushions: High Resiliency 40 **Standard Finish:** N/A
COL: 34 square feet

Jefferson Arm Chair

Width: 24.5 **Depth:** 23 **Height:** 38
AH: 24.5 **SH:** 20 **SD:** 17.5 **IW:** 20.5
Weight: 25 / 30 lbs **Cube:** 12.39

1 1755	2 1815	3 1875	4 1935	5 1995	6 2055	8 2520	COL 1284	S Nail 45	M Nail 60
------------------	------------------	------------------	------------------	------------------	------------------	------------------	--------------------	---------------------	---------------------

L-8365-A4

Standard Pillows: N/A **Finish Required:** Y
Standard Cushions: High Resiliency 40 **Standard Finish:** N/A
COL: 34 square feet

Jefferson Arm Chair

Width: 24.5 **Depth:** 23 **Height:** 38
AH: 24.5 **SH:** 20 **SD:** 17.5 **IW:** 20.5
Weight: 25 / 30 lbs **Cube:** 12.39

1 1800	2 1860	3 1920	4 1980	5 2040	6 2100	8 2565	COL 1284	S Nail 45	M Nail 60
------------------	------------------	------------------	------------------	------------------	------------------	------------------	--------------------	---------------------	---------------------

L-8368-A2

Standard Pillows: N/A **Finish Required:** Y
Standard Cushions: High Resiliency 40 **Standard Finish:** N/A
COL: 40 square feet

Bayfield Arm Chair

Width: 24.5 **Depth:** 27 **Height:** 40
AH: 26.5 **SH:** 20 **SD:** 19 **IW:** 21
Weight: 35 / 40 lbs **Cube:** 15.31

1 1785	2 1845	3 1905	4 1965	5 2025	6 2085	8 2640	COL 1338	S Nail N/A	M Nail N/A
------------------	------------------	------------------	------------------	------------------	------------------	------------------	--------------------	----------------------	----------------------

L-8368-A4

Standard Pillows: N/A **Finish Required:** Y
Standard Cushions: High Resiliency 40 **Standard Finish:** N/A
COL: 40 square feet

Bayfield Arm Chair

Width: 24.5 **Depth:** 27 **Height:** 40
AH: 26.5 **SH:** 20 **SD:** 19 **IW:** 21
Weight: 35 / 40 lbs **Cube:** 15.31

1 1830	2 1890	3 1950	4 2010	5 2070	6 2130	8 2685	COL 1338	S Nail N/A	M Nail N/A
------------------	------------------	------------------	------------------	------------------	------------------	------------------	--------------------	----------------------	----------------------

L-8368-04

Standard Pillows: N/A **Finish Required:** Y
Standard Cushions: High Resiliency 40 **Standard Finish:** N/A
COL: 40 square feet

Bayfield Arm Chair

Width: 24.5 **Depth:** 27 **Height:** 40
AH: 26.5 **SH:** 20 **SD:** 19 **IW:** 21
Weight: 35 / 40 lbs **Cube:** 15.31

1 1755	2 1815	3 1875	4 1935	5 1995	6 2055	8 2610	COL 1338	S Nail N/A	M Nail N/A
------------------	------------------	------------------	------------------	------------------	------------------	------------------	--------------------	----------------------	----------------------

L-8378-A2

Standard Pillows: N/A **Finish Required:** Y
Standard Cushions: High Resiliency 40 **Standard Finish:** N/A
COL: 34 square feet

Mackay Arm Chair

Width: 22 **Depth:** 24 **Height:** 36
AH: 26 **SH:** 19 **SD:** 17.5 **IW:** 19
Weight: 22 / 33 lbs **Cube:** 11

1 1710	2 1770	3 1830	4 1890	5 1950	6 2010	8 2475	COL 1248	S Nail N/A	M Nail N/A
------------------	------------------	------------------	------------------	------------------	------------------	------------------	--------------------	----------------------	----------------------

LEATHER

L-8378-04

Mackay Arm Chair

Standard Pillows: N/A **Finish Required:** Y
Standard Cushions: High Resilency 40 **Standard Finish:** N/A
COL: 40 square feet

Width: 22 **Depth:** 24 **Height:** 36
AH: 26 **SH:** 19 **SD:** 17.5 **IW:** 19
Weight: 30 / 40 lbs **Cube:** 11

1 1695	2 1755	3 1815	4 1875	5 1935	6 1995	8 2550	COL 1248	S Nail N/A	M Nail N/A
------------------	------------------	------------------	------------------	------------------	------------------	------------------	--------------------	----------------------	----------------------

L-8379-01

PELLE PROVISIONS

Ashton Occasional Chair

Standard Pillows: N/A **Finish Required:** Y
Standard Cushions: High Resilency 40 **Standard Finish:** N/A
COL: 62 square feet

Width: 25.5 **Depth:** 29.5 **Height:** 38
AH: 23 **SH:** 19.5 **SD:** 19 **IW:** 18
Weight: 35 / 45 lbs **Cube:** 21.09

1 2310	2 2415	3 2520	4 2625	5 2730	6 2835	8 3690	COL 1722	S Nail 60	M Nail 75
------------------	------------------	------------------	------------------	------------------	------------------	------------------	--------------------	---------------------	---------------------

L-8379-1N

Ashton Task Chair

Standard Pillows: N/A **Finish Required:** N
Standard Cushions: High Resilency 40 **Standard Finish:** N/A
COL: 62 square feet
 Features Swivel Nickel Base with Casters

Width: 25 **Depth:** 27.75 **Height:** 39.75
AH: 21.5 **SH:** 20.75 **SD:** 18.75 **IW:** 18
Weight: 38 / 52 lbs **Cube:** 15.95

1 2625	2 2730	3 2835	4 2940	5 3045	6 3150	8 4005	COL 1971	S Nail 60	M Nail 75
------------------	------------------	------------------	------------------	------------------	------------------	------------------	--------------------	---------------------	---------------------

L-8379-2N

Ashton Swivel Chair

Standard Pillows: N/A **Finish Required:** N
Standard Cushions: High Resilency 40 **Standard Finish:** N/A
COL: 62 square feet
 Features Stationary Nickel Plated Base with a gas cylinder.

Width: 25 **Depth:** 27.75 **Height:** 38.25
AH: 20 **SH:** 19.25 **SD:** 18.75 **IW:** 18
Weight: 38 / 51 lbs **Cube:** 15.35

1 2625	2 2730	3 2835	4 2940	5 3045	6 3150	8 4005	COL 1971	S Nail 60	M Nail 75
------------------	------------------	------------------	------------------	------------------	------------------	------------------	--------------------	---------------------	---------------------

L-8379-35

PELLE PROVISIONS

Ashton Office Swivel Chair

Standard Pillows: N/A **Finish Required:** Y
Standard Cushions: High Resilency 40 **Standard Finish:** N/A
COL: 62 square feet
 Standard with a gas lift.

Width: 25.5 **Depth:** 29.5 **Height:** 33
AH: - **SH:** - **SD:** 19 **IW:** 18
Weight: 55 / 65 lbs **Cube:** 19.01

1 2640	2 2745	3 2850	4 2955	5 3060	6 3165	8 4020	COL 1971	S Nail 60	M Nail 75
------------------	------------------	------------------	------------------	------------------	------------------	------------------	--------------------	---------------------	---------------------

L-8389-01

Clancy Occasional Chair

Standard Pillows: N/A **Finish Required:** Y
Standard Cushions: High Resilency 40 **Standard Finish:** N/A
COL: 68 square feet

Width: 25.5 **Depth:** 29.5 **Height:** 38
AH: 23 **SH:** 19.5 **SD:** 19 **IW:** 18
Weight: 35 / 45 lbs **Cube:** 16.54

1 2505	2 2610	3 2715	4 2820	5 2925	6 3030	8 3975	COL 1722	S Nail 60	M Nail 75
------------------	------------------	------------------	------------------	------------------	------------------	------------------	--------------------	---------------------	---------------------

L-8389-35

Clancy Office Swivel Chair

Standard Pillows: N/A **Finish Required:** Y
Standard Cushions: High Resilency 40 **Standard Finish:** N/A
COL: 68 square feet
 Standard with a gas lift.

Width: 25.5 **Depth:** 29.5 **Height:** 33
AH: - **SH:** - **SD:** 19 **IW:** 18
Weight: 55 / 65 lbs **Cube:** 14.36

1 2745	2 2850	3 2955	4 3060	5 3165	6 3270	8 4215	COL 1971	S Nail 60	M Nail 75
------------------	------------------	------------------	------------------	------------------	------------------	------------------	--------------------	---------------------	---------------------

LEATHER

L-8403-A2

Avilla Arm Chair

Standard Pillows: N/A **Finish Required:** Y
Standard Cushions: High Resiliency 40 **Standard Finish:** N/A
COL: 53.1 square feet

Width: 25 **Depth:** 26 **Height:** 39.5
AH: 23.5 **SH:** 20.5 **SD:** 18.5 **IW:** 17
Weight: 30 / 35 lbs **Cube:** 14.85

1	2	3	4	5	6	8	COL	S Nail	M Nail
2325	2415	2505	2595	2685	2775	3510	1572	N/A	N/A

L-8403-04

Avilla Arm Chair

Standard Pillows: N/A **Finish Required:** Y
Standard Cushions: High Resiliency 40 **Standard Finish:** N/A
COL: 53.1 square feet

Width: 25 **Depth:** 26 **Height:** 39.5
AH: 23.5 **SH:** 20.5 **SD:** 18.5 **IW:** 17
Weight: 30 / 35 lbs **Cube:** 14.85

1	2	3	4	5	6	8	COL	S Nail	M Nail
2295	2385	2475	2565	2655	2745	3480	1572	N/A	N/A

L-8411-A2

Plymouth Arm Chair

Standard Pillows: N/A **Finish Required:** Y
Standard Cushions: High Resiliency 40 **Standard Finish:** N/A
COL: 34.2 square feet

Width: 23 **Depth:** 23 **Height:** 36.5
AH: 26 **SH:** 19.5 **SD:** 17.5 **IW:** 19
Weight: 30 / 35 lbs **Cube:** 11.17

1	2	3	4	5	6	8	COL	S Nail	M Nail
1710	1770	1830	1890	1950	2010	2490	1278	45	60

L-8411-A4

Plymouth Arm Chair

Standard Pillows: N/A **Finish Required:** Y
Standard Cushions: High Resiliency 40 **Standard Finish:** N/A
COL: 34.2 square feet

Width: 23 **Depth:** 23 **Height:** 36.5
AH: 26 **SH:** 19.5 **SD:** 17.5 **IW:** 19
Weight: 30 / 35 lbs **Cube:** 11.17

1	2	3	4	5	6	8	COL	S Nail	M Nail
1755	1815	1875	1935	1995	2055	2535	1278	45	60

L-8411-BC

Plymouth Bariatric Chair

Standard Pillows: N/A **Finish Required:** Y
Standard Cushions: High Resiliency 40 **Standard Finish:** N/A
COL: 51 square feet
 BIFMA tested up to 500 lbs. (static/dynamic)

Width: 35 **Depth:** 22 **Height:** 37
AH: 25.5 **SH:** 19 **SD:** 16.5 **IW:** 30.5
Weight: 40 / 59 lbs **Cube:** 16.48

1	2	3	4	5	6	8	COL	S Nail	M Nail
2160	2235	2310	2385	2460	2535	3240	1572	45	60

L-8411-04

Plymouth Arm Chair

Standard Pillows: N/A **Finish Required:** Y
Standard Cushions: High Resiliency 40 **Standard Finish:** N/A
COL: 34 square feet

Width: 23 **Depth:** 23 **Height:** 36.5
AH: 26 **SH:** 19.5 **SD:** 17.5 **IW:** 19
Weight: 30 / 35 lbs **Cube:** 11.17

1	2	3	4	5	6	8	COL	S Nail	M Nail
1680	1740	1800	1860	1920	1980	2445	1278	45	N/A

L-8444-A2

Selby Arm Chair

Standard Pillows: N/A **Finish Required:** Y
Standard Cushions: High Resiliency 40 **Standard Finish:** N/A
COL: 34.2 square feet

Width: 24.5 **Depth:** 26.5 **Height:** 38.5
AH: 25 **SH:** 18.5 **SD:** 18.5 **IW:** 19.5
Weight: 30 / 35 lbs **Cube:** 14.46

1	2	3	4	5	6	8	COL	S Nail	M Nail
1770	1830	1890	1950	2010	2070	2550	1290	N/A	N/A

LEATHER

L-8444-A4

Selby Arm Chair

Standard Pillows: N/A **Finish Required:** Y
Standard Cushions: High Resiliency 40 **Standard Finish:** N/A
COL: 34.2 square feet

Width: 24.5 **Depth:** 26.5 **Height:** 38.5
AH: 25 **SH:** 18.5 **SD:** 18.5 **IW:** 19.5
Weight: 31 / 41 lbs **Cube:** 14.46

1 1815	2 1875	3 1935	4 1995	5 2055	6 2115	8 2595	COL 1290	S Nail N/A	M Nail N/A
-----------	-----------	-----------	-----------	-----------	-----------	-----------	-------------	---------------	---------------

L-8444-04

Selby Arm Chair

Standard Pillows: N/A **Finish Required:** Y
Standard Cushions: High Resiliency 40 **Standard Finish:** N/A
COL: 40 square feet

Width: 24.5 **Depth:** 26.5 **Height:** 38.5
AH: 25 **SH:** 18.5 **SD:** 18.5 **IW:** 19.5
Weight: 30 / 35 lbs **Cube:** 14.46

1 1740	2 1800	3 1860	4 1920	5 1980	6 2040	8 2595	COL 1290	S Nail N/A	M Nail N/A
-----------	-----------	-----------	-----------	-----------	-----------	-----------	-------------	---------------	---------------

L-8484-A2

Powell Arm Chair

Standard Pillows: N/A **Finish Required:** Y
Standard Cushions: High Resiliency 40 **Standard Finish:** N/A
COL: 45 square feet

Width: 23 **Depth:** 25 **Height:** 38
AH: 26 **SH:** 20 **SD:** 19.5 **IW:** 19.5
Weight: 35 / 40 lbs **Cube:** 12.64

1 1815	2 1890	3 1965	4 2040	5 2115	6 2190	8 2820	COL 1368	S Nail 45	M Nail 60
-----------	-----------	-----------	-----------	-----------	-----------	-----------	-------------	--------------	--------------

L-8484-A4

Powell Arm Chair

Standard Pillows: N/A **Finish Required:** Y
Standard Cushions: High Resiliency 40 **Standard Finish:** N/A
COL: 45 square feet

Width: 23 **Depth:** 25 **Height:** 38
AH: 26 **SH:** 20 **SD:** 19.5 **IW:** 19.5
Weight: 35 / 40 lbs **Cube:** 12.64

1 1860	2 1935	3 2010	4 2085	5 2160	6 2235	8 2865	COL 1368	S Nail 45	M Nail 60
-----------	-----------	-----------	-----------	-----------	-----------	-----------	-------------	--------------	--------------

L-8484-04

Powell Arm Chair

Standard Pillows: N/A **Finish Required:** Y
Standard Cushions: High Resiliency 40 **Standard Finish:** N/A
COL: 45 square feet

Width: 23 **Depth:** 25 **Height:** 38
AH: 26 **SH:** 20 **SD:** 19.5 **IW:** 19.5
Weight: 35 / 40 lbs **Cube:** 12.64

1 1785	2 1860	3 1935	4 2010	5 2085	6 2160	8 2790	COL 1368	S Nail 45	M Nail 60
-----------	-----------	-----------	-----------	-----------	-----------	-----------	-------------	--------------	--------------

L-8484-05

Powell Side Chair

Standard Pillows: N/A **Finish Required:** Y
Standard Cushions: High Resiliency 40 **Standard Finish:** N/A
COL: 34.2 square feet

Width: 23 **Depth:** 24 **Height:** 37.5
AH: - **SH:** 19.5 **SD:** 19.5 **IW:** 23.5
Weight: 30 / 35 lbs **Cube:** 11.97

1 1755	2 1815	3 1875	4 1935	5 1995	6 2055	8 2535	COL 1335	S Nail 45	M Nail N/A
-----------	-----------	-----------	-----------	-----------	-----------	-----------	-------------	--------------	---------------

L-8486-A2

Seward Arm Chair

Standard Pillows: N/A **Finish Required:** Y
Standard Cushions: High Resiliency 40 **Standard Finish:** N/A
COL: 40 square feet

Width: 23 **Depth:** 24.5 **Height:** 38
AH: 26.5 **SH:** 20.5 **SD:** 19 **IW:** 20
Weight: 30 / 35 lbs **Cube:** 12.39

1 1797	2 1857	3 1917	4 1977	5 2037	6 2097	8 2652	COL 1368	S Nail 45	M Nail 60
-----------	-----------	-----------	-----------	-----------	-----------	-----------	-------------	--------------	--------------

LEATHER

L-8486-A4

Standard Pillows: N/A **Finish Required:** Y
Standard Cushions: High Resilency 40 **Standard Finish:** N/A
COL: 40 square feet

Seward Arm Chair

Width: 23 **Depth:** 24.5 **Height:** 38
AH: 26.5 **SH:** 20.5 **SD:** 19 **IW:** 20
Weight: 30 / 35 lbs **Cube:** 12.39

1 1845	2 1905	3 1965	4 2025	5 2085	6 2145	8 2700	COL 1368	S Nail 45	M Nail 60
------------------	------------------	------------------	------------------	------------------	------------------	------------------	--------------------	---------------------	---------------------

L-8486-04

Standard Pillows: N/A **Finish Required:** Y
Standard Cushions: High Resilency 40 **Standard Finish:** N/A
COL: 40 square feet

Seward Arm Chair

Width: 23 **Depth:** 24.5 **Height:** 38
AH: 26.5 **SH:** 20.5 **SD:** 19 **IW:** 20
Weight: 30 / 35 lbs **Cube:** 12.39

1 1770	2 1830	3 1890	4 1950	5 2010	6 2070	8 2625	COL 1368	S Nail 45	M Nail 60
------------------	------------------	------------------	------------------	------------------	------------------	------------------	--------------------	---------------------	---------------------

L-8499-A2

Standard Pillows: N/A **Finish Required:** Y
Standard Cushions: High Resilency 40 **Standard Finish:** N/A
COL: 40 square feet

Martine Arm Chair

Width: 23.5 **Depth:** 23 **Height:** 41.5
AH: 27 **SH:** 20 **SD:** 17.5 **IW:** 20
Weight: 30 / 35 lbs **Cube:** 12.98

1 1740	2 1800	3 1860	4 1920	5 1980	6 2040	8 2595	COL 1368	S Nail N/A	M Nail N/A
------------------	------------------	------------------	------------------	------------------	------------------	------------------	--------------------	----------------------	----------------------

L-8499-04

Standard Pillows: N/A **Finish Required:** Y
Standard Cushions: High Resilency 40 **Standard Finish:** N/A
COL: 40 square feet

Martine Arm Chair

Width: 23.5 **Depth:** 23 **Height:** 41.5
AH: 27 **SH:** 20 **SD:** 17.5 **IW:** 20
Weight: 30 / 35 lbs **Cube:** 12.98

1 1710	2 1770	3 1830	4 1890	5 1950	6 2010	8 2565	COL 1368	S Nail N/A	M Nail N/A
------------------	------------------	------------------	------------------	------------------	------------------	------------------	--------------------	----------------------	----------------------

L-8700-A2

Standard Pillows: N/A **Finish Required:** Y
Standard Cushions: High Resilency 40 **Standard Finish:** N/A
COL: 38.7 square feet

Preston Arm Chair

Width: 23.5 **Depth:** 23.5 **Height:** 38
AH: 25 **SH:** 19 **SD:** 19.5 **IW:** 20
Weight: 30 / 35 lbs **Cube:** 12.14

1 1770	2 1830	3 1890	4 1950	5 2010	6 2070	8 2610	COL 1278	S Nail 45	M Nail 60
------------------	------------------	------------------	------------------	------------------	------------------	------------------	--------------------	---------------------	---------------------

L-8700-A4

Standard Pillows: N/A **Finish Required:** Y
Standard Cushions: High Resilency 40 **Standard Finish:** N/A
COL: 38.7 square feet

Preston Arm Chair

Width: 23.5 **Depth:** 23.5 **Height:** 38
AH: 25 **SH:** 19 **SD:** 19.5 **IW:** 20
Weight: 30 / 35 lbs **Cube:** 12.14

1 1815	2 1875	3 1935	4 1995	5 2055	6 2115	8 2655	COL 1278	S Nail 45	M Nail 60
------------------	------------------	------------------	------------------	------------------	------------------	------------------	--------------------	---------------------	---------------------

L-8700-04

Standard Pillows: N/A **Finish Required:** Y
Standard Cushions: High Resilency 40 **Standard Finish:** N/A
COL: 40 square feet

Preston Arm Chair

Width: 23.5 **Depth:** 23.5 **Height:** 38
AH: 25 **SH:** 19 **SD:** 19.5 **IW:** 20
Weight: 30 / 35 lbs **Cube:** 12.14

1 1740	2 1800	3 1860	4 1920	5 1980	6 2040	8 2595	COL 1278	S Nail 45	M Nail 60
------------------	------------------	------------------	------------------	------------------	------------------	------------------	--------------------	---------------------	---------------------

LEATHER

L-8700-11

Preston Arm Stack Chair

Standard Pillows: N/A **Finish Required:** Y
Standard Cushions: High Resilency 40 **Standard Finish:** N/A
COL: 34 square feet
 Available in FairShield Plus Finishes Only.Warranted for stacking three high.

Width: 24.5 **Depth:** 22.5 **Height:** 35
AH: 26 **SH:** 19 **SD:** 18.5 **IW:** 20.5
Weight: 23 / 28 lbs **Cube:** 11.16

1	2	3	4	5	6	8	COL	S Nail	M Nail
1710	1770	1830	1890	1950	2010	2475	1278	45	60

L-8702-A2

Spiro Arm Chair

Standard Pillows: N/A **Finish Required:** Y
Standard Cushions: High Resilency 40 **Standard Finish:** N/A
COL: 34.2 square feet

Width: 23 **Depth:** 24 **Height:** 37.5
AH: 26.5 **SH:** 19 **SD:** 18.5 **IW:** 20.5
Weight: 30 / 35 lbs **Cube:** 11.97

1	2	3	4	5	6	8	COL	S Nail	M Nail
1875	1935	1995	2055	2115	2175	2655	1413	45	N/A

L-8702-04

Spiro Arm Chair

Standard Pillows: N/A **Finish Required:** Y
Standard Cushions: High Resilency 40 **Standard Finish:** N/A
COL: 40 square feet

Width: 23 **Depth:** 24 **Height:** 37.5
AH: 26.5 **SH:** 19 **SD:** 18.5 **IW:** 20.5
Weight: 30 / 35 lbs **Cube:** 11.97

1	2	3	4	5	6	8	COL	S Nail	M Nail
1845	1905	1965	2025	2085	2145	2700	1413	45	N/A

L-8705-A2

Taunton Arm Chair

Standard Pillows: N/A **Finish Required:** Y
Standard Cushions: High Resilency 40 **Standard Finish:** N/A
COL: 40 square feet

Width: 23 **Depth:** 23.5 **Height:** 39
AH: 25.5 **SH:** 19.5 **SD:** 18.5 **IW:** 19
Weight: 20 / 40 lbs **Cube:** 12.19

1	2	3	4	5	6	8	COL	S Nail	M Nail
1785	1845	1905	1965	2025	2085	2640	1368	45	N/A

L-8706-A2

Godfrey Arm Chair

Standard Pillows: N/A **Finish Required:** Y
Standard Cushions: High Resilency 40 **Standard Finish:** N/A
COL: 40 square feet

Width: 24 **Depth:** 23 **Height:** 38.5
AH: 25 **SH:** 18.5 **SD:** 18 **IW:** 20
Weight: 30 / 35 lbs **Cube:** 12.29

1	2	3	4	5	6	8	COL	S Nail	M Nail
1680	1740	1800	1860	1920	1980	2535	1173	N/A	N/A

L-8706-A4

Godfrey Arm Chair

Standard Pillows: N/A **Finish Required:** Y
Standard Cushions: High Resilency 40 **Standard Finish:** N/A
COL: 40 square feet

Width: 24 **Depth:** 23 **Height:** 38.5
AH: 25 **SH:** 18.5 **SD:** 18 **IW:** 20
Weight: 30 / 35 lbs **Cube:** 12.29

1	2	3	4	5	6	8	COL	S Nail	M Nail
1740	1800	1860	1920	1980	2040	2595	1173	N/A	N/A

L-8706-04

Godfrey Arm Chair

Standard Pillows: N/A **Finish Required:** Y
Standard Cushions: High Resilency 40 **Standard Finish:** N/A
COL: 40 square feet

Width: 24 **Depth:** 23 **Height:** 38.5
AH: 25 **SH:** 18.5 **SD:** 18 **IW:** 20
Weight: 30 / 35 lbs **Cube:** 12.29

1	2	3	4	5	6	8	COL	S Nail	M Nail
1650	1710	1770	1830	1890	1950	2505	1173	N/A	N/A

LEATHER

L-8707-01

Standard Pillows: N/A **Finish Required:** Y
Standard Cushions: High Resiliency 40 **Standard Finish:** N/A
COL: 45 square feet

Max Occasional Chair

Width: 25.5 **Depth:** 26 **Height:** 41.5
AH: 25.5 **SH:** 18.5 **SD:** 18.5 **IW:** 20.5
Weight: 45 / 50 lbs **Cube:** 15.92

1 2010	2 2085	3 2160	4 2235	5 2310	6 2385	8 3015	COL 1437	S Nail N/A	M Nail N/A
------------------	------------------	------------------	------------------	------------------	------------------	------------------	--------------------	----------------------	----------------------

L-8713-04

Standard Pillows: N/A **Finish Required:** Y
Standard Cushions: High Resiliency 30 **Standard Finish:** N/A
COL: 72.25 square feet

Maya Arm Chair

Width: 26 **Depth:** 28.5 **Height:** 42.5
AH: 27 **SH:** 20.5 **SD:** 18 **IW:** 18
Weight: 41 / 46 lbs **Cube:** 18.22

1 2640	2 2760	3 2880	4 3000	5 3120	6 3240	8 4245	COL 1989	S Nail 45	M Nail 60
------------------	------------------	------------------	------------------	------------------	------------------	------------------	--------------------	---------------------	---------------------

L-8713-05

Standard Pillows: N/A **Finish Required:** Y
Standard Cushions: High Resiliency 30 **Standard Finish:** N/A
COL: 50.15 square feet

Maya Side Chair

Width: 23 **Depth:** 28.5 **Height:** 42.5
AH: - **SH:** 20.5 **SD:** 18.5 **IW:** 23
Weight: 26 / 31 lbs **Cube:** 16.12

1 2025	2 2100	3 2175	4 2250	5 2325	6 2400	8 3090	COL 1680	S Nail 45	M Nail 60
------------------	------------------	------------------	------------------	------------------	------------------	------------------	--------------------	---------------------	---------------------

L-8714-A2

Standard Pillows: N/A **Finish Required:** Y
Standard Cushions: High Resiliency 55 **Standard Finish:** N/A
COL: 34 square feet

Yorkshire Arm Chair

Width: 25.5 **Depth:** 23.5 **Height:** 37.5
AH: 26 **SH:** 19.5 **SD:** 18 **IW:** 20
Weight: 30 / 35 lbs **Cube:** 13

1 1605	2 1665	3 1725	4 1785	5 1845	6 1905	8 2370	COL 1218	S Nail N/A	M Nail N/A
------------------	------------------	------------------	------------------	------------------	------------------	------------------	--------------------	----------------------	----------------------

L-8714-04

Standard Pillows: N/A **Finish Required:** Y
Standard Cushions: High Resiliency 55 **Standard Finish:** N/A
COL: 34 square feet

Yorkshire Arm Chair

Width: 25.5 **Depth:** 23.5 **Height:** 37.5
AH: 26 **SH:** 19.5 **SD:** 18 **IW:** 20
Weight: 30 / 35 lbs **Cube:** 13

1 1575	2 1635	3 1695	4 1755	5 1815	6 1875	8 2340	COL 1218	S Nail N/A	M Nail N/A
------------------	------------------	------------------	------------------	------------------	------------------	------------------	--------------------	----------------------	----------------------

L-8718-05

Standard Pillows: N/A **Finish Required:** Y
Standard Cushions: High Resiliency 40 **Standard Finish:** N/A
COL: 38.7 square feet

Wallace Side Chair

Width: 22 **Depth:** 24.5 **Height:** 38.5
AH: - **SH:** 19.5 **SD:** 19.5 **IW:** 22
Weight: 30 / 35 lbs **Cube:** 12

1 1815	2 1875	3 1935	4 1995	5 2055	6 2115	8 2655	COL 1338	S Nail 45	M Nail 60
------------------	------------------	------------------	------------------	------------------	------------------	------------------	--------------------	---------------------	---------------------

L-8719-A2

Standard Pillows: N/A **Finish Required:** Y
Standard Cushions: High Resiliency 55 **Standard Finish:** N/A
COL: 34 square feet

Kingsport Arm Chair

Width: 22 **Depth:** 26 **Height:** 35
AH: 25 **SH:** 19 **SD:** 18.5 **IW:** 19
Weight: 30 / 35 lbs **Cube:** 11.58

1 1710	2 1770	3 1830	4 1890	5 1950	6 2010	8 2475	COL 1314	S Nail N/A	M Nail N/A
------------------	------------------	------------------	------------------	------------------	------------------	------------------	--------------------	----------------------	----------------------

LEATHER

L-8720-A2

Albany Arm Chair

Standard Pillows: N/A Finish Required: Y
 Standard Cushions: High Resiliency 40 Standard Finish: N/A
 COL: 48.6 square feet

Width: 23 Depth: 23.5 Height: 31.5
 AH: 25.5 SH: 19.5 SD: 20.5 IW: 18.5
 Weight: 21 / 31 lbs Cube: 9.85

1	2	3	4	5	6	8	COL	S Nail	M Nail
2310	2385	2460	2535	2610	2685	3360	1644	45	60

L-8720-C6

Albany Counter Stool

Standard Pillows: N/A Finish Required: Y
 Standard Cushions: High Resiliency 40 Standard Finish: N/A
 COL: 43.2 square feet

Width: 23 Depth: 23.5 Height: 38
 AH: 32 SH: 26 SD: 20.5 IW: 18.5
 Weight: 35 / 45 lbs Cube: 11.88

1	2	3	4	5	6	8	COL	S Nail	M Nail
2370	2445	2520	2595	2670	2745	3345	1722	45	60

L-8720-04

Albany Arm Chair

Standard Pillows: N/A Finish Required: Y
 Standard Cushions: High Resiliency 40 Standard Finish: N/A
 COL: 43.2 square feet

Width: 23 Depth: 23.5 Height: 31.5
 AH: 25.5 SH: 19.5 SD: 20.5 IW: 18.5
 Weight: 21 / 31 lbs Cube: 9.85

1	2	3	4	5	6	8	COL	S Nail	M Nail
2280	2355	2430	2505	2580	2655	3255	1644	45	60

L-8720-06

PELLE PROVISIONS

Albany Bar Stool

Standard Pillows: N/A Finish Required: Y
 Standard Cushions: High Resiliency 40 Standard Finish: N/A
 COL: 43.2 square feet

Width: 23 Depth: 23.5 Height: 42
 AH: 36 SH: 30 SD: 20.5 IW: 18.5
 Weight: 40 / 51 lbs Cube: 17.77

1	2	3	4	5	6	8	COL	S Nail	M Nail
2295	2370	2445	2520	2595	2670	3270	1722	45	60

L-8721-A2

Brady Arm Chair

Standard Pillows: N/A Finish Required: Y
 Standard Cushions: High Resiliency 55 Standard Finish: N/A
 COL: 38.7 square feet

Width: 24 Depth: 25 Height: 39.5
 AH: 25.5 SH: 19 SD: 19 IW: 20
 Weight: 35 / 40 lbs Cube: 13.71

1	2	3	4	5	6	8	COL	S Nail	M Nail
1875	1935	1995	2055	2115	2175	2715	1290	45	60

L-8721-BC

Brady Bariatric Chair

Standard Pillows: N/A Finish Required: Y
 Standard Cushions: High Resiliency 55 Standard Finish: N/A
 COL: 51 square feet
 BIFMA tested up to 500 lbs. (static/dynamic)

Width: 34 Depth: 26 Height: 39
 AH: 25.5 SH: 19 SD: 19.5 IW: 30.5
 Weight: 45 / 64 lbs Cube: 19.95

1	2	3	4	5	6	8	COL	S Nail	M Nail
2265	2340	2415	2490	2565	2640	3345	1602	45	60

L-8721-04

Brady Arm Chair

Standard Pillows: N/A Finish Required: Y
 Standard Cushions: High Resiliency 55 Standard Finish: N/A
 COL: 40 square feet

Width: 24 Depth: 25 Height: 39.5
 AH: 25.5 SH: 19 SD: 19 IW: 20
 Weight: 35 / 40 lbs Cube: 13.71

1	2	3	4	5	6	8	COL	S Nail	M Nail
1845	1905	1965	2025	2085	2145	2700	1290	45	60

LEATHER

L-8721-05

Brady Side Chair

Standard Pillows: N/A **Finish Required:** Y
Standard Cushions: High Resilency 55 **Standard Finish:** N/A
COL: 40 square feet

Width: 24 **Depth:** 24.5 **Height:** 39
AH: - **SH:** 19.5 **SD:** 19.5 **IW:** 24
Weight: 30 / 35 lbs **Cube:** 13.27

1 1740	2 1800	3 1860	4 1920	5 1980	6 2040	8 2595	COL 1233	S Nail 45	M Nail 60
------------------	------------------	------------------	------------------	------------------	------------------	------------------	--------------------	---------------------	---------------------

L-8726-01

Nora Occasional Chair

Standard Pillows: N/A **Finish Required:** Y
Standard Cushions: High Resilency 40 **Standard Finish:** N/A
COL: 53.1 square feet

Width: 24.5 **Depth:** 25.5 **Height:** 40.5
AH: 26 **SH:** 19.5 **SD:** 19.5 **IW:** 19.5
Weight: 35 / 40 lbs **Cube:** 14.64

1 1995	2 2085	3 2175	4 2265	5 2355	6 2445	8 3180	COL 1422	S Nail N/A	M Nail N/A
------------------	------------------	------------------	------------------	------------------	------------------	------------------	--------------------	----------------------	----------------------

L-8727-A2

Murphy Arm Chair

Standard Pillows: N/A **Finish Required:** Y
Standard Cushions: High Resilency 40 **Standard Finish:** N/A
COL: 38.7 square feet

Width: 23.5 **Depth:** 22.5 **Height:** 34.5
AH: 26 **SH:** 18.5 **SD:** 18.5 **IW:** 18
Weight: 35 / 40 lbs **Cube:** 10.55

1 2190	2 2250	3 2310	4 2370	5 2430	6 2490	8 3030	COL 1674	S Nail 45	M Nail N/A
------------------	------------------	------------------	------------------	------------------	------------------	------------------	--------------------	---------------------	----------------------

L-8727-A4

Murphy Arm Chair

Standard Pillows: N/A **Finish Required:** Y
Standard Cushions: High Resilency 40 **Standard Finish:** N/A
COL: 38.7 square feet

Width: 23.5 **Depth:** 22.5 **Height:** 34.5
AH: 26 **SH:** 18.5 **SD:** 18.5 **IW:** 18
Weight: 22 / 27 lbs **Cube:** 10.55

1 2250	2 2310	3 2370	4 2430	5 2490	6 2550	8 3090	COL 1674	S Nail 45	M Nail N/A
------------------	------------------	------------------	------------------	------------------	------------------	------------------	--------------------	---------------------	----------------------

L-8727-04

Murphy Arm Chair

Standard Pillows: N/A **Finish Required:** Y
Standard Cushions: High Resilency 40 **Standard Finish:** N/A
COL: 38.7 square feet

Width: 23.5 **Depth:** 22.5 **Height:** 34.5
AH: 26 **SH:** 18.5 **SD:** 18.5 **IW:** 18
Weight: 20 / 30 lbs **Cube:** 10.55

1 2160	2 2220	3 2280	4 2340	5 2400	6 2460	8 3000	COL 1674	S Nail 45	M Nail N/A
------------------	------------------	------------------	------------------	------------------	------------------	------------------	--------------------	---------------------	----------------------

L-8729-05

Douglas Side Chair

Standard Pillows: N/A **Finish Required:** Y
Standard Cushions: High Resilency 40 **Standard Finish:** N/A
COL: 29 square feet

Width: 20.5 **Depth:** 21 **Height:** 31
AH: - **SH:** 18.5 **SD:** 19 **IW:** 20.5
Weight: 25 / 30 lbs **Cube:** 7.72

1 1590	2 1635	3 1680	4 1725	5 1770	6 1815	8 2220	COL 1218	S Nail 45	M Nail N/A
------------------	------------------	------------------	------------------	------------------	------------------	------------------	--------------------	---------------------	----------------------

L-8730-A2

Edgemont Arm Chair

Standard Pillows: N/A **Finish Required:** Y
Standard Cushions: High Resilency 40 **Standard Finish:** N/A
COL: 34.2 square feet

Width: 23.5 **Depth:** 25.5 **Height:** 36.5
AH: 25.5 **SH:** 18.5 **SD:** 18.5 **IW:** 20
Weight: 30 / 35 lbs **Cube:** 12.65

1 1785	2 1845	3 1905	4 1965	5 2025	6 2085	8 2565	COL 1338	S Nail N/A	M Nail N/A
------------------	------------------	------------------	------------------	------------------	------------------	------------------	--------------------	----------------------	----------------------

LEATHER

L-8730-04

Standard Pillows: N/A **Finish Required:** Y
Standard Cushions: High Resiliency 40 **Standard Finish:** N/A
COL: 34.2 square feet

Edgemont Arm Chair

Width: 23.5 **Depth:** 25.5 **Height:** 36.5
AH: 25.5 **SH:** 18.5 **SD:** 18.5 **IW:** 20
Weight: 30 / 35 lbs **Cube:** 12.65

1 1755	2 1815	3 1875	4 1935	5 1995	6 2055	8 2535	COL 1338	S Nail N/A	M Nail N/A
------------------	------------------	------------------	------------------	------------------	------------------	------------------	--------------------	----------------------	----------------------

L-8731-01

Standard Pillows: N/A **Finish Required:** Y
Standard Cushions: High Resiliency 30 **Standard Finish:** N/A
COL: 77.35 square feet

Myla Occasional Chair

Width: 28 **Depth:** 31 **Height:** 36.5
AH: 25 **SH:** 19 **SD:** 19.5 **IW:** 18.5
Weight: 50 / 60 lbs **Cube:** 18.33

1 2685	2 2805	3 2925	4 3045	5 3165	6 3285	8 4350	COL 1845	S Nail 45	M Nail 60
------------------	------------------	------------------	------------------	------------------	------------------	------------------	--------------------	---------------------	---------------------

L-8732-A2

Standard Pillows: N/A **Finish Required:** Y
Standard Cushions: High Resiliency 40 **Standard Finish:** N/A
COL: 34.2 square feet

Fayette Occasional Chair

Width: 26 **Depth:** 24.5 **Height:** 33
AH: 26 **SH:** 20 **SD:** 20.5 **IW:** 21
Weight: 35 / 40 lbs **Cube:** 12.16

1 1875	2 1935	3 1995	4 2055	5 2115	6 2175	8 2655	COL 1452	S Nail Std.	M Nail N/A
------------------	------------------	------------------	------------------	------------------	------------------	------------------	--------------------	-----------------------	----------------------

L-8732-A4

Standard Pillows: N/A **Finish Required:** Y
Standard Cushions: High Resiliency 40 **Standard Finish:** N/A
COL: 34.2 square feet

Fayette Occasional Chair

Width: 26 **Depth:** 24.5 **Height:** 33
AH: 26 **SH:** 19.5 **SD:** 19.5 **IW:** 21
Weight: 35 / 45 lbs **Cube:** 15.74

1 1935	2 1995	3 2055	4 2115	5 2175	6 2235	8 2715	COL 1452	S Nail Std.	M Nail N/A
------------------	------------------	------------------	------------------	------------------	------------------	------------------	--------------------	-----------------------	----------------------

L-8732-01

Standard Pillows: N/A **Finish Required:** Y
Standard Cushions: High Resiliency 40 **Standard Finish:** N/A
COL: 34.2 square feet

Fayette Occasional Chair

Width: 26 **Depth:** 24.5 **Height:** 33
AH: 26 **SH:** 20 **SD:** 20.5 **IW:** 21
Weight: 35 / 40 lbs **Cube:** 12.16

1 1845	2 1905	3 1965	4 2025	5 2085	6 2145	8 2625	COL 1452	S Nail Std.	M Nail N/A
------------------	------------------	------------------	------------------	------------------	------------------	------------------	--------------------	-----------------------	----------------------

L-8735-A2

Standard Pillows: N/A **Finish Required:** Y
Standard Cushions: High Resiliency 40 **Standard Finish:** N/A
COL: 72 square feet

Vanessa Arm Chair

Width: 26 **Depth:** 27.5 **Height:** 40
AH: 25.5 **SH:** 18.5 **SD:** 21 **IW:** 20
Weight: 33 / 47 lbs **Cube:** 16.55

1 2595	2 2715	3 2835	4 2955	5 3075	6 3195	8 4185	COL 1746	S Nail N/A	M Nail N/A
------------------	------------------	------------------	------------------	------------------	------------------	------------------	--------------------	----------------------	----------------------

L-8735-A4

Standard Pillows: N/A **Finish Required:** Y
Standard Cushions: High Resiliency 40 **Standard Finish:** N/A
COL: 68 square feet

Vanessa Arm Chair

Width: 26 **Depth:** 27.5 **Height:** 40
AH: 25.5 **SH:** 18.5 **SD:** 21 **IW:** 20
Weight: 33 / 46 lbs **Cube:** 16.55

1 2640	2 2745	3 2850	4 2955	5 3060	6 3165	8 4110	COL 1746	S Nail N/A	M Nail N/A
------------------	------------------	------------------	------------------	------------------	------------------	------------------	--------------------	----------------------	----------------------

LEATHER

L-8735-04

Vanessa Arm Chair

Standard Pillows: N/A **Finish Required:** Y
Standard Cushions: High Resiliency 40 **Standard Finish:** N/A
COL: 68 square feet

Width: 26 **Depth:** 27.5 **Height:** 40
AH: 25.5 **SH:** 18.5 **SD:** 21 **IW:** 20
Weight: 33 / 46 lbs **Cube:** 16.55

1 2565	2 2670	3 2775	4 2880	5 2985	6 3090	8 4035	COL 1746	S Nail N/A	M Nail N/A
-----------	-----------	-----------	-----------	-----------	-----------	-----------	-------------	---------------	---------------

L-8735-05

Vanessa Side Chair

Standard Pillows: N/A **Finish Required:** Y
Standard Cushions: High Resiliency 40 **Standard Finish:** N/A
COL: 62 square feet

Width: 25.5 **Depth:** 28 **Height:** 37.75
AH: 18 **SH:** 18 **SD:** 19.75 **IW:** 20.5
Weight: 32 / 44 lbs **Cube:** 15.59

1 2400	2 2505	3 2610	4 2715	5 2820	6 2925	8 3780	COL 1716	S Nail N/A	M Nail N/A
-----------	-----------	-----------	-----------	-----------	-----------	-----------	-------------	---------------	---------------

L-8740-A2

Anthony Arm Chair

Standard Pillows: N/A **Finish Required:** Y
Standard Cushions: High Resiliency 40 **Standard Finish:** N/A
COL: 48.6 square feet
Standard 2" Channel Quilt on Outside Back

Width: 24 **Depth:** 26 **Height:** 33
AH: 24.5 **SH:** 19.5 **SD:** 20 **IW:** 18
Weight: 24 / 37 lbs **Cube:** 11.91

1 2475	2 2550	3 2625	4 2700	5 2775	6 2850	8 3525	COL 1752	S Nail 60	M Nail 75
-----------	-----------	-----------	-----------	-----------	-----------	-----------	-------------	--------------	--------------

L-8740-A4

Anthony Arm Chair

Standard Pillows: N/A **Finish Required:** Y
Standard Cushions: High Resiliency 40 **Standard Finish:** N/A
COL: 48.6 square feet
Standard 2" Channel Quilt on Outside Back

Width: 24 **Depth:** 26 **Height:** 33
AH: 24.5 **SH:** 19.5 **SD:** 20 **IW:** 18
Weight: 26 / 36 lbs **Cube:** 11.91

1 2520	2 2595	3 2670	4 2745	5 2820	6 2895	8 3570	COL 1752	S Nail 60	M Nail 75
-----------	-----------	-----------	-----------	-----------	-----------	-----------	-------------	--------------	--------------

L-8740-C7

Anthony Counter Stool

Standard Pillows: N/A **Finish Required:** Y
Standard Cushions: High Resiliency 40 **Standard Finish:** N/A
COL: 43.2 square feet
Standard 2" Channel Quilt on Outside Back

Width: 21.5 **Depth:** 22 **Height:** 39.5
AH: 30 **SH:** 26 **SD:** 17.5 **IW:** 17.5
Weight: 35 / 45 lbs **Cube:** 10.81

1 2445	2 2520	3 2595	4 2670	5 2745	6 2820	8 3420	COL 1857	S Nail 60	M Nail 75
-----------	-----------	-----------	-----------	-----------	-----------	-----------	-------------	--------------	--------------

L-8740-04

Anthony Arm Chair

Standard Pillows: N/A **Finish Required:** Y
Standard Cushions: High Resiliency 40 **Standard Finish:** N/A
COL: 51 square feet
Standard 2" Channel Quilt on Outside Back

Width: 24 **Depth:** 26 **Height:** 33
AH: 24.5 **SH:** 19.5 **SD:** 20 **IW:** 18
Weight: 24 / 34 lbs **Cube:** 11.91

1 2445	2 2520	3 2595	4 2670	5 2745	6 2820	8 3525	COL 1752	S Nail 60	M Nail 75
-----------	-----------	-----------	-----------	-----------	-----------	-----------	-------------	--------------	--------------

L-8740-05

Anthony Side Chair

Standard Pillows: N/A **Finish Required:** Y
Standard Cushions: High Resiliency 40 **Standard Finish:** N/A
COL: 45 square feet
Standard 2" Channel Quilt on Outside Back

Width: 22.5 **Depth:** 25 **Height:** 33.5
AH: 20 **SH:** 19.5 **SD:** 19.5 **IW:** 18
Weight: 23 / 33 lbs **Cube:** 10.9

1 2310	2 2385	3 2460	4 2535	5 2610	6 2685	8 3315	COL 1722	S Nail 60	M Nail 75
-----------	-----------	-----------	-----------	-----------	-----------	-----------	-------------	--------------	--------------

LEATHER

L-8740-07

PELLE PROVISIONS

Anthony Bar Stool

Width: 21.5 Depth: 22 Height: 43.5

AH: 30 SH: 30 SD: 17.5 IW: 17.5

Weight: 40 / 51 lbs Cube: 17.77

Standard Pillows: N/A Finish Required: Y

Standard Cushions: High Resilency 40 Standard Finish: N/A

COL: 45 square feet

Standard 2" Channel Quilt on Outside Back

1	2	3	4	5	6	8	COL	S Nail	M Nail
2400	2475	2550	2625	2700	2775	3405	1857	60	75

L-8741-A2

Anthony Arm Chair

Width: 24 Depth: 26 Height: 33

AH: 24.5 SH: 19.5 SD: 20 IW: 18

Weight: 25 / 38 lbs Cube: 11.91

Standard Pillows: N/A Finish Required: Y

Standard Cushions: High Resilency 40 Standard Finish: N/A

COL: 48.6 square feet

1	2	3	4	5	6	8	COL	S Nail	M Nail
2400	2475	2550	2625	2700	2775	3450	1752	60	75

L-8741-A4

Anthony Arm Chair

Width: 24 Depth: 26 Height: 33

AH: 24.5 SH: 19.5 SD: 20 IW: 18

Weight: 26 / 39 lbs Cube: 11.91

Standard Pillows: N/A Finish Required: Y

Standard Cushions: High Resilency 40 Standard Finish: N/A

COL: 48.6 square feet

1	2	3	4	5	6	8	COL	S Nail	M Nail
2460	2535	2610	2685	2760	2835	3510	1752	60	75

L-8741-C7

Anthony Counter Stool

Width: 21.5 Depth: 22 Height: 39.5

AH: 30 SH: 26.5 SD: 17.5 IW: 17.5

Weight: 35 / 34 lbs Cube: 10.81

Standard Pillows: N/A Finish Required: Y

Standard Cushions: High Resilency 40 Standard Finish: N/A

COL: 43.2 square feet

1	2	3	4	5	6	8	COL	S Nail	M Nail
2355	2430	2505	2580	2655	2730	3330	1857	60	75

L-8741-04

Anthony Arm Chair

Width: 24 Depth: 26 Height: 33

AH: 24.5 SH: 19.5 SD: 20 IW: 18

Weight: 24 / 29 lbs Cube: 11.91

Standard Pillows: N/A Finish Required: Y

Standard Cushions: High Resilency 40 Standard Finish: N/A

COL: 51 square feet

1	2	3	4	5	6	8	COL	S Nail	M Nail
2370	2445	2520	2595	2670	2745	3450	1752	60	75

L-8741-05

Anthony Side Chair

Width: 22.5 Depth: 25 Height: 33.5

AH: 20 SH: 19.5 SD: 19.5 IW: 18

Weight: 23 / 33 lbs Cube: 10.9

Standard Pillows: N/A Finish Required: Y

Standard Cushions: High Resilency 40 Standard Finish: N/A

COL: 45 square feet

1	2	3	4	5	6	8	COL	S Nail	M Nail
2250	2325	2400	2475	2550	2625	3255	1722	60	75

L-8741-07

Anthony Bar Stool

Width: 21.5 Depth: 22 Height: 43.5

AH: 30 SH: 30 SD: 17.5 IW: 17.5

Weight: 25 / 36 lbs Cube: 11.9

Standard Pillows: N/A Finish Required: Y

Standard Cushions: High Resilency 40 Standard Finish: N/A

COL: 40 square feet

1	2	3	4	5	6	8	COL	S Nail	M Nail
2355	2415	2475	2535	2595	2655	3210	1857	60	75

LEATHER

L-8742-A2

Proctor Arm Chair

Standard Pillows: N/A Finish Required: Y
 Standard Cushions: High Resiliency 40 Standard Finish: N/A
 COL: 34.2 square feet

Width: 24 Depth: 23 Height: 35
 AH: 26.5 SH: 19 SD: 18.5 IW: 20
 Weight: 26 / 31 lbs Cube: 11.18

1	2	3	4	5	6	8	COL	S Nail	M Nail
1770	1830	1890	1950	2010	2070	2550	1308	45	N/A

L-8742-C6

Proctor Counter Stool

Standard Pillows: N/A Finish Required: Y
 Standard Cushions: High Resiliency 40 Standard Finish: N/A
 COL: 34.2 square feet

Width: 22 Depth: 22.5 Height: 40
 AH: 31.5 SH: 26 SD: 18 IW: 19
 Weight: 23 / 33 lbs Cube: 11.45

1	2	3	4	5	6	8	COL	S Nail	M Nail
1905	1965	2025	2085	2145	2205	2685	1503	45	N/A

L-8742-04

Proctor Arm Chair

Standard Pillows: N/A Finish Required: Y
 Standard Cushions: High Resiliency 40 Standard Finish: N/A
 COL: 40 square feet

Width: 24 Depth: 23 Height: 35
 AH: 26.5 SH: 19 SD: 18.5 IW: 20
 Weight: 30 / 35 lbs Cube: 11.18

1	2	3	4	5	6	8	COL	S Nail	M Nail
1740	1800	1860	1920	1980	2040	2595	1308	45	N/A

L-8742-06

Proctor Bar Stool

Standard Pillows: N/A Finish Required: Y
 Standard Cushions: High Resiliency 40 Standard Finish: N/A
 COL: 40 square feet

Width: 22 Depth: 22.5 Height: 44
 AH: 35.5 SH: 30 SD: 18 IW: 19
 Weight: 25 / 35 lbs Cube: 12.6

1	2	3	4	5	6	8	COL	S Nail	M Nail
1905	1965	2025	2085	2145	2205	2760	1503	45	N/A

L-8744-A2

Langston Arm Chair

Standard Pillows: N/A Finish Required: Y
 Standard Cushions: High Resiliency 40 Standard Finish: N/A
 COL: 38.7 square feet

Width: 24.5 Depth: 25 Height: 38.5
 AH: 25 SH: 19 SD: 19 IW: 20.5
 Weight: 30 / 40 lbs Cube: 13.64

1	2	3	4	5	6	8	COL	S Nail	M Nail
1755	1815	1875	1935	1995	2055	2595	1314	45	N/A

L-8744-A4

Langston Arm Chair

Standard Pillows: N/A Finish Required: Y
 Standard Cushions: High Resiliency 40 Standard Finish: N/A
 COL: 38.7 square feet

Width: 24.5 Depth: 25 Height: 38.5
 AH: 25 SH: 19 SD: 19 IW: 20.5
 Weight: 30 / 40 lbs Cube: 13.64

1	2	3	4	5	6	8	COL	S Nail	M Nail
1800	1860	1920	1980	2040	2100	2640	1314	45	N/A

L-8744-04

Langston Arm Chair

Standard Pillows: N/A Finish Required: Y
 Standard Cushions: High Resiliency 40 Standard Finish: N/A
 COL: 45 square feet

Width: 24.5 Depth: 25 Height: 38.5
 AH: 25 SH: 19 SD: 19 IW: 20.5
 Weight: 30 / 40 lbs Cube: 13.64

1	2	3	4	5	6	8	COL	S Nail	M Nail
1710	1785	1860	1935	2010	2085	2715	1314	45	N/A

LEATHER

L-8745-A2

Potter Arm Chair

Standard Pillows: N/A Finish Required: Y
 Standard Cushions: High Resiliency 40 Standard Finish: N/A
 COL: 34.2 square feet

Width: 24 Depth: 23 Height: 35
 AH: 26.5 SH: 19 SD: 18.5 IW: 20
 Weight: 30 / 40 lbs Cube: 11.18

1	2	3	4	5	6	8	COL	S Nail	M Nail
1725	1785	1845	1905	1965	2025	2505	1308	45	N/A

L-8745-C6

Potter Counter Stool

Standard Pillows: N/A Finish Required: Y
 Standard Cushions: High Resiliency 40 Standard Finish: N/A
 COL: 34.2 square feet

Width: 22 Depth: 22.5 Height: 40
 AH: 31.5 SH: 26 SD: 18 IW: 19
 Weight: 25 / 36 lbs Cube: 11.45

1	2	3	4	5	6	8	COL	S Nail	M Nail
1845	1905	1965	2025	2085	2145	2625	1503	45	N/A

L-8745-04

Potter Arm Chair

Standard Pillows: N/A Finish Required: Y
 Standard Cushions: High Resiliency 40 Standard Finish: N/A
 COL: 40 square feet

Width: 24 Depth: 23 Height: 35
 AH: 26.5 SH: 19 SD: 18.5 IW: 20
 Weight: 30 / 40 lbs Cube: 11.18

1	2	3	4	5	6	8	COL	S Nail	M Nail
1695	1755	1815	1875	1935	1995	2550	1308	45	N/A

L-8745-06

Potter Bar Stool

Standard Pillows: N/A Finish Required: Y
 Standard Cushions: High Resiliency 40 Standard Finish: N/A
 COL: 40 square feet

Width: 22 Depth: 22.5 Height: 44
 AH: 35.5 SH: 30 SD: 18 IW: 19
 Weight: 25 / 38 lbs Cube: 12.6

1	2	3	4	5	6	8	COL	S Nail	M Nail
1845	1905	1965	2025	2085	2145	2700	1503	45	N/A

L-8747-A2

Garland Arm Chair

Standard Pillows: N/A Finish Required: Y
 Standard Cushions: High Resiliency 40 Standard Finish: N/A
 COL: 34.2 square feet

Width: 23.5 Depth: 24.5 Height: 39
 AH: 25.5 SH: 19 SD: 18 IW: 19
 Weight: 20 / 30 lbs Cube: 12.99

1	2	3	4	5	6	8	COL	S Nail	M Nail
1770	1830	1890	1950	2010	2070	2550	1338	45	N/A

L-8747-A4

Garland Arm Chair

Standard Pillows: N/A Finish Required: Y
 Standard Cushions: High Resiliency 40 Standard Finish: N/A
 COL: 34.2 square feet

Width: 23.5 Depth: 24.5 Height: 39
 AH: 25.5 SH: 19 SD: 18 IW: 19
 Weight: 35 / 40 lbs Cube: 12.99

1	2	3	4	5	6	8	COL	S Nail	M Nail
1815	1875	1935	1995	2055	2115	2595	1338	45	N/A

L-8747-04

Garland Arm Chair

Standard Pillows: N/A Finish Required: Y
 Standard Cushions: High Resiliency 40 Standard Finish: N/A
 COL: 34.2 square feet

Width: 23.5 Depth: 24.5 Height: 39
 AH: 25.5 SH: 19 SD: 18 IW: 19
 Weight: 35 / 40 lbs Cube: 12.99

1	2	3	4	5	6	8	COL	S Nail	M Nail
1740	1800	1860	1920	1980	2040	2520	1338	45	N/A

LEATHER

L-8747-40

Standard Pillows: N/A **Finish Required:** Y
Standard Cushions: High Resiliency 40 **Standard Finish:** N/A
COL: 63.75 square feet

Garland Settee

Width: 49.5 **Depth:** 24 **Height:** 34
AH: 25.5 **SH:** 18.5 **SD:** 18 **IW:** 44.5
Weight: 50 / 60 lbs **Cube:** 23.37

1 2700	2 2805	3 2910	4 3015	5 3120	6 3225	8 4110	COL 2046	S Nail 60	M Nail 45
------------------	------------------	------------------	------------------	------------------	------------------	------------------	--------------------	---------------------	---------------------

L-8749-A2

Standard Pillows: N/A **Finish Required:** Y
Standard Cushions: High Resiliency 40 **Standard Finish:** N/A
COL: 45 square feet

Palmer Arm Chair

Width: 24 **Depth:** 24 **Height:** 38.5
AH: 25 **SH:** 20 **SD:** 18 **IW:** 19.5
Weight: 24 / 34 lbs **Cube:** 12.83

1 2265	2 2340	3 2415	4 2490	5 2565	6 2640	8 3270	COL 1722	S Nail 45	M Nail N/A
------------------	------------------	------------------	------------------	------------------	------------------	------------------	--------------------	---------------------	----------------------

L-8749-A4

Standard Pillows: N/A **Finish Required:** Y
Standard Cushions: High Resiliency 40 **Standard Finish:** N/A
COL: 45 square feet

Palmer Arm Chair

Width: 24 **Depth:** 24 **Height:** 38.5
AH: 25 **SH:** 20 **SD:** 18 **IW:** 19.5
Weight: 25 / 38 lbs **Cube:** 12.83

1 2310	2 2385	3 2460	4 2535	5 2610	6 2685	8 3315	COL 1722	S Nail 45	M Nail N/A
------------------	------------------	------------------	------------------	------------------	------------------	------------------	--------------------	---------------------	----------------------

L-8749-CO

Standard Pillows: N/A **Finish Required:** Y
Standard Cushions: High Resiliency 40 **Standard Finish:** N/A
COL: 43.2 square feet

Palmer Arm Chair with Clean Out

Width: 24 **Depth:** 24 **Height:** 38.5
AH: 25 **SH:** 20 **SD:** 18 **IW:** 19.5
Weight: 23 / 33 lbs **Cube:** 12.83

1 2310	2 2385	3 2460	4 2535	5 2610	6 2685	8 3285	COL 1722	S Nail 45	M Nail N/A
------------------	------------------	------------------	------------------	------------------	------------------	------------------	--------------------	---------------------	----------------------

L-8749-C2

Standard Pillows: N/A **Finish Required:** Y
Standard Cushions: High Resiliency 40 **Standard Finish:** N/A
COL: 43.2 square feet

Palmer Arm Chair

Width: 24 **Depth:** 24 **Height:** 38.5
AH: 25 **SH:** 20 **SD:** 18 **IW:** 19.5
Weight: 23 / 33 lbs **Cube:** 12.83

1 2340	2 2415	3 2490	4 2565	5 2640	6 2715	8 3315	COL 1722	S Nail 45	M Nail N/A
------------------	------------------	------------------	------------------	------------------	------------------	------------------	--------------------	---------------------	----------------------

L-8749-C4

Standard Pillows: N/A **Finish Required:** Y
Standard Cushions: High Resiliency 40 **Standard Finish:** N/A
COL: 43.2 square feet

Palmer Arm Chair

Width: 24 **Depth:** 24 **Height:** 38.5
AH: 25 **SH:** 20 **SD:** 18 **IW:** 19.5
Weight: 23 / 36 lbs **Cube:** 12.83

1 2400	2 2475	3 2550	4 2625	5 2700	6 2775	8 3375	COL 1722	S Nail 45	M Nail N/A
------------------	------------------	------------------	------------------	------------------	------------------	------------------	--------------------	---------------------	----------------------

L-8749-04

Standard Pillows: N/A **Finish Required:** Y
Standard Cushions: High Resiliency 40 **Standard Finish:** N/A
COL: 45 square feet

Palmer Arm Chair

Width: 24 **Depth:** 24 **Height:** 38.5
AH: 25 **SH:** 20 **SD:** 18 **IW:** 19.5
Weight: 23 / 36 lbs **Cube:** 12.83

1 2220	2 2295	3 2370	4 2445	5 2520	6 2595	8 3225	COL 1722	S Nail 45	M Nail N/A
------------------	------------------	------------------	------------------	------------------	------------------	------------------	--------------------	---------------------	----------------------

LEATHER

L-8750-A2

Standard Pillows: N/A **Finish Required:** Y
Standard Cushions: High Resiliency 40 **Standard Finish:** N/A
COL: 45 square feet

Jade Arm Chair

Width: 23 **Depth:** 25 **Height:** 35
AH: 25 **SH:** 18.5 **SD:** 18.5 **IW:** 19
Weight: 22 / 35 lbs **Cube:** 11.64

1 1935	2 2010	3 2085	4 2160	5 2235	6 2310	8 2940	COL 1470	S Nail N/A	M Nail N/A
-----------	-----------	-----------	-----------	-----------	-----------	-----------	-------------	---------------	---------------

L-8750-A4

Standard Pillows: N/A **Finish Required:** Y
Standard Cushions: High Resiliency 40 **Standard Finish:** N/A
COL: 45 square feet

Jade Arm Chair

Width: 23 **Depth:** 25 **Height:** 35
AH: 25 **SH:** 18.5 **SD:** 18.5 **IW:** 19
Weight: 22 / 32 lbs **Cube:** 11.64

1 1980	2 2055	3 2130	4 2205	5 2280	6 2355	8 2985	COL 1470	S Nail N/A	M Nail N/A
-----------	-----------	-----------	-----------	-----------	-----------	-----------	-------------	---------------	---------------

L-8750-04

Standard Pillows: N/A **Finish Required:** Y
Standard Cushions: High Resiliency 40 **Standard Finish:** N/A
COL: 45 square feet

Jade Arm Chair

Width: 23 **Depth:** 25 **Height:** 35
AH: 25 **SH:** 18.5 **SD:** 18.5 **IW:** 19
Weight: 22 / 32 lbs **Cube:** 11.64

1 1905	2 1980	3 2055	4 2130	5 2205	6 2280	8 2910	COL 1470	S Nail N/A	M Nail N/A
-----------	-----------	-----------	-----------	-----------	-----------	-----------	-------------	---------------	---------------

L-8750-05

Standard Pillows: N/A **Finish Required:** Y
Standard Cushions: High Resiliency 40 **Standard Finish:** N/A
COL: 38.7 square feet

Jade Side Chair

Width: 21.5 **Depth:** 27 **Height:** 37.5
AH: - **SH:** 19 **SD:** 17.5 **IW:** 21.5
Weight: 19 / 29 lbs **Cube:** 12.59

1 1860	2 1920	3 1980	4 2040	5 2100	6 2160	8 2700	COL 1440	S Nail N/A	M Nail N/A
-----------	-----------	-----------	-----------	-----------	-----------	-----------	-------------	---------------	---------------

L-8751-A2

Standard Pillows: N/A **Finish Required:** Y
Standard Cushions: High Resiliency 40 **Standard Finish:** N/A
COL: 34 square feet

Jude Arm Chair

Width: 23 **Depth:** 25 **Height:** 35
AH: 25 **SH:** 18.5 **SD:** 18.5 **IW:** 19
Weight: 22 / 32 lbs **Cube:** 11.64

1 1950	2 2010	3 2070	4 2130	5 2190	6 2250	8 2715	COL 1470	S Nail N/A	M Nail N/A
-----------	-----------	-----------	-----------	-----------	-----------	-----------	-------------	---------------	---------------

L-8751-04

Standard Pillows: N/A **Finish Required:** Y
Standard Cushions: High Resiliency 40 **Standard Finish:** N/A
COL: 34 square feet

Jude Arm Chair

Width: 23 **Depth:** 25 **Height:** 35
AH: 25 **SH:** 18.5 **SD:** 18.5 **IW:** 19
Weight: 22 / 32 lbs **Cube:** 11.64

1 1920	2 1980	3 2040	4 2100	5 2160	6 2220	8 2685	COL 1470	S Nail N/A	M Nail N/A
-----------	-----------	-----------	-----------	-----------	-----------	-----------	-------------	---------------	---------------

L-8751-05

Standard Pillows: N/A **Finish Required:** Y
Standard Cushions: High Resiliency 40 **Standard Finish:** N/A
COL: 38.7 square feet

Jude Side Chair

Width: 21.5 **Depth:** 27 **Height:** 37.5
AH: - **SH:** 19 **SD:** 17.5 **IW:** 21.5
Weight: 19 / 29 lbs **Cube:** 12.59

1 1875	2 1935	3 1995	4 2055	5 2115	6 2175	8 2715	COL 1440	S Nail N/A	M Nail N/A
-----------	-----------	-----------	-----------	-----------	-----------	-----------	-------------	---------------	---------------

LEATHER

L-8755-A2

Standard Pillows: N/A **Finish Required:** Y
Standard Cushions: High Resilency 55 **Standard Finish:** N/A
COL: 34.2 square feet

Opel Arm Chair

Width: 25.5 **Depth:** 22.5 **Height:** 39.5
AH: 26 **SH:** 19.5 **SD:** 20 **IW:** 23
Weight: 35 / 40 lbs **Cube:** 13.11

1 1785	2 1845	3 1905	4 1965	5 2025	6 2085	8 2565	COL 1320	S Nail N/A	M Nail N/A
------------------	------------------	------------------	------------------	------------------	------------------	------------------	--------------------	----------------------	----------------------

L-8755-A4

Standard Pillows: N/A **Finish Required:** Y
Standard Cushions: High Resilency 55 **Standard Finish:** N/A
COL: 34.2 square feet

Opel Arm Chair

Width: 25.5 **Depth:** 22.5 **Height:** 39.5
AH: 26 **SH:** 19.5 **SD:** 20 **IW:** 23
Weight: 40 / 45 lbs **Cube:** 13.11

1 1830	2 1890	3 1950	4 2010	5 2070	6 2130	8 2610	COL 1320	S Nail N/A	M Nail N/A
------------------	------------------	------------------	------------------	------------------	------------------	------------------	--------------------	----------------------	----------------------

L-8762-A2

Standard Pillows: N/A **Finish Required:** Y
Standard Cushions: High Resilency 40 **Standard Finish:** N/A
COL: 51 square feet

Laguna Occasional Chair

Width: 24 **Depth:** 23 **Height:** 36.5
AH: 25.5 **SH:** 19.5 **SD:** 18 **IW:** 20.5
Weight: 35 / 40 lbs **Cube:** 11.65

1 2010	2 2085	3 2160	4 2235	5 2310	6 2385	8 3090	COL 1476	S Nail N/A	M Nail N/A
------------------	------------------	------------------	------------------	------------------	------------------	------------------	--------------------	----------------------	----------------------

L-8762-E1

Standard Pillows: N/A **Finish Required:** Y
Standard Cushions: High Resilency 40 **Standard Finish:** N/A
COL: 51 square feet
 Features an EasyClean Seat.

Laguna EasyClean Occasional Chair

Width: 24 **Depth:** 23 **Height:** 36.5
AH: 25.5 **SH:** 19 **SD:** 18 **IW:** 20.5
Weight: 35 / 40 lbs **Cube:** 11.65

1 2010	2 2085	3 2160	4 2235	5 2310	6 2385	8 3090	COL 1476	S Nail N/A	M Nail N/A
------------------	------------------	------------------	------------------	------------------	------------------	------------------	--------------------	----------------------	----------------------

L-8762-E2

Standard Pillows: N/A **Finish Required:** Y
Standard Cushions: High Resilency 40 **Standard Finish:** N/A
COL: 51 square feet
 Features an EasyClean Seat.

Laguna EasyClean Occasional Chair with Front Casters

Width: 24 **Depth:** 23 **Height:** 36.5
AH: 25.5 **SH:** 19.5 **SD:** 18 **IW:** 20.5
Weight: 35 / 40 lbs **Cube:** 11.65

1 2070	2 2145	3 2220	4 2295	5 2370	6 2445	8 3150	COL 1476	S Nail N/A	M Nail N/A
------------------	------------------	------------------	------------------	------------------	------------------	------------------	--------------------	----------------------	----------------------

L-8762-E4

Standard Pillows: N/A **Finish Required:** Y
Standard Cushions: High Resilency 40 **Standard Finish:** N/A
COL: 51 square feet
 Features an EasyClean Seat.

Laguna EasyClean Occasional Chair with Four Casters

Width: 24 **Depth:** 23 **Height:** 36.5
AH: 25.5 **SH:** 19.5 **SD:** 18 **IW:** 20.5
Weight: 35 / 40 lbs **Cube:** 11.65

1 2100	2 2175	3 2250	4 2325	5 2400	6 2475	8 3180	COL 1476	S Nail N/A	M Nail N/A
------------------	------------------	------------------	------------------	------------------	------------------	------------------	--------------------	----------------------	----------------------

L-8762-01

Standard Pillows: N/A **Finish Required:** Y
Standard Cushions: High Resilency 40 **Standard Finish:** N/A
COL: 51 square feet

Laguna Occasional Chair

Width: 24 **Depth:** 23 **Height:** 36.5
AH: 25.5 **SH:** 19.5 **SD:** 18 **IW:** 20.5
Weight: 35 / 40 lbs **Cube:** 11.65

1 1980	2 2055	3 2130	4 2205	5 2280	6 2355	8 3060	COL 1476	S Nail N/A	M Nail N/A
------------------	------------------	------------------	------------------	------------------	------------------	------------------	--------------------	----------------------	----------------------

LEATHER

L-8764-A2

Perkins Occasional Chair

Standard Pillows: N/A **Finish Required:** Y
Standard Cushions: High Resiliency 40 **Standard Finish:** N/A
COL: 59.5 square feet

Width: 26.5 **Depth:** 28.5 **Height:** 39.5
AH: 25.5 **SH:** 19.5 **SD:** 18.5 **IW:** 20
Weight: 35 / 40 lbs **Cube:** 17.26

1	2	3	4	5	6	8	COL	S Nail	M Nail
2505	2595	2685	2775	2865	2955	3780	1728	45	60

L-8764-E1

Perkins EasyClean Occasional Chair

Standard Pillows: N/A **Finish Required:** Y
Standard Cushions: High Resiliency 40 **Standard Finish:** N/A
COL: 59.5 square feet

Width: 26.5 **Depth:** 28.5 **Height:** 39.5
AH: 25.5 **SH:** 19.5 **SD:** 18.5 **IW:** 20
Weight: 35 / 40 lbs **Cube:** 17.26

1	2	3	4	5	6	8	COL	S Nail	M Nail
2505	2595	2685	2775	2865	2955	3780	1728	45	60

L-8764-E2

Perkins EasyClean Occasional Chair with Front Casters

Standard Pillows: N/A **Finish Required:** Y
Standard Cushions: High Resiliency 40 **Standard Finish:** N/A
COL: 59.5 square feet
 Features an EasyClean Seat.

Width: 26.5 **Depth:** 28.5 **Height:** 39.5
AH: 25.5 **SH:** 19.5 **SD:** 18.5 **IW:** 20
Weight: 35 / 40 lbs **Cube:** 17.26

1	2	3	4	5	6	8	COL	S Nail	M Nail
2535	2625	2715	2805	2895	2985	3810	1728	45	60

L-8764-01

Perkins Occasional Chair

Standard Pillows: N/A **Finish Required:** Y
Standard Cushions: High Resiliency 40 **Standard Finish:** N/A
COL: 59.5 square feet

Width: 26.5 **Depth:** 28.5 **Height:** 39.5
AH: 25.5 **SH:** 19.5 **SD:** 18.5 **IW:** 20
Weight: 35 / 40 lbs **Cube:** 17.26

1	2	3	4	5	6	8	COL	S Nail	M Nail
2475	2565	2655	2745	2835	2925	3750	1728	45	60

L-8766-A2

Alice Arm Chair

Standard Pillows: N/A **Finish Required:** Y
Standard Cushions: High Resiliency 40 **Standard Finish:** N/A
COL: 24.3 square feet

Width: 24.5 **Depth:** 23.5 **Height:** 39
AH: 26.5 **SH:** 19.5 **SD:** 18.5 **IW:** 21
Weight: 25 / 35 lbs **Cube:** 12.99

1	2	3	4	5	6	8	COL	S Nail	M Nail
1620	1665	1710	1755	1800	1845	2190	1290	N/A	N/A

L-8766-04

Alice Arm Chair

Standard Pillows: N/A **Finish Required:** Y
Standard Cushions: High Resiliency 40 **Standard Finish:** N/A
COL: 24.3 square feet

Width: 24.5 **Depth:** 23.5 **Height:** 39
AH: 26.5 **SH:** 19.5 **SD:** 18.5 **IW:** 21
Weight: 25 / 35 lbs **Cube:** 12.99

1	2	3	4	5	6	8	COL	S Nail	M Nail
1590	1635	1680	1725	1770	1815	2160	1290	N/A	N/A

L-8769-A2

Jennifer Arm Chair

Standard Pillows: N/A **Finish Required:** Y
Standard Cushions: High Resiliency 55 **Standard Finish:** N/A
COL: 34.2 square feet

Width: 24.5 **Depth:** 27 **Height:** 40
AH: 26.5 **SH:** 19 **SD:** 18.5 **IW:** 21
Weight: 35 / 40 lbs **Cube:** 15.31

1	2	3	4	5	6	8	COL	S Nail	M Nail
1755	1815	1875	1935	1995	2055	2535	1338	N/A	N/A

LEATHER

L-8769-A4

Standard Pillows: N/A **Finish Required:** Y
Standard Cushions: High Resilency 55 **Standard Finish:** N/A
COL: 34.2 square feet

Jennifer Arm Chair

Width: 24.5 **Depth:** 27 **Height:** 40
AH: 26.5 **SH:** 20 **SD:** 19 **IW:** 21
Weight: 35 / 40 lbs **Cube:** 15.31

1 1800	2 1860	3 1920	4 1980	5 2040	6 2100	8 2580	COL 1338	S Nail N/A	M Nail N/A
------------------	------------------	------------------	------------------	------------------	------------------	------------------	--------------------	----------------------	----------------------

L-8769-04

Standard Pillows: N/A **Finish Required:** Y
Standard Cushions: High Resilency 55 **Standard Finish:** N/A
COL: 34.2 square feet

Jennifer Arm Chair

Width: 24.5 **Depth:** 27 **Height:** 40
AH: 26.5 **SH:** 19 **SD:** 18.5 **IW:** 21
Weight: 30 / 35 lbs **Cube:** 15.31

1 1710	2 1770	3 1830	4 1890	5 1950	6 2010	8 2490	COL 1338	S Nail N/A	M Nail N/A
------------------	------------------	------------------	------------------	------------------	------------------	------------------	--------------------	----------------------	----------------------

L-8770-A2

Standard Pillows: N/A **Finish Required:** Y
Standard Cushions: High Resilency 40 **Standard Finish:** N/A
COL: 34.2 square feet

Laughlin Arm Chair

Width: 22 **Depth:** 23.5 **Height:** 36.5
AH: 26.5 **SH:** 20 **SD:** 18 **IW:** 20
Weight: 25 / 30 lbs **Cube:** 10.92

1 1695	2 1755	3 1815	4 1875	5 1935	6 1995	8 2475	COL 1173	S Nail N/A	M Nail N/A
------------------	------------------	------------------	------------------	------------------	------------------	------------------	--------------------	----------------------	----------------------

L-8770-04

Standard Pillows: N/A **Finish Required:** Y
Standard Cushions: High Resilency 40 **Standard Finish:** N/A
COL: 34.2 square feet

Laughlin Arm Chair

Width: 22 **Depth:** 23.5 **Height:** 36.5
AH: 26.5 **SH:** 18.5 **SD:** 18 **IW:** 20
Weight: 25 / 30 lbs **Cube:** 10.92

1 1665	2 1725	3 1785	4 1845	5 1905	6 1965	8 2445	COL 1173	S Nail N/A	M Nail N/A
------------------	------------------	------------------	------------------	------------------	------------------	------------------	--------------------	----------------------	----------------------

L-8771-A2

Standard Pillows: N/A **Finish Required:** Y
Standard Cushions: High Resilency 40 **Standard Finish:** N/A
COL: 34.2 square feet

Mapleton Arm Chair

Width: 22 **Depth:** 23 **Height:** 37
AH: 26.5 **SH:** 20 **SD:** 18 **IW:** 20
Weight: 25 / 30 lbs **Cube:** 10.83

1 1680	2 1740	3 1800	4 1860	5 1920	6 1980	8 2460	COL 1173	S Nail N/A	M Nail N/A
------------------	------------------	------------------	------------------	------------------	------------------	------------------	--------------------	----------------------	----------------------

L-8771-A4

Standard Pillows: N/A **Finish Required:** Y
Standard Cushions: High Resilency 40 **Standard Finish:** N/A
COL: 34.2 square feet

Mapleton Arm Chair

Width: 24 **Depth:** 23 **Height:** 37.5
AH: 26.5 **SH:** 18.5 **SD:** 18 **IW:** 20
Weight: 30 / 35 lbs **Cube:** 11.97

1 1725	2 1785	3 1845	4 1905	5 1965	6 2025	8 2505	COL 1173	S Nail N/A	M Nail N/A
------------------	------------------	------------------	------------------	------------------	------------------	------------------	--------------------	----------------------	----------------------

L-8771-04

Standard Pillows: N/A **Finish Required:** Y
Standard Cushions: High Resilency 40 **Standard Finish:** N/A
COL: 34.2 square feet

Mapleton Arm Chair

Width: 24 **Depth:** 23 **Height:** 37.5
AH: 26.5 **SH:** 18.5 **SD:** 18 **IW:** 20
Weight: 25 / 35 lbs **Cube:** 11.97

1 1650	2 1710	3 1770	4 1830	5 1890	6 1950	8 2430	COL 1173	S Nail N/A	M Nail N/A
------------------	------------------	------------------	------------------	------------------	------------------	------------------	--------------------	----------------------	----------------------

LEATHER

L-8772-A2

Standard Pillows: N/A **Finish Required:** Y
Standard Cushions: High Resiliency 40 **Standard Finish:** N/A
COL: 34.2 square feet

Naples Arm Chair

Width: 22.5 **Depth:** 24 **Height:** 33
AH: 25.5 **SH:** 19 **SD:** 19 **IW:** 19.5
Weight: 30 / 35 lbs **Cube:** 10.31

1 1725	2 1785	3 1845	4 1905	5 1965	6 2025	8 2505	COL 1290	S Nail 45	M Nail N/A
-----------	-----------	-----------	-----------	-----------	-----------	-----------	-------------	--------------	---------------

L-8772-A4

Standard Pillows: N/A **Finish Required:** Y
Standard Cushions: High Resiliency 40 **Standard Finish:** N/A
COL: 34.2 square feet

Naples Arm Chair

Width: 22.5 **Depth:** 24 **Height:** 33
AH: 25.5 **SH:** 19 **SD:** 19 **IW:** 19.5
Weight: 30 / 35 lbs **Cube:** 10.31

1 1770	2 1830	3 1890	4 1950	5 2010	6 2070	8 2550	COL 1290	S Nail 45	M Nail N/A
-----------	-----------	-----------	-----------	-----------	-----------	-----------	-------------	--------------	---------------

L-8772-04

Standard Pillows: N/A **Finish Required:** Y
Standard Cushions: High Resiliency 40 **Standard Finish:** N/A
COL: 34.2 square feet

Naples Arm Chair

Width: 22.5 **Depth:** 24 **Height:** 33
AH: 25.5 **SH:** 19 **SD:** 19 **IW:** 19.5
Weight: 30 / 35 lbs **Cube:** 10.31

1 1695	2 1755	3 1815	4 1875	5 1935	6 1995	8 2475	COL 1290	S Nail 45	M Nail N/A
-----------	-----------	-----------	-----------	-----------	-----------	-----------	-------------	--------------	---------------

L-8773-04

Standard Pillows: N/A **Finish Required:** Y
Standard Cushions: High Resiliency 40 **Standard Finish:** N/A
COL: 90.95 square feet

Carla Arm Chair

Width: 24.5 **Depth:** 29 **Height:** 44
AH: 24 **SH:** 21 **SD:** 18.5 **IW:** 19
Weight: 40 / 53 lbs **Cube:** 18.09

1 2775	2 2910	3 3045	4 3180	5 3315	6 3450	8 4710	COL 1710	S Nail 60	M Nail 75
-----------	-----------	-----------	-----------	-----------	-----------	-----------	-------------	--------------	--------------

L-8773-05

Standard Pillows: N/A **Finish Required:** Y
Standard Cushions: High Resiliency 40 **Standard Finish:** N/A
COL: 77.35 square feet

Carla Side Chair

Width: 21 **Depth:** 29.5 **Height:** 44.5
AH: - **SH:** 20 **SD:** 18 **IW:** 20
Weight: 30 / 45 lbs **Cube:** 15.95

1 2475	2 2595	3 2715	4 2835	5 2955	6 3075	8 4140	COL 1605	S Nail 60	M Nail 75
-----------	-----------	-----------	-----------	-----------	-----------	-----------	-------------	--------------	--------------

L-8778-A2

Standard Pillows: N/A **Finish Required:** Y
Standard Cushions: High Resiliency 40 **Standard Finish:** N/A
COL: 34.2 square feet

Pryor Arm Chair

Width: 24.5 **Depth:** 24.5 **Height:** 38.5
AH: 26.5 **SH:** 19 **SD:** 18 **IW:** 19.5
Weight: 30 / 35 lbs **Cube:** 13.37

1 1770	2 1830	3 1890	4 1950	5 2010	6 2070	8 2550	COL 1338	S Nail N/A	M Nail N/A
-----------	-----------	-----------	-----------	-----------	-----------	-----------	-------------	---------------	---------------

L-8778-A4

Standard Pillows: N/A **Finish Required:** Y
Standard Cushions: High Resiliency 40 **Standard Finish:** N/A
COL: 34.2 square feet

Pryor Arm Chair

Width: 24.5 **Depth:** 24.5 **Height:** 38.5
AH: 26.5 **SH:** 19 **SD:** 18 **IW:** 19.5
Weight: 30 / 35 lbs **Cube:** 13.37

1 1815	2 1875	3 1935	4 1995	5 2055	6 2115	8 2595	COL 1338	S Nail N/A	M Nail N/A
-----------	-----------	-----------	-----------	-----------	-----------	-----------	-------------	---------------	---------------

LEATHER

L-8778-04

Pryor Arm Chair

Standard Pillows: N/A **Finish Required:** Y
Standard Cushions: High Resiliency 40 **Standard Finish:** N/A
COL: 34.2 square feet

Width: 24.5 **Depth:** 24.5 **Height:** 38.5
AH: 26.5 **SH:** 19 **SD:** 18 **IW:** 19.5
Weight: 30 / 35 lbs **Cube:** 13.37

1 1740	2 1800	3 1860	4 1920	5 1980	6 2040	8 2520	COL 1338	S Nail N/A	M Nail N/A
------------------	------------------	------------------	------------------	------------------	------------------	------------------	--------------------	----------------------	----------------------

L-8779-A2

Hughes Arm Chair

Standard Pillows: N/A **Finish Required:** Y
Standard Cushions: High Resiliency 40 **Standard Finish:** N/A
COL: 40 square feet

Width: 23 **Depth:** 24 **Height:** 39.5
AH: 27 **SH:** 20 **SD:** 17.5 **IW:** 20
Weight: 23 / 34 lbs **Cube:** 12.61

1 1770	2 1830	3 1890	4 1950	5 2010	6 2070	8 2625	COL 1338	S Nail 45	M Nail N/A
------------------	------------------	------------------	------------------	------------------	------------------	------------------	--------------------	---------------------	----------------------

L-8779-A4

Hughes Arm Chair

Standard Pillows: N/A **Finish Required:** Y
Standard Cushions: High Resiliency 40 **Standard Finish:** N/A
COL: 40 square feet

Width: 23 **Depth:** 24 **Height:** 39.5
AH: 27 **SH:** 20 **SD:** 17.5 **IW:** 20
Weight: 23 / 34 lbs **Cube:** 12.61

1 1815	2 1875	3 1935	4 1995	5 2055	6 2115	8 2670	COL 1338	S Nail 45	M Nail N/A
------------------	------------------	------------------	------------------	------------------	------------------	------------------	--------------------	---------------------	----------------------

L-8779-04

Hughes Arm Chair

Standard Pillows: N/A **Finish Required:** Y
Standard Cushions: High Resiliency 40 **Standard Finish:** N/A
COL: 40 square feet

Width: 23 **Depth:** 24 **Height:** 39.5
AH: 27 **SH:** 20 **SD:** 17.5 **IW:** 20
Weight: 22 / 33 lbs **Cube:** 12.61

1 1740	2 1800	3 1860	4 1920	5 1980	6 2040	8 2595	COL 1338	S Nail 45	M Nail N/A
------------------	------------------	------------------	------------------	------------------	------------------	------------------	--------------------	---------------------	----------------------

L-8780-A2

Oakland Arm Chair

Standard Pillows: N/A **Finish Required:** Y
Standard Cushions: High Resiliency 40 **Standard Finish:** N/A
COL: 34.2 square feet

Width: 23 **Depth:** 24 **Height:** 37.5
AH: 25.5 **SH:** 19 **SD:** 18 **IW:** 20.5
Weight: 30 / 35 lbs **Cube:** 11.97

1 1860	2 1920	3 1980	4 2040	5 2100	6 2160	8 2640	COL 1413	S Nail 45	M Nail N/A
------------------	------------------	------------------	------------------	------------------	------------------	------------------	--------------------	---------------------	----------------------

L-8780-A4

Oakland Arm Chair

Standard Pillows: N/A **Finish Required:** Y
Standard Cushions: High Resiliency 40 **Standard Finish:** N/A
COL: 34.2 square feet

Width: 23 **Depth:** 24 **Height:** 37.5
AH: 25.5 **SH:** 19 **SD:** 18 **IW:** 20.5
Weight: 31 / 41 lbs **Cube:** 11.97

1 1920	2 1980	3 2040	4 2100	5 2160	6 2220	8 2700	COL 1413	S Nail 45	M Nail N/A
------------------	------------------	------------------	------------------	------------------	------------------	------------------	--------------------	---------------------	----------------------

L-8780-04

Oakland Arm Chair

Standard Pillows: N/A **Finish Required:** Y
Standard Cushions: High Resiliency 40 **Standard Finish:** N/A
COL: 34.2 square feet

Width: 23 **Depth:** 24 **Height:** 37.5
AH: 25.5 **SH:** 19 **SD:** 18 **IW:** 20.5
Weight: 30 / 35 lbs **Cube:** 11.97

1 1830	2 1890	3 1950	4 2010	5 2070	6 2130	8 2610	COL 1413	S Nail 45	M Nail N/A
------------------	------------------	------------------	------------------	------------------	------------------	------------------	--------------------	---------------------	----------------------

LEATHER

L-8783-11

Oakridge Arm Stack Chair

Standard Pillows: N/A **Finish Required:** Y
Standard Cushions: High Resilency 40 **Standard Finish:** N/A
COL: 34.2 square feet
 Available in FairShield Plus Finishes Only.Warranted for stacking three high.

Width: 23 **Depth:** 24 **Height:** 37.5
AH: 25.5 **SH:** 19 **SD:** 18.5 **IW:** 20
Weight: 30 / 35 lbs **Cube:** 11.97

1 1650	2 1710	3 1770	4 1830	5 1890	6 1950	8 2430	COL 1278	S Nail N/A	M Nail N/A
------------------	------------------	------------------	------------------	------------------	------------------	------------------	--------------------	----------------------	----------------------

L-8784-A2

Hayley Arm Chair

Standard Pillows: N/A **Finish Required:** Y
Standard Cushions: High Resilency 40 **Standard Finish:** N/A
COL: 72 square feet

Width: 27 **Depth:** 24.5 **Height:** 30.5
AH: 25 **SH:** 19.5 **SD:** 20 **IW:** 19
Weight: 35 / 40 lbs **Cube:** 11.67

1 3060	2 3180	3 3300	4 3420	5 3540	6 3660	8 4650	COL 2106	S Nail 75	M Nail 90
------------------	------------------	------------------	------------------	------------------	------------------	------------------	--------------------	---------------------	---------------------

L-8784-A4

Hayley Arm Chair

Standard Pillows: N/A **Finish Required:** Y
Standard Cushions: High Resilency 40 **Standard Finish:** N/A
COL: 72 square feet

Width: 27 **Depth:** 24.5 **Height:** 30.5
AH: 25 **SH:** 19.5 **SD:** 20 **IW:** 19
Weight: 35 / 40 lbs **Cube:** 11.67

1 3105	2 3225	3 3345	4 3465	5 3585	6 3705	8 4695	COL 2106	S Nail 75	M Nail 90
------------------	------------------	------------------	------------------	------------------	------------------	------------------	--------------------	---------------------	---------------------

L-8784-04

Hayley Arm Chair

Standard Pillows: N/A **Finish Required:** Y
Standard Cushions: High Resilency 40 **Standard Finish:** N/A
COL: 72 square feet

Width: 27 **Depth:** 24.5 **Height:** 30.5
AH: 25 **SH:** 19.5 **SD:** 20 **IW:** 19
Weight: 35 / 40 lbs **Cube:** 11.67

1 3030	2 3150	3 3270	4 3390	5 3510	6 3630	8 4620	COL 2106	S Nail 75	M Nail 90
------------------	------------------	------------------	------------------	------------------	------------------	------------------	--------------------	---------------------	---------------------

L-8784-1N

Hayley Task Chair

Standard Pillows: N/A **Finish Required:** N
Standard Cushions: High Resilency 40 **Standard Finish:** Nickel
COL: 72 square feet
 Features Swivel Nickel Base with Casters

Width: 27 **Depth:** 25.5 **Height:** 31.25
AH: 27.75 **SH:** 20.75 **SD:** 21.5 **IW:** 19
Weight: 41 / 54 lbs **Cube:** 12.45

1 3285	2 3405	3 3525	4 3645	5 3765	6 3885	8 4875	COL 2391	S Nail N/A	M Nail N/A
------------------	------------------	------------------	------------------	------------------	------------------	------------------	--------------------	----------------------	----------------------

L-8784-2N

Hayley Swivel Chair

Standard Pillows: N/A **Finish Required:** N
Standard Cushions: High Resilency 40 **Standard Finish:** Nickel
COL: 72 square feet
 Features Stationary Nickel Plated Base with a gas cylinder.

Width: 27 **Depth:** 25.5 **Height:** 28.75
AH: 26.25 **SH:** 19.25 **SD:** 21.5 **IW:** 19
Weight: 40 / 53 lbs **Cube:** 11.45

1 3285	2 3405	3 3525	4 3645	5 3765	6 3885	8 4875	COL 2391	S Nail N/A	M Nail N/A
------------------	------------------	------------------	------------------	------------------	------------------	------------------	--------------------	----------------------	----------------------

L-8788-A2

Oakwood Arm Chair

Standard Pillows: N/A **Finish Required:** Y
Standard Cushions: High Resilency 40 **Standard Finish:** N/A
COL: 34.2 square feet

Width: 23 **Depth:** 24 **Height:** 40
AH: 25.5 **SH:** 19 **SD:** 19 **IW:** 20
Weight: 30 / 35 lbs **Cube:** 12.77

1 1830	2 1890	3 1950	4 2010	5 2070	6 2130	8 2610	COL 1368	S Nail 45	M Nail N/A
------------------	------------------	------------------	------------------	------------------	------------------	------------------	--------------------	---------------------	----------------------

LEATHER

L-8788-A4

Standard Pillows: N/A **Finish Required:** Y
Standard Cushions: High Resiliency 40 **Standard Finish:** N/A
COL: 34.2 square feet

Oakwood Arm Chair

Width: 23 **Depth:** 24 **Height:** 40
AH: 25.5 **SH:** 19 **SD:** 19 **IW:** 20
Weight: 30 / 35 lbs **Cube:** 12.77

1 1875	2 1935	3 1995	4 2055	5 2115	6 2175	8 2655	COL 1368	S Nail 45	M Nail N/A
------------------	------------------	------------------	------------------	------------------	------------------	------------------	--------------------	---------------------	----------------------

L-8788-04

Standard Pillows: N/A **Finish Required:** Y
Standard Cushions: High Resiliency 40 **Standard Finish:** N/A
COL: 34.2 square feet

Oakwood Arm Chair

Width: 23 **Depth:** 24 **Height:** 37.5
AH: 25.5 **SH:** 19 **SD:** 19 **IW:** 20
Weight: 30 / 35 lbs **Cube:** 11.97

1 1800	2 1860	3 1920	4 1980	5 2040	6 2100	8 2580	COL 1368	S Nail 45	M Nail N/A
------------------	------------------	------------------	------------------	------------------	------------------	------------------	--------------------	---------------------	----------------------

L-8790-A2

Standard Pillows: N/A **Finish Required:** Y
Standard Cushions: High Resiliency 40 **Standard Finish:** N/A
COL: 34 square feet

Hopkins Arm Chair

Width: 24 **Depth:** 25.5 **Height:** 38
AH: 26 **SH:** 19 **SD:** 19 **IW:** 20
Weight: 35 / 40 lbs **Cube:** 13.45

1 1815	2 1875	3 1935	4 1995	5 2055	6 2115	8 2580	COL 1338	S Nail 45	M Nail 60
------------------	------------------	------------------	------------------	------------------	------------------	------------------	--------------------	---------------------	---------------------

L-8790-A4

Standard Pillows: N/A **Finish Required:** Y
Standard Cushions: High Resiliency 40 **Standard Finish:** N/A
COL: 34 square feet

Hopkins Arm Chair

Width: 24 **Depth:** 25.5 **Height:** 38
AH: 26 **SH:** 19 **SD:** 19 **IW:** 20
Weight: 35 / 40 lbs **Cube:** 13.45

1 1860	2 1920	3 1980	4 2040	5 2100	6 2160	8 2625	COL 1338	S Nail 45	M Nail 60
------------------	------------------	------------------	------------------	------------------	------------------	------------------	--------------------	---------------------	---------------------

L-8790-04

Standard Pillows: N/A **Finish Required:** Y
Standard Cushions: High Resiliency 40 **Standard Finish:** N/A
COL: 34 square feet

Hopkins Arm Chair

Width: 24 **Depth:** 25.5 **Height:** 38
AH: 26 **SH:** 19 **SD:** 19 **IW:** 20
Weight: 35 / 40 lbs **Cube:** 13.45

1 1785	2 1845	3 1905	4 1965	5 2025	6 2085	8 2550	COL 1338	S Nail 45	M Nail 60
------------------	------------------	------------------	------------------	------------------	------------------	------------------	--------------------	---------------------	---------------------

L-8794-A2

Standard Pillows: N/A **Finish Required:** Y
Standard Cushions: High Resiliency 55 **Standard Finish:** N/A
COL: 51 square feet

Bryant Arm Chair

Width: 24 **Depth:** 23 **Height:** 32
AH: 27 **SH:** 19.5 **SD:** 19 **IW:** 17.5
Weight: 27 / 37 lbs **Cube:** 10.22

1 2505	2 2580	3 2655	4 2730	5 2805	6 2880	8 3585	COL 1752	S Nail 75	M Nail N/A
------------------	------------------	------------------	------------------	------------------	------------------	------------------	--------------------	---------------------	----------------------

L-8794-BB

Standard Pillows: N/A **Finish Required:** Y
Standard Cushions: High Resiliency 55 **Standard Finish:** N/A
COL: 72 square feet

Bryant Bar Bench

Width: 56.25 **Depth:** 23 **Height:** 42
AH: 37 **SH:** 30 **SD:** 19 **IW:** 50
Weight: 50 / 75 lbs **Cube:** 31.44

1 3600	2 3720	3 3840	4 3960	5 4080	6 4200	8 5190	COL 2763	S Nail 120	M Nail N/A
------------------	------------------	------------------	------------------	------------------	------------------	------------------	--------------------	----------------------	----------------------

LEATHER

L-8794-CB

Bryant Counter Bench

Standard Pillows: N/A **Finish Required:** Y
Standard Cushions: High Resilency 55 **Standard Finish:** N/A
COL: 72 square feet

Width: 56.25 **Depth:** 23 **Height:** 38
AH: 33 **SH:** 26 **SD:** 19 **IW:** 50
Weight: 40 / 60 lbs **Cube:** 28.45

1 3600	2 3720	3 3840	4 3960	5 4080	6 4200	8 5190	COL 2763	S Nail 120	M Nail N/A
-----------	-----------	-----------	-----------	-----------	-----------	-----------	-------------	---------------	---------------

L-8794-C6

Bryant Counter Stool

Standard Pillows: N/A **Finish Required:** Y
Standard Cushions: High Resilency 55 **Standard Finish:** N/A
COL: 53.1 square feet

Width: 24 **Depth:** 23 **Height:** 38
AH: 33 **SH:** 26 **SD:** 19 **IW:** 17.5
Weight: 30 / 35 lbs **Cube:** 12.13

1 2625	2 2715	3 2805	4 2895	5 2985	6 3075	8 3810	COL 1857	S Nail 75	M Nail N/A
-----------	-----------	-----------	-----------	-----------	-----------	-----------	-------------	--------------	---------------

L-8794-M6

Bryant Multi-Height Bar Stool

Standard Pillows: N/A **Finish Required:** N
Standard Cushions: High Resilency 55 **Standard Finish:** Nickel
COL: 53.1 square feet

Width: 24 **Depth:** 23 **Height:** 38.5
AH: - **SH:** - **SD:** 19 **IW:** 17.5
Weight: 43 / 53 lbs **Cube:** 12.29

1 3285	2 3375	3 3465	4 3555	5 3645	6 3735	8 4470	COL 2622	S Nail 75	M Nail N/A
-----------	-----------	-----------	-----------	-----------	-----------	-----------	-------------	--------------	---------------

L-8794-04

Bryant Arm Chair

Standard Pillows: N/A **Finish Required:** Y
Standard Cushions: High Resilency 55 **Standard Finish:** N/A
COL: 51 square feet

Width: 24 **Depth:** 23 **Height:** 32
AH: 27 **SH:** 19.5 **SD:** 19 **IW:** 17.5
Weight: 25 / 35 lbs **Cube:** 10.22

1 2475	2 2550	3 2625	4 2700	5 2775	6 2850	8 3555	COL 1752	S Nail 75	M Nail N/A
-----------	-----------	-----------	-----------	-----------	-----------	-----------	-------------	--------------	---------------

L-8794-06

Bryant Bar Stool

Standard Pillows: N/A **Finish Required:** Y
Standard Cushions: High Resilency 55 **Standard Finish:** N/A
COL: 53.1 square feet

Width: 24 **Depth:** 23 **Height:** 42
AH: 37 **SH:** 30 **SD:** 19 **IW:** 17.5
Weight: 35 / 45 lbs **Cube:** 13.41

1 2625	2 2715	3 2805	4 2895	5 2985	6 3075	8 3810	COL 1857	S Nail 75	M Nail N/A
-----------	-----------	-----------	-----------	-----------	-----------	-----------	-------------	--------------	---------------

L-8794-1N

Bryant Task Chair

Standard Pillows: N/A **Finish Required:** N
Standard Cushions: High Resilency 55 **Standard Finish:** Nickel
COL: 53.1 square feet
 Features Swivel Nickel Base with Casters

Width: 24 **Depth:** 24 **Height:** 31.5
AH: 27.5 **SH:** 20.5 **SD:** 19 **IW:** 17.5
Weight: 40 / 50 lbs **Cube:** 10.5

1 2730	2 2820	3 2910	4 3000	5 3090	6 3180	8 3915	COL 1962	S Nail 75	M Nail N/A
-----------	-----------	-----------	-----------	-----------	-----------	-----------	-------------	--------------	---------------

L-8794-2N

Bryant Swivel Chair

Standard Pillows: N/A **Finish Required:** N
Standard Cushions: High Resilency 55 **Standard Finish:** Nickel
COL: 53.1 square feet
 Features Stationary Nickel Plated Base with a gas cylinder.

Width: 24 **Depth:** 24 **Height:** 30
AH: 26 **SH:** 19 **SD:** 19 **IW:** 17.5
Weight: 40 / 50 lbs **Cube:** 10

1 2730	2 2820	3 2910	4 3000	5 3090	6 3180	8 3915	COL 1962	S Nail 75	M Nail N/A
-----------	-----------	-----------	-----------	-----------	-----------	-----------	-------------	--------------	---------------

LEATHER

L-8795-E1

Atkinson EasyClean Occasional Chair

Standard Pillows: N/A **Finish Required:** Y
Standard Cushions: High Resiliency 40 **Standard Finish:** N/A
COL: 74 square feet
 Features an EasyClean Seat

Width: 26 **Depth:** 28 **Height:** 39.5
AH: 26 **SH:** 19.5 **SD:** 18 **IW:** 19
Weight: 36 / 49 lbs **Cube:** 16.64

1	2	3	4	5	6	8	COL	S Nail	M Nail
2520	2640	2760	2880	3000	3120	4140	1728	45	60

L-8796-A2

Gates Arm Chair

Standard Pillows: N/A **Finish Required:** Y
Standard Cushions: High Resiliency 40 **Standard Finish:** N/A
COL: 34.2 square feet

Width: 23 **Depth:** 24 **Height:** 34.5
AH: 25 **SH:** 20 **SD:** 19.5 **IW:** 19.5
Weight: 26 / 36 lbs **Cube:** 11.02

1	2	3	4	5	6	8	COL	S Nail	M Nail
1860	1920	1980	2040	2100	2160	2640	1470	N/A	N/A

L-8796-04

Gates Arm Chair

Standard Pillows: N/A **Finish Required:** Y
Standard Cushions: High Resiliency 40 **Standard Finish:** N/A
COL: 34.2 square feet

Width: 23 **Depth:** 24 **Height:** 34.5
AH: 25 **SH:** 20 **SD:** 19.5 **IW:** 19.5
Weight: 25 / 35 lbs **Cube:** 11.02

1	2	3	4	5	6	8	COL	S Nail	M Nail
1830	1890	1950	2010	2070	2130	2610	1470	N/A	N/A

L-8801-A2

Stella Arm Chair

Standard Pillows: N/A **Finish Required:** Y
Standard Cushions: High Resiliency 40 **Standard Finish:** N/A
COL: 45 square feet
 Standard with 2 front casters

Width: 24.25 **Depth:** 28 **Height:** 38.5
AH: 25 **SH:** 19.75 **SD:** 18.5 **IW:** 20.25
Weight: 23 / 33 lbs **Cube:** 15.12

1	2	3	4	5	6	8	COL	S Nail	M Nail
2055	2130	2205	2280	2355	2430	3060	1494	45	N/A

L-8801-A4

Stella Arm Chair

Standard Pillows: N/A **Finish Required:** Y
Standard Cushions: High Resiliency 40 **Standard Finish:** N/A
COL: 45 square feet
 Standard with casters on all legs

Width: 24.25 **Depth:** 28 **Height:** 38.5
AH: 25 **SH:** 19.75 **SD:** 18.5 **IW:** 20.25
Weight: 23 / 33 lbs **Cube:** 15.12

1	2	3	4	5	6	8	COL	S Nail	M Nail
2130	2205	2280	2355	2430	2505	3135	1494	45	N/A

L-8801-04

Stella Arm Chair

Standard Pillows: N/A **Finish Required:** Y
Standard Cushions: High Resiliency 40 **Standard Finish:** N/A
COL: 45 square feet

Width: 24.25 **Depth:** 28 **Height:** 38.5
AH: 25 **SH:** 19.75 **SD:** 18.5 **IW:** 20.25
Weight: 23 / 33 lbs **Cube:** 15.74

1	2	3	4	5	6	8	COL	S Nail	M Nail
2010	2085	2160	2235	2310	2385	3015	1494	45	N/A

L-8810-A2

Walsh Arm Chair

Standard Pillows: N/A **Finish Required:** Y
Standard Cushions: High Resiliency 40 **Standard Finish:** N/A
COL: 40 square feet

Width: 23.5 **Depth:** 26 **Height:** 40
AH: 25 **SH:** 19 **SD:** 19 **IW:** 20
Weight: 23 / 36 lbs **Cube:** 14.14

1	2	3	4	5	6	8	COL	S Nail	M Nail
1740	1800	1860	1920	1980	2040	2595	1350	N/A	N/A

LEATHER

L-8810-04

Walsh Arm Chair

Standard Pillows: N/A **Finish Required:** Y
Standard Cushions: High Resiliency 40 **Standard Finish:** N/A
COL: 40 square feet

Width: 23.5 **Depth:** 26 **Height:** 40
AH: 25 **SH:** 19 **SD:** 19 **IW:** 20
Weight: 23 / 34 lbs **Cube:** 14.14

1	2	3	4	5	6	8	COL	S Nail	M Nail
1710	1770	1830	1890	1950	2010	2565	1350	N/A	N/A

L-8810-05

Walsh Side Chair

Standard Pillows: N/A **Finish Required:** Y
Standard Cushions: High Resiliency 40 **Standard Finish:** N/A
COL: 34 square feet

Width: 22.75 **Depth:** 24 **Height:** 40
AH: - **SH:** 19.25 **SD:** 19 **IW:** 22.5
Weight: 20 / 31 lbs **Cube:** 12.63

1	2	3	4	5	6	8	COL	S Nail	M Nail
1665	1725	1785	1845	1905	1965	2430	1320	N/A	N/A

L-8812-05

Barkley Side Chair

Standard Pillows: N/A **Finish Required:** Y
Standard Cushions: High Resiliency 40 **Standard Finish:** N/A
COL: 34.2 square feet

Width: 23 **Depth:** 23 **Height:** 38.5
AH: - **SH:** 20 **SD:** 18.25 **IW:** 23
Weight: 19 / 29 lbs **Cube:** 11.78

1	2	3	4	5	6	8	COL	S Nail	M Nail
1755	1815	1875	1935	1995	2055	2535	1353	45	60

L-8814-05

Jacqueline Side Chair

Standard Pillows: N/A **Finish Required:** Y
Standard Cushions: High Resiliency 40 **Standard Finish:** N/A
COL: 51 square feet

Width: 19.5 **Depth:** 25.5 **Height:** 37
AH: - **SH:** 19 **SD:** 19 **IW:** 19.5
Weight: 17 / 27 lbs **Cube:** 10.64

1	2	3	4	5	6	8	COL	S Nail	M Nail
1890	1965	2040	2115	2190	2265	2970	1212	45	N/A

L-8815-05

Bryce Side Chair

Standard Pillows: N/A **Finish Required:** Y
Standard Cushions: High Resiliency 40 **Standard Finish:** N/A
COL: 57 square feet

Width: 21.5 **Depth:** 25.5 **Height:** 40
AH: - **SH:** 19 **SD:** 19 **IW:** 21.5
Weight: 18 / 28 lbs **Cube:** 12.69

1	2	3	4	5	6	8	COL	S Nail	M Nail
1890	1980	2070	2160	2250	2340	3135	1212	45	N/A

L-8817-05

Lucy Side Chair

Standard Pillows: N/A **Finish Required:** Y
Standard Cushions: High Resiliency 40 **Standard Finish:** N/A
COL: 45 square feet

Width: 21.5 **Depth:** 25.5 **Height:** 40
AH: - **SH:** 19 **SD:** 19 **IW:** 21.5
Weight: 18 / 28 lbs **Cube:** 12.69

1	2	3	4	5	6	8	COL	S Nail	M Nail
1890	1965	2040	2115	2190	2265	2895	1212	Std.	N/A

L-8818-04

Wilborn Arm Chair

Standard Pillows: N/A **Finish Required:** Y
Standard Cushions: High Resiliency 40 **Standard Finish:** N/A
COL: 34 square feet

Width: 23.5 **Depth:** 26.25 **Height:** 38.5
AH: 25 **SH:** 19 **SD:** 19.25 **IW:** 20.25
Weight: 21 / 31 lbs **Cube:** 13.74

1	2	3	4	5	6	8	COL	S Nail	M Nail
1710	1770	1830	1890	1950	2010	2475	1296	45	N/A

LEATHER

L-8819-A2

Kennedy Arm Chair

Standard Pillows: N/A **Finish Required:** Y
Standard Cushions: High Resiliency 40 **Standard Finish:** N/A
COL: 40 square feet

Width: 24 **Depth:** 25.5 **Height:** 38.25
AH: 25.5 **SH:** 19.5 **SD:** 19 **IW:** 20.25
Weight: 32 / 32 lbs **Cube:** 15.74

1 1770	2 1830	3 1890	4 1950	5 2010	6 2070	8 2625	COL 1350	S Nail 45	M Nail N/A
-----------	-----------	-----------	-----------	-----------	-----------	-----------	-------------	--------------	---------------

L-8819-A4

Kennedy Arm Chair

Standard Pillows: N/A **Finish Required:** Y
Standard Cushions: High Resiliency 40 **Standard Finish:** N/A
COL: 40 square feet

Width: 24 **Depth:** 25.5 **Height:** 38.25
AH: 25.5 **SH:** 19.5 **SD:** 19 **IW:** 20.25
Weight: 32 / 32 lbs **Cube:** 15.74

1 1815	2 1875	3 1935	4 1995	5 2055	6 2115	8 2670	COL 1350	S Nail 45	M Nail N/A
-----------	-----------	-----------	-----------	-----------	-----------	-----------	-------------	--------------	---------------

L-8819-04

Kennedy Arm Chair

Standard Pillows: N/A **Finish Required:** Y
Standard Cushions: High Resiliency 40 **Standard Finish:** N/A
COL: 40 square feet

Width: 24 **Depth:** 25.5 **Height:** 38.25
AH: 25.5 **SH:** 19.5 **SD:** 19 **IW:** 20.25
Weight: 32 / 32 lbs **Cube:** 15.74

1 1740	2 1800	3 1860	4 1920	5 1980	6 2040	8 2595	COL 1350	S Nail 45	M Nail N/A
-----------	-----------	-----------	-----------	-----------	-----------	-----------	-------------	--------------	---------------

L-8819-05

Kennedy Side Chair

Standard Pillows: N/A **Finish Required:** Y
Standard Cushions: High Resiliency 40 **Standard Finish:** N/A
COL: 38 square feet

Width: 24.5 **Depth:** 25.25 **Height:** 38.25
AH: - **SH:** 19.5 **SD:** 19 **IW:** 24.5
Weight: 30 / 30 lbs **Cube:** 13.69

1 1710	2 1770	3 1830	4 1890	5 1950	6 2010	8 2535	COL 1263	S Nail 45	M Nail N/A
-----------	-----------	-----------	-----------	-----------	-----------	-----------	-------------	--------------	---------------

L-8821-04

Clayton Arm Chair

Standard Pillows: N/A **Finish Required:** Y
Standard Cushions: High Resiliency 40 **Standard Finish:** N/A
COL: 40 square feet

Width: 24.5 **Depth:** 27.25 **Height:** 37.75
AH: 24.5 **SH:** 19.25 **SD:** 20 **IW:** 21
Weight: 22 / 33 lbs **Cube:** 14.58

1 1950	2 2010	3 2070	4 2130	5 2190	6 2250	8 2805	COL 1500	S Nail 45	M Nail N/A
-----------	-----------	-----------	-----------	-----------	-----------	-----------	-------------	--------------	---------------

L-8821-05

Clayton Side Chair

Standard Pillows: N/A **Finish Required:** Y
Standard Cushions: High Resiliency 40 **Standard Finish:** N/A
COL: 34.2 square feet

Width: 20 **Depth:** 27 **Height:** 38
AH: - **SH:** 19.5 **SD:** 20.25 **IW:** 20
Weight: 19 / 32 lbs **Cube:** 11.87

1 1920	2 1980	3 2040	4 2100	5 2160	6 2220	8 2700	COL 1470	S Nail 45	M Nail N/A
-----------	-----------	-----------	-----------	-----------	-----------	-----------	-------------	--------------	---------------

L-8822-04

Macey Arm Chair

Standard Pillows: N/A **Finish Required:** Y
Standard Cushions: High Resiliency 40 **Standard Finish:** N/A
COL: 51 square feet

Width: 25 **Depth:** 26 **Height:** 36.5
AH: 23.5 **SH:** 19.25 **SD:** 19 **IW:** 20
Weight: 31 / 41 lbs **Cube:** 13.72

1 2475	2 2550	3 2625	4 2700	5 2775	6 2850	8 3555	COL 1782	S Nail 45	M Nail N/A
-----------	-----------	-----------	-----------	-----------	-----------	-----------	-------------	--------------	---------------

LEATHER

L-8823-05

Standard Pillows: N/A **Finish Required:** Y
Standard Cushions: High Resiliency 40 **Standard Finish:** N/A
COL: 51 square feet

Josephine Side Chair

Width: 20 **Depth:** 25.5 **Height:** 40.25
AH: - **SH:** 19.5 **SD:** 19 **IW:** -
Weight: 17 / 28 lbs **Cube:** 11.87

1 1815	2 1890	3 1965	4 2040	5 2115	6 2190	8 2895	COL 1212	S Nail Std.	M Nail N/A
------------------	------------------	------------------	------------------	------------------	------------------	------------------	--------------------	-----------------------	----------------------

L-8833-04

Standard Pillows: N/A **Finish Required:** Y
Standard Cushions: High Resiliency 40 **Standard Finish:** N/A
COL: 40 square feet

Mcgee Arm Chair

Width: 25 **Depth:** 25.75 **Height:** 40.25
AH: 25 **SH:** 20 **SD:** 19.75 **IW:** 21.75
Weight: 20 / 31 lbs **Cube:** 14.99

1 1815	2 1875	3 1935	4 1995	5 2055	6 2115	8 2670	COL 1413	S Nail N/A	M Nail N/A
------------------	------------------	------------------	------------------	------------------	------------------	------------------	--------------------	----------------------	----------------------

L-8836-A2

Standard Pillows: N/A **Finish Required:** Y
Standard Cushions: High Resiliency 40 **Standard Finish:** N/A
COL: 34.2 square feet

Salida Arm Chair

Width: 23 **Depth:** 24.5 **Height:** 36
AH: 25.5 **SH:** 19 **SD:** 19.5 **IW:** 20
Weight: 25 / 35 lbs **Cube:** 11.73

1 1665	2 1725	3 1785	4 1845	5 1905	6 1965	8 2445	COL 1272	S Nail N/A	M Nail N/A
------------------	------------------	------------------	------------------	------------------	------------------	------------------	--------------------	----------------------	----------------------

L-8836-A4

Standard Pillows: N/A **Finish Required:** Y
Standard Cushions: High Resiliency 40 **Standard Finish:** N/A
COL: 34.2 square feet

Salida Arm Chair

Width: 23 **Depth:** 24.5 **Height:** 36
AH: 25.5 **SH:** 19 **SD:** 19.5 **IW:** 20
Weight: 25 / 35 lbs **Cube:** 11.73

1 1710	2 1770	3 1830	4 1890	5 1950	6 2010	8 2490	COL 1272	S Nail N/A	M Nail N/A
------------------	------------------	------------------	------------------	------------------	------------------	------------------	--------------------	----------------------	----------------------

L-8836-04

Standard Pillows: N/A **Finish Required:** Y
Standard Cushions: High Resiliency 40 **Standard Finish:** N/A
COL: 34.2 square feet

Salida Arm Chair

Width: 23.25 **Depth:** 24 **Height:** 36
AH: 25.75 **SH:** 19.5 **SD:** 20.5 **IW:** 19.75
Weight: 21 / 35 lbs **Cube:** 11.62

1 1635	2 1695	3 1755	4 1815	5 1875	6 1935	8 2415	COL 1272	S Nail N/A	M Nail N/A
------------------	------------------	------------------	------------------	------------------	------------------	------------------	--------------------	----------------------	----------------------

L-8836-05

Standard Pillows: N/A **Finish Required:** Y
Standard Cushions: High Resiliency 40 **Standard Finish:** N/A
COL: 29 square feet

Salida Side Chair

Width: 21.75 **Depth:** 25 **Height:** 36
AH: - **SH:** 20 **SD:** 19.5 **IW:** 21.75
Weight: 18 / 28 lbs **Cube:** 11.32

1 1605	2 1650	3 1695	4 1740	5 1785	6 1830	8 2235	COL 1212	S Nail N/A	M Nail N/A
------------------	------------------	------------------	------------------	------------------	------------------	------------------	--------------------	----------------------	----------------------

L-8837-05

Standard Pillows: N/A **Finish Required:** Y
Standard Cushions: High Resiliency 40 **Standard Finish:** N/A
COL: 34 square feet

Longmont Side Chair

Width: 23.25 **Depth:** 24.5 **Height:** 36.5
AH: - **SH:** 19 **SD:** 19 **IW:** 19.25
Weight: 25 / 38 lbs **Cube:** 12.03

1 1620	2 1680	3 1740	4 1800	5 1860	6 1920	8 2385	COL 1218	S Nail N/A	M Nail N/A
------------------	------------------	------------------	------------------	------------------	------------------	------------------	--------------------	----------------------	----------------------

LEATHER

L-8837-11

Standard Pillows: N/A **Finish Required:** Y
Standard Cushions: High Resilency 40 **Standard Finish:** N/A
COL: 34 square feet

Longmont Arm Stack Chair

Width: 23.25 **Depth:** 24.5 **Height:** 36.5
AH: 26.25 **SH:** 19 **SD:** 19 **IW:** 19.25
Weight: 25 / 35 lbs **Cube:** 12.03

1 1650	2 1710	3 1770	4 1830	5 1890	6 1950	8 2415	COL 1272	S Nail N/A	M Nail N/A
------------------	------------------	------------------	------------------	------------------	------------------	------------------	--------------------	----------------------	----------------------

L-8838-A2

Standard Pillows: N/A **Finish Required:** Y
Standard Cushions: High Resilency 40 **Standard Finish:** N/A
COL: 34 square feet

Loveland Arm Chair

Width: 23.25 **Depth:** 24.5 **Height:** 36.5
AH: 26.25 **SH:** 19 **SD:** 19 **IW:** 19.25
Weight: 25 / 35 lbs **Cube:** 12.03

1 1635	2 1695	3 1755	4 1815	5 1875	6 1935	8 2400	COL 1188	S Nail N/A	M Nail N/A
------------------	------------------	------------------	------------------	------------------	------------------	------------------	--------------------	----------------------	----------------------

L-8838-A4

Standard Pillows: N/A **Finish Required:** Y
Standard Cushions: High Resilency 40 **Standard Finish:** N/A
COL: 34 square feet

Loveland Arm Chair

Width: 23.25 **Depth:** 24.5 **Height:** 36.5
AH: 26.25 **SH:** 19 **SD:** 19 **IW:** 19.25
Weight: 25 / 25 lbs **Cube:** 12.03

1 1680	2 1740	3 1800	4 1860	5 1920	6 1980	8 2445	COL 1188	S Nail N/A	M Nail N/A
------------------	------------------	------------------	------------------	------------------	------------------	------------------	--------------------	----------------------	----------------------

L-8838-04

Standard Pillows: N/A **Finish Required:** Y
Standard Cushions: High Resilency 40 **Standard Finish:** N/A
COL: 34 square feet

Loveland Arm Chair

Width: 23.25 **Depth:** 24.5 **Height:** 36.5
AH: 26.25 **SH:** 19 **SD:** 19 **IW:** 19.25
Weight: 29 / 39 lbs **Cube:** 12.03

1 1605	2 1665	3 1725	4 1785	5 1845	6 1905	8 2370	COL 1188	S Nail N/A	M Nail N/A
------------------	------------------	------------------	------------------	------------------	------------------	------------------	--------------------	----------------------	----------------------

L-8839-A2

Standard Pillows: N/A **Finish Required:** Y
Standard Cushions: High Resilency 40 **Standard Finish:** N/A
COL: 29 square feet

Littleton Arm Chair

Width: 23.25 **Depth:** 24.75 **Height:** 37
AH: 25.75 **SH:** 19 **SD:** 19.5 **IW:** 19.75
Weight: 20 / 35 lbs **Cube:** 12.32

1 1650	2 1695	3 1740	4 1785	5 1830	6 1875	8 2280	COL 1188	S Nail 45	M Nail N/A
------------------	------------------	------------------	------------------	------------------	------------------	------------------	--------------------	---------------------	----------------------

L-8839-A4

Standard Pillows: N/A **Finish Required:** Y
Standard Cushions: High Resilency 40 **Standard Finish:** N/A
COL: 29 square feet

Littleton Arm Chair

Width: 23.25 **Depth:** 24.75 **Height:** 37
AH: 25.75 **SH:** 19 **SD:** 19.5 **IW:** 19.75
Weight: 20 / 35 lbs **Cube:** 12.32

1 1695	2 1740	3 1785	4 1830	5 1875	6 1920	8 2325	COL 1188	S Nail 45	M Nail N/A
------------------	------------------	------------------	------------------	------------------	------------------	------------------	--------------------	---------------------	----------------------

L-8839-04

Standard Pillows: N/A **Finish Required:** Y
Standard Cushions: High Resilency 40 **Standard Finish:** N/A
COL: 29 square feet

Littleton Arm Chair

Width: 23.25 **Depth:** 24.75 **Height:** 37
AH: 25.75 **SH:** 19 **SD:** 19.5 **IW:** 19.75
Weight: 20 / 35 lbs **Cube:** 12.32

1 1620	2 1665	3 1710	4 1755	5 1800	6 1845	8 2250	COL 1188	S Nail 45	M Nail N/A
------------------	------------------	------------------	------------------	------------------	------------------	------------------	--------------------	---------------------	----------------------

LEATHER

L-8839-05

Littleton Side Chair

Standard Pillows: N/A **Finish Required:** Y
Standard Cushions: High Resiliency 40 **Standard Finish:** N/A
COL: 29 square feet

Width: 21.75 **Depth:** 25 **Height:** 37
AH: - **SH:** 20 **SD:** 19.5 **IW:** 21.75
Weight: 18 / 28 lbs **Cube:** 11.64

1	2	3	4	5	6	8	COL	S Nail	M Nail
1590	1635	1680	1725	1770	1815	2220	1188	45	N/A

L-8840-04

Lila Arm Chair

Standard Pillows: N/A **Finish Required:** Y
Standard Cushions: High Resiliency 40 **Standard Finish:** N/A
COL: 34.2 square feet

Width: 22.25 **Depth:** 24.5 **Height:** 39
AH: 24.25 **SH:** 19 **SD:** 18.5 **IW:** 18.5
Weight: 19 / 29 lbs **Cube:** 12.3

1	2	3	4	5	6	8	COL	S Nail	M Nail
1815	1875	1935	1995	2055	2115	2595	1398	45	N/A

L-8840-05

Lila Side Chair

Standard Pillows: N/A **Finish Required:** Y
Standard Cushions: High Resiliency 40 **Standard Finish:** N/A
COL: 34 square feet

Width: 23.25 **Depth:** 24.5 **Height:** 39
AH: - **SH:** 19 **SD:** 18.5 **IW:** 23.75
Weight: 17 / 27 lbs **Cube:** 12.85

1	2	3	4	5	6	8	COL	S Nail	M Nail
1785	1845	1905	1965	2025	2085	2550	1368	45	N/A

L-8842-04

Ava Arm Chair

Standard Pillows: N/A **Finish Required:** Y
Standard Cushions: High Resiliency 40 **Standard Finish:** N/A
COL: 34.2 square feet
 Features natural cane accents that was handwoven using the peel of natural rattan. As with any natural product, nature's imperfections and hallmarks will be present in the cane materials. Cane is a handcrafted product dating back to the Ancient Egyptians.

Width: 22.5 **Depth:** 25.75 **Height:** 40.5
AH: 24.5 **SH:** 19.5 **SD:** 20 **IW:** 20
Weight: 16 / 27 lbs **Cube:** 13.57

1	2	3	4	5	6	8	COL	S Nail	M Nail
1740	1800	1860	1920	1980	2040	2520	1338	45	N/A

L-8842-05

Ava Side Chair

Standard Pillows: N/A **Finish Required:** Y
Standard Cushions: High Resiliency 40 **Standard Finish:** N/A
COL: 34.2 square feet
 Features natural cane accents that was handwoven using the peel of natural rattan. As with any natural product, nature's imperfections and hallmarks will be present in the cane materials. Cane is a handcrafted product dating back to the Ancient Egyptians.

Width: 22.5 **Depth:** 25.75 **Height:** 40.5
AH: 24.5 **SH:** 19.5 **SD:** 20 **IW:** 20
Weight: 16 / 27 lbs **Cube:** 13.57

1	2	3	4	5	6	8	COL	S Nail	M Nail
1710	1770	1830	1890	1950	2010	2490	1308	45	N/A

L-8845-A2

Turner Arm Chair

Standard Pillows: N/A **Finish Required:** Y
Standard Cushions: High Resiliency 40 **Standard Finish:** N/A
COL: 45 square feet

Width: 24.75 **Depth:** 29 **Height:** 40
AH: 25 **SH:** 19 **SD:** 19 **IW:** 21.75
Weight: 31 / 44 lbs **Cube:** 16.61

1	2	3	4	5	6	8	COL	S Nail	M Nail
2205	2280	2355	2430	2505	2580	3210	1662	N/A	N/A

L-8845-A4

Turner Arm Chair

Standard Pillows: N/A **Finish Required:** Y
Standard Cushions: High Resiliency 40 **Standard Finish:** N/A
COL: 45 square feet

Width: 24.75 **Depth:** 29 **Height:** 40
AH: 25 **SH:** 19 **SD:** 19 **IW:** 21.75
Weight: 31 / 45 lbs **Cube:** 16.61

1	2	3	4	5	6	8	COL	S Nail	M Nail
2250	2325	2400	2475	2550	2625	3255	1662	N/A	N/A

LEATHER

L-8845-04

Turner Arm Chair

Standard Pillows: N/A **Finish Required:** Y
Standard Cushions: High Resiliency 40 **Standard Finish:** N/A
COL: 45 square feet

Width: 24.75 **Depth:** 29 **Height:** 40
AH: 25 **SH:** 19 **SD:** 19 **IW:** 21.75
Weight: 31 / 48 lbs **Cube:** 16.61

1 2175	2 2250	3 2325	4 2400	5 2475	6 2550	8 3180	COL 1662	S Nail N/A	M Nail N/A
------------------	------------------	------------------	------------------	------------------	------------------	------------------	--------------------	----------------------	----------------------

L-8846-04

Larson Arm Chair

Standard Pillows: N/A **Finish Required:** Y
Standard Cushions: High Resiliency 40 **Standard Finish:** N/A
COL: 24.3 square feet
Features natural cane accents that was handwoven using the peel of natural rattan. As with any natural product, nature's imperfections and hallmarks will be present in the cane materials. Cane is a handcrafted product dating back to the Ancient Egyptians.

Width: 21.25 **Depth:** 24.5 **Height:** 34.75
AH: 25.25 **SH:** 20.5 **SD:** 20 **IW:** 19
Weight: 17 / 27 lbs **Cube:** 10.46

1 1485	2 1530	3 1575	4 1620	5 1665	6 1710	8 2055	COL 1188	S Nail N/A	M Nail N/A
------------------	------------------	------------------	------------------	------------------	------------------	------------------	--------------------	----------------------	----------------------

L-8846-05

Larson Side Chair

Standard Pillows: N/A **Finish Required:** Y
Standard Cushions: High Resiliency 40 **Standard Finish:** N/A
COL: 24.3 square feet
Features natural cane accents that was handwoven using the peel of natural rattan. As with any natural product, nature's imperfections and hallmarks will be present in the cane materials. Cane is a handcrafted product dating back to the Ancient Egyptians.

Width: 20 **Depth:** 24.5 **Height:** 34.75
AH: - **SH:** 20.5 **SD:** 20 **IW:** -
Weight: 16 / 26 lbs **Cube:** 9.85

1 1455	2 1500	3 1545	4 1590	5 1635	6 1680	8 2025	COL 1158	S Nail N/A	M Nail N/A
------------------	------------------	------------------	------------------	------------------	------------------	------------------	--------------------	----------------------	----------------------

L-8847-A2

Catherine Arm Chair

Standard Pillows: N/A **Finish Required:** Y
Standard Cushions: High Resiliency 40 **Standard Finish:** N/A
COL: 40 square feet

Width: 23.25 **Depth:** 24.5 **Height:** 37.75
AH: 25.25 **SH:** 19.25 **SD:** 19.25 **IW:** 19.25
Weight: 22 / 32 lbs **Cube:** 12.44

1 1845	2 1905	3 1965	4 2025	5 2085	6 2145	8 2700	COL 1368	S Nail 75	M Nail N/A
------------------	------------------	------------------	------------------	------------------	------------------	------------------	--------------------	---------------------	----------------------

L-8847-A4

Catherine Arm Chair

Standard Pillows: N/A **Finish Required:** Y
Standard Cushions: High Resiliency 40 **Standard Finish:** N/A
COL: 40 square feet

Width: 23.25 **Depth:** 24.5 **Height:** 37.75
AH: 25.25 **SH:** 19.25 **SD:** 19.25 **IW:** 19.25
Weight: 22 / 32 lbs **Cube:** 12.44

1 1890	2 1950	3 2010	4 2070	5 2130	6 2190	8 2745	COL 1368	S Nail 75	M Nail N/A
------------------	------------------	------------------	------------------	------------------	------------------	------------------	--------------------	---------------------	----------------------

L-8847-04

Catherine Arm Chair

Standard Pillows: N/A **Finish Required:** Y
Standard Cushions: High Resiliency 40 **Standard Finish:** N/A
COL: 40 square feet

Width: 23.25 **Depth:** 24.5 **Height:** 37.75
AH: 25.25 **SH:** 19.25 **SD:** 19.25 **IW:** 19.25
Weight: 22 / 32 lbs **Cube:** 12.44

1 1815	2 1875	3 1935	4 1995	5 2055	6 2115	8 2670	COL 1368	S Nail 75	M Nail N/A
------------------	------------------	------------------	------------------	------------------	------------------	------------------	--------------------	---------------------	----------------------

L-8849-A2

Rocco Arm Chair

Standard Pillows: N/A **Finish Required:** Y
Standard Cushions: High Resiliency 40 **Standard Finish:** N/A
COL: 40 square feet

Width: 22 **Depth:** 24.5 **Height:** 35.5
AH: 25 **SH:** 20.25 **SD:** 19 **IW:** 19.75
Weight: 32 / 32 lbs **Cube:** 11.07

1 1860	2 1920	3 1980	4 2040	5 2100	6 2160	8 2715	COL 1368	S Nail N/A	M Nail N/A
------------------	------------------	------------------	------------------	------------------	------------------	------------------	--------------------	----------------------	----------------------

LEATHER

L-8849-A4

Standard Pillows: N/A **Finish Required:** Y
Standard Cushions: High Resiliency 40 **Standard Finish:** N/A
COL: 40 square feet

Rocco Arm Chair

Width: 22 **Depth:** 24.5 **Height:** 35.5
AH: 25 **SH:** 20.25 **SD:** 19 **IW:** 19.75
Weight: 32 / 32 lbs **Cube:** 11.07

1 1905	2 1965	3 2025	4 2085	5 2145	6 2205	8 2760	COL 1368	S Nail N/A	M Nail N/A
------------------	------------------	------------------	------------------	------------------	------------------	------------------	--------------------	----------------------	----------------------

L-8849-C6

PELLE PROVISIONS

Rocco Counter Stool

Standard Pillows: N/A **Finish Required:** Y
Standard Cushions: High Resiliency 40 **Standard Finish:** N/A
COL: 29 square feet

Width: 21.25 **Depth:** 24 **Height:** 40.5
AH: 32 **SH:** 26.5 **SD:** 19 **IW:** 21.25
Weight: 25 / 35 lbs **Cube:** 17.77

1 2070	2 2115	3 2160	4 2205	5 2250	6 2295	8 2700	COL 1698	S Nail N/A	M Nail N/A
------------------	------------------	------------------	------------------	------------------	------------------	------------------	--------------------	----------------------	----------------------

L-8849-C7

PELLE PROVISIONS

Rocco Counter Stool

Standard Pillows: N/A **Finish Required:** Y
Standard Cushions: High Resiliency 40 **Standard Finish:** N/A
COL: 29 square feet

Width: 21.25 **Depth:** 24 **Height:** 40.5
AH: - **SH:** 26.5 **SD:** 19 **IW:** 21.25
Weight: 23 / 33 lbs **Cube:** 17.77

1 2025	2 2070	3 2115	4 2160	5 2205	6 2250	8 2655	COL 1638	S Nail N/A	M Nail N/A
------------------	------------------	------------------	------------------	------------------	------------------	------------------	--------------------	----------------------	----------------------

L-8849-04

PELLE PROVISIONS

Rocco Arm Chair

Standard Pillows: N/A **Finish Required:** Y
Standard Cushions: High Resiliency 40 **Standard Finish:** N/A
COL: 40 square feet

Width: 22 **Depth:** 24.5 **Height:** 35.5
AH: 25 **SH:** 20.25 **SD:** 19 **IW:** 19.75
Weight: 32 / 32 lbs **Cube:** 11.07

1 1830	2 1890	3 1950	4 2010	5 2070	6 2130	8 2685	COL 1368	S Nail N/A	M Nail N/A
------------------	------------------	------------------	------------------	------------------	------------------	------------------	--------------------	----------------------	----------------------

L-8849-05

Rocco Dining Chair

Leather

Standard Pillows: N/A **Finish Required:** Y
Standard Cushions: High Resiliency 40 **Standard Finish:** N/A
COL: 40 square feet
 Features a hidden handle

Width: 20.75 **Depth:** 24.5 **Height:** 35.25
AH: - **SH:** 20 **SD:** 18.75 **IW:** 20.75
Weight: 21 / 21 lbs **Cube:** 10.37

1 1785	2 1845	3 1905	4 1965	5 2025	6 2085	8 2640	COL 1323	S Nail N/A	M Nail N/A
------------------	------------------	------------------	------------------	------------------	------------------	------------------	--------------------	----------------------	----------------------

L-8849-06

PELLE PROVISIONS

Rocco Bar Stool

Standard Pillows: N/A **Finish Required:** Y
Standard Cushions: High Resiliency 40 **Standard Finish:** N/A
COL: 29 square feet

Width: 21.25 **Depth:** 24 **Height:** 44.5
AH: 36 **SH:** 30.5 **SD:** 19 **IW:** 21.25
Weight: 25 / 38 lbs **Cube:** 19.6

1 2070	2 2115	3 2160	4 2205	5 2250	6 2295	8 2700	COL 1698	S Nail N/A	M Nail N/A
------------------	------------------	------------------	------------------	------------------	------------------	------------------	--------------------	----------------------	----------------------

L-8849-07

PELLE PROVISIONS

Rocco Bar Stool

Standard Pillows: N/A **Finish Required:** Y
Standard Cushions: High Resiliency 40 **Standard Finish:** N/A
COL: 29 square feet

Width: 21.25 **Depth:** 24 **Height:** 44.5
AH: - **SH:** 30.5 **SD:** 19 **IW:** 21.25
Weight: 23 / 36 lbs **Cube:** 19.6

1 2025	2 2070	3 2115	4 2160	5 2205	6 2250	8 2655	COL 1638	S Nail N/A	M Nail N/A
------------------	------------------	------------------	------------------	------------------	------------------	------------------	--------------------	----------------------	----------------------

LEATHER

L-8850-A2

Apollo Arm Chair

Width: 23.25 Depth: 25 Height: 37.25
 AH: 25 SH: 20 SD: 19 IW: 20.25
 Weight: 30 / 30 lbs Cube: 15.74

Standard Pillows: N/A Finish Required: Y
 Standard Cushions: High Resiliency 40 Standard Finish: N/A
 COL: 40 square feet
 Features a notched opening at the top back edge which provides a convenient holding spot.

1	2	3	4	5	6	8	COL	S Nail	M Nail
1920	1980	2040	2100	2160	2220	2775	1410	N/A	N/A

L-8850-A4

Apollo Arm Chair

Width: 23.25 Depth: 25 Height: 37.25
 AH: 25 SH: 20 SD: 19 IW: 20.25
 Weight: 30 / 30 lbs Cube: 15.74

Standard Pillows: N/A Finish Required: Y
 Standard Cushions: High Resiliency 40 Standard Finish: N/A
 COL: 40 square feet

1	2	3	4	5	6	8	COL	S Nail	M Nail
1965	2025	2085	2145	2205	2265	2820	1410	N/A	N/A

L-8850-04

PELLE PROVISIONS Apollo Arm Chair

Width: 23.25 Depth: 25 Height: 37.25
 AH: 25 SH: 20 SD: 19 IW: 20.25
 Weight: 30 / 30 lbs Cube: 15.74

Standard Pillows: N/A Finish Required: Y
 Standard Cushions: High Resiliency 40 Standard Finish: N/A
 COL: 40 square feet
 Features a notched opening at the top back edge which provides a convenient holding spot.

1	2	3	4	5	6	8	COL	S Nail	M Nail
1890	1950	2010	2070	2130	2190	2745	1410	N/A	N/A

L-8851-A2

Big Sur Arm Chair

Width: 24 Depth: 27 Height: 37.5
 AH: 25.25 SH: 20 SD: 21 IW: 20.25
 Weight: 36 / 33 lbs Cube: 15.74

Standard Pillows: N/A Finish Required: Y
 Standard Cushions: High Resiliency 40 Standard Finish: N/A
 COL: 40 square feet

1	2	3	4	5	6	8	COL	S Nail	M Nail
1845	1905	1965	2025	2085	2145	2700	1368	N/A	N/A

L-8851-A4

Big Sur Arm Chair

Width: 24 Depth: 27 Height: 37.5
 AH: 25.25 SH: 20 SD: 21 IW: 20.25
 Weight: 36 / 33 lbs Cube: 15.74

Standard Pillows: N/A Finish Required: Y
 Standard Cushions: High Resiliency 40 Standard Finish: N/A
 COL: 40 square feet

1	2	3	4	5	6	8	COL	S Nail	M Nail
1890	1950	2010	2070	2130	2190	2745	1368	N/A	N/A

L-8851-04

PELLE PROVISIONS Big Sur Arm Chair

Width: 24 Depth: 27 Height: 37.5
 AH: 25.25 SH: 20 SD: 21 IW: 20.25
 Weight: 36 / 36 lbs Cube: 14.06

Standard Pillows: N/A Finish Required: Y
 Standard Cushions: High Resiliency 40 Standard Finish: N/A
 COL: 40 square feet

1	2	3	4	5	6	8	COL	S Nail	M Nail
1815	1875	1935	1995	2055	2115	2670	1368	N/A	N/A

L-8852-05

PELLE PROVISIONS Trenton Side Chair

Width: 22.5 Depth: 26.5 Height: 41.25
 AH: - SH: 19.5 SD: 18.5 IW: 19
 Weight: 21 / 31 lbs Cube: 15.74

Standard Pillows: N/A Finish Required: Y
 Standard Cushions: High Resiliency 40 Standard Finish: N/A
 COL: 62 square feet

1	2	3	4	5	6	8	COL	S Nail	M Nail
2475	2580	2685	2790	2895	3000	3855	1692	90	N/A

LEATHER

L-8852-05-2
PELLE PROVISIONS
Trenton Side Chair

Standard Pillows: N/A **Finish Required:** Y
Standard Cushions: High Resiliency 40 **Standard Finish:** N/A
COL: 62 square feet

Width: 22.5 **Depth:** 26.5 **Height:** 41.25
AH: - **SH:** 19.5 **SD:** 18.5 **IW:** 19
Weight: 32 / 43 lbs **Cube:** 17.77

1 2505	2 2610	3 2715	4 2820	5 2925	6 3030	8 3885	COL 1692	S Nail 90	M Nail N/A
------------------	------------------	------------------	------------------	------------------	------------------	------------------	--------------------	---------------------	----------------------

L-8852-05-6
PELLE PROVISIONS
Trenton Side Chair

Standard Pillows: N/A **Finish Required:** Y
Standard Cushions: High Resiliency 40 **Standard Finish:** N/A
COL: 62 square feet
Standard with a Brushed Brass Ring Pull.

Width: 22.5 **Depth:** 26.5 **Height:** 41.25
AH: - **SH:** 19.5 **SD:** 18.5 **IW:** 19
Weight: 32 / 43 lbs **Cube:** 17.77

1 2505	2 2610	3 2715	4 2820	5 2925	6 3030	8 3885	COL 1692	S Nail 90	M Nail N/A
------------------	------------------	------------------	------------------	------------------	------------------	------------------	--------------------	---------------------	----------------------

L-8853-A2
Reece Arm Chair

Standard Pillows: N/A **Finish Required:** Y
Standard Cushions: High Resiliency 40 **Standard Finish:** N/A
COL: 40 square feet
Standard with 2 front casters and features a notched opening at the top back edge which provides a convenient holding spot.

Width: 22.5 **Depth:** 25.5 **Height:** 37
AH: 25 **SH:** 20.5 **SD:** 20 **IW:** 19.5
Weight: 22 / 32 lbs **Cube:** 15.74

1 1875	2 1935	3 1995	4 2055	5 2115	6 2175	8 2730	COL 1398	S Nail N/A	M Nail N/A
------------------	------------------	------------------	------------------	------------------	------------------	------------------	--------------------	----------------------	----------------------

L-8853-A4
Reece Arm Chair

Standard Pillows: N/A **Finish Required:** Y
Standard Cushions: High Resiliency 40 **Standard Finish:** N/A
COL: 40 square feet
Standard with casters on all legs and features a notched opening at the top back edge which provides a convenient holding spot.

Width: 22.5 **Depth:** 25.5 **Height:** 37
AH: 25 **SH:** 20.5 **SD:** 20 **IW:** 19.5
Weight: 22 / 32 lbs **Cube:** 15.74

1 1920	2 1980	3 2040	4 2100	5 2160	6 2220	8 2775	COL 1398	S Nail N/A	M Nail N/A
------------------	------------------	------------------	------------------	------------------	------------------	------------------	--------------------	----------------------	----------------------

L-8853-C6
Reece Counter Stool

Standard Pillows: N/A **Finish Required:** Y
Standard Cushions: High Resiliency 40 **Standard Finish:** N/A
COL: 40 square feet
Features a notched opening at the top back edge which provides a convenient holding spot.

Width: 20.5 **Depth:** 23.25 **Height:** 44.25
AH: 32 **SH:** 27 **SD:** 16.75 **IW:** 16.5
Weight: 21 / 32 lbs **Cube:** 17.77

1 2055	2 2115	3 2175	4 2235	5 2295	6 2355	8 2910	COL 1632	S Nail N/A	M Nail N/A
------------------	------------------	------------------	------------------	------------------	------------------	------------------	--------------------	----------------------	----------------------

L-8853-04
Reece Arm Chair

Standard Pillows: N/A **Finish Required:** Y
Standard Cushions: High Resiliency 40 **Standard Finish:** N/A
COL: 40 square feet
Features a notched opening at the top back edge which provides a convenient holding spot.

Width: 22.5 **Depth:** 25.5 **Height:** 37
AH: 25 **SH:** 20.5 **SD:** 20 **IW:** 19.5
Weight: 22 / 32 lbs **Cube:** 15.74

1 1845	2 1905	3 1965	4 2025	5 2085	6 2145	8 2700	COL 1398	S Nail N/A	M Nail N/A
------------------	------------------	------------------	------------------	------------------	------------------	------------------	--------------------	----------------------	----------------------

L-8853-06
Reece Bar Stool

Standard Pillows: N/A **Finish Required:** Y
Standard Cushions: High Resiliency 40 **Standard Finish:** N/A
COL: 40 square feet
Features a notched opening at the top back edge which provides a convenient holding spot.

Width: 20.5 **Depth:** 23.25 **Height:** 48.25
AH: 36 **SH:** 31 **SD:** 16.75 **IW:** 16.5
Weight: 21 / 35 lbs **Cube:** 19.6

1 2055	2 2115	3 2175	4 2235	5 2295	6 2355	8 2910	COL 1632	S Nail N/A	M Nail N/A
------------------	------------------	------------------	------------------	------------------	------------------	------------------	--------------------	----------------------	----------------------

LEATHER

L-8854-A2

Cleo Arm Chair

Standard Pillows: N/A **Finish Required:** Y
Standard Cushions: High Resiliency 40 **Standard Finish:** N/A
COL: 68 square feet
 Standard with 2 front casters

Width: 22.5 **Depth:** 24.75 **Height:** 31.75
AH: 26 **SH:** 19.5 **SD:** 19.5 **IW:** 18
Weight: 30 / 40 lbs **Cube:** 10.23

1 2655	2 2760	3 2865	4 2970	5 3075	6 3180	8 4125	COL 1881	S Nail 75	M Nail 90
-----------	-----------	-----------	-----------	-----------	-----------	-----------	-------------	--------------	--------------

L-8854-A4

Cleo Arm Chair

Standard Pillows: N/A **Finish Required:** Y
Standard Cushions: High Resiliency 40 **Standard Finish:** N/A
COL: 68 square feet
 Standard with casters on all legs

Width: 22.5 **Depth:** 24.75 **Height:** 31.75
AH: 26 **SH:** 19.5 **SD:** 19.5 **IW:** 18
Weight: 30 / 40 lbs **Cube:** 10.23

1 2700	2 2805	3 2910	4 3015	5 3120	6 3225	8 4170	COL 1881	S Nail 75	M Nail 90
-----------	-----------	-----------	-----------	-----------	-----------	-----------	-------------	--------------	--------------

L-8854-04

Cleo Arm Chair

Standard Pillows: N/A **Finish Required:** Y
Standard Cushions: High Resiliency 40 **Standard Finish:** N/A
COL: 68 square feet

Width: 22.5 **Depth:** 24.75 **Height:** 31.75
AH: 26 **SH:** 19.5 **SD:** 19.5 **IW:** 18
Weight: 30 / 40 lbs **Cube:** 10.23

1 2625	2 2730	3 2835	4 2940	5 3045	6 3150	8 4095	COL 1881	S Nail 75	M Nail 90
-----------	-----------	-----------	-----------	-----------	-----------	-----------	-------------	--------------	--------------

L-8854-10

Cleo Bench

Leather

Standard Pillows: N/A **Finish Required:** Y
Standard Cushions: High Resiliency 40 **Standard Finish:** N/A
COL: 79 square feet

Width: 52.5 **Depth:** 24.75 **Height:** 32
AH: 25.5 **SH:** 20 **SD:** 19.5 **IW:** 47.75
Weight: 52 / 52 lbs **Cube:** 24.06

1 3375	2 3495	3 3615	4 3735	5 3855	6 3975	8 5070	COL 2595	S Nail 120	M Nail N/A
-----------	-----------	-----------	-----------	-----------	-----------	-----------	-------------	---------------	---------------

L-8854-40

Cleo Settee

Leather

Standard Pillows: N/A **Finish Required:** Y
Standard Cushions: High Resiliency 40 **Standard Finish:** N/A
COL: 107 square feet

Width: 64.5 **Depth:** 24.75 **Height:** 32
AH: 25.5 **SH:** 20 **SD:** 19.5 **IW:** 47.75
Weight: 58 / 58 lbs **Cube:** 29.56

1 3825	2 3990	3 4155	4 4320	5 4485	6 4650	8 6120	COL 2829	S Nail 135	M Nail N/A
-----------	-----------	-----------	-----------	-----------	-----------	-----------	-------------	---------------	---------------

BE09-DT — Price: \$6147**Standard Finish:** BLONDE WALNUT **Country:** USA**Blonde Crotch Cut Walnut 109" Dining Table Top****Collection:** LIVE EDGE**Width:** 109 **Depth:** 46 **Height:** 2 **Weight:** 200 / 0 lbs **Cube:** 5.8**Materials:** Crotch Walnut**BE09-DT-A — Price:** \$14997**Standard Finish:** BLONDE WALNUT **Country:** USA**Dining Table Top****Collection:** LIVE EDGE**Width:** 109 **Depth:** 46 **Height:** 2 **Weight:** 200 / 200 lbs **Cube:** 5.8**Materials:** Crotch Walnut,Resin**BE09-DT-R — Price:** \$14997**Standard Finish:** BLONDE WALNUT **Country:** USA**Dining Table Top****Collection:** LIVE EDGE**Width:** 109 **Depth:** 46 **Height:** 2 **Weight:** 200 / 200 lbs **Cube:** 5.8**Materials:** Crotch Walnut,Resin**BE54-WD — Price:** \$4947**Standard Finish:** BLONDE WALNUT **Country:** USA
Natural American Walnut with acrylic square base**Blonde Crotch Cut Walnut 54" Waterfall Desk****Collection:** LIVE EDGE**Width:** 54 **Depth:** 46 **Height:** 30 **Weight:** 210 / 210 lbs **Cube:** 48.86**Materials:** Crotch Walnut & Acrylic**BE64-TP — Price:** \$2187**Standard Finish:** BLONDE WALNUT **Country:** USA**Blonde Crotch Cut Walnut 64" Table Top****Collection:** LIVE EDGE**Width:** 64 **Depth:** 18 **Height:** 2 **Weight:** 57 / 57 lbs **Cube:** 4.27**Materials:** Crotch Walnut**BE72-BT — Price:** \$3597**Standard Finish:** BLONDE WALNUT **Country:** USA**Blonde Crotch Cut Walnut 72" Dining Table Top****Collection:** LIVE EDGE**Width:** 72 **Depth:** 46 **Height:** 2 **Weight:** 97 / 97 lbs **Cube:** 9.57**Materials:** Crotch Walnut**BE84-DT — Price:** \$4887**Standard Finish:** BLONDE WALNUT **Country:** USA**Blonde Crotch Cut Walnut 84" Dining Table Top****Collection:** LIVE EDGE**Width:** 84 **Depth:** 46 **Height:** 2 **Weight:** 150 / 150 lbs **Cube:** 4.47**Materials:** Crotch Walnut**BE84-DT-A — Price:** \$12897**Standard Finish:** BLONDE WALNUT **Country:** USA**Dining Table Top****Collection:** LIVE EDGE**Width:** 84 **Depth:** 46 **Height:** 2 **Weight:** 150 / 150 lbs **Cube:** 4.47**Materials:** Crotch Walnut,Resin**BE84-DT-R — Price:** \$12897**Standard Finish:** BLONDE WALNUT **Country:** USA**Dining Table Top****Collection:** LIVE EDGE**Width:** 84 **Depth:** 46 **Height:** 2 **Weight:** 150 / 150 lbs **Cube:** 4.47**Materials:** Crotch Walnut,Resin**CAR1-40 — Price:** \$4647**Standard Finish:** N/A **Country:** INDIA
Features leather racing seats with working headlights.**Day Tripper Repurposed Car Settee****Collection:****Width:** 68 **Depth:** 32 **Height:** 34 **Weight:** 176 / 176 lbs **Cube:** 55.51**Materials:****CW09-DT — Price:** \$6597**Standard Finish:** Natural **Country:** USA
Natural American Walnut.**Crotch Cut Walnut 109" Rectangular Table Top****Collection:** LIVE EDGE**Width:** 109 **Depth:** 46 **Height:** 2 **Weight:** 200 / 200 lbs **Cube:** 16.75**Materials:** Crotch Walnut**CW09-DT-A — Price:** \$13497**Standard Finish:** Natural **Country:** USA**Crotch Cut Walnut 109" Rectangular River Table Top****Collection:** LIVE EDGE**Width:** 109 **Depth:** 46 **Height:** 2 **Weight:** 200 / 200 lbs **Cube:** 5.8**Materials:** Crotch Walnut Solids,Epoxy Resin

CASEGOODS

CW09-DT-R — Price: \$13497

Crotch Cut Walnut 109" Rectangular River Table Top

Collection: LIVE EDGE

Width: 109 Depth: 46 Height: 2 Weight: 200 / 200 lbs Cube: 16.75

Materials: Crotch Walnut,Epoxy Resin

Standard Finish: Natural **Country:** USA
Natural American Walnut.

CW54-DK — Price: \$3897

Crotch Cut Walnut 54" Desk Top

Collection: LIVE EDGE

Width: 54 Depth: 0 Height: 2 Weight: 155 / 155 lbs Cube: 5.77

Materials: Crotch Walnut

Standard Finish: Natural **Country:** USA
Natural American Walnut.

CW54-WC — Price: \$4467

Crotch Cut Walnut 54" Waterfall Cocktail Table

Collection: LIVE EDGE

Width: 54 Depth: 0 Height: 18 Weight: 119 / 119 lbs Cube: 30.83

Materials: Crotch Walnut & Acrylic

Standard Finish: Natural **Country:** USA
Natural American Walnut with acrylic square base.

CW54-WD — Price: \$5277

Crotch Cut Walnut 54" Waterfall Desk

Collection: LIVE EDGE

Width: 54 Depth: 0 Height: 30 Weight: 155 / 210 lbs Cube: 48.86

Materials: Crotch Walnut & Acrylic

Standard Finish: Natural **Country:** USA
Natural American Walnut with acrylic square base.

CW56-96 — Price: \$3627

Crotch Cut Walnut Console Table

Collection: LIVE EDGE

Width: 56 Depth: 20 Height: 36 Weight: 134 / 134 lbs Cube: 26.03

Materials: Crotch Walnut & Metal

Standard Finish: Natural **Country:** CHINA
Natural American Walnut Stretcher, Black Nickel finish on a Stainless Steel Base with a 3/4" tempered glass top.

CW64-TP — Price: \$2307

Crotch Cut Walnut 64" Rectangular Table Top

Collection: LIVE EDGE

Width: 64 Depth: 18 Height: 2 Weight: 57 / 57 lbs Cube: 4.27

Materials: Crotch Walnut

Standard Finish: Natural **Country:** USA
Natural American Walnut.

CW72-BT — Price: \$3807

Crotch Cut Walnut 72" Rectangular Table Top

Collection: LIVE EDGE

Width: 72 Depth: 0 Height: 2 Weight: 97 / 97 lbs Cube: 9.57

Materials: Crotch Walnut

Standard Finish: Natural **Country:** USA
Natural American Walnut.

CW84-DT — Price: \$5217

Crotch Cut Walnut 84" Rectangular Table Top

Collection: LIVE EDGE

Width: 84 Depth: 46 Height: 2 Weight: 150 / 150 lbs Cube: 13.41

Materials: Crotch Walnut

Standard Finish: Natural **Country:** USA
Natural American Walnut.

CW84-DT-A — Price: \$11397

Crotch Cut Walnut 84" Rectangular River Table Top

Collection: LIVE EDGE

Width: 84 Depth: 46 Height: 2 Weight: 150 / 150 lbs Cube: 4.47

Materials: Crotch Walnut Solids,Epoxy Resin

Standard Finish: Natural **Country:** USA

CW84-DT-R — Price: \$11397

Crotch Cut Walnut 84" Rectangular River Table Top

Collection: LIVE EDGE

Width: 84 Depth: 46 Height: 2 Weight: 150 / 150 lbs Cube: 13.41

Materials: Crotch Walnut,Epoxy Resin

Standard Finish: Natural **Country:** USA
Natural American Walnut.

GLAS-54 — Price: \$1197

54" Glass Top

Collection:

Width: 54 Depth: 54 Height: 0.5 Weight: 108 / 108 lbs Cube: 6.69

Materials: Tempered Glass

Standard Finish: N/A **Country:** CHINA
Ogee Edge

GLAS-60 — Price: \$1317

60" Glass Top

Collection:

Width: 60 Depth: 60 Height: 0.5 Weight: 136 / 136 lbs Cube: 8.42

Materials: Tempered Glass

Standard Finish: N/A **Country:** CHINA
Ogee Edge

CASEGOODS

HG09-DT — Price: \$8007

Heritage Guanacaste 109" Rectangular Table Top

Collection: LIVE EDGE

Width: 109 **Depth:** 0 **Height:** 2 **Weight:** 231 / 231 lbs **Cube:** 15.87

Materials: Guanacaste

Standard Finish: Heritage **Country:** USA
Heritage stained Guanacaste.

HG22-AT — Price: \$1707

Heritage Guanacaste 22" Round Table Top

Collection: LIVE EDGE

Width: 22 **Depth:** 22 **Height:** 2 **Weight:** 41 / 41 lbs **Cube:** 1.8

Materials: Guanacaste

Standard Finish: Heritage **Country:** USA
Heritage stained Guanacaste.

HG22-ET — Price: \$1857

Heritage Guanacaste 22" Square Table Top

Collection: LIVE EDGE

Width: 22 **Depth:** 22 **Height:** 2 **Weight:** 38 / 38 lbs **Cube:** 1.8

Materials: Guanacaste

Standard Finish: Heritage **Country:** USA
Heritage stained Guanacaste.

HG38-RT — Price: \$4047

Heritage Guanacaste 38" Round Table Top

Collection: LIVE EDGE

Width: 38 **Depth:** 0 **Height:** 2 **Weight:** 55 / 55 lbs **Cube:** 4.86

Materials: Guanacaste

Standard Finish: Heritage **Country:** USA
Heritage stained Guanacaste.

HG48-CT — Price: \$3417

Heritage Guanacaste 48" Square Table Top

Collection: LIVE EDGE

Width: 48 **Depth:** 30 **Height:** 2 **Weight:** 76 / 76 lbs **Cube:** 7.87

Materials: Guanacaste

Standard Finish: Heritage **Country:** USA
Heritage stained Guanacaste.

HG48-RT — Price: \$5787

Heritage Guanacaste 48" Round Table Top

Collection: LIVE EDGE

Width: 48 **Depth:** 48 **Height:** 2 **Weight:** 80 / 80 lbs **Cube:** 7.52

Materials: Guanacaste

Standard Finish: Heritage **Country:** USA
Heritage stained Guanacaste.

HG54-DK — Price: \$4197

Heritage Guanacaste 54" Desk Top

Collection: LIVE EDGE

Width: 54 **Depth:** 0 **Height:** 2 **Weight:** 81 / 81 lbs **Cube:** 8.46

Materials: Guanacaste

Standard Finish: Heritage **Country:** USA
Heritage stained Guanacaste.

HG54-RC — Price: \$3957

Heritage Guanacaste 54" Rectangular Table Top

Collection: LIVE EDGE

Width: 54 **Depth:** 0 **Height:** 2 **Weight:** 66 / 66 lbs **Cube:** 6.05

Materials: Guanacaste

Standard Finish: Heritage **Country:** USA
Heritage stained Guanacaste.

HG54-WC — Price: \$4917

Heritage Guanacaste 54" Waterfall Cocktail Table

Collection: LIVE EDGE

Width: 54 **Depth:** 0 **Height:** 18 **Weight:** 119 / 119 lbs **Cube:** 30.83

Materials: Guanacaste & Acrylic

Standard Finish: Heritage **Country:** USA
Heritage stained Guanacaste with acrylic square base.

HG54-WD — Price: \$5937

Heritage Guanacaste 54" Waterfall Desk

Collection: LIVE EDGE

Width: 54 **Depth:** 0 **Height:** 30 **Weight:** 155 / 155 lbs **Cube:** 48.76

Materials: Guanacaste & Acrylic

Standard Finish: Heritage **Country:** USA
Heritage stained Guanacaste with acrylic square base.

HG72-BT — Price: \$4197

Heritage Guanacaste 72" Rectangular Table Top

Collection: LIVE EDGE

Width: 72 **Depth:** 0 **Height:** 2 **Weight:** 0 / 82 lbs **Cube:** 9.57

Materials: Guanacaste

Standard Finish: Heritage **Country:** USA
Heritage stained Guanacaste.

HG84-DT — Price: \$6297

Heritage Guanacaste 84" Rectangular Table Top

Collection: LIVE EDGE

Width: 84 **Depth:** 0 **Height:** 2 **Weight:** 142 / 142 lbs **Cube:** 13.35

Materials: Guanacaste

Standard Finish: Heritage **Country:** USA
Heritage stained Guanacaste.

CASEGOODS

HP16-4B — Price: \$957

Four Hair Pin 16" Legs

Collection: LIVE EDGE

Width: 4.5 Depth: 4.5 Height: 16 Weight: 12 / 12 lbs Cube: 0.51

Materials: Metal

Standard Finish: Bronze Country: USA

Set of four metal legs in Bronze finish.

HP16-4G — Price: \$957

Four Hair Pin 16" Legs

Collection: LIVE EDGE

Width: 4.5 Depth: 4.5 Height: 16 Weight: 12 / 12 lbs Cube: 0.61

Materials: Metal

Standard Finish: Gold Country: USA

Set of four metal legs in Gold finish.

HP32-3B — Price: \$777

Three Hair Pin 16" Legs

Collection: LIVE EDGE

Width: 4.5 Depth: 4.5 Height: 32 Weight: 18 / 18 lbs Cube: 1.46

Materials: Metal

Standard Finish: Bronze Country: USA

Set of three metal legs in Bronze finish.

HP32-3G — Price: \$777

Three Hair Pin 32" Legs

Collection: LIVE EDGE

Width: 4.5 Depth: 4.5 Height: 32 Weight: 18 / 18 lbs Cube: 1.13

Materials: Metal

Standard Finish: Gold Country: USA

Set of three metal legs in Gold finish.

HP32-4B — Price: \$987

Four Hair Pin 32" Legs

Collection: LIVE EDGE

Width: 4.5 Depth: 4.5 Height: 32 Weight: 24 / 24 lbs Cube: 1.41

Materials: Metal

Standard Finish: Bronze Country: USA

Set of four metal legs in Bronze finish.

HP32-4G — Price: \$987

Hair Pin 32" Legs

Collection: LIVE EDGE

Width: 4.5 Depth: 4.5 Height: 32 Weight: 24 / 24 lbs Cube: 1.46

Materials: Metal

Standard Finish: Gold Country: USA

Set of four metal legs in Gold finish.

LEAS-BT — Price: \$1077

Acrylic Square Counter Height Base

Collection: LIVE EDGE

Width: 20 Depth: 2 Height: 34 Weight: 29 / 29 lbs Cube: 4.42

Materials: Acrylic

Standard Finish: Acrylic Country: CHINA

This style is sold as one base. When pairing with our Live Edge tops two bases are required.

LEAS-DT — Price: \$1047

Acrylic Square Dining Height Base

Collection: LIVE EDGE

Width: 24 Depth: 2 Height: 28 Weight: 32 / 32 lbs Cube: 4.36

Materials: Acrylic

Standard Finish: Acrylic Country: CHINA

This style is sold as one base. When pairing with our Live Edge two bases are required.

LEAS-PT — Price: \$1257

Acrylic Square Bar Height Base

Collection: LIVE EDGE

Width: 20 Depth: 2 Height: 38 Weight: 33 / 33 lbs Cube: 5.02

Materials: Acrylic

Standard Finish: Acrylic Country: CHINA

This style is sold as one base. When pairing with our Live Edge two bases are required.

LEAW-BT — Price: \$1107

Acrylic Wedge Counter Height Base

Collection: LIVE EDGE

Width: 20 Depth: 10 Height: 34 Weight: 37 / 37 lbs Cube: 8.07

Materials: Acrylic

Standard Finish: Acrylic Country: CHINA

This style is sold as one base. When pairing with our Live Edge two bases are required.

LEAW-DT — Price: \$1107

Acrylic Wedge Dining Height Base

Collection: LIVE EDGE

Width: 24 Depth: 12 Height: 28 Weight: 37 / 37 lbs Cube: 8.92

Materials: Acrylic

Standard Finish: Acrylic Country: CHINA

This style is sold as one base. When pairing with our Live Edge two bases are required.

LEAW-PT — Price: \$1167

Acrylic Wedge Bar Height Base

Collection: LIVE EDGE

Width: 20 Depth: 10 Height: 38 Weight: 42 / 42 lbs Cube: 8.91

Materials: Acrylic

Standard Finish: Acrylic Country: CHINA

This style is sold as one base. When pairing with our Live Edge two bases are required.

LEDX-DT — Price: \$1437**Double X Dining Height Base****Collection:** LIVE EDGE**Width:** 68 **Depth:** 36.5 **Height:** 28 **Weight:** 58 / 66 lbs **Cube:** 70.78**Materials:** Beech Solids**Standard Finish:** Tobacco **Country:** USA
Finished in Tobacco.**LEMB-FD — Price:** \$1437**Metal Desk Base****Collection:** LIVE EDGE**Width:** 54 **Depth:** 0 **Height:** 30 **Weight:** 74 / 74 lbs **Cube:** 9**Materials:** Quartered Oak Veneers & Solids with a Black Nickel Metal Base**Standard Finish:** Black Nickel **Country:** CHINA

Metal frame finished in Black Nickel with one drawer and one file drawer with self-closing drawer guides finished in a rustic finish. Pairs with Live Edge 54" tops.

LEMW-BT-1 — Price: \$897**Metal Wedge Counter Height Base****Collection:** LIVE EDGE, LAMINATE TABLE TOP AND BASE**Width:** 20 **Depth:** 10.5 **Height:** 34 **Weight:** 11 / 11 lbs **Cube:** 6.12**Materials:** Metal**Standard Finish:** Bronze **Country:** USA

Bronze finish metal base.

LEMW-DT-1 — Price: \$807**Metal Wedge Dining Height Base****Collection:** LIVE EDGE, LAMINATE TABLE TOP AND BASE**Width:** 24 **Depth:** 12.5 **Height:** 28 **Weight:** 10 / 10 lbs **Cube:** 6.51**Materials:** Metal**Standard Finish:** Bronze **Country:** CHINA

Bronze finish metal base.

LERM-DT — Price: \$2997**Balboa Dining Table Base****Collection:** LIVE EDGE**Width:** 49.5 **Depth:** 26 **Height:** 28 **Weight:** 291 / 291 lbs **Cube:** 20.85**Materials:** Metal**Standard Finish:** Bronze **Country:** INDIA**LETW-DT — Price:** \$2307**Metal Twist Dining Height Base****Collection:** LIVE EDGE**Width:** 56 **Depth:** 28 **Height:** 28 **Weight:** 79 / 79 lbs **Cube:** 17.29**Materials:** Metal**Standard Finish:** N/A **Country:** INDIA

Metal base finished in Black.

LETZ-BT-2 — Price: \$687**Metal Trapezoid Counter Height Base****Collection:** LIVE EDGE**Width:** 22 **Depth:** 3 **Height:** 34 **Weight:** 20 / 20 lbs **Cube:** 1.74**Materials:** Metal**Standard Finish:** Nickel **Country:** USA

Nickel finish on metal. This style is sold as one base. When pairing with our Live Edge two bases are required.

LETZ-BT-3 — Price: \$987**Metal Trapezoid Counter Height Base****Collection:** LIVE EDGE**Width:** 22 **Depth:** 3 **Height:** 34 **Weight:** 20 / 16 lbs **Cube:** 2.63**Materials:** Metal**Standard Finish:** Black Nickel **Country:** CHINA

Black Nickel finish on metal. This style is sold as one base. When pairing with our Live Edge two bases are required.

LETZ-DT-1 — Price: \$687**Metal Trapezoid Dining Height Base****Collection:** LIVE EDGE**Width:** 22 **Depth:** 3 **Height:** 28 **Weight:** 19 / 19 lbs **Cube:** 1.59**Materials:** Metal**Standard Finish:** Bronze **Country:** CHINA

Bronze finish on metal. This style is sold as one base. When pairing with our Live Edge two bases are required.

LETZ-PT-1 — Price: \$687**Metal Trapezoid Bar Height Base****Collection:** LIVE EDGE**Width:** 22 **Depth:** 3 **Height:** 38 **Weight:** 22 / 22 lbs **Cube:** 1.85**Materials:** Metal**Standard Finish:** Bronze **Country:** CHINA

Bronze finish on metal. This style is sold as one base. When pairing with our Live Edge two bases are required.

LETZ-PT-2 — Price: \$687**Metal Trapezoid Bar Height Base****Collection:** LIVE EDGE**Width:** 22 **Depth:** 3 **Height:** 38 **Weight:** 22 / 22 lbs **Cube:** 1.85**Materials:** Metal**Standard Finish:** Nickel **Country:** USA

Nickel finish on metal. This style is sold as one base. When pairing with our Live Edge two bases are required.

LETZ-PT-3 — Price: \$1017**Metal Trapezoid Bar Height Base****Collection:** LIVE EDGE**Width:** 22 **Depth:** 3 **Height:** 38 **Weight:** 22 / 17 lbs **Cube:** 2.9**Materials:** Metal**Standard Finish:** Black Nickel **Country:** CHINA

Black Nickel finish on metal. This style is sold as one base. When pairing with our Live Edge two bases are required.

CASEGOODS

LE09-DT — Price: \$7197

Natural Guanacaste 109" Rectangular Table Top

Collection: LIVE EDGE

Width: 109 Depth: 0 Height: 2 Weight: 231 / 231 lbs Cube: 16.76

Materials: Guanacaste

Standard Finish: Natural **Country:** USA
Natural Guanacaste

LE14-AT — Price: \$957

Natural Guanacaste 14" Round Table Top

Collection: LIVE EDGE

Width: 14 Depth: 14 Height: 2.5 Weight: 18 / 18 lbs Cube: 3.07

Materials: Guanacaste

Standard Finish: Natural **Country:** USA
Natural Guanacaste

LE16-3B — Price: \$597

Three Metal 16" Legs

Collection: LIVE EDGE

Width: 0 Depth: 0 Height: 16 Weight: 5 / 5 lbs Cube: 0.18

Materials: Metal

Standard Finish: Bronze **Country:** CHINA
Three metal legs finished in Bronze.

LE20-3B — Price: \$687

Three Metal 20" Legs

Collection: LIVE EDGE

Width: 0 Depth: 0 Height: 20 Weight: 7 / 7 lbs Cube: 0.22

Materials: Metal

Standard Finish: Bronze **Country:** CHINA
Three metal legs finished in Bronze.

LE20-3N — Price: \$687

Metal 20" Legs

Collection: LIVE EDGE

Width: 0 Depth: 0 Height: 20 Weight: 7 / 7 lbs Cube: 0.22

Materials: Metal

Standard Finish: Nickel **Country:** USA
Three metal legs finished in Nickel.

LE22-AT — Price: \$1647

Natural Guanacaste 22" Round Table Top

Collection: LIVE EDGE

Width: 22 Depth: 22 Height: 2 Weight: 41 / 41 lbs Cube: 3.76

Materials: Guanacaste

Standard Finish: Natural **Country:** USA
Natural Guanacaste

LE22-ET — Price: \$1677

Natural Guanacaste 22" Square Table Top

Collection: LIVE EDGE

Width: 22 Depth: 22 Height: 2 Weight: 38 / 38 lbs Cube: 3.56

Materials: Guanacaste

Standard Finish: Natural **Country:** USA
Natural Guanacaste

LE38-RT — Price: \$3717

Natural Guanacaste 38" Round Table Top

Collection: LIVE EDGE

Width: 38 Depth: 0 Height: 3 Weight: 55 / 55 lbs Cube: 6.51

Materials: Guanacaste

Standard Finish: Natural **Country:** USA
Natural Guanacaste

LE38-SR — Price: \$3957

Natural Guanacaste 38" Diameter Two Piece Cocktail Table

Collection: LIVE EDGE

Width: 38 Depth: 38 Height: 2 Weight: 99 / 99 lbs Cube: 28.69

Materials: Guanacaste & Metal

Standard Finish: Bronze **Country:** USA
Split, round top in Natural Guanacaste with a metal base finished in Bronze.

LE38-96 — Price: \$1827

Natural Guanacaste Demilune Top

Collection: LIVE EDGE

Width: 36 Depth: 18 Height: 2 Weight: 30 / 30 lbs Cube: 2.99

Materials: Guanacaste

Standard Finish: Natural **Country:** USA
Demilune shaped top in Natural Guanacaste.

LE48-CT — Price: \$3177

Natural Guanacaste 48" Square Table Top

Collection: LIVE EDGE

Width: 48 Depth: 30 Height: 2 Weight: 83 / 83 lbs Cube: 7.87

Materials: Guanacaste

Standard Finish: Natural **Country:** USA
Natural Guanacaste

LE48-RT — Price: \$5607

Natural Guanacaste 48" Round Table Top

Collection: LIVE EDGE

Width: 48 Depth: 48 Height: 2 Weight: 80 / 80 lbs Cube: 6.38

Materials: Guanacaste

Standard Finish: Natural **Country:** USA
Natural Guanacaste

CASEGOODS

LE54-DK — Price: \$3957

Natural Guanacaste 54" Desk Top

Collection: LIVE EDGE

Width: 54 Depth: 0 Height: 2 Weight: 81 / 81 lbs Cube: 5.77

Materials: Guanacaste

Standard Finish: Natural **Country:** USA
Natural Guanacaste

LE54-RC — Price: \$3087

Natural Guanacaste 54" Rectangular Cocktail Table Top

Collection: LIVE EDGE

Width: 54 Depth: 0 Height: 2 Weight: 66 / 66 lbs Cube: 6.05

Materials: Guanacaste

Standard Finish: Natural **Country:** USA
Natural Guanacaste

LE54-WC — Price: \$4467

Natural Guanacaste 54" Waterfall Cocktail Table

Collection: LIVE EDGE

Width: 54 Depth: 0 Height: 18 Weight: 119 / 119 lbs Cube: 30.83

Materials: Guanacaste

Standard Finish: Natural **Country:** USA
Natural Guanacaste with an acrylic square base.

LE54-WD — Price: \$5607

Natural Guanacaste 54" Waterfall Desk

Collection: LIVE EDGE

Width: 54 Depth: 0 Height: 30 Weight: 155 / 155 lbs Cube: 48.76

Materials: Guanacaste

Standard Finish: Natural **Country:** USA
Natural Guanacaste with an acrylic square base.

LE72-BT — Price: \$4107

Natural Guanacaste 72" Rectangular Table Top

Collection: LIVE EDGE

Width: 72 Depth: 0 Height: 2 Weight: 97 / 97 lbs Cube: 9.57

Materials: Guanacaste

Standard Finish: Natural **Country:** USA
Natural Guanacaste

LE84-DT — Price: \$5817

Natural Guanacaste 84" Rectangular Table Top

Collection: LIVE EDGE

Width: 84 Depth: 0 Height: 2 Weight: 142 / 142 lbs Cube: 13.35

Materials: Guanacaste

Standard Finish: Natural **Country:** USA
Natural Guanacaste

NM54-DK — Price: \$4047

Live Edge Natural Maple 54" Desk Top

Collection: LIVE EDGE

Width: 54 Depth: 32 Height: 2 Weight: 96 / 96 lbs Cube: 7.87

Materials: Curly Maple

Standard Finish: natural maple **Country:** USA

PG04-AT — Price: \$1017

Impressionable Surfaces Accent Table

Collection: IMPRESSIONABLE SURFACES

Width: 15.75 Depth: 15.75 Height: 19.75 Weight: 23 / 23 lbs Cube: 4.98

Materials: Metal & Glass

Standard Finish: Nickel **Country:** VIETNAM
Hand painted gold finish on an iron base with reverse printed glass.

PG05-AT — Price: \$957

Impressionable Surfaces Accent Table

Collection: IMPRESSIONABLE SURFACES

Width: 15.75 Depth: 15.75 Height: 19.75 Weight: 20 / 20 lbs Cube: 4.93

Materials: Metal & Glass

Standard Finish: Bronze **Country:** VIETNAM
Hand painted bronze finish on an iron base with reverse printed glass.

PG06-AT — Price: \$1227

Impressionable Surfaces Accent Table

Collection: IMPRESSIONABLE SURFACES

Width: 19.75 Depth: 19.75 Height: 19.75 Weight: 43 / 43 lbs Cube: 7.7

Materials: Metal & Glass

Standard Finish: N/A **Country:** VIETNAM
Hand painted bronze finish on an iron base with reverse printed glass.

PG07-AT — Price: \$1227

Impressionable Surfaces Accent Table

Collection: IMPRESSIONABLE SURFACES

Width: 19.75 Depth: 19.75 Height: 19.75 Weight: 46 / 46 lbs Cube: 8.37

Materials: Metal & Glass

Standard Finish: N/A **Country:** VIETNAM
Hand painted gold finish on an iron base with reverse printed glass.

TRAY-T1 — Price: \$327

Benvenuto Accent Tray

Collection: SUNDRIES

Width: 26 Depth: 26 Height: 2 Weight: 64 / 64 lbs Cube: 0.78

Materials: Oak Solids and Veneers

Standard Finish: Almond Buff **Country:** CHINA
Protective: Underneath this tray we have covered the tray with a felt bottom to help protect table tops and counter surfaces.

CASEGOODS

TRAY-T2 — Price: \$327

Benvenuto Accent Tray

Collection: SUNDRIES

Width: 26 Depth: 26 Height: 2 Weight: 64 / 64 lbs Cube: 0.78

Materials: Birch Solids and Veneers

Standard Finish: Cerused Espresso **Country:** CHINA

Protective: Underneath this tray we have covered the tray with a felt bottom to help protect table tops and counter surfaces.

YOYO-14-1 — Price: \$717

Three Yoyo Metal Legs

Collection: LIVE EDGE

Width: 2.5 Depth: 2.5 Height: 14 Weight: 4 / 4 lbs Cube: 0.35

Materials: Metal

Standard Finish: Bronze **Country:** USA

Set of three metal legs in Bronze finish.

YOYO-14-7 — Price: \$717

Three Yoyo Metal Legs

Collection: LIVE EDGE

Width: 2.5 Depth: 2.5 Height: 14 Weight: 4 / 4 lbs Cube: 0.05

Materials: Metal

Standard Finish: Bright Brass **Country:** USA

Set of three metal legs in Bright Brass finish.

4159-DK — Price: \$747

La Jolla WorkSpace Desk Top

Collection: LA JOLLA, LAMINATE TABLE TOP AND BASE

Width: 54 Depth: 2 Height: 30 Weight: 31 / 31 lbs Cube: 3.8

Materials: High Pressured Laminate with solid wood

Standard Finish: Scrubbed Oak **Country:** CHINA

Laminate desk top finished in Scrubbed Oak with a 28.5" curved opening.

4159-19 — Price: \$837

La Jolla Round End Table

Collection: LA JOLLA, LAMINATE

Width: 24 Depth: 24 Height: 25 Weight: 39 / 39 lbs Cube: 11.92

Materials: High Pressured Laminate with solid wood

Standard Finish: Scrubbed Oak **Country:** CHINA

Laminate finished in Scrubbed Oak with Antique Brass stretchers and ferrules.

4159-88 — Price: \$717

La Jolla Drink Table

Collection: LA JOLLA

Width: 16 Depth: 16 Height: 24.5 Weight: 19 / 19 lbs Cube: 2.4

Materials: High Pressured Laminate with solid wood

Standard Finish: Scrubbed Oak **Country:** CHINA

Laminate finished in Scrubbed Oak with Antique Brass hardware and ferrules.

4159-91 — Price: \$1317

La Jolla Round Cocktail Table

Collection: LA JOLLA

Width: 36 Depth: 36 Height: 18.25 Weight: 62 / 62 lbs Cube: 9.8

Materials: High Pressured Laminate with solid wood

Standard Finish: Scrubbed Oak **Country:** CHINA

Laminate finished in Scrubbed Oak with four open shelves and Antique Brass ferrules.

4160-DK — Price: \$747

La Jolla WorkSpace Desk Top

Collection: LA JOLLA, LAMINATE TABLE TOP AND BASE

Width: 54 Depth: 30 Height: 2 Weight: 31 / 31 lbs Cube: 3.8

Materials: High Pressured Laminate with solid wood

Standard Finish: Fumed Oak **Country:** CHINA

Laminate desk top finished in Fumed Oak with a 28.5" curved opening.

4160-88 — Price: \$717

La Jolla Drink Table

Collection: LA JOLLA

Width: 16 Depth: 16 Height: 24.5 Weight: 19 / 19 lbs Cube: 2.4

Materials: High Pressured Laminate with solid wood

Standard Finish: Fumed Oak **Country:** CHINA

Laminate finished in Fumed Oak with four open shelves and Antique Brass ferrules.

4160-91 — Price: \$1317

La Jolla Round Cocktail Table

Collection: LA JOLLA

Width: 36 Depth: 36 Height: 18.25 Weight: 62 / 62 lbs Cube: 9.8

Materials: High Pressured Laminate with solid wood

Standard Finish: Fumed Oak **Country:** CHINA

Laminate finished in Fumed Oak with four open shelves and Antique Brass ferrules.

4160-98 — Price: \$957

La Jolla Round Cocktail Table

Collection: LA JOLLA

Width: 24 Depth: 24 Height: 25 Weight: 42 / 42 lbs Cube: 11.69

Materials: High Pressured Laminate with solid wood

Standard Finish: Fumed Oak **Country:** CHINA

Laminate finished in Fumed Oak with four open shelves and Antique Brass ferrules.

4161-93 — Price: \$1777

Zuma Cocktail Table

Collection: ZUMA

Width: 46 Depth: 24 Height: 18.5 Weight: 49 / 49 lbs Cube: 8.2

Materials: High Pressured Laminate with solid wood

Standard Finish: Fumed Oak **Country:** CHINA

Commercial grade laminate finished in Fumed Oak with a Carrara marble top and one bottom shelf.

CASEGOODS

4163-19 — Price: \$837

Avignon Round End Table

Collection: AVIGNON,LAMINATE

Width: 24 Depth: 24 Height: 24 Weight: 26 / 26 lbs Cube: 3.24

Materials: Beech Solids & Laminate

Standard Finish: Anjou Country: CHINA

Commercial grade laminate and solid wood in Anjou finish.

4163-86 — Price: \$1257

Avignon Activity Table

Collection: AVIGNON,LAMINATE OCCASIONAL

Width: 36 Depth: 36 Height: 30 Weight: 54 / 54 lbs Cube: 5.79

Materials: Beech Solids & Laminate

Standard Finish: Anjou Country: CHINA

Commercial grade laminate and solid wood in Anjou finish.

4163-88 — Price: \$657

Avignon Drink Table

Collection: AVIGNON,LAMINATE OCCASIONAL

Width: 16 Depth: 16 Height: 23.5 Weight: 16 / 16 lbs Cube: 2.21

Materials: Beech Solids & Laminate

Standard Finish: Anjou Country: CHINA

Commercial grade laminate and solid wood in Anjou finish.

4163-93 — Price: \$1077

Avignon Rectangular Cocktail Table

Collection: AVIGNON,LAMINATE

Width: 48 Depth: 24 Height: 18 Weight: 53 / 53 lbs Cube: 6.58

Materials: Beech Solids & Laminate

Standard Finish: Anjou Country: CHINA

Commercial grade laminate and solid wood in Anjou finish.

4163-94 — Price: \$897

Avignon Square End Table

Collection: AVIGNON,LAMINATE

Width: 24 Depth: 24 Height: 24.5 Weight: 34 / 34 lbs Cube: 3.56

Materials: Beech Solids & Laminate

Standard Finish: Anjou Country: CHINA

Commercial grade laminate and solid wood in Anjou finish.

4163-99 — Price: \$1137

Avignon Console Table

Collection: AVIGNON,LAMINATE OCCASIONAL

Width: 60 Depth: 18 Height: 30 Weight: 54 / 54 lbs Cube: 6.27

Materials: Beech Solids & Laminate

Standard Finish: Anjou Country: CHINA

Commercial grade laminate and solid wood in Anjou finish.

4164-19 — Price: \$837

Avignon Round End Table

Collection: AVIGNON,LAMINATE

Width: 24 Depth: 24 Height: 24 Weight: 26 / 26 lbs Cube: 3.24

Materials: Beech Solids & Laminate

Standard Finish: Louve Country: CHINA

Commercial grade laminate and solid wood in Louve finish.

4164-86 — Price: \$1197

Avignon Activity Table

Collection: AVIGNON,LAMINATE

Width: 36 Depth: 36 Height: 30 Weight: 54 / 54 lbs Cube: 5.79

Materials: Beech Solids & Laminate

Standard Finish: Louve Country: CHINA

Commercial grade laminate and solid wood in Louve finish.

4164-88 — Price: \$657

Avignon Drink Table

Collection: AVIGNON,LAMINATE

Width: 16 Depth: 16 Height: 23.5 Weight: 16 / 16 lbs Cube: 2.21

Materials: Beech Solids & Laminate

Standard Finish: Louve Country: CHINA

Commercial grade laminate and solid wood in Louve finish.

4164-93 — Price: \$1077

Avignon Rectangular Cocktail Table

Collection: AVIGNON,LAMINATE

Width: 48 Depth: 24 Height: 18 Weight: 53 / 53 lbs Cube: 6.58

Materials: Beech Solids & Laminate

Standard Finish: Louve Country: CHINA

Commercial grade laminate and solid wood in Louve finish.

4164-94 — Price: \$867

Avignon Square End Table

Collection: AVIGNON,LAMINATE

Width: 24 Depth: 24 Height: 24.5 Weight: 34 / 34 lbs Cube: 3.56

Materials: Beech Solids & Laminate

Standard Finish: Louve Country: CHINA

Commercial grade laminate and solid wood in Louve finish.

4164-99 — Price: \$1137

Avignon Console Table

Collection: AVIGNON,LAMINATE

Width: 60 Depth: 18 Height: 30 Weight: 54 / 54 lbs Cube: 6.27

Materials: Beech Solids & Laminate

Standard Finish: Louve Country: CHINA

Commercial grade laminate and solid wood in Louve finish.

CASEGOODS

4171-AT — Price: \$927

Crescent Round Accent Table

Collection: CRESCENT

Width: 24 **Depth:** 24 **Height:** 24.5 **Weight:** 22 / 22 lbs **Cube:** 2.53

Materials: High Pressured Laminate with solid wood

Standard Finish: Graystone **Country:** CHINA

Commercial grade laminate in Graystone finish and Nickel ferrules.

4171-86 — Price: \$1407

Crescent Activity and Dining Table

Collection: CRESCENT,LAMINATE

Width: 42 **Depth:** 42 **Height:** 30 **Weight:** 67 / 67 lbs **Cube:** 7.61

Materials: High Pressured Laminate with solid wood

Standard Finish: Graystone **Country:** CHINA

Commercial grade laminate top and solid wood edges finished in Graystone with Nickel casters.

4173-28 — Price: \$807

McDonald Round Accent Table

Collection: LAMINATE,MCDONALD

Width: 23 **Depth:** 23 **Height:** 24.5 **Weight:** 25 / 25 lbs **Cube:** 2.49

Materials: High Pressured Laminate with solid wood

Standard Finish: Walnut **Country:** CHINA

Commercial grade laminate in Walnut finish with one fixed shelf.

4173-86 — Price: \$1197

McDonald Activity and Dining Table

Collection: MCDONALD

Width: 42 **Depth:** 42 **Height:** 30 **Weight:** 70 / 70 lbs **Cube:** 8.49

Materials: High Pressured Laminate with solid wood

Standard Finish: Walnut **Country:** CHINA

Commercial grade laminate in Walnut finish.

4173-94 — Price: \$807

McDonald Square End Table

Collection: LAMINATE,MCDONALD

Width: 26 **Depth:** 26 **Height:** 24.5 **Weight:** 25 / 25 lbs **Cube:** 2.79

Materials: High Pressured Laminate with solid wood

Standard Finish: Walnut **Country:** CHINA

Commercial grade laminate in Walnut finish. Features one fixed shelf.

4173-95 — Price: \$807

McDonald Rectangular End Table

Collection: MCDONALD

Width: 22 **Depth:** 26 **Height:** 24.5 **Weight:** 20 / 20 lbs **Cube:** 2.49

Materials: High Pressured Laminate with solid wood

Standard Finish: Walnut **Country:** CHINA

Commercial grade laminate in Walnut finish.

4173-99 — Price: \$867

McDonald Sofa Table

Collection: MCDONALD

Width: 48 **Depth:** 16 **Height:** 28.5 **Weight:** 30 / 30 lbs **Cube:** 3.26

Materials: High Pressured Laminate with solid wood

Standard Finish: Walnut **Country:** CHINA

Commercial grade laminate in Walnut finish.

4176-AT — Price: \$807

Laminate Round Accent Table

Collection: LAMINATE OCCASIONAL

Width: 23 **Depth:** 23 **Height:** 24.5 **Weight:** 20 / 20 lbs **Cube:** 2.63

Materials: High Pressured Laminate with solid wood

Standard Finish: Light Cherry **Country:** CHINA

Commercial grade laminate in Light Cherry finish.

4177-28 — Price: \$927

Campaigna Round Accent Table

Collection: CAMPAIGNA,LAMINATE

Width: 23 **Depth:** 23 **Height:** 24.5 **Weight:** 20 / 20 lbs **Cube:** 2.7

Materials: High Pressured Laminate with solid wood

Standard Finish: Cafe Mocha **Country:** CHINA

Commercial grade laminate in Café Mocha finish. Features one fixed shelf.

4177-46 — Price: \$1047

Campaigna Oval Cocktail Table

Collection: CAMPAIGNA,LAMINATE

Width: 42 **Depth:** 24 **Height:** 18.5 **Weight:** 40 / 40 lbs **Cube:** 4.57

Materials: High Pressured Laminate with solid wood

Standard Finish: Cafe Mocha **Country:** CHINA

Commercial grade laminate in Café Mocha finish. Features one fixed shelf.

4177-86 — Price: \$1437

Campaigna Activity and Dining Table

Collection: CAMPAIGNA,LAMINATE

Width: 42 **Depth:** 42 **Height:** 30 **Weight:** 50 / 50 lbs **Cube:** 7.36

Materials: High Pressured Laminate with solid wood

Standard Finish: Cafe Mocha **Country:** CHINA

High Pressured Laminate with solid wood.

4177-95 — Price: \$867

Campaigna Rectangular End Table

Collection: CAMPAIGNA,LAMINATE

Width: 22 **Depth:** 26 **Height:** 24.5 **Weight:** 25 / 25 lbs **Cube:** 3.05

Materials: High Pressured Laminate with solid wood

Standard Finish: Cafe Mocha **Country:** CHINA

Commercial grade laminate in Café Mocha finish. Features one fixed shelf.

4179-86 — Price: \$1437**Crescent Activity and Dining Table****Collection:** CRESCENT, LAMINATE**Width:** 42 **Depth:** 42 **Height:** 30 **Weight:** 67 / 67 lbs **Cube:** 7.61**Materials:** High Pressured Laminate with solid wood**Standard Finish:** Suede **Country:** CHINA

Commercial grade laminate in Suede finish with Nickel ferrules.

4200-DT-E — Price: \$3597**Essa Trestle Dining Table****Collection:** BD COLLECTION FOR FAIRFIELD**Width:** 92 **Depth:** 42 **Height:** 30 **Weight:** 243 / 243 lbs **Cube:** 67.08**Materials:** Ash Solids and Veneers**Standard Finish:** ENGLISH HONEY **Country:** CHINA

Also available in any Monogram Finish as M200-DT

4201-DT-A — Price: \$3897**Cooper Dining Table****Collection:** BD COLLECTION FOR FAIRFIELD**Width:** 90 **Depth:** 42 **Height:** 30 **Weight:** 293 / 293 lbs **Cube:** 28.46**Materials:** Ash Solids and Veneers**Standard Finish:** ANTIQUE PINEWOOD **Country:** CHINA

Finished in Antique Pinewood. Features two 18" Leaves. Width with one 18" leaf is 108" and with two 18" leaves is 126". Full Extended Dimensions: 126" x 42" x 31". Also available in any Monogram finish as M201-DT

4201-DT-E — Price: \$3897**Cooper Dining Table****Collection:** BD COLLECTION FOR FAIRFIELD**Width:** 90 **Depth:** 42 **Height:** 30 **Weight:** 293 / 293 lbs **Cube:** 28.46**Materials:** Ash Solids and Veneers**Standard Finish:** ENGLISH HONEY **Country:** CHINA

Finished in English Honey. Features two 18" Leaves. Width with one 18" leaf is 108" and with two 18" leaves is 126". Full Extended Dimensions: 126" x 42" x 31". Also available in any Monogram Finish as M201-DT

421R-26 — Price: \$687**Laminate 26" Round Table Top****Collection:** MASSIMO**Width:** 26 **Depth:** 26 **Height:** 1.25 **Weight:** 55 / 55 lbs **Cube:** 0.48**Materials:** High Pressure Laminate**Standard Finish:** N/A **Country:** CHINA

Features Reversed Beveled Edge Detail. Heathered Gray finish.

421R-36 — Price: \$597**Laminate 36" Round Table Top****Collection:** MASSIMO**Width:** 36 **Depth:** 36 **Height:** 1.25 **Weight:** 44 / 44 lbs **Cube:** 3.52**Materials:** High Pressure Laminate**Standard Finish:** N/A **Country:** CHINA

Features Reversed Beveled Edge Detail. Heathered Gray finish

421S-42 — Price: \$747**Laminate 42" Square Table Top****Collection:** MASSIMO**Width:** 42 **Depth:** 42 **Height:** 1.25 **Weight:** 53 / 53 lbs **Cube:** 4.68**Materials:** High Pressure Laminate**Standard Finish:** N/A **Country:** CHINA

Features Reversed Beveled Edge Detail. Heathered Gray finish

421V-60 — Price: \$837**Laminate 60" Oval Table Top****Collection:** MASSIMO**Width:** 60 **Depth:** 30 **Height:** 1.25 **Weight:** 62 / 62 lbs **Cube:** 4.97**Materials:** High Pressure Laminate**Standard Finish:** N/A **Country:** CHINA

Features Reversed Beveled Edge Detail. Heathered Gray finish

425R-26 — Price: \$687**Laminate 26" Round Table Top****Collection:** MASSIMO**Width:** 26 **Depth:** 26 **Height:** 1.25 **Weight:** 55 / 55 lbs **Cube:** 0.48**Materials:** High Pressure Laminate**Standard Finish:** N/A **Country:** CHINA

Features Reversed Beveled Edge Detail. Midnight finish.

425R-36 — Price: \$597**Laminate 36" Round Table Top****Collection:** MASSIMO**Width:** 36 **Depth:** 36 **Height:** 1.25 **Weight:** 44 / 44 lbs **Cube:** 3.52**Materials:** High Pressure Laminate**Standard Finish:** N/A **Country:** CHINA

Features Reversed Beveled Edge Detail. Midnight finish

425S-42 — Price: \$747**Laminate 42" Square Table Top****Collection:** MASSIMO**Width:** 42 **Depth:** 42 **Height:** 1.25 **Weight:** 53 / 53 lbs **Cube:** 4.68**Materials:** High Pressure Laminate**Standard Finish:** N/A **Country:** CHINA

Features Reversed Beveled Edge Detail. Midnight finish

425V-60 — Price: \$837**Laminate 60" Oval Table Top****Collection:** MASSIMO**Width:** 60 **Depth:** 30 **Height:** 1.25 **Weight:** 62 / 62 lbs **Cube:** 4.97**Materials:** High Pressure Laminate**Standard Finish:** N/A **Country:** CHINA

Features Reversed Beveled Edge Detail. Midnight finish

4305-18 — Price: \$6747**Pamela Curio Cabinet****Collection:** BD COLLECTION FOR FAIRFIELD**Width:** 60 **Depth:** 20 **Height:** 84 **Weight:** 317 / 317 lbs **Cube:** 65.36**Materials:** Ash Solids and Veneers**Standard Finish:** ANTIQUE PINEWOOD **Country:** CHINA

Finished in Antique Pinewood. Features Six Drawers, Two Wooden shelves with plate grooves. Nine display areas. Also available in any Monogram Finish as M305-18.

4306-18 — Price: \$6747**Pamela Curio Cabinet****Collection:** BD COLLECTION FOR FAIRFIELD**Width:** 60 **Depth:** 20 **Height:** 84 **Weight:** 317 / 317 lbs **Cube:** 65.36**Materials:** Ash Solids and Veneers**Standard Finish:** ENGLISH HONEY **Country:** CHINA

Finished in English Honey. Features Six Drawers, Two Wooden shelves with plate grooves. Nine display areas. Also available in any Monogram finish as M305-18

4307-18 — Price: \$6087**Edward Curio Cabinet****Collection:** BD COLLECTION FOR FAIRFIELD**Width:** 60 **Depth:** 17 **Height:** 84 **Weight:** 328 / 328 lbs **Cube:** 47.73**Materials:** Ash Solids and Veneers**Standard Finish:** ANTIQUE PINEWOOD **Country:** CHINA

Finished in Antique Pinewood. Features Three Drawers. Two Glass inset Doors . Two Wooden Shelves. Also available in any Monogram finish as M307-18

4308-18 — Price: \$6087**Edward Curio Cabinet****Collection:** BD COLLECTION FOR FAIRFIELD**Width:** 49 **Depth:** 17 **Height:** 84 **Weight:** 328 / 328 lbs **Cube:** 38.49**Materials:** Ash Solids and Veneers**Standard Finish:** ENGLISH HONEY **Country:** CHINA

Finished in English Honey. Features Three Drawers. Two Glass inset Doors . Two Wooden Shelves. Also available in any Monogram finish as M307-18

4309-18 — Price: \$7887**Alexander Curio Cabinet****Collection:** BD COLLECTION FOR FAIRFIELD**Width:** 49 **Depth:** 17.5 **Height:** 84.25 **Weight:** 380 / 380 lbs **Cube:** 66.6**Materials:** Ash Solids and Veneers**Standard Finish:** ANTIQUE PINEWOOD **Country:** CHINA

Finished in Antique Pinewood. Features Two Sliding Glass Doors, Two Drawers, 2 Shelves. Also available in any Monogram finish as M309-18

4310-18 — Price: \$7887**Alexander Curio Cabinet****Collection:** BD COLLECTION FOR FAIRFIELD**Width:** 49 **Depth:** 17.5 **Height:** 84.25 **Weight:** 380 / 380 lbs **Cube:** 66.6**Materials:** Ash Solids and Veneers**Standard Finish:** ENGLISH HONEY **Country:** CHINA

Finished in English Honey. Features Two Sliding Glass Doors, Two Drawers, 2 Shelves. Also available in any Monogram finish as M309-18

4311-18 — Price: \$7737**Alexander Curio Cabinet****Collection:** BD COLLECTION FOR FAIRFIELD**Width:** 68 **Depth:** 17.5 **Height:** 84.25 **Weight:** 380 / 380 lbs **Cube:** 66.61**Materials:** Ash Solids and Veneers**Standard Finish:** SOFT WHITE **Country:** CHINA

Finished in Soft White. Features Two Sliding Glass Doors, Two Drawers, 2 Shelves. Also available in any Monogram Finish as M309-18.

4312-18 — Price: \$6747**Pamela Curio Cabinet****Collection:** BD COLLECTION FOR FAIRFIELD**Width:** 60 **Depth:** 20 **Height:** 84 **Weight:** 318 / 318 lbs **Cube:** 64.41**Materials:** Ash Solids and Veneers**Standard Finish:** SOFT WHITE **Country:** CHINA

Finished in Soft White. Features Six Drawers, Two Wooden shelves with plate grooves. Nine display areas. Also available in any Monogram Finish as M305-18.

4313-18 — Price: \$6147**Edward Curio Cabinet****Collection:** BD COLLECTION FOR FAIRFIELD**Width:** 68 **Depth:** 17 **Height:** 84 **Weight:** 328 / 328 lbs **Cube:** 54.1**Materials:** Ash Solids and Veneers**Standard Finish:** IRON ORE **Country:** CHINA

Finished in Iron Ore with Soft White Interior. Features Three Drawers. Two Glass inset Doors. Two Wooden Shelves. Also available in any Monogram Finish as M307-18, with contrasting interior finish at an additional charge.

4400-TB — Price: \$2037**Garnett Table Base****Collection:** BD COLLECTION FOR FAIRFIELD**Width:** 30 **Depth:** 30 **Height:** 27.75 **Weight:** 42 / 42 lbs **Cube:** 14.45**Materials:** Alder Solids**Standard Finish:** ANTIQUE PINEWOOD **Country:** CHINA

Also available in any Monogram Finish as M400-TB

4401-TB-A — Price: \$1947**Zoey Table Base****Collection:** BD COLLECTION FOR FAIRFIELD**Width:** 30 **Depth:** 30 **Height:** 28.75 **Weight:** 56 / 56 lbs **Cube:** 9.06**Materials:** Alder Solids**Standard Finish:** ANTIQUE PINEWOOD **Country:** CHINA

Finished In Antique Pinewood. Also available in any Monogram Finish as M401-TB.

4401-TB-E — Price: \$1947**Zoey Table Base****Collection:** BD COLLECTION FOR FAIRFIELD**Width:** 30 **Depth:** 30 **Height:** 28.75 **Weight:** 56 / 56 lbs **Cube:** 9.06**Materials:** Alder Solids**Standard Finish:** ENGLISH HONEY **Country:** CHINA

Finished In English Honey. Also available in any Monogram Finish as M401-TB.

CASEGOODS

4402-TB-A — Price: \$1287

Sycamore Table Base

Collection: BD COLLECTION FOR FAIRFIELD

Width: 24 **Depth:** 24 **Height:** 28.75 **Weight:** 46 / 46 lbs **Cube:** 5.46

Materials: Alder Solids

Standard Finish: ANTIQUE PINEWOOD **Country:** CHINA

Finished In Antique Pinewood. Also available in any Monogram Finish as M402-TB.

4402-TB-E — Price: \$1287

Sycamore Table Base

Collection: BD COLLECTION FOR FAIRFIELD

Width: 24 **Depth:** 24 **Height:** 28.75 **Weight:** 46 / 46 lbs **Cube:** 9.58

Materials: Alder Solids

Standard Finish: ENGLISH HONEY **Country:** CHINA

Finished In English Honey. Also available in any Monogram Finish as M402-TB.

4403-TB-A — Price: \$1287

Estelle Table Base

Collection: BD COLLECTION FOR FAIRFIELD

Width: 24 **Depth:** 24 **Height:** 28.75 **Weight:** 40 / 40 lbs **Cube:** 5.17

Materials: Alder Solids

Standard Finish: ANTIQUE PINEWOOD **Country:** CHINA

Finished in Antique Pinewood. Also available in any Monogram Finish as M403-TB.

4403-TB-E — Price: \$1287

Estelle Table Base

Collection: BD COLLECTION FOR FAIRFIELD

Width: 24 **Depth:** 24 **Height:** 28.75 **Weight:** 40 / 40 lbs **Cube:** 5.17

Materials: Alder Solids

Standard Finish: ENGLISH HONEY **Country:** CHINA

Finished in English Honey. Also available in any Monogram Finish as M403-TB.

4404-TB-4 — Price: \$1167

Molly Table Base

Collection: BD COLLECTION FOR FAIRFIELD

Width: 24 **Depth:** 24 **Height:** 28.75 **Weight:** 16 / 16 lbs **Cube:** 3.84

Materials: Metal

Standard Finish: Brushed Satin **Country:** INDIA

Finished in Brushed Satin. Also Available in Antique Gold Finish.

4404-TB-6 — Price: \$1167

Molly Table Base

Collection: BD COLLECTION FOR FAIRFIELD

Width: 24 **Depth:** 24 **Height:** 28.75 **Weight:** 16 / 16 lbs **Cube:** 3.84

Materials: Metal

Standard Finish: ANTIQUE GOLD **Country:** INDIA

Finished in Antique Gold. Also Available in Brushed Stain.

4405-TB-4 — Price: \$1077

Daisy Table Base

Collection: BD COLLECTION FOR FAIRFIELD

Width: 22 **Depth:** 22 **Height:** 28.75 **Weight:** 22 / 22 lbs **Cube:** 2.94

Materials: Metal

Standard Finish: Brushed Satin **Country:** INDIA

Finished in Brushed Satin. Also Available in Antique Gold Finish.

4405-TB-6 — Price: \$1077

Daisy Table Base

Collection: BD COLLECTION FOR FAIRFIELD

Width: 22 **Depth:** 22 **Height:** 28.75 **Weight:** 22 / 22 lbs **Cube:** 2.94

Materials: Metal

Standard Finish: ANTIQUE GOLD **Country:** INDIA

Finished in Antique Gold. Also Available in Brushed Stain.

4420-TP-A — Price: \$1227

Elliott Table Top

Collection: BD COLLECTION FOR FAIRFIELD

Width: 36 **Depth:** 24 **Height:** 1.25 **Weight:** 60 / 60 lbs **Cube:** 2.49

Materials: Alder Solids, Calcutta Stone

Standard Finish: ANTIQUE PINEWOOD **Country:** CHINA

Finished in Antique Pinewood with Shadow Stone Inset, Eased Edge.

4420-TP-E — Price: \$1227

Elliott Table Top

Collection: BD COLLECTION FOR FAIRFIELD

Width: 36 **Depth:** 24 **Height:** 1.25 **Weight:** 60 / 60 lbs **Cube:** 2.49

Materials: Alder Solids, Calcutta Stone

Standard Finish: ENGLISH HONEY **Country:** CHINA

Finished in English Honey with Shadow Stone Inset, Eased Edge.

4421-TP-A — Price: \$1227

Elliott Table Top

Collection: BD COLLECTION FOR FAIRFIELD

Width: 36 **Depth:** 24 **Height:** 1.25 **Weight:** 60 / 60 lbs **Cube:** 2.49

Materials: Alder Solids, Calcutta Stone

Standard Finish: ANTIQUE PINEWOOD **Country:** CHINA

Finished in Antique Pinewood with Cottage Stone Inset, Eased Edge.

4421-TP-E — Price: \$1227

Elliott Table Top

Collection: BD COLLECTION FOR FAIRFIELD

Width: 36 **Depth:** 24 **Height:** 1.25 **Weight:** 60 / 60 lbs **Cube:** 2.49

Materials: Alder Solids, Calcutta Stone

Standard Finish: ENGLISH HONEY **Country:** CHINA

Finished in English Honey with Cottage Stone Inset, Eased Edge.

CASEGOODS

4424-TP-A — Price: \$597

Karen Table Top

Collection: BD COLLECTION FOR FAIRFIELD
Width: 36 **Depth:** 24 **Height:** 1.25 **Weight:** 37 / 37 lbs **Cube:** 2.52
Materials: Alder Solids and Birch Veneers

Standard Finish: ANTIQUE PINEWOOD **Country:** CHINA
 Finished in Antique Pinewood with a Corner Key Design. Eased Edge. Also available in any Monogram Finish as M424-TP.

4424-TP-E — Price: \$597

Karen Table Top

Collection: BD COLLECTION FOR FAIRFIELD
Width: 36 **Depth:** 24 **Height:** 1.25 **Weight:** 37 / 37 lbs **Cube:** 2.52
Materials: Alder Solids and Birch Veneers

Standard Finish: ENGLISH HONEY **Country:** CHINA
 Finished in English Honey with a Corner Key Design. Eased Edge.

4426-TP-A — Price: \$597

Ava Table Top

Collection: BD COLLECTION FOR FAIRFIELD
Width: 36 **Depth:** 24 **Height:** 1.25 **Weight:** 37 / 37 lbs **Cube:** 2.52
Materials: Alder Solids and Birch Veneers

Standard Finish: ANTIQUE PINEWOOD **Country:** CHINA
 Finished in Antique Pinewood with a Quilt Inlay Design. Eased Edge. Also available in any Monogram Finish as M426-TP.

4426-TP-E — Price: \$597

Avah Table Top

Collection: BD COLLECTION FOR FAIRFIELD
Width: 36 **Depth:** 24 **Height:** 1.25 **Weight:** 37 / 37 lbs **Cube:** 2.52
Materials: Alder Solids and Birch Veneers

Standard Finish: ENGLISH HONEY **Country:** CHINA
 Finished in English Honey with a Quilt Inlay Design. Eased Edge.

4432-TP-A — Price: \$1557

Ludwig Table Top

Collection: BD COLLECTION FOR FAIRFIELD
Width: 36 **Depth:** 36 **Height:** 1.25 **Weight:** 77 / 77 lbs **Cube:** 3.63
Materials: Alder Solids, Calcutta Stone

Standard Finish: ANTIQUE PINEWOOD **Country:** CHINA
 Finished in Antique Pinewood with Shadow Stone Inset. Eased Edge.

4432-TP-E — Price: \$1557

Ludwig Table Top

Collection: BD COLLECTION FOR FAIRFIELD
Width: 36 **Depth:** 36 **Height:** 1.25 **Weight:** 77 / 77 lbs **Cube:** 3.63
Materials: Alder Solids, Calcutta Stone

Standard Finish: ENGLISH HONEY **Country:** CHINA
 Finished in English Honey with Shadow Stone Inset. Eased Edge.

4433-TP-A — Price: \$1557

Ludwig Table Top

Collection: BD COLLECTION FOR FAIRFIELD
Width: 36 **Depth:** 36 **Height:** 1.25 **Weight:** 45 / 45 lbs **Cube:** 0.93
Materials: Alder Solids, Calcutta Stone

Standard Finish: ANTIQUE PINEWOOD **Country:** CHINA
 Finished in Antique Pinewood with Cottage Stone Inset. Eased Edge.

4433-TP-E — Price: \$1557

Ludwig Table Top

Collection: BD COLLECTION FOR FAIRFIELD
Width: 36 **Depth:** 36 **Height:** 1.25 **Weight:** 45 / 45 lbs **Cube:** 0.93
Materials: Alder Solids, Calcutta Stone

Standard Finish: ENGLISH HONEY **Country:** CHINA
 Finished in English Honey with Cottage Stone Inset. Eased Edge.

4434-TP — Price: \$1287

Archie Table Top

Collection: BD COLLECTION FOR FAIRFIELD
Width: 36 **Depth:** 36 **Height:** 1.25 **Weight:** 71 / 71 lbs **Cube:** 0.93
Materials: Stone

Standard Finish: N/A **Country:** CHINA
 Shadow Stone Top.

4435-TP — Price: \$1287

Anne Table Top

Collection: BD COLLECTION FOR FAIRFIELD
Width: 36 **Depth:** 36 **Height:** 1.25 **Weight:** 71 / 71 lbs **Cube:** 0.93
Materials: Stone

Standard Finish: N/A **Country:** CHINA
 Cottage Stone Top.

4440-TP-A — Price: \$1917

Carlisle Table Top

Collection: BD COLLECTION FOR FAIRFIELD
Width: 42 **Depth:** 42 **Height:** 1.25 **Weight:** 122 / 122 lbs **Cube:** 1.27
Materials: Alder Solids, Calcutta Stone

Standard Finish: ANTIQUE PINEWOOD **Country:** CHINA
 Finished in Antique Pinewood with Shadow Stone Inset. Eased Edge.

4440-TP-E — Price: \$1917

Carlisle Table Top

Collection: BD COLLECTION FOR FAIRFIELD
Width: 42 **Depth:** 42 **Height:** 1.25 **Weight:** 122 / 122 lbs **Cube:** 1.27
Materials: Alder Solids, Calcutta Stone

Standard Finish: ENGLISH HONEY **Country:** CHINA
 Finished in English Honey with Shadow Stone Inset. Eased Edge.

4441-TP-A — Price: \$1917**Carlisle Table Top****Collection:** BD COLLECTION FOR FAIRFIELD**Width:** 42 **Depth:** 42 **Height:** 1.25 **Weight:** 122 / 122 lbs **Cube:** 1.27**Materials:** Alder Solids, Calcutta Stone**Standard Finish:** ANTIQUE PINEWOOD **Country:** CHINA

Finished in Antique Pinewood with Cottage Stone Inset. Eased Edge.

4441-TP-E — Price: \$1917**Carlisle Table Top****Collection:** BD COLLECTION FOR FAIRFIELD**Width:** 42 **Depth:** 42 **Height:** 1.25 **Weight:** 122 / 122 lbs **Cube:** 1.27**Materials:** Alder Solids, Calcutta Stone**Standard Finish:** ENGLISH HONEY **Country:** CHINA

Finished in English Honey with Cottage Stone Inset. Eased Edge.

4442-TP — Price: \$897**Hayden Table Top****Collection:** BD COLLECTION FOR FAIRFIELD**Width:** 42 **Depth:** 42 **Height:** 1.25 **Weight:** 139 / 139 lbs **Cube:** 4.73**Materials:** Laminated and Alder Solids**Standard Finish:** Coal **Country:** CHINA

Finished in Coal Finish with Eased Edge.

4443-TP — Price: \$897**Samuel Table Top****Collection:** BD COLLECTION FOR FAIRFIELD**Width:** 42 **Depth:** 42 **Height:** 1.25 **Weight:** 122 / 122 lbs **Cube:** 1.27**Materials:** Laminated and Alder Solids**Standard Finish:** Perfect Walnut **Country:** CHINA

Finished in Perfect Walnut Finish with Eased Edge.

4444-TP-A — Price: \$957**Karen Table Top****Collection:** BD COLLECTION FOR FAIRFIELD**Width:** 42 **Depth:** 42 **Height:** 1.25 **Weight:** 75 / 75 lbs **Cube:** 1.27**Materials:** Alder Solids and Birch Veneers**Standard Finish:** ANTIQUE PINEWOOD **Country:** CHINA

Finished in Antique Pinewood with a Corner Key Design. Eased Edge. Also available in any Monogram Finish as M444-TP.

4444-TP-E — Price: \$957**Karen Table Top****Collection:** BD COLLECTION FOR FAIRFIELD**Width:** 42 **Depth:** 42 **Height:** 1.25 **Weight:** 75 / 75 lbs **Cube:** 1.27**Materials:** Alder Solids and Birch Veneers**Standard Finish:** ENGLISH HONEY **Country:** CHINA

Finished in English Honey with a Corner Key Design. Eased Edge.

4446-TP-A — Price: \$957**Ava Table Top****Collection:** BD COLLECTION FOR FAIRFIELD**Width:** 42 **Depth:** 42 **Height:** 1.25 **Weight:** 90 / 90 lbs **Cube:** 4.73**Materials:** Alder Solids and Birch Veneers**Standard Finish:** ANTIQUE PINEWOOD **Country:** CHINA

Finished in Antique Pinewood with a Quilt Inlay Design. Eased Edge. Also available in any Monogram Finish as M446-TP.

4446-TP-E — Price: \$957**Ava Table Top****Collection:** BD COLLECTION FOR FAIRFIELD**Width:** 60 **Depth:** 42 **Height:** 1.25 **Weight:** 90 / 90 lbs **Cube:** 4.73**Materials:** Alder Solids and Birch Veneers**Standard Finish:** ENGLISH HONEY **Country:** CHINA

Finished in English Honey with a Quilt Inlay Design. Eased Edge.

4450-86 — Price: \$4434**Garnett Activity Table****Collection:** BD COLLECTION FOR FAIRFIELD**Width:** 42 **Depth:** 42 **Height:** 32.25 **Weight:** 0 / 0 lbs **Cube:** 32.92**Materials:** Alder Solids**Standard Finish:** ANTIQUE PINEWOOD **Country:** CHINA

Features an Olive faux-leather activity table top. Features pull-out drink holders on each side.

4452-86 — Price: \$2487**Jess Puzzle Activity Table****Collection:** BD COLLECTION FOR FAIRFIELD**Width:** 54 **Depth:** 31 **Height:** 30.5 **Weight:** 66 / 66 lbs **Cube:** 29.54**Materials:** Alder Solids**Standard Finish:** ENGLISH HONEY **Country:** CHINA

Features two drawers on each side with storage and a work surface in 3109 Flax.

4463-TP-A — Price: \$2067**Carol Table Top****Collection:** BD COLLECTION FOR FAIRFIELD**Width:** 60 **Depth:** 60 **Height:** 1.25 **Weight:** 122 / 122 lbs **Cube:** 9.55**Materials:** Alder Solids and Birch Veneers**Standard Finish:** ANTIQUE PINEWOOD **Country:** CHINA

Finished in Antique Pinewood with a Herringbone Design. Ogee Edge. Also available in any Monogram Finish as M463-TP.

4463-TP-E — Price: \$2067**Carol Table Top****Collection:** BD COLLECTION FOR FAIRFIELD**Width:** 60 **Depth:** 60 **Height:** 1.25 **Weight:** 122 / 122 lbs **Cube:** 9.55**Materials:** Alder Solids and Birch Veneers**Standard Finish:** ENGLISH HONEY **Country:** CHINA

Finished in English Honey with a Herringbone Design. Ogee Edge

4464-TP-A — Price: \$2067**Avah Table Top****Collection:** BD COLLECTION FOR FAIRFIELD**Width:** 60 **Depth:** 60 **Height:** 1.25 **Weight:** 122 / 122 lbs **Cube:** 9.4**Materials:** Alder Solids and Birch Veneers**Standard Finish:** ANTIQUE PINEWOOD **Country:** CHINA

Finished in Antique Pinewood with a Quilt Inlay Design. Ogee Edge.

4464-TP-E — Price: \$2067**Ava Table Top****Collection:** BD COLLECTION FOR FAIRFIELD**Width:** 60 **Depth:** 60 **Height:** 1.25 **Weight:** 122 / 122 lbs **Cube:** 9.4**Materials:** Alder Solids and Birch Veneers**Standard Finish:** ENGLISH HONEY **Country:** CHINA

Finished in English Honey with a Quilt Inlay Design. Ogee Edge. Also available in any Monogram Finish as M464-TP.

471R-42 — Price: \$747**Crescent 42" Round Table Top****Collection:** CRESCENT, LAMINATE TABLE TOP AND BASE**Width:** 42 **Depth:** 42 **Height:** 1.5 **Weight:** 60 / 60 lbs **Cube:** 4.34**Materials:** High Pressured Laminate with solid wood**Standard Finish:** Graystone **Country:** CHINA

Commercial grade laminate in Graystone finish.

471R-48 — Price: \$837**Crescent 48" Round Table Top****Collection:** CRESCENT, LAMINATE TABLE TOP AND BASE**Width:** 48 **Depth:** 48 **Height:** 1.5 **Weight:** 75 / 75 lbs **Cube:** 5.58**Materials:** High Pressured Laminate with solid wood**Standard Finish:** Graystone **Country:** CHINA

Commercial grade laminate in Graystone finish.

471S-48 — Price: \$837**Crescent 48" Square Table Top****Collection:** CRESCENT, LAMINATE TABLE TOP AND BASE**Width:** 48 **Depth:** 28.5 **Height:** 1.5 **Weight:** 96 / 96 lbs **Cube:** 5.58**Materials:** High Pressured Laminate with solid wood**Standard Finish:** Graystone **Country:** CHINA

Commercial grade laminate in Graystone finish.

472R-42 — Price: \$777**Crescent 42" Round Table Top****Collection:** CRESCENT, LAMINATE TABLE TOP AND BASE**Width:** 42 **Depth:** 42 **Height:** 1.25 **Weight:** 60 / 60 lbs **Cube:** 4.39**Materials:** High Pressured Laminate with solid wood**Standard Finish:** Cherry **Country:** CHINA

Commercial grade laminate in Cherry finish.

473R-48 — Price: \$987**McDonald 48" Round Table Top****Collection:** MCDONALD, LAMINATE TABLE TOP AND BASE**Width:** 48 **Depth:** 48 **Height:** 1.75 **Weight:** 65 / 65 lbs **Cube:** 5.11**Materials:** High Pressured Laminate with solid wood**Standard Finish:** Walnut **Country:** CHINA

Commercial grade laminate in Walnut finish.

473S-36 — Price: \$807**McDonald 36" Square Table Top****Collection:** MCDONALD, LAMINATE TABLE TOP AND BASE**Width:** 36 **Depth:** 36 **Height:** 1.75 **Weight:** 45 / 50 lbs **Cube:** 3.21**Materials:** High Pressured Laminate with solid wood**Standard Finish:** Walnut **Country:** CHINA

Commercial grade laminate in Walnut finish.

473S-48 — Price: \$987**McDonald 48" Square Table Top****Collection:** MCDONALD, LAMINATE TABLE TOP AND BASE**Width:** 48 **Depth:** 48 **Height:** 1.75 **Weight:** 96 / 90 lbs **Cube:** 5.53**Materials:** High Pressured Laminate with solid wood**Standard Finish:** Walnut **Country:** CHINA

Commercial grade laminate in Walnut finish.

476R-42 — Price: \$867**42" Round Table Top****Collection:** LAMINATE TABLE TOP AND BASE**Width:** 42 **Depth:** 42 **Height:** 1.75 **Weight:** 55 / 55 lbs **Cube:** 3.39**Materials:** High Pressured Laminate with solid wood**Standard Finish:** Light Cherry **Country:** CHINA

Commercial grade laminate in Light Cherry finish.

476S-36 — Price: \$807**36" Square Table Top****Collection:** LAMINATE TABLE TOP AND BASE**Width:** 36 **Depth:** 36 **Height:** 1.75 **Weight:** 45 / 45 lbs **Cube:** 2.54**Materials:** High Pressured Laminate with solid wood**Standard Finish:** Light Cherry **Country:** CHINA

Commercial grade laminate in Light Cherry finish.

476S-42 — Price: \$867**42" Square Table Top****Collection:** LAMINATE TABLE TOP AND BASE**Width:** 42 **Depth:** 42 **Height:** 1.75 **Weight:** 60 / 60 lbs **Cube:** 3.39**Materials:** High Pressured Laminate with solid wood**Standard Finish:** Light Cherry **Country:** CHINA

Commercial grade laminate in Light Cherry finish.

CASEGOODS

476S-48 — Price: \$927

48" Square Table Top

Collection: LAMINATE TABLE TOP AND BASE

Width: 48 **Depth:** 48 **Height:** 1.75 **Weight:** 85 / 85 lbs **Cube:** 4.36

Materials: High Pressured Laminate with solid wood

Standard Finish: Light Cherry **Country:** CHINA
Commercial grade laminate in Light Cherry finish.

477R-48 — Price: \$927

Campaigna 48" Round Table Top

Collection: CAMPAIGNA, LAMINATE TABLE TOP AND BASE

Width: 48 **Depth:** 48 **Height:** 1.75 **Weight:** 65 / 65 lbs **Cube:** 4.36

Materials: High Pressured Laminate with solid wood

Standard Finish: Cafe Mocha **Country:** CHINA
Commercial grade laminate in Café Mocha finish.

478R-42 — Price: \$747

42" Round Table Top

Collection: LAMINATE TABLE TOP AND BASE

Width: 42 **Depth:** 42 **Height:** 1.75 **Weight:** 50 / 50 lbs **Cube:** 4.59

Materials: High Pressured Laminate with solid wood

Standard Finish: Sable **Country:** CHINA
Commercial grade laminate in Sable finish.

478R-48 — Price: \$807

48" Round Table Top

Collection: LAMINATE TABLE TOP AND BASE

Width: 48 **Depth:** 48 **Height:** 1.75 **Weight:** 65 / 65 lbs **Cube:** 5.06

Materials: High Pressured Laminate with solid wood

Standard Finish: Sable **Country:** CHINA
Commercial grade laminate in Sable finish.

478S-48 — Price: \$807

48" Square Table Top

Collection: LAMINATE TABLE TOP AND BASE

Width: 48 **Depth:** 48 **Height:** 1.75 **Weight:** 75 / 75 lbs **Cube:** 5.06

Materials: High Pressured Laminate with solid wood

Standard Finish: Sable **Country:** CHINA
Commercial grade laminate in Sable finish.

479R-48 — Price: \$807

Crescent 48" Round Table Top

Collection: CRESCENT, LAMINATE TABLE TOP AND BASE

Width: 48 **Depth:** 48 **Height:** 1.5 **Weight:** 73 / 73 lbs **Cube:** 6.02

Materials: High Pressured Laminate with solid wood

Standard Finish: Suede **Country:** CHINA
Commercial grade laminate in Suede finish.

479S-42 — Price: \$747

Crescent 42" Square Table Top

Collection: CRESCENT, LAMINATE TABLE TOP AND BASE

Width: 42 **Depth:** 42 **Height:** 1.5 **Weight:** 69 / 69 lbs **Cube:** 4.68

Materials: High Pressured Laminate with solid wood

Standard Finish: Suede **Country:** CHINA
Commercial grade laminate in Suede finish.

479S-48 — Price: \$807

Crescent 48" Square Table Top

Collection: CRESCENT, LAMINATE TABLE TOP AND BASE

Width: 48 **Depth:** 48 **Height:** 1.5 **Weight:** 89 / 89 lbs **Cube:** 6.02

Materials: High Pressured Laminate with solid wood

Standard Finish: Suede **Country:** CHINA
Commercial grade laminate in Suede finish.

6308-ET — Price: \$1347

Marlowe Tiered Round End Table

Collection: LIBBY LANGDON FOR FAIRFIELD

Width: 26 **Depth:** 26 **Height:** 25 **Weight:** 51 / 51 lbs **Cube:** 9.78

Materials: Stainless Steel, Walnut Solids and Veneers

Standard Finish: SMOKED STONE **Country:** CHINA
Features one top with Walnut veneers and a lower antique mirror shelf, Smoked Stone Finish and Champagne Metal. Also available in any Monogram Finish as M308-ET.

6308-13 — Price: \$1497

Marlowe Tiered Round Cocktail Table

Collection: LIBBY LANGDON FOR FAIRFIELD

Width: 42 **Depth:** 42 **Height:** 18 **Weight:** 77 / 77 lbs **Cube:** 18.37

Materials: Stainless Steel, Walnut Solids and Veneers

Standard Finish: SMOKED STONE **Country:** CHINA
Features one top with Walnut veneers and a lower antique mirror shelf, Smoked Stone and Champagne Metal. Also available in any Monogram Finish as M308-13.

6309-CS — Price: \$987

Kylie Drink Table

Collection: LIBBY LANGDON FOR FAIRFIELD

Width: 16 **Depth:** 16 **Height:** 22 **Weight:** 8 / 8 lbs **Cube:** 3.25

Materials: Metal and Antique Glass

Standard Finish: Champagne **Country:** INDIA
Features Antique Mirror glass and Champagne Metal.

6310-BC — Price: \$1347

Wayne End Table

Collection: LIBBY LANGDON FOR FAIRFIELD

Width: 24 **Depth:** 24 **Height:** 24 **Weight:** 69 / 0 lbs **Cube:** 8

Materials: Onyx Stone Top, Mango Solids and Metal Accents

Standard Finish: Dark Sable **Country:** INDIA

6315-19 — Price: \$837**Zeller End Table****Collection:** LIBBY LANGDON FOR FAIRFIELD**Width:** 24 **Depth:** 24 **Height:** 24 **Weight:** 32 / 32 lbs **Cube:** 8**Materials:** Stainless Steel, Ash Solids and Veneers**Standard Finish:** Cerused Espresso **Country:** CHINA
Also available in any Monogram Finish as M315-19.**6316-96 — Price:** \$2007**Simone Writing Desk****Collection:** LIBBY LANGDON FOR FAIRFIELD**Width:** 60 **Depth:** 22 **Height:** 30 **Weight:** 96 / 96 lbs **Cube:** 7.66**Materials:** Stainless Steel, Acrylic, Walnut Solids and Veneers**Standard Finish:** SMOKED STONE **Country:** CHINA

Features two drawers with soft close guides. Also available in any Monogram Finish as M316-96.

6317-DT — Price: \$2847**Clement Dining Table****Collection:** LIBBY LANGDON FOR FAIRFIELD**Width:** 76 **Depth:** 40 **Height:** 30 **Weight:** 320 / 320 lbs **Cube:** 52.77**Materials:** Stainless Steel, Oak Solids and Eucalyptus Veneers**Standard Finish:** SMOKED STONE **Country:** CHINA

Features one 24" filler. Also available in any Monogram Finish as M317-DT.

6320-88 — Price: \$747**Rosso Drink Table****Collection:** LIBBY LANGDON FOR FAIRFIELD**Width:** 14 **Depth:** 14 **Height:** 22.25 **Weight:** 19 / 19 lbs **Cube:** 2.51**Materials:** Stainless Steel and Marquina Stone**Standard Finish:** N/A **Country:** INDIA**6321-88 — Price:** \$987**Mangold Drink Table****Collection:** LIBBY LANGDON FOR FAIRFIELD**Width:** 11 **Depth:** 11 **Height:** 24 **Weight:** 11 / 11 lbs **Cube:** 1.68**Materials:** Glass, Stainless Steel**Standard Finish:** Champagne **Country:** CHINA**6322-CH — Price:** \$2397**Farley Five Drawer Chest****Collection:** LIBBY LANGDON FOR FAIRFIELD**Width:** 36 **Depth:** 20 **Height:** 55 **Weight:** 222 / 222 lbs **Cube:** 22.91**Materials:** Walnut Solids and Veneers**Standard Finish:** SMOKED STONE **Country:** VIETNAM

Features five extension drawers with nickel hardware. Also available in any Monogram Finish as M322-CH.

6322-ET — Price: \$1647**Farley Small End Table****Collection:** LIBBY LANGDON FOR FAIRFIELD**Width:** 28 **Depth:** 20 **Height:** 28 **Weight:** 108 / 108 lbs **Cube:** 9.07**Materials:** Walnut Solids and Veneers**Standard Finish:** SMOKED STONE **Country:** VIETNAM

Features three full extension drawers with nickel hardware. Also available in any Monogram Finish as M322-ET.

6322-17 — Price: \$2997**Farley Six Drawer Chest****Collection:** LIBBY LANGDON FOR FAIRFIELD**Width:** 78 **Depth:** 20 **Height:** 37 **Weight:** 293 / 293 lbs **Cube:** 33.4**Materials:** Walnut Solids and Veneers**Standard Finish:** SMOKED STONE **Country:** VIETNAM

Features six full extension drawers with nickel hardware. Also available in any Monogram Finish as M322-17.

6322-38 — Price: \$1797**Farley Large End Table****Collection:** LIBBY LANGDON FOR FAIRFIELD**Width:** 36 **Depth:** 20 **Height:** 28 **Weight:** 141 / 141 lbs **Cube:** 11.66**Materials:** Walnut Solids and Veneers**Standard Finish:** SMOKED STONE **Country:** VIETNAM

Features two full extension drawers with nickel hardware. Also available in any Monogram Finish as M322-38.

6322-KB — Price: \$3597**Farley King Bed****Collection:** LIBBY LANGDON FOR FAIRFIELD**Width:** 80 **Depth:** 84 **Height:** 67 **Weight:** 320 / 320 lbs **Cube:** 260.55**Materials:** Walnut Solids and Veneers**Standard Finish:** SMOKED STONE **Country:** VIETNAM

Features nickel ferrules and nickel beaded accents. A box-spring is not required for this bed.

6322-QB — Price: \$3297**Farley Queen Bed****Collection:** LIBBY LANGDON FOR FAIRFIELD**Width:** 64 **Depth:** 84 **Height:** 67 **Weight:** 254 / 254 lbs **Cube:** 208.44**Materials:** Walnut Solids and Veneers**Standard Finish:** SMOKED STONE **Country:** VIETNAM

Features nickel ferrules and nickel beaded accents. A box-spring is not required for this bed.

6323-TB — Price: \$2247**Ellerson Dining Table Base****Collection:** LIBBY LANGDON FOR FAIRFIELD**Width:** 45 **Depth:** 22 **Height:** 28.5 **Weight:** 82 / 82 lbs **Cube:** 17.16**Materials:** Stainless Steel**Standard Finish:** Nickel **Country:** INDIA

6700-TC — Price: \$2697**Randall Tier Cocktail****Collection:** LIBBY LANGDON FOR FAIRFIELD**Width:** 28 **Depth:** 36 **Height:** 19 **Weight:** 96 / 96 lbs **Cube:** 20.1**Materials:** Walnut Solids & Veneers**Standard Finish:** Cerused Espresso **Country:** CHINA

Polished Nickel metal frame, top shelf: glass, middle shelf: White Carrara Stone, bottom shelf: wood with one side finished in Cerused Espresso and one side finished in Sheer Dove.

6701-92 — Price: \$2037**Peconic Square Cocktail Table****Collection:** LIBBY LANGDON FOR FAIRFIELD**Width:** 40 **Depth:** 40 **Height:** 18 **Weight:** 75 / 75 lbs **Cube:** 23**Materials:** Quartered Ash Solids & Veneers**Standard Finish:** Sheer Dove **Country:** CHINA

Finished in Sheer Dove. Also available in any Monogram Finish as M701-92.

6702-93 — Price: \$2037**Dune Rectangular Cocktail Table****Collection:** LIBBY LANGDON FOR FAIRFIELD**Width:** 48 **Depth:** 28 **Height:** 18 **Weight:** 149 / 149 lbs **Cube:** 18.9**Materials:** Quartered Ash Solids & Veneers**Standard Finish:** White Lacquer **Country:** CHINA

Finished in White Lacquer with one fixed shelf.

6703-12 — Price: \$2307**Gansett Nesting Cocktail Table****Collection:** LIBBY LANGDON FOR FAIRFIELD**Width:** 48 **Depth:** 28 **Height:** 19 **Weight:** 123 / 123 lbs **Cube:** 20.12**Materials:** Ash Solids**Standard Finish:** Dark Sable **Country:** CHINA

Large table: glass top. Small table: White Carrara Stone top. Dark Sable wood finish.

6721-47 — Price: \$1437**Wheelock End Table****Collection:** LIBBY LANGDON FOR FAIRFIELD**Width:** 28 **Depth:** 22 **Height:** 24 **Weight:** 37 / 37 lbs **Cube:** 12**Materials:** Quartered Ash Solids & Veneers**Standard Finish:** Sheer Dove **Country:** CHINA

Oval wood top finished in Sheer Dove with a curved, metal base in Dark Bronze. Also available in any Monogram Finish as M721-47.

6722-19 — Price: \$1497**Oakleigh End Table****Collection:** LIBBY LANGDON FOR FAIRFIELD**Width:** 28 **Depth:** 28 **Height:** 24 **Weight:** 46 / 46 lbs **Cube:** 3.89**Materials:** Birch Solids & Walnut Veneers**Standard Finish:** Dark Sable **Country:** CHINA

Dark Sable finish. Also available in any Monogram Finish as M722-19.

6723-37 — Price: \$1887**Foster Left Side Facing Open End Table****Collection:** LIBBY LANGDON FOR FAIRFIELD**Width:** 30 **Depth:** 20 **Height:** 26 **Weight:** 114 / 114 lbs **Cube:** 12.48**Materials:** Birch Solids & Walnut Veneers**Standard Finish:** Dark Sable **Country:** CHINA

Finished in Dark Sable with one soft-close drawer, two fixed shelves. Also available in any Monogram Finish as M723-37.

6724-ET — Price: \$1797**Redfield End Table****Collection:** LIBBY LANGDON FOR FAIRFIELD**Width:** 27 **Depth:** 15 **Height:** 25 **Weight:** 60 / 60 lbs **Cube:** 8.68**Materials:** Polished Nickel Stainless Steel with Black Stone Top**Standard Finish:** N/A **Country:** CHINA

Polished Nickel base with a black Granite top.

6725-95 — Price: \$1737**Gibson End Table****Collection:** LIBBY LANGDON FOR FAIRFIELD**Width:** 24 **Depth:** 24 **Height:** 24 **Weight:** 76 / 76 lbs **Cube:** 11.39**Materials:** Quartered Ash Solids & Veneers**Standard Finish:** Dark Sable **Country:** CHINA

Finished in Dark Sable with one soft-close drawer, one fixed shelf and a fluted, brushed brass pull. Also available in any Monogram Finish as M725-95.

6726-TE — Price: \$687**Jayden Chairside Table****Collection:** LIBBY LANGDON FOR FAIRFIELD**Width:** 18 **Depth:** 14 **Height:** 22 **Weight:** 50 / 40 lbs **Cube:** 6.61**Materials:** Metal & Carrera Marble**Standard Finish:** Champagne **Country:** INDIA

Champagne finished metal frame. Top shelf is glass, lower shelf is Carrara Marble.

6727-CS — Price: \$687**Rogers Chairside Table****Collection:** LIBBY LANGDON FOR FAIRFIELD**Width:** 16 **Depth:** 16 **Height:** 24 **Weight:** 38 / 38 lbs **Cube:** 5.62**Materials:** Metal & Carrara Marble**Standard Finish:** Champagne **Country:** INDIA

Champagne finished metal frame with a white, Carrara Marble top.

6730-95 — Price: \$957**Michaela Drink Table****Collection:** LIBBY LANGDON FOR FAIRFIELD**Width:** 20 **Depth:** 12 **Height:** 24 **Weight:** 41 / 41 lbs **Cube:** 5.7**Materials:** Mango Solids, Metal**Standard Finish:** Modern Truffle **Country:** INDIA

Finished in Modern Truffle with Brushed Champagne metal accents. Features one drawer and one hidden drop-lid storage compartment.

6740-CH-M — Price: \$3957**Heatherwood Chest****Collection:** LIBBY LANGDON FOR FAIRFIELD**Width:** 60 **Depth:** 20 **Height:** 36 **Weight:** 164 / 164 lbs **Cube:** 32.7**Materials:** Walnut Solids & Veneers**Standard Finish:** Modern Truffle **Country:** CHINA

Finished in Modern Truffle with Polished Nickel accents and six, soft-close drawers. Also available in any Monogram Finish as M740-CH.

6740-CH-S — Price: \$3957**Heatherwood Chest****Collection:** LIBBY LANGDON FOR FAIRFIELD**Width:** 60 **Depth:** 20 **Height:** 36 **Weight:** 164 / 164 lbs **Cube:** 32.7**Materials:** Walnut Solids and Veneers**Standard Finish:** Sheer Dove **Country:** CHINA

Finished in Sheer Dove with Polished Nickel accents and six, soft-close drawers. Also available in any Monogram Finish as M740-CH.

6740-ET-M — Price: \$2157**Heatherwood End Table****Collection:** LIBBY LANGDON FOR FAIRFIELD**Width:** 34 **Depth:** 20 **Height:** 28 **Weight:** 87 / 87 lbs **Cube:** 15.26**Materials:** Walnut Solids & Veneers**Standard Finish:** Modern Truffle **Country:** CHINA

Finished in Modern Truffle with Polished Nickel accents and two, soft-close drawers. Also available in any Monogram Finish as M740-ET.

6740-ET-S — Price: \$2157**Heatherwood End Table****Collection:** LIBBY LANGDON FOR FAIRFIELD**Width:** 34 **Depth:** 20 **Height:** 28 **Weight:** 87 / 87 lbs **Cube:** 15.26**Materials:** Walnut Solids and Veneers**Standard Finish:** Sheer Dove **Country:** CHINA

Finished in Sheer Dove with Polished Nickel accents and two, soft-close drawers. Also available in any Monogram Finish as M740-ET.

6740-17-M — Price: \$5697**Heatherwood Master Chest****Collection:** LIBBY LANGDON FOR FAIRFIELD**Width:** 76 **Depth:** 20 **Height:** 36 **Weight:** 287 / 287 lbs **Cube:** 40.74**Materials:** Walnut Solids & Veneers**Standard Finish:** Modern Truffle **Country:** CHINA

Finished in Modern Truffle with Polished Nickel accents and nine, soft-close drawers.

6740-17-S — Price: \$5697**Heatherwood Master Chest****Collection:** LIBBY LANGDON FOR FAIRFIELD**Width:** 76 **Depth:** 20 **Height:** 36 **Weight:** 287 / 287 lbs **Cube:** 40.74**Materials:** Walnut Solids and Veneers**Standard Finish:** Sheer Dove **Country:** CHINA

Finished in Sheer Dove with Polished Nickel accents and nine, soft-close drawers. Also available in any Monogram Finish as M740-17.

6740-38-M — Price: \$2787**Heatherwood Large End Table****Collection:** LIBBY LANGDON FOR FAIRFIELD**Width:** 38 **Depth:** 20 **Height:** 32 **Weight:** 135 / 135 lbs **Cube:** 18.89**Materials:** Walnut Solids & Veneers**Standard Finish:** Modern Truffle **Country:** CHINA

Finished in Modern Truffle with Polished Nickel accents, and two soft-close drawers. The top drawer features an electrical outlet with two USB ports. Also available in any Monogram Finish as M740-38.

6740-38-S — Price: \$2787**Heatherwood Large End Table****Collection:** LIBBY LANGDON FOR FAIRFIELD**Width:** 38 **Depth:** 20 **Height:** 32 **Weight:** 135 / 135 lbs **Cube:** 18.89**Materials:** Walnut Solids and Veneers**Standard Finish:** Sheer Dove **Country:** CHINA

Finished in Sheer Dove with Polished Nickel accents, and two soft-close drawers. The top drawer features an electrical outlet with two USB ports. Also available in any Monogram Finish as M740-38.

6741-ET-M — Price: \$2247**Miller End Table****Collection:** LIBBY LANGDON FOR FAIRFIELD**Width:** 28 **Depth:** 22 **Height:** 28 **Weight:** 86 / 86 lbs **Cube:** 13.9**Materials:** Walnut Solids and Veneers**Standard Finish:** Modern Truffle **Country:** CHINA

Finished in Modern Truffle with Brushed Brass metal accents, one open storage shelf, and two soft-close drawers. Also available in any Monogram Finish as M741-ET.

6741-ET-S — Price: \$2247**Miller End Table****Collection:** LIBBY LANGDON FOR FAIRFIELD**Width:** 28 **Depth:** 22 **Height:** 28 **Weight:** 86 / 103 lbs **Cube:** 13.57**Materials:** Walnut Solids & Veneers**Standard Finish:** Sheer Dove **Country:** CHINA

Finished in Sheer Dove with Brushed Brass metal accents, one open storage shelf, and two soft-close drawers. Also available in any Monogram Finish as M741-ET.

6741-17-M — Price: \$5397**Miller Master Chest****Collection:** LIBBY LANGDON FOR FAIRFIELD**Width:** 76 **Depth:** 20 **Height:** 36 **Weight:** 300 / 300 lbs **Cube:** 40.74**Materials:** Walnut Solids & Veneers**Standard Finish:** Modern Truffle **Country:** CHINA

Finished in Modern Truffle with Brushed Brass metal accents and nine soft-close drawers. Also available in any Monogram Finish as M741-17.

6741-17-S — Price: \$5397**Miller Master Chest****Collection:** LIBBY LANGDON FOR FAIRFIELD**Width:** 76 **Depth:** 20 **Height:** 36 **Weight:** 300 / 300 lbs **Cube:** 49.6**Materials:** Walnut Solids & Veneers**Standard Finish:** Sheer Dove **Country:** CHINA

Finished in Sheer Dove with Brushed Brass metal accents and nine soft-close drawers. Also available in any Monogram Finish as M741-17.

6741-38-M — Price: \$2997**Miller Large End Table****Collection:** LIBBY LANGDON FOR FAIRFIELD**Width:** 40 **Depth:** 22 **Height:** 32 **Weight:** 138 / 138 lbs **Cube:** 21.52**Materials:** Walnut Solids and Veneers**Standard Finish:** Modern Truffle **Country:** CHINA

Finished in Modern Truffle with Brushed Brass metal accents, one open storage shelf, and two soft-close drawers. Also available in any Monogram Finish as M741-38.

6760-93 — Price: \$3387**Millstone Cocktail Table****Collection:** LIBBY LANGDON FOR FAIRFIELD**Width:** 50 **Depth:** 30 **Height:** 18.75 **Weight:** 148 / 148 lbs **Cube:** 9.8**Materials:** Dark Bronze Metal & Calcutta Marble**Standard Finish:** N/A **Country:** CHINA

Metal base finished in Dark Bronze, gray and white Calcutta Marble top.

6760-95 — Price: \$2307**Millstone End Table****Collection:** LIBBY LANGDON FOR FAIRFIELD**Width:** 26 **Depth:** 20 **Height:** 25 **Weight:** 80 / 80 lbs **Cube:** 4.51**Materials:** Dark Bronze Metal & Calcutta Marble**Standard Finish:** N/A **Country:** CHINA

Metal base finished in Dark Bronze, gray and white Calcutta Marble top.

6760-96 — Price: \$3387**Millstone Console Table****Collection:** LIBBY LANGDON FOR FAIRFIELD**Width:** 54 **Depth:** 14 **Height:** 34 **Weight:** 138 / 138 lbs **Cube:** 20.38**Materials:** Dark Bronze Metal & Calcutta Marble**Standard Finish:** N/A **Country:** CHINA

Metal base finished in Dark Bronze, gray and white Calcutta Marble top.

6761-96 — Price: \$1497**Herbert Console****Collection:** LIBBY LANGDON FOR FAIRFIELD**Width:** 50 **Depth:** 12 **Height:** 31 **Weight:** 84 / 84 lbs **Cube:** 10.76**Materials:** Walnut Solids and Veneers**Standard Finish:** Dark Sable **Country:** CHINA

Dark Sable exterior with Soft White Interior. Also available in any Monogram Finish as M761-96.

6762-96 — Price: \$2307**Lendell Console Table****Collection:** LIBBY LANGDON FOR FAIRFIELD**Width:** 64 **Depth:** 16 **Height:** 36 **Weight:** 163 / 163 lbs **Cube:** 27.55**Materials:** Quartered Ash Solids & Veneers**Standard Finish:** Dark Sable **Country:** CHINA

Finished in Dark Sable with one fixed shelf and three soft-close drawers wrapped in Glazed Tan linen. Also available in any Monogram Finish as M762-96.

6763-17 — Price: \$5607**Hillcrest Credenza****Collection:** LIBBY LANGDON FOR FAIRFIELD**Width:** 69 **Depth:** 16 **Height:** 36 **Weight:** 197 / 197 lbs **Cube:** 31.63**Materials:** Birch Solids & Walnut Veneers**Standard Finish:** Sheer Dove **Country:** CHINA

Finished in Sheer Dove with Polished Nickel accents and two soft-close drawers. Storage areas behind two sets of doors feature adjustable shelves and cord exit holes. Also available in any Monogram Finish as M763-17.

6763-96 — Price: \$3177**Hillcrest Console Table****Collection:** LIBBY LANGDON FOR FAIRFIELD**Width:** 46 **Depth:** 16 **Height:** 36 **Weight:** 117 / 117 lbs **Cube:** 21.01**Materials:** Birch Solids & Walnut Veneers**Standard Finish:** Sheer Dove **Country:** CHINA

Finished in Sheer Dove with Polished Nickel accents and two soft-close drawers. Storage area behind two doors feature one adjustable shelf and a cord exit hole. Also available in any Monogram Finish as M763-96

6764-81 — Price: \$2157**Lionel Console Desk****Collection:** LIBBY LANGDON FOR FAIRFIELD**Width:** 56 **Depth:** 20 **Height:** 30 **Weight:** 106 / 106 lbs **Cube:** 10.69**Materials:** Birch Solids & Walnut Veneers**Standard Finish:** Dark Sable **Country:** CHINA

Finished in Dark Sable with Antique Brass metal accents and ferrules. Three drawers. Also available in any Monogram Finish as M764-81.

6765-96-2 — Price: \$3387**Jessup Console Table****Collection:** LIBBY LANGDON FOR FAIRFIELD**Width:** 54 **Depth:** 20 **Height:** 36 **Weight:** 135 / 135 lbs **Cube:** 29.25**Materials:** Stainless Steel with Carrara Marble Top**Standard Finish:** Nickel **Country:** CHINA

Stainless steel base finished in Nickel and white Carrara Marble top. Sized to accommodate two 6765-07-2 Jessup Counter Stools.

6766-96 — Price: \$4197**Barker Credenza****Collection:** LIBBY LANGDON FOR FAIRFIELD**Width:** 74 **Depth:** 14 **Height:** 32 **Weight:** 0 / 0 lbs **Cube:** 19.17**Materials:** White Carrara Stone, Metal**Standard Finish:** Champagne **Country:** INDIA

Features two drawers. Inset carrera marble on top and all shelves. Consists of 6766-96-T (Top) and 6766-96-B (Base)

6780-81 — Price: \$3117**Patton Desk****Collection:** LIBBY LANGDON FOR FAIRFIELD**Width:** 54 **Depth:** 24 **Height:** 30 **Weight:** 148 / 148 lbs **Cube:** 15.61**Materials:** Walnut Solids and Veneers**Standard Finish:** Sheer Dove **Country:** CHINA

Sheer Dove Finish. Brass Hardware pulls. Three drawers and one file drawer. Center drawer has a drop-down lid. Also available in any Monogram Finish as M780-81.

6800-DT — Price: \$5097**Lynncliff Dining Table****Collection:** LIBBY LANGDON FOR FAIRFIELD**Width:** 84 **Depth:** 42 **Height:** 30 **Weight:** 286 / 286 lbs **Cube:** 50.55**Materials:** Quartered Ash Solids & Veneers**Standard Finish:** Dark Sable **Country:** CHINA

Finished in Dark Sable with two, 22" removable leaves and equalizing slide mechanism. Consists of 6800-DT-B (Base) and 6800-DT-T (Top). Also available in any Monogram Finish as M800-DT

6801-DT — Price: \$4137**Whitby Dining Table****Collection:** LIBBY LANGDON FOR FAIRFIELD**Width:** 88 **Depth:** 42 **Height:** 30 **Weight:** 165 / 165 lbs **Cube:** 22.01**Materials:** Alder Solids & Walnut Veneers**Standard Finish:** Cerused Espresso **Country:** CHINA

Finished in Cerused Espresso with Polished Nickel ferrules and medallions. Consists of 6801-DT-B (Base) and 6801-DT-T (Top). Also available in any Monogram Finish as M801-DT

6802-DT — Price: \$3567**Bellows Dining Table****Collection:** LIBBY LANGDON FOR FAIRFIELD**Width:** 54 **Depth:** 54 **Height:** 30 **Weight:** 164 / 164 lbs **Cube:** 16.79**Materials:** Quartered Ash Solids & Veneers**Standard Finish:** Sheer Dove **Country:** CHINA

Finished in Sheer Dove. Consists of 6802-DT-B (Base) and 6802-DT-T (Top). Also available in any Monogram Finish as M802-DT.

6803-DT — Price: \$3597**Hotchner Round Dining Table****Collection:** LIBBY LANGDON FOR FAIRFIELD**Width:** 48 **Depth:** 48 **Height:** 30.5 **Weight:** 217 / 217 lbs **Cube:** 40.66**Materials:** Stainless Steel, Acrylic, Walnut Solids and Veneers**Standard Finish:** SMOKED STONE **Country:** CHINA

Features a 22" filler. Also available in any Monogram Finish as M803-DT.

6820-17 — Price: \$4947**Winston Credenza****Collection:** LIBBY LANGDON FOR FAIRFIELD**Width:** 72 **Depth:** 20 **Height:** 38 **Weight:** 252 / 252 lbs **Cube:** 42.7**Materials:** Walnut Solids & Veneers**Standard Finish:** Sheer Dove **Country:** CHINA

Finished in Sheer Dove with Polished Nickel metal accents and one soft-close drawer. Two storage areas feature door openings with adjustable shelves and cord exit holes. Also available in any Monogram Finish as M820-17.

6821-17 — Price: \$5637**Baystone Credenza****Collection:** LIBBY LANGDON FOR FAIRFIELD**Width:** 80 **Depth:** 20 **Height:** 39 **Weight:** 302 / 302 lbs **Cube:** 46.39**Materials:** Alder Solids & Walnut Veneers**Standard Finish:** Modern Truffle **Country:** CHINA

Finished in Modern Truffle with Polished Nickel hardware and ferrules. Features five soft-close drawers, and storage areas with cord exit holes behind two doors. Also available in any Monogram Finish as M821-17.

6822-17 — Price: \$4197**Merritt Credenza****Collection:** LIBBY LANGDON FOR FAIRFIELD**Width:** 72 **Depth:** 18 **Height:** 35 **Weight:** 292 / 292 lbs **Cube:** 26.25**Materials:** Stainless Steel, Walnut Solids and Veneers**Standard Finish:** SMOKED STONE **Country:** CHINA

Features a Stainless Steel base and accents, Nickel Hardware, Four doors with one shelf behind each door. One center drawer with silver tray liner. Also available in any Monogram Finish as M822-17.

6840-85 — Price: \$5697**Wesley Etageré****Collection:** LIBBY LANGDON FOR FAIRFIELD**Width:** 36 **Depth:** 14 **Height:** 90 **Weight:** 216 / 216 lbs **Cube:** 33.41**Materials:** Ash Solids**Standard Finish:** Cerused Espresso **Country:** CHINA

Finished in Cerused Espresso with Brushed Brass metal accents, three glass shelves, and touch LED lighting.

6841-85 — Price: \$5697**Wesley Etageré****Collection:** LIBBY LANGDON FOR FAIRFIELD**Width:** 36 **Depth:** 14 **Height:** 90 **Weight:** 216 / 216 lbs **Cube:** 33.41**Materials:** Ash Solids**Standard Finish:** Sheer Dove **Country:** CHINA

Finished in Sheer Dove with Brushed Brass metal accents, three glass shelves, and touch LED lighting.

8000-CS — Price: \$447**Palermo Drink Table****Collection:** PALERMO**Width:** 12 **Depth:** 12 **Height:** 22 **Weight:** 82 / 82 lbs **Cube:** 1.83**Materials:** Chiseled White Marble, Stainless Steel**Standard Finish:** N/A **Country:** INDIA**8000-DK — Price:** \$2547**Palermo Desk****Collection:** PALERMO**Width:** 60 **Depth:** 30 **Height:** 30 **Weight:** 331 / 331 lbs **Cube:** 31.25**Materials:** Chiseled White Marble, Stainless Steel**Standard Finish:** N/A **Country:** INDIA

Features four metal shelves.

8000-DT — Price: \$2997**Palermo Round Dining Table****Collection:** PALERMO**Width:** 48 **Depth:** 48 **Height:** 30.5 **Weight:** 262 / 262 lbs **Cube:** 28.64**Materials:** Chiseled White Marble, Stainless Steel**Standard Finish:** N/A **Country:** INDIA

Table consists of 8000-DT-T Top and 8000-DT-B Base.

CASEGOODS

8000-13 — Price: \$1737

Palermo Round Cocktail Table

Collection: PALERMO

Width: 36 **Depth:** 36 **Height:** 19 **Weight:** 127 / 127 lbs **Cube:** 14.25

Materials: Chiseled White Marble, Stainless Steel

Standard Finish: N/A **Country:** INDIA

Table consists of 8000-13-T Top and 8000-13-B Base.

8000-19 — Price: \$1107

Palermo Round End Table

Collection: PALERMO

Width: 24 **Depth:** 24 **Height:** 24 **Weight:** 65 / 65 lbs **Cube:** 0

Materials: Chiseled White Marble, Stainless Steel

Standard Finish: N/A **Country:** INDIA

Table consists of 8000-19-T Top and 8000-19-B Base.

8000-88 — Price: \$687

Equestrian Tack Drink Table

Collection: SUNDRIES

Width: 18 **Depth:** 9 **Height:** 20 **Weight:** 26 / 26 lbs **Cube:** 1.87

Materials: Mango Solids, Iron

Standard Finish: N/A **Country:** INDIA

Solid Mango Log in a Blackwashed finish, Iron Base in Antique Zinc Finish.

8000-93 — Price: \$1947

Palermo Rectangular Cocktail Table

Collection: PALERMO

Width: 50 **Depth:** 30 **Height:** 16.5 **Weight:** 129 / 129 lbs **Cube:** 0

Materials: Chiseled White Marble, Stainless Steel

Standard Finish: N/A **Country:** INDIA

Table consists of 8000-93-T Top and 8000-93-B Base.

8000-99 — Price: \$1737

Palermo Console Table

Collection: PALERMO

Width: 60 **Depth:** 14 **Height:** 30 **Weight:** 100 / 100 lbs **Cube:** 23.73

Materials: Chiseled White Marble, Stainless Steel

Standard Finish: N/A **Country:** INDIA

Table consists of 8000-99-T Top and 8000-99-B Base.

8001-DT — Price: \$3897

Portofino Dining Table

Collection: PORTOFINO

Width: 58 **Depth:** 58 **Height:** 30 **Weight:** 201 / 201 lbs **Cube:** 23.87

Materials: White Oak Solids and Veneers

Standard Finish: LINEN **Country:** CHINA

Linen Finish. Features One 22" Leaf. Extended Dimension: 80x80x30. Also available in any Monogram Finish as M001-DT.

8001-17 — Price: \$4797

Portofino Credenza

Collection: PORTOFINO

Width: 72 **Depth:** 21 **Height:** 38 **Weight:** 269 / 269 lbs **Cube:** 36.83

Materials: White Oak Solids and Veneers

Standard Finish: LINEN **Country:** CHINA

Linen Finish. Four Doors, Four Adjustable shelves. Also available in any Monogram Finish as M001-17.

8001-81 — Price: \$3387

Portofino Desk

Collection: PORTOFINO

Width: 60 **Depth:** 30 **Height:** 30 **Weight:** 133 / 133 lbs **Cube:** 13.55

Materials: White Oak Solids and Veneers

Standard Finish: LINEN **Country:** CHINA

Linen Finish. Two Pencil Drawers on left and right side. One Center Drawer with drop down drawer front. Cord Management. Also available in any Monogram Finish as M001-81

8001-84 — Price: \$3177

Portofino Lateral File

Collection: PORTOFINO

Width: 47 **Depth:** 22 **Height:** 33 **Weight:** 143 / 143 lbs **Cube:** 21.48

Materials: White Oak Solids and Veneers

Standard Finish: LINEN **Country:** CHINA

Linen Finish. Two Locking File drawers. Also available in any Monogram Finish as M001-84

8003-CS — Price: \$1197

Sequoia Chairside Table

Collection: SEQUOIA

Width: 22 **Depth:** 18 **Height:** 25.5 **Weight:** 51 / 51 lbs **Cube:** 9.7

Materials: Burl Veneer, Metal Accents

Standard Finish: N/A **Country:** INDIA

Features Brushed Gold metal ferrule on bottom of legs.

8003-ET — Price: \$2037

Sequoia End Table

Collection: SEQUOIA

Width: 32 **Depth:** 18 **Height:** 28 **Weight:** 71 / 71 lbs **Cube:** 15

Materials: Burl Veneer, Metal Accents

Standard Finish: N/A **Country:** INDIA

Features one drawer with Brush Gold hardware pull.

8003-13 — Price: \$2697

Sequoia Round Cocktail Table

Collection: SEQUOIA

Width: 40 **Depth:** 40 **Height:** 16.5 **Weight:** 82 / 82 lbs **Cube:** 15.27

Materials: Burl Veneer

Standard Finish: N/A **Country:** INDIA

Features Brushed Gold Metal door pulls and frame. White Carrera inset stone top. One interior drawer and one adjustable shelf.

8003-47 — Price: \$2037**Sequoia Oval End Table**

Collection: SEQUOIA

Width: 32 Depth: 18 Height: 28 Weight: 61 / 61 lbs Cube: 15

Materials: Burl Veneer, Metal Accents

Standard Finish: N/A **Country:** INDIA

Features one drawer with Brush Gold hardware pull.

8003-92 — Price: \$2397**Sequoia Square Cocktail Table**

Collection: SEQUOIA

Width: 40 Depth: 40 Height: 16.25 Weight: 120 / 120 lbs Cube: 22.4

Materials: Burl Veneer, Metal Accents

Standard Finish: N/A **Country:** INDIA

Features Brushed Gold metal ferrule on bottom of legs.

8003-99 — Price: \$2097**Sequoia Sofa Table**

Collection: SEQUOIA

Width: 60 Depth: 14 Height: 32.5 Weight: 79 / 79 lbs Cube: 15.79

Materials: Burl Veneer, Metal Accents

Standard Finish: N/A **Country:** INDIA

Features Brushed Gold metal ferrule on bottom of legs.

8005-BT — Price: \$987**Tulip Bar Height Table Base**

Collection: MASSIMO

Width: 20 Depth: 20 Height: 39 Weight: 62 / 62 lbs Cube: 9.02

Materials: Metal

Standard Finish: Blanca **Country:** CHINA**8005-CB — Price:** \$987**Tulip Counter Height Table Base**

Collection: MASSIMO

Width: 20 Depth: 20 Height: 35 Weight: 55 / 55 lbs Cube: 8.1

Materials: Metal

Standard Finish: Blanca **Country:** CHINA**8005-16 — Price:** \$1047**Tulip Dining Height Table Base**

Collection: MASSIMO, LIVE EDGE

Width: 20 Depth: 20 Height: 28 Weight: 79 / 79 lbs Cube: 9.79

Materials: Metal

Standard Finish: Blanca **Country:** CHINA

Features Adjustable levelers. This style is sold as one base. When pairing with rectangular Live Edge tops, two bases are required.

8005-26 — Price: \$897**Carrara Marble 26" Diameter Table top with Pencil Edge**

Collection: MASSIMO

Width: 26 Depth: 26 Height: 2 Weight: 68 / 68 lbs Cube: 0.78

Materials: White Carrara Marble

Standard Finish: Blanca **Country:** CHINA

Features a pencil edge.

8005-36 — Price: \$1197**Carrara Marble 36" Round Table Top**

Collection: MASSIMO

Width: 36 Depth: 36 Height: 2 Weight: 92 / 92 lbs Cube: 3.79

Materials: White Carrara Marble

Standard Finish: N/A **Country:** CHINA

Features a Pencil Edge Detail.

8005-46 — Price: \$987**Tulip Cocktail Height Table Base**

Collection: MASSIMO

Width: 20.5 Depth: 20.5 Height: 19 Weight: 71 / 71 lbs Cube: 4.62

Materials: Metal

Standard Finish: Blanca **Country:** CHINA

Features Adjustable levelers. Blanca finish

8005-48 — Price: \$2187**Carrara Marble 48" Round Table Top**

Collection: MASSIMO

Width: 48 Depth: 48 Height: 2 Weight: 154 / 154 lbs Cube: 6.38

Materials: White Carrara Marble

Standard Finish: N/A **Country:** CHINA

Features a Pencil Edge Detail.

8005-54 — Price: \$1497**Carrara Marble 54" Oval Table Top**

Collection: MASSIMO

Width: 54 Depth: 28 Height: 2 Weight: 99 / 99 lbs Cube: 4.43

Materials: White Carrara Marble

Standard Finish: N/A **Country:** CHINA

Features a Pencil Edge Detail.

8006-BT — Price: \$987**Tulip Bar Height Table Base**

Collection: MASSIMO

Width: 20 Depth: 20 Height: 39 Weight: 62 / 62 lbs Cube: 9.02

Materials: Metal

Standard Finish: Black **Country:** CHINA

8006-CB — Price: \$987**Standard Finish:** Black **Country:** CHINA**Tulip Counter Height Table Base****Collection:** MASSIMO**Width:** 20 **Depth:** 20 **Height:** 35 **Weight:** 55 / 55 lbs **Cube:** 8.1**Materials:** Metal**8006-16 — Price:** \$1047**Standard Finish:** Black **Country:** CHINA**Tulip Dining Height Table Base****Collection:** MASSIMO, LIVE EDGE**Width:** 20 **Depth:** 20 **Height:** 28 **Weight:** 79 / 79 lbs **Cube:** 9.79**Materials:** Metal

Features Adjustable levelers. This style is sold as one base. When pairing with rectangular Live Edge tops, two bases are required.

8006-46 — Price: \$987**Standard Finish:** Black **Country:** CHINA**Tulip Cocktail Height Table Base****Collection:** MASSIMO**Width:** 20.5 **Depth:** 20.5 **Height:** 19 **Weight:** 71 / 71 lbs **Cube:** 4.62**Materials:** Metal

Features Adjustable levelers. Oro finish

8007-86-2 — Price: \$1197**Standard Finish:** Nickel **Country:** CHINA**Beverly Activity Table****Collection:****Width:** 38 **Depth:** 38 **Height:** 30 **Weight:** 57 / 57 lbs **Cube:** 25.06**Materials:**

Upholstered in faux-leather 3109 Flax. 1,500,000 Double Rubs. W Cleaning Code- water based cleaner.

8007-86-6 — Price: \$1197**Standard Finish:** BRUSHED BRASS **Country:** CHINA**Beverly Activity Table****Collection:****Width:** 38 **Depth:** 38 **Height:** 30 **Weight:** 57 / 57 lbs **Cube:** 25.06**Materials:**

Upholstered in faux-leather 3109 Flax. 1,500,000 Double Rubs. W Cleaning Code- water based cleaner.

8009-86 — Price: \$1947**Standard Finish:** Hazelnut **Country:** CHINA**Oscar Activity Table****Collection:****Width:** 38 **Depth:** 38 **Height:** 30 **Weight:** 53 / 53 lbs **Cube:** 25.06**Materials:** Walnut Solids and Veneers

Features a lift off top with the reverse side to be used as a chess board. Beneath the lift off top, an inset backgammon board is available. Pull out drink holders are on each side of the table.

8011-88 — Price: \$807**Standard Finish:** Gold **Country:** CHINA**Lindsay Drink Table****Collection:****Width:** 14 **Depth:** 14 **Height:** 26 **Weight:** 27 / 27 lbs **Cube:** 3.52**Materials:** Metal Frame, Acrylic

Metal base in a gold finish and an acrylic top.

8014-88 — Price: \$867**Standard Finish:** Aged Bronze **Country:** CHINA**Belfort Drink Table****Collection:****Width:** 11 **Depth:** 11 **Height:** 23 **Weight:** 15 / 15 lbs **Cube:** 2.63**Materials:** Metal Frame

Intricately shaped metal base finished in Aged Brass with a marble top.

8016-CH — Price: \$2097**Standard Finish:** N/A **Country:** INDIA**Ashbury Chest****Collection:****Width:** 50 **Depth:** 19 **Height:** 38 **Weight:** 137 / 137 lbs **Cube:** 20.89**Materials:** Mango Solids

Features two adjustable shelves behind each door, vented back panel and black satin door hardware

8016-13 — Price: \$2697**Standard Finish:** N/A **Country:** INDIA**Ashbury Round Cocktail Table****Collection:****Width:** 52 **Depth:** 52 **Height:** 19 **Weight:** 216 / 216 lbs **Cube:** 29.73**Materials:** Mango Solids, White Carrara Marble

Features an inset white carrara stone top

8016-46 — Price: \$2397**Standard Finish:** N/A **Country:** INDIA**Ashbury Oval Cocktail Table****Collection:****Width:** 52 **Depth:** 34 **Height:** 19 **Weight:** 148 / 148 lbs **Cube:** 19.43**Materials:** Mango Solids, White Carrara Marble

Features an inset white carrara stone top

8031-88 — Price: \$687**Standard Finish:** N/A **Country:** INDIA**Cosmotini Drink Table****Collection:** SUNDRIES**Width:** 20 **Depth:** 20 **Height:** 22 **Weight:** 38 / 38 lbs **Cube:** 5.27**Materials:** Carrara Marble and Metal

8033-88 — Price: \$387

Standard Finish: N/A **Country:** INDIA

French 75 Drink Table

Collection: SUNDRIES

Width: 12 **Depth:** 12 **Height:** 24 **Weight:** 12 / 12 lbs **Cube:** 2

Materials: Metal and Antique Glass

8036-28 — Price: \$687

Standard Finish: N/A **Country:** INDIA

Ashbury Drink Table

Collection:

Width: 16 **Depth:** 16 **Height:** 18 **Weight:** 26 / 26 lbs **Cube:** 2.66

Materials: Mango Solids

8037-CK — Price: \$1137

Standard Finish: Modern Truffle **Country:** CHINA
Also available in any Monogram Finish as M037-CK

Kendrick Cocktail Table

Collection:

Width: 48 **Depth:** 26 **Height:** 18 **Weight:** 58 / 58 lbs **Cube:** 13

Materials: Red Oak Solids and Veneers

8037-CS — Price: \$747

Standard Finish: Modern Truffle **Country:** CHINA
Also available in any Monogram Finish as M037-CS

Kendrick Lamp Table

Collection:

Width: 26 **Depth:** 26 **Height:** 25 **Weight:** 20 / 20 lbs **Cube:** 9.78

Materials: Red Oak Solids and Veneers

8037-HT — Price: \$1197

Standard Finish: Modern Truffle **Country:** CHINA
Also available in any Monogram Finish as M037-HT

Kendrick Console Table

Collection:

Width: 56 **Depth:** 13.5 **Height:** 34 **Weight:** 30 / 30 lbs **Cube:** 14.87

Materials: Red Oak Solids and Veneers

8037-95 — Price: \$687

Standard Finish: Modern Truffle **Country:** CHINA
Also available in any Monogram Finish as M037-95

Kendrick End Table

Collection:

Width: 20 **Depth:** 26 **Height:** 25 **Weight:** 16 / 16 lbs **Cube:** 7.52

Materials: Red Oak Solids and Veneers

8050-20 — Price: \$2277

Standard Finish: Heirloom **Country:** CHINA
Features a hand-tufted seat married in 1119 Chestnut leather and finished in Heirloom.

Heirloom Cocktail Ottoman

Collection: HEIRLOOM

Width: 42 **Depth:** 42 **Height:** 20.5 **Weight:** 90 / 90 lbs **Cube:** 16.71

Materials: Birch Solids & Veneers

8050-94 — Price: \$897

Standard Finish: Heirloom **Country:** CHINA
Finished in Heirloom with cast zinc hardware and one drawer.

Heirloom Square End Table

Collection: HEIRLOOM

Width: 26 **Depth:** 26 **Height:** 25 **Weight:** 45 / 45 lbs **Cube:** 4.24

Materials: Birch Solids & Veneers

8052-MC — Price: \$3837

Standard Finish: N/A **Country:** INDIA
Features three storage areas with a shelf, USB ports, standard outlets, and cord exit holes.

Sundries Palm Leaf Credenza

Collection: SUNDRIES

Width: 79 **Depth:** 19 **Height:** 30 **Weight:** 195 / 195 lbs **Cube:** 31.47

Materials: Mango Solids,Solid Iron

8053-MC — Price: \$3447

Standard Finish: N/A **Country:** INDIA
Features three storage areas with a shelf, USB ports, standard outlets, and cord exit holes.

Sundries Naturale' Credenza

Collection: SUNDRIES

Width: 70 **Depth:** 18 **Height:** 34 **Weight:** 243 / 243 lbs **Cube:** 30.88

Materials: Acacia Solids,Solid Iron

8054-MC — Price: \$3147

Standard Finish: N/A **Country:** INDIA
Features three storage areas with a shelf, USB ports, standard outlets, and cord exit holes.

Sundries Desert Storm Credenza

Collection: SUNDRIES

Width: 60 **Depth:** 16 **Height:** 30 **Weight:** 195 / 195 lbs **Cube:** 20.7

Materials: Acacia Solids & Sandstone Veneers,Solid Iron

8063-BT — Price: \$1977

Standard Finish: Burnished Oak **Country:** CHINA

Arcadian Round Bistro Table

Collection: ARCADIAN

Width: 36 **Depth:** 36 **Height:** 36 **Weight:** 72 / 72 lbs **Cube:** 14.3

Materials: White Oak Solids & Veneers,Metal

8063-DT — Price: \$4107**Arcadian Farmhouse Draw Leaf Dining Table**

Collection: ARCADIAN

Width: 49 Depth: 30 Height: 31 Weight: 183 / 183 lbs Cube: 18.45

Materials: White Oak Solids & Veneers

Standard Finish: Burnished Oak **Country:** CHINA

A classic farmhouse draw table finished in Burnished Oak and featuring two, self-storing leaves.

8063-ET — Price: \$1617**Arcadian Rectangular End Table**

Collection: ARCADIAN

Width: 18 Depth: 28 Height: 27 Weight: 84 / 84 lbs Cube: 10.94

Materials: White Oak Solids & Veneers, Carrara Marble

Standard Finish: Burnished Oak **Country:** CHINA

Features an inset Carrara marble top with one fixed shelf. Finished in Burnished Oak.

8063-FT — Price: \$1977**Arcadian Flip-Top Console Table**

Collection: ARCADIAN

Width: 60 Depth: 16 Height: 30 Weight: 79 / 79 lbs Cube: 16.66

Materials: White Oak Solids & Veneers

Standard Finish: Burnished Oak **Country:** CHINA

Features an expandable top with two attached leaves. Finished in Burnished Oak.

8063-HT — Price: \$2247**Arcadian Open Storage Console Table**

Collection: ARCADIAN

Width: 72 Depth: 16 Height: 36 Weight: 118 / 118 lbs Cube: 17.41

Materials: White Oak Solids & Veneers, Metal

Standard Finish: Burnished Oak **Country:** CHINA

Features an open storage console table with an X-frame metal base. Finished in Burnished Oak.

8063-LD — Price: \$2277**Arcadian Lateral File Deck**

Collection: ARCADIAN

Width: 44.75 Depth: 12.25 Height: 42 Weight: 49 / 49 lbs Cube: 18.75

Materials: White Oak Solids & Veneers, Metal

Standard Finish: Burnished Oak **Country:** CHINA

Finished in Burnished Oak with two inset glass shelves and adjustable LED lighting. Pairs with 8063-84 Arcadian Lateral File, includes mending plates for attachment to the Lateral File.

8063-MC — Price: \$4227**Arcadian Media Credenza**

Collection: ARCADIAN

Width: 84 Depth: 20 Height: 36 Weight: 273 / 273 lbs Cube: 35.99

Materials: White Oak Solids & Veneers

Standard Finish: Burnished Oak **Country:** CHINA

Features a raised platform for television mounting and media console storage. Features four drawers and two wooden framed glass sliding doors with a fixed shelf and cord exit holes. Finished in Burnished Oak.

8063-MF — Price: \$1497**Arcadian Mobile File**

Collection: ARCADIAN

Width: 15.5 Depth: 18 Height: 25.5 Weight: 97 / 97 lbs Cube: 7.2

Materials: White Oak Solids & Veneers

Standard Finish: Burnished Oak **Country:** CHINA

Features one standard top level drawer, one lateral file drawer, and one hidden drawer. Finished in Burnished Oak.

8063-ST — Price: \$2487**Arcadian Console**

Collection: ARCADIAN

Width: 72 Depth: 14 Height: 34 Weight: 104 / 104 lbs Cube: 11.09

Materials: White Oak Solids & Veneers, Metal

Standard Finish: Burnished Oak **Country:** CHINA

Lower Shelf with Metal Accents. Finished in Burnished Oak

8063-TB — Price: \$2427**Arcadian Single Pedestal Table Base**

Collection: ARCADIAN

Width: 26 Depth: 26 Height: 27.5 Weight: 67 / 67 lbs Cube: 12.86

Materials: White Oak Solids & Veneers

Standard Finish: Burnished Oak **Country:** CHINA

Turned pedestal wood table base finished in Burnished Oak. Pairs with 8063-48 and 8063-60, Arcadian 48" and 60" Round Dining Table Tops.

8063-17 — Price: \$2247**Arcadian Huntboard Console Table**

Collection: ARCADIAN

Width: 72 Depth: 18 Height: 36 Weight: 96 / 96 lbs Cube: 10.73

Materials: White Oak Solids & Veneers

Standard Finish: Burnished Oak **Country:** CHINA

Features two pull-out drawers and turned wooden legs. Finished in Burnished Oak.

8063-19 — Price: \$1077**Arcadian C-Ring End Table**

Collection: ARCADIAN

Width: 26 Depth: 26 Height: 24 Weight: 32 / 32 lbs Cube: 11.7

Materials: White Oak Solids & Veneers

Standard Finish: Burnished Oak **Country:** CHINA

Features a C-ring metal base finished in black with a round wood top finished in Burnished Oak.

8063-43 — Price: \$5997**Arcadian Dining Table**

Collection: ARCADIAN

Width: 84 Depth: 42 Height: 30.75 Weight: 287 / 287 lbs Cube: 25.86

Materials: White Oak Solids & Veneers

Standard Finish: Burnished Oak **Country:** CHINA

Finished in Burnished Oak. Features one 22" leaf. Width with 22" leaf is 106" and without leaf is 84".

8063-48 — Price: \$1137**Arcadian 48" Round Dining Table Top**

Collection: ARCADIAN

Width: 48 Depth: 48 Height: 2.5 Weight: 78 / 78 lbs Cube: 6.64

Materials: White Oak Solids & Veneers

Standard Finish: Burnished Oak **Country:** CHINA

Distressed 48" Round Dining Table Top finished in Burnished Oak. Pairs with 8063-TB Arcadian Single Pedestal Table Base.

8063-60 — Price: \$1887**Arcadian 60" Round Dining Table Top**

Collection: ARCADIAN

Width: 60 Depth: 60 Height: 2.5 Weight: 97 / 97 lbs Cube: 10.17

Materials: White Oak Solids & Veneers

Standard Finish: Burnished Oak **Country:** CHINA

Distressed 60" Round Dining Table Top finished in Burnished Oak. Pairs with 8063-TB Arcadian Single Pedestal Table Base.

8063-81 — Price: \$2097**Arcadian Writing Desk**

Collection: ARCADIAN

Width: 60 Depth: 29.75 Height: 30 Weight: 154 / 154 lbs Cube: 10.33

Materials: White Oak Solids & Veneers

Standard Finish: Burnished Oak **Country:** CHINA

Finished in Burnished Oak with black metal accents and one drawer with a pencil tray.

8063-82 — Price: \$4257**Arcadian Sliding Glass Door Credenza**

Collection: ARCADIAN

Width: 78.5 Depth: 19 Height: 36 Weight: 154 / 154 lbs Cube: 39.76

Materials: White Oak Solids & Veneers

Standard Finish: Burnished Oak **Country:** CHINA

Finished in Burnished Oak with a contrasting white interior. Two storage areas behind sliding glass doors with adjustable shelves feature adjustable LED lighting for ambiance. Pairs with 8063-83 Arcadian Sliding Glass Door Deck.

8063-83 — Price: \$4287**Arcadian Sliding Glass Door Deck**

Collection: ARCADIAN

Width: 71.5 Depth: 16 Height: 46 Weight: 216 / 216 lbs Cube: 39.2

Materials: White Oak Solids & Veneers

Standard Finish: Burnished Oak **Country:** CHINA

Finished in Burnished Oak with a contrasting white interior. Two storage areas behind sliding glass doors with adjustable shelves feature adjustable LED lighting for ambiance. Pairs with 8063-82 Arcadian Sliding Glass Door Credenza.

8063-84 — Price: \$3447**Arcadian Lateral File**

Collection: ARCADIAN

Width: 47 Depth: 22 Height: 33 Weight: 191 / 191 lbs Cube: 25.3

Materials: White Oak Solids & Veneers

Standard Finish: Burnished Oak **Country:** CHINA

Two standard drawers and one lateral file drawer. Open storage area with a USB & Standard Outlet. Cord exit holes for equipment management.

8063-85 — Price: \$4287**Arcadian Etegere**

Collection: ARCADIAN

Width: 38 Depth: 16 Height: 84 Weight: 169 / 169 lbs Cube: 38.25

Materials: White Oak Solids & Veneers, Metal

Standard Finish: Burnished Oak **Country:** CHINA

Three Storage Shelves. Metal Accents. Finished in Burnished Oak

8063-90 — Price: \$1107**Arcadian Round Pedestal End Table**

Collection: ARCADIAN

Width: 28 Depth: 28 Height: 28 Weight: 39 / 39 lbs Cube: 4.25

Materials: White Oak Solids & Veneers

Standard Finish: Burnished Oak **Country:** CHINA

Features a beautiful, turned wood pedestal base with three feet finished in Burnished Oak.

8063-92 — Price: \$2787**Arcadian Square Cocktail Table**

Collection: ARCADIAN

Width: 48 Depth: 48 Height: 19 Weight: 147 / 147 lbs Cube: 14.72

Materials: White Oak Solids & Veneers, Metal

Standard Finish: Burnished Oak **Country:** CHINA

Lower Shelf with Metal Accents. Finished In Burnished Oak

8063-93 — Price: \$2397**Arcadian Rectangular Cocktail Table**

Collection: ARCADIAN

Width: 54 Depth: 30 Height: 19 Weight: 108 / 108 lbs Cube: 12.42

Materials: White Oak Solids & Veneers, Metal

Standard Finish: Burnished Oak **Country:** CHINA

Lower Shelf with Metal Accents. Finished in Burnished Oak

8063-94 — Price: \$1647**Arcadian Square End Table**

Collection: ARCADIAN

Width: 28 Depth: 28 Height: 26 Weight: 74 / 74 lbs Cube: 7.76

Materials: White Oak Solids & Veneers, Metal

Standard Finish: Burnished Oak **Country:** CHINA

Lower Shelf with Metal Accents. Finished In Burnished Oak

8063-95 — Price: \$1497**Arcadian Rectangular End Table**

Collection: ARCADIAN

Width: 18 Depth: 28 Height: 26 Weight: 56 / 56 lbs Cube: 5.28

Materials: White Oak Solids & Veneers, Metal

Standard Finish: Burnished Oak **Country:** CHINA

Lower Shelf with Metal Accents. Finished in Burnished Oak

CASEGOODS

8063-96 — Price: \$1767

Arcadian Narrow Console Table

Collection: ARCADIAN

Width: 60 **Depth:** 12 **Height:** 35 **Weight:** 92 / 92 lbs **Cube:** 6.83

Materials: White Oak Solids & Veneers

Standard Finish: Burnished Oak **Country:** CHINA

Features two drawers located on each end of the console and a stationary shelf at the base. Finished in Burnished Oak.

8063-97 — Price: \$2457

Arcadian Five Drawer Chest

Collection: ARCADIAN

Width: 44 **Depth:** 18 **Height:** 36 **Weight:** 129 / 129 lbs **Cube:** 19.77

Materials: White Oak Solids & Veneers

Standard Finish: Burnished Oak **Country:** CHINA

Finished in Burnished Oak with five drawers.

8063-98 — Price: \$2457

Arcadian Drum End Table

Collection: ARCADIAN

Width: 28 **Depth:** 28 **Height:** 24 **Weight:** 115 / 115 lbs **Cube:** 14.8

Materials: White Oak Solids & Veneers, Carrara Marble

Standard Finish: Burnished Oak **Country:** CHINA

Finished in Burnished Oak with a white Carrara marble and one interior shelf behind a door.

8063-99 — Price: \$2487

Arcadian Counter Height Console Table

Collection: ARCADIAN

Width: 68 **Depth:** 18 **Height:** 36 **Weight:** 132 / 132 lbs **Cube:** 9.56

Materials: White Oak Solids & Veneers, Carrara Marble

Standard Finish: Burnished Oak **Country:** CHINA

Counter height console table finished in Burnished Oak with a white Carrara marble top. Designed with an open end sized appropriately for two counter stools.

8065-BT — Price: \$1377

Highland Ridge Bistro Table

Collection:

Width: 36 **Depth:** 36 **Height:** 36 **Weight:** 80 / 80 lbs **Cube:** 7.16

Materials:

Standard Finish: brushed linen **Country:** CHINA

8065-89 — Price: \$1437

Highland Ridge Drop Leaf Table

Collection:

Width: 36 **Depth:** 14 **Height:** 30 **Weight:** 55 / 55 lbs **Cube:** 9.98

Materials:

Standard Finish: brushed linen **Country:** CHINA

8066-ST — Price: \$2547

Coeur d'Alene Console Table

Collection: COEUR D'ALENE

Width: 84 **Depth:** 18 **Height:** 34 **Weight:** 144 / 144 lbs **Cube:** 14.95

Materials: Red Oak Solids & Veneers

Standard Finish: Reclaimed Oak **Country:** CHINA

Finished in Reclaimed Oak.

8066-99 — Price: \$3177

Coeur d'Alene Console Table

Collection: COEUR D'ALENE

Width: 72 **Depth:** 16 **Height:** 32 **Weight:** 154 / 154 lbs **Cube:** 29.7

Materials: Red Oak Solids & Veneers

Standard Finish: Reclaimed Oak **Country:** CHINA

Large, circular design elements create a sculptural silhouette, finished in Reclaimed Oak. Also available in any Monogram Finish as M066-99.

8067-TB — Price: \$2637

Serpentine Shaped Leg Dining Pedestal Base

Collection:

Width: 36 **Depth:** 36 **Height:** 28.5 **Weight:** 52 / 52 lbs **Cube:** 26.32

Materials: Walnut Solids & Veneers

Standard Finish: Sheer Dove **Country:** CHINA

Finished in Sheer Dove with Nickel ferrules. Pairs with 8067-60 and 8067-48, Beveled Edge 48 and 60" Dining Table Tops. Also available in any Monogram Finish as M067-TB.

8067-48 — Price: \$1347

Beveled Edge 48" Dining Table Top

Collection:

Width: 48 **Depth:** 48 **Height:** 1 **Weight:** 68 / 68 lbs **Cube:** 6.13

Materials: Walnut Solids & Veneers

Standard Finish: Sheer Dove **Country:** CHINA

Finished in Sheer Dove with a pie-shaped veneer design. Pairs with 8067-TB Serpentine Shaped Leg Dining Pedestal Base. Also available in any Monogram Finish as M067-48.

8067-60 — Price: \$1827

Beveled Edge 60" Dining Table Top

Collection:

Width: 60 **Depth:** 60 **Height:** 1 **Weight:** 98 / 98 lbs **Cube:** 8.61

Materials: Walnut Solids & Veneers

Standard Finish: Sheer Dove **Country:** CHINA

Finished in Sheer Dove with a pie-shaped veneer design. Pairs with 8067-TB Serpentine Shaped Leg Dining Pedestal Base. Also available in any Monogram Finish as M067-60.

8069-TB — Price: \$1797

C-Ring Pedestal Base

Collection:

Width: 32.5 **Depth:** 32.5 **Height:** 29 **Weight:** 50 / 50 lbs **Cube:** 22.33

Materials: Walnut Solids & Veneers

Standard Finish: Sheer Dove **Country:** CHINA

Finished in Sheer Dove with Nickel cap accents. Pairs with 8067-60 and 8067-48, Beveled Edge 48 and 60" Dining Table Tops. Also available in any Monogram Finish as M069-TB.

CASEGOODS

8080-ET-C — Price: \$1137

Helena Nesting Table

Collection:

Width: 22 Depth: 22 Height: 25 Weight: 21 / 21 lbs Cube: 7

Materials: White Oak Solids and Veneers

Standard Finish: Charcoal Country: CHINA

Also available in any Monogram Finish as M080-ET

8080-90-C — Price: \$1197

Helena End Table

Collection:

Width: 24 Depth: 24 Height: 24 Weight: 39 / 39 lbs Cube: 8

Materials: White Oak Solids and Veneers

Standard Finish: Charcoal Country: CHINA

Also available in any Monogram Finish as M080-90

8080-99-C — Price: \$1497

Helena Console Table

Collection:

Width: 52 Depth: 18 Height: 34 Weight: 83 / 83 lbs Cube: 18.41

Materials: White Oak Solids and Veneers

Standard Finish: Charcoal Country: CHINA

Also available in any Monogram Finish as M080-99

8081-10 — Price: \$1737

Sundries Bench

Collection: SUNDRIES

Width: 53 Depth: 19 Height: 19 Weight: 40 / 40 lbs Cube: 16.33

Materials: Mango Solids

Standard Finish: Ochre Country: INDIA

Finished in Ochre with Jute webbed seating and a metal stretcher. Features natural cane accents that was handwoven using the peel of natural rattan. As with any natural product, nature's imperfections and hallmarks will be present in the cane materials. Cane is a handcrafted product dating back to the Ancient Egyptians.

8084-CH — Price: \$2727

Lizzie Coeur d'Alene Chest

Collection: COEUR D'ALENE

Width: 43 Depth: 23 Height: 38 Weight: 68 / 68 lbs Cube: 28.37

Materials: Maple Solids & Veneers

Standard Finish: Flint Country: CHINA

Finished in Flint with antique brass hardware and four drawers. Also available in any Monogram Finish as M084-CH.

8092-DT — Price: \$5937

Cheñeais Dining Table

Collection: CHEÑEAIS

Width: 90 Depth: 46 Height: 30 Weight: 487 / 487 lbs Cube: 82.18

Materials: Select Red Oak Solids & Veneers

Standard Finish: French Oak Country: CHINA

Finished in French Oak. Width with one 22" leaf is 112" and with two 22" leaves is 134". Consists of 8092-DT-B (Base) and 8092-DT-T (Top). Also available in any Monogram Finish as M092-DT.

8092-17 — Price: \$6447

Cheñeais Credenza

Collection: CHEÑEAIS

Width: 84 Depth: 19 Height: 38 Weight: 351 / 351 lbs Cube: 48.05

Materials: Select Red Oak Solids & Veneers

Standard Finish: French Oak Country: CHINA

Finished in French Oak with inset stone top, three doors, two drawers, and four interior adjustable shelves. Hardware finished in Oiled Antique Bronze. Also available in any Monogram Finish as M092-17.

8092-19 — Price: \$1857

Cheñeais End Table

Collection: CHEÑEAIS

Width: 25 Depth: 25 Height: 25 Weight: 64 / 64 lbs Cube: 13.36

Materials: Select Red Oak Solids & Veneers

Standard Finish: French Oak Country: CHINA

Finished in French Oak with inset stone top and one fixed shelf. Also available in any Monogram Finish as M092-19

8092-92 — Price: \$3207

Cheñeais Square Cocktail Table

Collection: CHEÑEAIS

Width: 48 Depth: 48 Height: 20 Weight: 175 / 175 lbs Cube: 34.61

Materials: Select Red Oak Solids

Standard Finish: French Oak Country: CHINA

Finished in French Oak with an inset glass top and decorative metal stretcher. Also available in any Monogram Finish as M092-92

8092-98 — Price: \$1197

Cheñeais Round Lamp Table

Collection: CHEÑEAIS

Width: 25 Depth: 25 Height: 26 Weight: 56 / 56 lbs Cube: 14.57

Materials: Select Red Oak Solids & Veneers

Standard Finish: French Oak Country: CHINA

Finished in French Oak with one fixed shelf. Also available in any Monogram Finish as M092-98

8096-AD — Price: \$2697

West Camden Writing Desk

Collection: WEST CAMDEN

Width: 58 Depth: 28 Height: 30 Weight: 172 / 172 lbs Cube: 21.62

Materials: Metal, Walnut Solids and Veneers

Standard Finish: TAHITIAN PEARL Country: CHINA

Features four soft close drawers. One pencil tray and hidden storage compartment. Finished in Tahitian Pearl with Black Steel accents.

8096-CS — Price: \$867

West Camden End Table

Collection: WEST CAMDEN

Width: 16 Depth: 28 Height: 24 Weight: 46 / 46 lbs Cube: 9.12

Materials: Walnut Solids and Veneers

Standard Finish: TAHITIAN PEARL Country: CHINA

Finished in Tahitian Pearl with one pull-out shelf and two fixed shelves. Also available in any Monogram Finish as M096-CS

8096-CT — Price: \$1437**West Camden Round Cocktail Table**

Collection: WEST CAMDEN

Width: 44 Depth: 44 Height: 19 Weight: 81 / 81 lbs Cube: 8.22

Materials: Metal, Walnut Solids and Veneers

Standard Finish: TAHITIAN PEARL **Country:** CHINA

Finished in Tahitian Pearl with Black Steel accents. Also available in any Monogram Finish as M096-CT

8096-DT — Price: \$3897**West Camden Round Dining Table**

Collection: WEST CAMDEN

Width: 72 Depth: 72 Height: 30 Weight: 272 / 272 lbs Cube: 0

Materials: Walnut Solids and Veneers

Standard Finish: TAHITIAN PEARL **Country:** CHINA

72" round dining table top finished in Tahitian Pearl. Consist of 8096-DT-B (Base) and 8096-DT-T (Top). Also available in any Monogram Finish as M096-DT.

8096-ET — Price: \$897**West Camden End Table**

Collection: WEST CAMDEN

Width: 22 Depth: 22 Height: 24 Weight: 35 / 35 lbs Cube: 9.74

Materials: Metal, Walnut Solids and Veneers

Standard Finish: TAHITIAN PEARL **Country:** CHINA

Tray top finished in Tahitian Pearl with Black Steel metal base. Also available in any Monogram Finish as M096-ET

8096-HT — Price: \$987**West Camden Console Table**

Collection: WEST CAMDEN

Width: 46 Depth: 14 Height: 34 Weight: 45 / 45 lbs Cube: 5.14

Materials: Walnut Solids and Veneers

Standard Finish: TAHITIAN PEARL **Country:** CHINA

Tray top finished in Tahitian Pearl with Black Steel metal base. Also available in any Monogram Finish as M096-HT

8096-MF — Price: \$1047**West Camden Mobile File**

Collection: WEST CAMDEN

Width: 17.5 Depth: 18 Height: 23.5 Weight: 91 / 91 lbs Cube: 4.28

Materials: Walnut Solids and Veneers

Standard Finish: TAHITIAN PEARL **Country:** CHINA

Finished in Tahitian Pearl with Black Steel finished hardware and scallop-carved drawer fronts. Features hidden casters with one standard top drawer and one bottom lateral file drawer with a hidden pencil drawer. Fits under the 8096-81 West Camden Writing Desk.

8096-ST — Price: \$2397**West Camden Three Drawer Console**

Collection: WEST CAMDEN

Width: 72 Depth: 16 Height: 34 Weight: 145 / 145 lbs Cube: 11.48

Materials: Walnut Solids and Veneers, Stone

Standard Finish: TAHITIAN PEARL **Country:** CHINA

Features Three finger pull, soft close drawers and a White Carrara stone top in Tahitian Pearl Finish. Also available in any Monogram Finish as M096-ST

8096-16 — Price: \$1647**West Camden Dining Table Base**

Collection: WEST CAMDEN

Width: 30 Depth: 30 Height: 29.5 Weight: 67 / 67 lbs Cube: 18.08

Materials: Metal, Walnut Solids and Veneers

Standard Finish: TAHITIAN PEARL **Country:** CHINA

Black Steel metal with wood base in Tahitian Pearl Finish. Pairs with GLAS-54 54" Glass Top and GLAS-60 60" Glass Top. Also available in any Monogram Finish as M096-16.

8096-19 — Price: \$897**West Camden Round End Table**

Collection: WEST CAMDEN

Width: 22 Depth: 22 Height: 24 Weight: 44 / 44 lbs Cube: 10.07

Materials: Metal, Walnut Solids and Veneers

Standard Finish: TAHITIAN PEARL **Country:** CHINA

Finished in Tahitian Pearl with Black Steel metal frame. Also available in any Monogram Finish as M096-19

8096-38 — Price: \$2007**West Camden Drawer Chest**

Collection: WEST CAMDEN

Width: 36 Depth: 20 Height: 32 Weight: 110 / 110 lbs Cube: 13.33

Materials: Metal, Walnut Solids and Veneers

Standard Finish: TAHITIAN PEARL **Country:** CHINA

Finished in Tahitian Pearl with Black Steel metal accents, and three self-closing drawers with scallop-carved fronts. Also available in any Monogram Finish as M096-38.

8096-44 — Price: \$3597**West Camden Dining Table**

Collection: WEST CAMDEN

Width: 60 Depth: 60 Height: 32 Weight: 262 / 262 lbs Cube: 17.65

Materials: Walnut Solids and Veneers

Standard Finish: TAHITIAN PEARL **Country:** CHINA

Features One 22" leaf. Finished in Tahitian Pearl Finish. Consists of 8096-44-T top & 8096-44-B base. Also available in any Monogram Finish as M096-44.

8096-81 — Price: \$1767**West Camden Writing Desk**

Collection: WEST CAMDEN

Width: 58 Depth: 30 Height: 30 Weight: 130 / 130 lbs Cube: 11.31

Materials: Metal, Walnut Solids and Veneers

Standard Finish: TAHITIAN PEARL **Country:** CHINA

Finished in Tahitian Pearl with Black Steel metal accents and three soft-close drawers. Sized to pair with 8096-MF West Camden Mobile File.

8096-82 — Price: \$3897**West Camden Credenza**

Collection: WEST CAMDEN

Width: 78 Depth: 20 Height: 34 Weight: 293 / 293 lbs Cube: 30.69

Materials: Walnut Solids and Veneers

Standard Finish: TAHITIAN PEARL **Country:** CHINA

Features Four doors with an adjustable shelf behind each door. Black Steel hardware. Also available in any Monogram Finish as M096-82.

8096-83 — Price: \$2697**West Camden Lateral File Deck**

Collection: WEST CAMDEN

Width: 45.5 Depth: 14.25 Height: 45.75 Weight: 140 / 140 lbs Cube: 17.16

Materials: Metal, Walnut Solids and Veneers

Standard Finish: TAHITIAN PEARL **Country:** CHINA

Finished in Tahitian Pearl with oval, Black Steel metal accents on the end panels and three-way adjustable touch lighting with three adjustable glass shelves.

8096-84 — Price: \$2997**West Camden Lateral File Cabinet**

Collection: WEST CAMDEN

Width: 47.5 Depth: 20 Height: 33 Weight: 176 / 176 lbs Cube: 18.14

Materials: Metal, Walnut Solids and Veneers

Standard Finish: TAHITIAN PEARL **Country:** CHINA

Finished in Tahitian Pearl with Black Steel hardware and scallop-carved drawer and door fronts. Two doors with interior storage housing adjustable shelves, standard outlet with a dual USB port, and cord exit holes. Two bottom lateral file drawers. Use alone or pair with 8096-83, West Camden Deck.

8096-86 — Price: \$2037**West Camden Center Hall Table**

Collection: WEST CAMDEN

Width: 38 Depth: 38 Height: 30 Weight: 133 / 133 lbs Cube: 0

Materials: Walnut Solids and Veneers

Standard Finish: TAHITIAN PEARL **Country:** CHINA

Finished in Tahitian Pearl with Black Steel metal accents Pairs with 8096-86-B, West Camden Base.

8096-93 — Price: \$1047**West Camden Rectangular Cocktail Table**

Collection: WEST CAMDEN

Width: 42 Depth: 20 Height: 18 Weight: 45 / 45 lbs Cube: 4.67

Materials: Metal, Walnut Solids and Veneers

Standard Finish: TAHITIAN PEARL **Country:** CHINA

Tray top finished in Tahitian Pearl with Black Steel metal base. Also available in any Monogram Finish as M096-93

8096-94 — Price: \$627**West Camden Drink Table**

Collection: WEST CAMDEN

Width: 14 Depth: 14 Height: 22 Weight: 23 / 23 lbs Cube: 4.09

Materials: Metal, Walnut Solids and Veneers

Standard Finish: TAHITIAN PEARL **Country:** CHINA

Tray top finished in Tahitian Pearl with Black Steel metal base. Also available in any Monogram Finish as M096-94

8096-96 — Price: \$3597**West Camden Credenza**

Collection: WEST CAMDEN

Width: 72 Depth: 20 Height: 34 Weight: 256 / 256 lbs Cube: 28.33

Materials: Metal, Walnut Solids and Veneers

Standard Finish: TAHITIAN PEARL **Country:** CHINA

Features two doors with two interior adjustable shelves. Finished in Tahitian Pearl with metal base and hardware in Black Steel. Also available in any Monogram Finish as M096-96.

8096-97 — Price: \$2697**West Camden Drawer Chest**

Collection: WEST CAMDEN

Width: 42 Depth: 20 Height: 40 Weight: 143 / 143 lbs Cube: 19.44

Materials: Metal, Walnut Solids and Veneers

Standard Finish: TAHITIAN PEARL **Country:** CHINA

Finished in Tahitian Pearl with acrylic and Black Steel hardware, five reed-ed-front drawers with self-closing drawer guides. Also available in any Monogram Finish as M096-97.

8096-98 — Price: \$1677**West Camden End Table**

Collection: WEST CAMDEN

Width: 28 Depth: 22 Height: 24 Weight: 60 / 60 lbs Cube: 8.55

Materials: Metal, Carrara Marble, & Glass

Standard Finish: N/A **Country:** CHINA

Finished in Tahitian Pearl with Black Steel accents, Carrara marble top, and one fixed glass shelf.

8098-AD — Price: \$2697**East Camden Writing Desk**

Collection: EAST CAMDEN

Width: 58 Depth: 28 Height: 30 Weight: 172 / 172 lbs Cube: 21.62

Materials: Metal, Poplar Solids & Veneers

Standard Finish: Pearl **Country:** CHINA

Features four soft close drawers. One pencil tray and hidden storage compartment. Finished in Pearl with Antique Brass accents.

8098-AT — Price: \$1077**East Camden Accent Table**

Collection: EAST CAMDEN

Width: 17 Depth: 17 Height: 22 Weight: 29 / 29 lbs Cube: 5.23

Materials: Metal & Carrara Marble

Standard Finish: Antique Brass **Country:** CHINA

Features a Carrara marble top with an Antique Brass metal base.

8098-BS — Price: \$1887**East Camden Night Stand**

Collection: EAST CAMDEN

Width: 36 Depth: 20 Height: 30 Weight: 157 / 157 lbs Cube: 12.5

Materials: Metal Accents, Poplar Solids and Veneers

Standard Finish: Pearl **Country:** CHINA

Features one drawer with Antique Brass hardware and Pearl Finish. All drawers feature full extension and self-closing hardware.

8098-CH — Price: \$2547**East Camden Chest**

Collection: EAST CAMDEN

Width: 44 Depth: 19 Height: 36 Weight: 132 / 132 lbs Cube: 22.59

Materials: Poplar Solids & Veneers

Standard Finish: Pearl **Country:** CHINA

Finished in Pearl with Antique Brass accents and three drawers with fluted fronts and self-closing drawer guides.

CASEGOODS

8098-CS — Price: \$927

East Camden Chairside Table

Collection: EAST CAMDEN

Width: 16 Depth: 28 Height: 24 Weight: 46 / 46 lbs Cube: 8.95

Materials: Poplar Solids & Veneers

Standard Finish: Pearl **Country:** CHINA

Finished in Pearl with one pull-out shelf and two fixed shelves.

8098-CT — Price: \$1437

East Camden Round Cocktail Table

Collection: EAST CAMDEN

Width: 44 Depth: 44 Height: 19 Weight: 81 / 81 lbs Cube: 8.22

Materials: Metal, Poplar Solids & Veneers

Standard Finish: Pearl **Country:** CHINA

Antique Brass metal

8098-DC — Price: \$2847

East Camden Chest

Collection: EAST CAMDEN

Width: 60 Depth: 20 Height: 38 Weight: 271 / 271 lbs Cube: 26.38

Materials: Metal Accents, Poplar Solids and Veneers

Standard Finish: Pearl **Country:** CHINA

Features six drawers with Antique Brass hardware and Pearl Finish. All drawers feature full extension and self-closing hardware.

8098-DK — Price: \$1947

East Camden Desk

Collection: EAST CAMDEN

Width: 42 Depth: 22 Height: 30 Weight: 79 / 79 lbs Cube: 16.04

Materials: Metal Accents, Poplar Solids and Veneers

Standard Finish: Pearl **Country:** CHINA

Features one drawer with Antique Brass hardware and Pearl Finish. All drawers feature full extension and self-closing hardware.

8098-DT — Price: \$4317

East Camden Scalloped Dining Table

Collection: EAST CAMDEN

Width: 72 Depth: 72 Height: 30 Weight: 234 / 234 lbs Cube: 37.13

Materials: Poplar Solids & Veneers

Standard Finish: Pearl **Country:** CHINA

72" round dining table top finished in Pearl. Consist of 8098-DT-B (Base) and 8098-DT-T (Top)

8098-ET — Price: \$897

East Camden End Table

Collection: EAST CAMDEN

Width: 22 Depth: 22 Height: 24 Weight: 35 / 35 lbs Cube: 9.74

Materials: Metal, Poplar Solids & Veneers

Standard Finish: Pearl **Country:** CHINA

Antique Brass metal

8098-HT — Price: \$987

East Camden Console Table

Collection: EAST CAMDEN

Width: 46 Depth: 14 Height: 34 Weight: 33 / 33 lbs Cube: 5.3

Materials: Poplar Solids & Veneers

Standard Finish: Pearl **Country:** CHINA

Antique Brass metal

8098-KB — Price: \$3747

East Camden King Bed

Collection: EAST CAMDEN

Width: 81 Depth: 88 Height: 70.75 Weight: 108 / 108 lbs Cube: 291.84

Materials: Metal Accents, Poplar Solids and Veneers

Standard Finish: Pearl **Country:** CHINA

Married in 3343-75 Ivory fabric and Pearl wood finish.

8098-MF — Price: \$1137

East Camden Mobile File

Collection: EAST CAMDEN

Width: 17.5 Depth: 18 Height: 23.5 Weight: 91 / 91 lbs Cube: 6.44

Materials: Poplar Solids & Veneers

Standard Finish: Pearl **Country:** CHINA

Finished in Pearl with Antique Brass hardware and scallop-carved drawer fronts. Features hidden casters with one standard top drawer and one bottom lateral file drawer with a hidden pencil drawer. Fits under the 8098-81 East Camden Writing Desk.

8098-MH — Price: \$2997

East Camden Chest

Collection: EAST CAMDEN

Width: 72 Depth: 18 Height: 38 Weight: 293 / 293 lbs Cube: 31.66

Materials: Metal Accents, Poplar Solids and Veneers

Standard Finish: Pearl **Country:** CHINA

Features eight drawers with Antique Brass hardware and Pearl Finish. All drawers feature full extension and self-closing hardware.

8098-QB — Price: \$3597

East Camden Queen Bed

Collection: EAST CAMDEN

Width: 81 Depth: 85 Height: 66 Weight: 98 / 98 lbs Cube: 262.96

Materials: Metal Accents, Poplar Solids and Veneers

Standard Finish: Pearl **Country:** CHINA

Married in 3343-75 Ivory fabric and Pearl wood finish.

8098-SB — Price: \$2247

East Camden Night Stand

Collection: EAST CAMDEN

Width: 32 Depth: 22 Height: 30 Weight: 119 / 119 lbs Cube: 12.22

Materials: Metal Accents, Poplar Solids and Veneers

Standard Finish: Pearl **Country:** CHINA

Features one drawer and one pull out tray. Metal base and hardware in Antique Brass finish. Pearl Finish. All drawers feature full extension and self-closing hardware.

CASEGOODS

8098-SC — Price: \$1947

East Camden Chest

Collection: EAST CAMDEN

Width: 38 **Depth:** 19 **Height:** 38 **Weight:** 172 / 172 lbs **Cube:** 15.87

Materials: Metal Accents, Poplar Solids and Veneers

Standard Finish: Pearl **Country:** CHINA

Features three drawers with Antique Brass hardware and Pearl Finish. All drawers feature full extension and self-closing hardware.

8098-ST — Price: \$2397

East Camden Three Drawer Console

Collection: EAST CAMDEN

Width: 72 **Depth:** 16 **Height:** 34 **Weight:** 160 / 160 lbs **Cube:** 22.66

Materials: Poplar Solids & Veneers, Stone

Standard Finish: Pearl **Country:** CHINA

Features Three finger pull, soft close drawers and a White Carrara stone top in Pearl Finish.

8098-TB — Price: \$1587

East Camden Dining Table Base

Collection: EAST CAMDEN

Width: 28 **Depth:** 28 **Height:** 28 **Weight:** 42 / 42 lbs **Cube:** 16.54

Materials: Metal Base

Standard Finish: Antique Brass **Country:** CHINA

Metal base finished in Antique Brass. Pairs with 8098-60 East Camden 60" Dining Table Top, GLAS-54 54" Glass Top and GLAS-60 60" Glass Top.

8098-08 — Price: \$1587

East Camden Vanity Desk

Collection: EAST CAMDEN

Width: 54.5 **Depth:** 28.5 **Height:** 30 **Weight:** 79 / 79 lbs **Cube:** 8.12

Materials: Metal, Poplar Solids & Veneers

Standard Finish: Pearl **Country:** CHINA

Finished in Pearl with Antique Brass ferrules, one drawer, and a fluted apron.

8098-13 — Price: \$2307

East Camden Round Cocktail Table

Collection: EAST CAMDEN

Width: 44 **Depth:** 44 **Height:** 18 **Weight:** 82 / 82 lbs **Cube:** 26.93

Materials: Metal, Poplar Solids & Veneers

Standard Finish: Pearl **Country:** CHINA

Antique Brass metal base and a wood top finished in Pearl with glass insert.

8098-16 — Price: \$1647

East Camden Dining Table Base

Collection: EAST CAMDEN

Width: 30 **Depth:** 30 **Height:** 29.5 **Weight:** 65 / 65 lbs **Cube:** 18.66

Materials: Metal, Poplar Solids & Veneers

Standard Finish: Pearl **Country:** CHINA

Antique Brass metal. Pairs with GLAS-54, 54" Glass Top and GLAS-60, 60" Glass Top.

8098-17 — Price: \$3957

East Camden Sideboard

Collection: EAST CAMDEN

Width: 74 **Depth:** 19 **Height:** 36 **Weight:** 213 / 213 lbs **Cube:** 38.41

Materials: Metal, Poplar Solids & Veneers

Standard Finish: Pearl **Country:** CHINA

Finished in Pearl with Antique Brass metal accents, rose gold mirrored door panels, and interior adjustable shelves.

8098-19 — Price: \$897

East Camden Round End Table

Collection: EAST CAMDEN

Width: 22 **Depth:** 22 **Height:** 24 **Weight:** 44 / 44 lbs **Cube:** 10.36

Materials: Metal, Poplar Solids & Veneers

Standard Finish: Pearl **Country:** CHINA

Finished in Pearl with Antique Brass metal frame

8098-38 — Price: \$2127

East Camden Chest

Collection: EAST CAMDEN

Width: 36 **Depth:** 20 **Height:** 32 **Weight:** 112 / 112 lbs **Cube:** 18.27

Materials: Metal, Poplar Solids & Veneers

Standard Finish: Pearl **Country:** CHINA

Finished in Pearl with Antique Brass metal accents, and three self-closing drawers with scallop-carved fronts. Also available in any Monogram Finish as M098-38.

8098-44 — Price: \$3597

East Camden Dining Table

Collection: EAST CAMDEN

Width: 60 **Depth:** 60 **Height:** 32 **Weight:** 260 / 260 lbs **Cube:** 18.18

Materials: Poplar Solids & Veneers

Standard Finish: Pearl **Country:** CHINA

Features One 22" leaf. Finished in Pearl Finish

8098-47 — Price: \$1557

East Camden Oval End Table

Collection: EAST CAMDEN

Width: 28 **Depth:** 18 **Height:** 25 **Weight:** 56 / 56 lbs **Cube:** 9.96

Materials: Metal & Italian Marble

Standard Finish: Pearl **Country:** CHINA

Carrara marble top and an Antique Brass metal base.

8098-48 — Price: \$3777

East Camden Bar Cabinet

Collection: EAST CAMDEN

Width: 41 **Depth:** 21 **Height:** 40 **Weight:** 96 / 96 lbs **Cube:** 27.37

Materials: Poplar Solids & Veneers

Standard Finish: Pearl **Country:** CHINA

Finished in Pearl with an inset Carrara marble top, two doors, and Antique Brass metal accents and hardware. Interior includes one fixed shelf, antique brass gallery, stem ware holder, storage for six wine bottles, and 4 door bin shelves.

8098-60 — Price: \$1317**East Camden Dining Table Top**

Collection: EAST CAMDEN

Width: 60 Depth: 60 Height: 2 Weight: 110 / 110 lbs Cube: 9.04

Materials: Poplar Solids & Veneers

Standard Finish: Pearl **Country:** CHINA

60" round dining table top finished in Pearl. Pairs with 8098-TB East Camden Dining Base.

8098-81 — Price: \$1947**East Camden Writing Desk**

Collection: EAST CAMDEN

Width: 58 Depth: 30 Height: 30 Weight: 141 / 141 lbs Cube: 11.9

Materials: Poplar Solids & Veneers

Standard Finish: Pearl **Country:** CHINA

Finished in Pearl with Antique Brass metal accents and three soft-close drawers. Sized to pair with 8098-MF East Camden Mobile File.

8098-82 — Price: \$3897**East Camden Credenza**

Collection: EAST CAMDEN

Width: 78 Depth: 20 Height: 34 Weight: 293 / 293 lbs Cube: 30.69

Materials: Walnut Solids and Veneers

Standard Finish: Pearl **Country:** CHINA

Features Four doors with an adjustable shelf behind each door. Antique Brass hardware

8098-83 — Price: \$2967**East Camden Deck**

Collection: EAST CAMDEN

Width: 45.5 Depth: 14.25 Height: 45.75 Weight: 140 / 140 lbs Cube: 25.28

Materials: Poplar Solids & Veneers, Antique Metal

Standard Finish: Pearl **Country:** CHINA

Finished in Pearl with oval, Antique Brass metal accents on the end panels and three-way adjustable touch lighting with three adjustable glass shelves.

8098-84 — Price: \$3297**East Camden Lateral File**

Collection: EAST CAMDEN

Width: 47.5 Depth: 20 Height: 33 Weight: 200 / 200 lbs Cube: 25.19

Materials: Poplar Solids & Veneers, Antique Metal

Standard Finish: Pearl **Country:** CHINA

Finished in Pearl with Antique Brass hardware and scallop-carved drawer and door fronts. Two doors with interior storage housing adjustable shelves, standard outlet with a dual USB port, and cord exit holes. Two bottom lateral file drawers. Use alone or pair with 8098-83, East Camden Deck.

8098-86 — Price: \$2037**East Camden Center Hall Table**

Collection: EAST CAMDEN

Width: 38 Depth: 38 Height: 30 Weight: 133 / 133 lbs Cube: 0

Materials: Poplar Solids & Veneers

Standard Finish: Pearl **Country:** CHINA

Finished in Pearl with Antique Brass metal accents Pairs with 8098-86-B, East Camden Base.

8098-88 — Price: \$747**East Camden Drink Table**

Collection: EAST CAMDEN

Width: 18 Depth: 18 Height: 26 Weight: 18 / 18 lbs Cube: 6.71

Materials: Metal & Glass

Standard Finish: Antique Brass **Country:** CHINA

Antique Brass metal base and an acid-etched mirrored top.

8098-93 — Price: \$1047**East Camden Rectangular Cocktail Table**

Collection: EAST CAMDEN

Width: 42 Depth: 20 Height: 18 Weight: 43 / 43 lbs Cube: 4.68

Materials: Metal, Poplar Solids & Veneers

Standard Finish: Pearl **Country:** CHINA

Tray top with Black Steel metal base.

8098-94 — Price: \$627**East Camden Drink Table**

Collection: EAST CAMDEN

Width: 14 Depth: 14 Height: 22 Weight: 23 / 23 lbs Cube: 1.61

Materials: Metal, Poplar Solids & Veneers

Standard Finish: Pearl **Country:** CHINA

Tray top with Black Steel metal base.

8098-96 — Price: \$3597**East Camden Credenza**

Collection: EAST CAMDEN

Width: 72 Depth: 20 Height: 34 Weight: 256 / 256 lbs Cube: 28.33

Materials: Metal, Poplar Solids & Veneers

Standard Finish: Pearl **Country:** CHINA

Features two doors with two interior adjustable shelves. Cord exit holes. Finished in Pearl with metal base in Antique Brass

8098-97 — Price: \$2907**East Camden Chest**

Collection: EAST CAMDEN

Width: 42 Depth: 20 Height: 40 Weight: 144 / 144 lbs Cube: 27.13

Materials: Poplar Solids & Veneers

Standard Finish: Pearl **Country:** CHINA

Finished in Pearl with acrylic and Antique Brass hardware, five reeded-front drawers with self-closing drawer guides. Also available in any Monogram Finish as M098-97.

8098-98 — Price: \$1917**East Camden Lamp Table**

Collection: EAST CAMDEN

Width: 28 Depth: 22 Height: 24 Weight: 58 / 58 lbs Cube: 11.59

Materials: Metal, Carrara Marble, & Glass

Standard Finish: N/A **Country:** CHINA

Finished in Pearl with Antique Brass accents, Carrara marble top, and one fixed glass shelf.

CASEGOODS

8098-99 — Price: \$2577

East Camden Console Table

Collection: EAST CAMDEN

Width: 72 **Depth:** 18 **Height:** 36 **Weight:** 119 / 119 lbs **Cube:** 14.75

Materials: Metal, Carrara Marble, Poplar Solids & Veneers

Standard Finish: Pearl **Country:** CHINA

Finished in Pearl with Antique Brass metal base, curved scalloped apron, and Carrara marble top.

8099-AT — Price: \$1977

Tribeca Accent Table

Collection: TRIBECA

Width: 26 **Depth:** 26 **Height:** 24 **Weight:** 56 / 56 lbs **Cube:** 12.69

Materials: Hand Distressed Oak Solids & Veneers

Standard Finish: Hudson **Country:** CHINA

Finished in Hudson with a forged metal base. Features a flip-top with hidden a storage beneath.

8099-81 — Price: \$2637

Tribeca Writing Desk

Collection: TRIBECA

Width: 64 **Depth:** 28 **Height:** 30 **Weight:** 156 / 156 lbs **Cube:** 20.69

Materials: Hand Distressed Oak Solids & Veneers

Standard Finish: Hudson **Country:** CHINA

Finished in Hudson with a display shelf on the front side of the desk. Back side of the desk features a file drawer, center drawer and two storage drawers.

8099-88 — Price: \$747

Tribeca Drink Table

Collection: TRIBECA

Width: 16 **Depth:** 16 **Height:** 20 **Weight:** 37 / 37 lbs **Cube:** 4.15

Materials: Hand Distressed Oak Solids & Veneers

Standard Finish: Hudson **Country:** CHINA

Forged metal base with a wood top finished in Hudson.

8102-CH — Price: \$3837

Temperate Grove Chest

Collection: TEMPERATE GROVE

Width: 42 **Depth:** 20 **Height:** 34 **Weight:** 165 / 165 lbs **Cube:** 22.81

Materials: White Oak Solids & Veener. Raffia accents

Standard Finish: Sanibel **Country:** CHINA

Finished in Sanibel with Brushed Brass hardware and accents and a marble top.

8102-48 — Price: \$2847

Temperate Grove Bar Cart

Collection: TEMPERATE GROVE

Width: 34 **Depth:** 23 **Height:** 34 **Weight:** 63 / 63 lbs **Cube:** 18.5

Materials: White Oak Solids & Veener. Raffia accents

Standard Finish: Sanibel **Country:** CHINA

Finished in Sanibel with glass shelves and Brushed Brass casters, hardware, and accents.

8102-85 — Price: \$5127

Temperate Grove Etageré

Collection: TEMPERATE GROVE

Width: 32 **Depth:** 15 **Height:** 80 **Weight:** 200 / 200 lbs **Cube:** 39.11

Materials: White Oak Solids & Veener. Raffia accents

Standard Finish: Sanibel **Country:** CHINA

Finished in Sanibel with Brushed Brass hardware and accents. Features two doors, one drawer, one adjustable shelf, and three glass shelves.

8102-93 — Price: \$3057

Temperate Grove Cocktail Table

Collection: TEMPERATE GROVE

Width: 54 **Depth:** 30 **Height:** 20 **Weight:** 132 / 132 lbs **Cube:** 27.15

Materials: White Oak Solids & Veener. Raffia accents

Standard Finish: Sanibel **Country:** CHINA

Finished in Sanibel with Brushed Brass hardware and accents, glass top, and raffia shelf.

8102-94 — Price: \$1437

Temperate Grove End Table

Collection: TEMPERATE GROVE

Width: 24 **Depth:** 24 **Height:** 24 **Weight:** 40 / 40 lbs **Cube:** 11.17

Materials: White Oak Solids & Veener. Raffia accents

Standard Finish: Sanibel **Country:** CHINA

Finished in Sanibel with Brushed Brass hardware and accents, glass top, and raffia shelf.

8102-96 — Price: \$4257

Temperate Grove Console Table

Collection: TEMPERATE GROVE

Width: 70 **Depth:** 14 **Height:** 36 **Weight:** 123 / 123 lbs **Cube:** 29.44

Materials: White Oak Solids & Veener. Raffia accents

Standard Finish: Sanibel **Country:** CHINA

Finished in Sanibel with Brushed Brass hardware and accents, glass top, and raffia shelves.

8104-BT — Price: \$2007

Boone Forge Counter Height Table

Collection: BOONE FORGE

Width: 42 **Depth:** 42 **Height:** 36 **Weight:** 90 / 90 lbs **Cube:** 47.46

Materials: Cold Weather, Russian Pine Solids & Veneers

Standard Finish: Weathered Pecan **Country:** CHINA

Hand worn and distressed in Weathered Pecan finish with hand forged steel accents and two fixed shelves.

8104-CH — Price: \$3087

Boone Forge Sideboard

Collection:

Width: 0 **Depth:** 0 **Height:** 0 **Weight:** 260 / 260 lbs **Cube:** 53.3

Materials:

Standard Finish: Weathered Pecan **Country:** CHINA

CASEGOODS

8104-90 — Price: \$717

Boone Forge Lamp Table

Collection: BOONE FORGE

Width: 20 **Depth:** 14 **Height:** 27 **Weight:** 15 / 15 lbs **Cube:** 6.54

Materials: Cold Weather, Russian Pine Solids & Veneers

Standard Finish: Weathered Pecan **Country:** CHINA

Hand worn and distressed in Weathered Pecan finish with hand forged steel frame.

8105-AC — Price: \$2547

Belmont Accent Chest

Collection: BELMONT

Width: 48 **Depth:** 18 **Height:** 36 **Weight:** 115 / 115 lbs **Cube:** 23.84

Materials: Elm, Birch Solids & Veneers

Standard Finish: Sable **Country:** CHINA

Finished in Sable with three drawers and silver leaf inlay under drawer front carvings.

8105-AT — Price: \$897

Belmont Accent Table

Collection: BELMONT

Width: 26 **Depth:** 26 **Height:** 26 **Weight:** 25 / 25 lbs **Cube:** 3.4

Materials: Elm, Birch Solids & Veneers

Standard Finish: Sable **Country:** CHINA

Finished in Sable with one fixed shelf.

8105-CS — Price: \$1467

Belmont Chairside Table

Collection: BELMONT

Width: 26 **Depth:** 26 **Height:** 25 **Weight:** 50 / 50 lbs **Cube:** 12.93

Materials: Elm, Birch Solids & Veneers

Standard Finish: Sable **Country:** CHINA

Finished in Sable.

8105-ET — Price: \$987

Belmont Round End Table

Collection: BELMONT

Width: 22 **Depth:** 22 **Height:** 26 **Weight:** 15 / 15 lbs **Cube:** 9.52

Materials: Elm, Birch Solids & Veneers

Standard Finish: Sable **Country:** CHINA

Finished in Sable with one fixed shelf.

8105-15 — Price: \$2307

Belmont Round Dining Table

Collection: BELMONT

Width: 48 **Depth:** 48 **Height:** 30 **Weight:** 120 / 120 lbs **Cube:** 15.2

Materials: Elm and Birch Solids & Veneers

Standard Finish: Sable **Country:** CHINA

Finished in Sable.

8105-19 — Price: \$1137

Belmont Round End Table

Collection: BELMONT

Width: 24 **Depth:** 24 **Height:** 28 **Weight:** 25 / 25 lbs **Cube:** 12.07

Materials: Elm and Birch Solids & Veneers

Standard Finish: Sable **Country:** CHINA

Finished in Sable with two fixed shelves.

8105-47 — Price: \$1137

Belmont Oval End Table

Collection: BELMONT

Width: 26 **Depth:** 22 **Height:** 25 **Weight:** 25 / 25 lbs **Cube:** 11

Materials: Elm, Birch Solids & Veneers

Standard Finish: Sable **Country:** CHINA

Finished in Sable with one fixed shelf.

8105-86 — Price: \$1257

Belmont Entry Table

Collection: BELMONT

Width: 36 **Depth:** 36 **Height:** 30 **Weight:** 47 / 45 lbs **Cube:** 5.96

Materials: Elm, Birch Solids & Veneers

Standard Finish: Sable **Country:** CHINA

Finished in Sable with polished stainless steel accents. Consists of 8105-86-B (Base) and 8105-86-T (Top)

8105-88 — Price: \$747

Belmont Drink Table

Collection: BELMONT

Width: 14.5 **Depth:** 14.5 **Height:** 24 **Weight:** 15 / 15 lbs **Cube:** 5.2

Materials: Elm, Birch Solids & Veneers

Standard Finish: Sable **Country:** CHINA

Finished in Sable with one fixed shelf.

8105-93 — Price: \$1527

Belmont Rectangular Cocktail Table

Collection: BELMONT

Width: 48 **Depth:** 32 **Height:** 19 **Weight:** 65 / 65 lbs **Cube:** 8.11

Materials: Elm, Birch Solids & Veneers

Standard Finish: Sable **Country:** CHINA

Finished in Sable with one fixed shelf.

8105-94 — Price: \$1107

Belmont Square End Table

Collection: BELMONT

Width: 24 **Depth:** 24 **Height:** 26 **Weight:** 25 / 25 lbs **Cube:** 11.37

Materials: Elm, Birch Solids & Veneers

Standard Finish: Sable **Country:** CHINA

Finished in Sable.

8105-96 — Price: \$1107**Belmont Side Table****Collection:** BELMONT**Width:** 40 **Depth:** 18 **Height:** 29 **Weight:** 45 / 45 lbs **Cube:** 5.58**Materials:** Elm, Birch Solids & Veneers**Standard Finish:** Sable **Country:** CHINA

Finished in Sable with one drawer and one fixed shelf.

8105-99 — Price: \$1497**Belmont Sofa Table****Collection:** BELMONT**Width:** 60 **Depth:** 17 **Height:** 29 **Weight:** 55 / 55 lbs **Cube:** 6.24**Materials:** Elm, Birch Solids & Veneers**Standard Finish:** Sable **Country:** CHINA

Finished in Sable.

8106-ET — Price: \$1377**Edgewood End Table****Collection:** EDGEWOOD**Width:** 25.5 **Depth:** 23 **Height:** 26 **Weight:** 65 / 65 lbs **Cube:** 11.88**Materials:** Cold Weather, Russian Pine Solids and Veneers**Standard Finish:** Graystone **Country:** CHINA

Finished in Graystone with hand-forged, textured finish metal and two fixed shelves.

8106-19 — Price: \$1287**Edgewood Lamp Table****Collection:** EDGEWOOD**Width:** 26 **Depth:** 26 **Height:** 26 **Weight:** 40 / 40 lbs **Cube:** 13.15**Materials:** Cold Weather, Russian Pine Solids and Veneers**Standard Finish:** Graystone **Country:** CHINA

Finished in Graystone with a hand-forged, textured finish metal base.

8108-17 — Price: \$3147**Aspect Credenza****Collection:** ASPECT**Width:** 72 **Depth:** 18 **Height:** 35 **Weight:** 202 / 202 lbs **Cube:** 35.64**Materials:** Mango Solids**Standard Finish:** Dune **Country:** INDIA

Finished in Dune with a metal base and four doors, interior adjustable shelves and cord exit holes.

8108-96 — Price: \$3147**Aspect Credenza****Collection:** ASPECT**Width:** 72 **Depth:** 18 **Height:** 34 **Weight:** 172 / 199 lbs **Cube:** 35.32**Materials:** Mango Solids**Standard Finish:** Dune **Country:** INDIA

Finished in Dune with a metal base and four doors, interior adjustable shelves and cord exit holes.

8109-BC — Price: \$1137**Churchill Bunching Cocktail Table****Collection:** CHURCHILL**Width:** 24 **Depth:** 24 **Height:** 18 **Weight:** 55 / 55 lbs **Cube:** 8.96**Materials:** Cold Weather, Russian Pine Solids & Veneers**Standard Finish:** Tobacco **Country:** CHINA

Finished in Tobacco.

8109-MC — Price: \$3357**Churchill Media Console****Collection:** CHURCHILL**Width:** 63 **Depth:** 20 **Height:** 32 **Weight:** 185 / 185 lbs **Cube:** 29.85**Materials:** Cold Weather, Russian Pine Solids & Veneers**Standard Finish:** Tobacco **Country:** CHINA

Finished in Tobacco with three doors featuring a framed glass and metal overlay. One interior removable shelf behind each door.

8109-ST — Price: \$2547**Churchill Console****Collection:** CHURCHILL**Width:** 66 **Depth:** 17 **Height:** 34 **Weight:** 120 / 120 lbs **Cube:** 17.29**Materials:** Cold Weather, Russian Pine Solids & Veneers**Standard Finish:** Tobacco **Country:** CHINA

Finished in Tobacco with three drawers and a fixed bottom shelf.

8109-19 — Price: \$1227**Churchill Lamp Table****Collection:** CHURCHILL**Width:** 26 **Depth:** 26 **Height:** 26 **Weight:** 45 / 45 lbs **Cube:** 13.15**Materials:** Cold Weather, Russian Pine Solids & Veneers**Standard Finish:** Tobacco **Country:** CHINA

Tobacco finished wood top with a hand-forged, textured finish metal base.

8112-96 — Price: \$2937**Artemis Credenza****Collection:** ARTEMIS**Width:** 63 **Depth:** 16 **Height:** 35 **Weight:** 110 / 110 lbs **Cube:** 18.9**Materials:** Mango Solids**Standard Finish:** Onyx **Country:** INDIA

Finished in Onyx with sliding door fronts in hand-carved tambour and raffia. Interior features two adjustable shelves.

8113-BT — Price: \$1677**Rustique Counter Height Table****Collection:** RUSTIQUE**Width:** 36 **Depth:** 36 **Height:** 36 **Weight:** 60 / 60 lbs **Cube:** 14.42**Materials:** Quartered Elm, Ash Solids & Veneers**Standard Finish:** Rustique **Country:** CHINA

Finished in Rustique. Consists of 8113-BT-B (Base) and 8113-BT-T (Top)

8113-ET — Price: \$1587**Rustique End Table****Collection:** RUSTIQUE**Width:** 18 **Depth:** 28 **Height:** 27 **Weight:** 75 / 75 lbs **Cube:** 10.89**Materials:** Marble, Quartered Elm, Ash Solids & Veneers**Standard Finish:** Rustique **Country:** CHINA
One fixed shelf with mable inset top.**8113-FT — Price:** \$1707**Rustique Flip-Top Table****Collection:** RUSTIQUE**Width:** 60 **Depth:** 0 **Height:** 31 **Weight:** 90 / 90 lbs **Cube:** 8.02**Materials:** Quartered Elm, Ash Solids & Veneers**Standard Finish:** Rustique **Country:** CHINA**8113-HT — Price:** \$2307**Rustique Open Storage Console Table****Collection:** RUSTIQUE**Width:** 72 **Depth:** 16 **Height:** 36 **Weight:** 118 / 118 lbs **Cube:** 16.82**Materials:** Quartered Elm, Ash Solids & Veneers**Standard Finish:** Rustique **Country:** CHINA
Finished in Rustique with open storage and an X-frame metal base.**8113-LD — Price:** \$2277**Rustique Lateral File Deck****Collection:** RUSTIQUE**Width:** 44.75 **Depth:** 12.25 **Height:** 42 **Weight:** 0 / 80 lbs **Cube:** 18.95**Materials:** Quartered Elm, Ash Solids & Veneers**Standard Finish:** N/A **Country:** CHINA
Finished in Rustique with two inset glass shelves and adjustable LED lighting. Pairs with 8113-84 Rustique Lateral File, includes mending plates for attachment to the Lateral File.**8113-MF — Price:** \$1497**Rustique Mobile File****Collection:** RUSTIQUE**Width:** 15.5 **Depth:** 18 **Height:** 25.5 **Weight:** 0 / 91 lbs **Cube:** 7.69**Materials:** Quartered Elm, Ash Solids & Veneers**Standard Finish:** Rustique **Country:** CHINA
Finished in Rustique with black metal hardware and hidden casters. Includes one standard top drawer and one bottom lateral file drawer with a hidden pencil drawer. Fits under the 8113-81 Rustique Writing Desk.**8113-RC — Price:** \$2007**Rustique Cocktail Table****Collection:** RUSTIQUE**Width:** 64 **Depth:** 22 **Height:** 18 **Weight:** 150 / 150 lbs **Cube:** 19.56**Materials:** Quartered Elm, Ash Solids & Veneers**Standard Finish:** Rustique **Country:** CHINA**8113-TB — Price:** \$1587**Rustique Table Base****Collection:** RUSTIQUE**Width:** 26 **Depth:** 26 **Height:** 27.5 **Weight:** 70 / 70 lbs **Cube:** 13.07**Materials:** Quartered Elm and Ash Solids and Veneers**Standard Finish:** Rustique **Country:** CHINA
Rustic Elegance with hand wire brushing, creates deep finish characteristics For use with 813R-48 and -60 Table Tops.**8113-17 — Price:** \$2127**Rustique Console Table****Collection:** RUSTIQUE**Width:** 72 **Depth:** 18 **Height:** 36 **Weight:** 96 / 96 lbs **Cube:** 10.55**Materials:** Quartered Elm, Ash Solids & Veneers**Standard Finish:** Rustique **Country:** CHINA
Features two drawers.**8113-19 — Price:** \$1077**Rustique Round End Table****Collection:** RUSTIQUE**Width:** 26 **Depth:** 25 **Height:** 24 **Weight:** 35 / 35 lbs **Cube:** 11.81**Materials:** Gun Metal & Wooden Top**Standard Finish:** Rustique **Country:** CHINA
Rustique finish.**8113-43 — Price:** \$3477**Rustique Dining Table****Collection:** RUSTIQUE**Width:** 106 **Depth:** 42 **Height:** 30.5 **Weight:** 231 / 231 lbs **Cube:** 24.77**Materials:** Quartered Elm, Ash Solids & Veneers**Standard Finish:** Rustique **Country:** CHINA
Features two removable 12" leaves.**8113-81 — Price:** \$1947**Rustique Writing Desk****Collection:** RUSTIQUE**Width:** 60 **Depth:** 28 **Height:** 30 **Weight:** 108 / 108 lbs **Cube:** 10.17**Materials:** Quartered Elm, Ash Solids & Veneers**Standard Finish:** Rustique **Country:** CHINA
Rustique finish with one drawer.**8113-84 — Price:** \$3357**Rustique Lateral File****Collection:** RUSTIQUE**Width:** 47 **Depth:** 22 **Height:** 33 **Weight:** 0 / 191 lbs **Cube:** 27.24**Materials:** Quartered Elm, Ash Solids & Veneers**Standard Finish:** Rustique **Country:** CHINA
Two standard drawers and one lateral file drawer. Open storage area with a USB & Standard Outlet. Cord exit holes for equipment management.

CASEGOODS

8113-90 — Price: \$957

Rustique Lamp Table

Collection: RUSTIQUE

Width: 28 Depth: 28 Height: 28 Weight: 35 / 35 lbs Cube: 4.28

Materials: Quartered Elm, Ash Solids & Veneers

Standard Finish: Rustique Country: CHINA

Features beautiful, turned wood pedestal base with three feet finished in Rustique.

8113-96 — Price: \$1407

Rustique Console Table

Collection: RUSTIQUE

Width: 60 Depth: 12 Height: 35 Weight: 90 / 90 lbs Cube: 6.53

Materials: Quartered Elm, Ash Solids & Veneers

Standard Finish: Rustique Country: CHINA

Two drawers and one fixed shelf

8113-98 — Price: \$2247

Rustique Drum Table

Collection: RUSTIQUE

Width: 28 Depth: 28 Height: 24 Weight: 130 / 130 lbs Cube: 14.29

Materials: Marble, Quartered Elm, Ash Solids & Veneers

Standard Finish: Rustique Country: CHINA

Finished in Rustique with a Carrara marble top, one door, and on interior shelf.

8113-99 — Price: \$2247

Rustique Counter Height Sofa Table

Collection: RUSTIQUE

Width: 68 Depth: 18 Height: 36 Weight: 135 / 135 lbs Cube: 9.58

Materials: Marble, Quartered Elm, Ash Solids & Veneers

Standard Finish: Rustique Country: CHINA

Finished in Rustique with a Carrara marble top. Designed with dual functionality, this sofa table is counter height with an open end to accommodate two counter stools.

8114-AT — Price: \$897

Tranquility Shores Accent Table

Collection: TRANQUILITY SHORES

Width: 26 Depth: 26 Height: 26 Weight: 25 / 25 lbs Cube: 3.4

Materials: Birch Solids & Veneers

Standard Finish: Tranquility Country: CHINA

Features three European carved posts and one fixed shelf in Tranquility finish.

8115-15 — Price: \$1977

Grandview Dining Table

Collection: GRANDVIEW

Width: 48 Depth: 48 Height: 30 Weight: 92 / 100 lbs Cube: 13.26

Materials: Cherry solids & Veneers

Standard Finish: Candlelight Country: CHINA

Split matched veneer insets and solid edge perimeters. Consists of 8115-15-T (Top) and 8115-15-B (Base).

8115-47 — Price: \$987

Grandview Oval End Table

Collection: GRANDVIEW

Width: 30 Depth: 22 Height: 26.5 Weight: 45 / 45 lbs Cube: 5.48

Materials: Cherry solids & Veneers

Standard Finish: Candlelight Country: CHINA

Finished in Candlelight with split matched veneer insets and solid edge perimeters. One drawer and one fixed shelf.

8115-90 — Price: \$987

Grandview Chairside Table

Collection: GRANDVIEW

Width: 28 Depth: 28 Height: 27.5 Weight: 40 / 40 lbs Cube: 4.74

Materials: Cherry solids & Veneers

Standard Finish: Candlelight Country: CHINA

Finished in Candlelight with split matched veneer insets and solid edge perimeters. Two fixed shelves.

8115-94 — Price: \$987

Grandview Square End Table

Collection: GRANDVIEW

Width: 21 Depth: 21 Height: 23.5 Weight: 30 / 30 lbs Cube: 4.24

Materials: Cherry solids & Veneers

Standard Finish: Candlelight Country: CHINA

Finished in Candlelight with split matched veneer insets and solid edge perimeters.

8115-99 — Price: \$1437

Grandview Sofa Table

Collection: GRANDVIEW

Width: 56 Depth: 18 Height: 31.25 Weight: 61 / 60 lbs Cube: 9.78

Materials: Cherry solids & Veneers

Standard Finish: Candlelight Country: CHINA

Split matched veneer insets and solid edge perimeters. Consists of 8115-99-T (Top) and 8115-99-B (Base).

8116-CH — Price: \$2367

Park West Chest

Collection: PARK WEST

Width: 40 Depth: 18 Height: 36 Weight: 90 / 90 lbs Cube: 20.61

Materials: Birch Solids with Book Matched Asian Cherry Veneers

Standard Finish: Venezia Country: CHINA

Inspired by parquet woodworking, the drawer fronts and top feature a diamond pattern design finished in Venezia. Three drawers with antique brass hardware.

8116-CS — Price: \$1887

Park West Chairside Table

Collection: PARK WEST

Width: 22 Depth: 22 Height: 26 Weight: 40 / 40 lbs Cube: 10.07

Materials: Birch Solids with Book Matched Asian Cherry Veneers

Standard Finish: Venezia Country: CHINA

Antique brass base and wood top with decorative pattern finished in Venezia.

8116-95 — Price: \$1347**Park West End Table****Collection:** PARK WEST**Width:** 22 **Depth:** 26 **Height:** 28 **Weight:** 55 / 55 lbs **Cube:** 12.88**Materials:** Birch Solids with Book Matched Asian Cherry Veneers**Standard Finish:** Venezia **Country:** CHINA

Finished in Venezia with antique brass accents and hardware. One drawer and one fixed shelf.

8117-99 — Price: \$2727**Silverstone Sofa Table****Collection:** SILVERSTONE**Width:** 56 **Depth:** 14 **Height:** 36 **Weight:** 125 / 125 lbs **Cube:** 22.58**Materials:** White Oak, Elm Solids & Veneers**Standard Finish:** Graystone **Country:** CHINA

Finished in Graystone with two, quarter-cut white oak doors with a silver leaf inlay under a wood carved overlay. Two doors with a fixed, interior shelf behind each door.

8119-17 — Price: \$3267**Provence Sideboard****Collection:** PROVENCE**Width:** 60 **Depth:** 15 **Height:** 41 **Weight:** 210 / 210 lbs **Cube:** 24.41**Materials:** Marble, Select Oak Veneers & Solids**Standard Finish:** Sandstone **Country:** CHINA

Finished in Sandstone with an inset marble top and brass accents. Three top drawers, three base level doors, and one adjustable shelf behind each door.

8119-19 — Price: \$1257**Provence Round End Table****Collection:** PROVENCE**Width:** 24 **Depth:** 24 **Height:** 26 **Weight:** 45 / 45 lbs **Cube:** 3.05**Materials:** Marble, Select Oak Veneers & Solids**Standard Finish:** Sandstone **Country:** CHINA

Finished in Sandstone with an inset marble top and brass accents.

8119-88 — Price: \$987**Provence Drink Table****Collection:** PROVENCE**Width:** 16 **Depth:** 16 **Height:** 26 **Weight:** 25 / 25 lbs **Cube:** 1.89**Materials:** Marble, Select Oak Veneers & Solids**Standard Finish:** Sandstone **Country:** CHINA

Finished in Sandstone with a marble top and brass accents.

8120-15 — Price: \$2307**Manhattan Dining Table****Collection:** MANHATTAN**Width:** 48 **Depth:** 48 **Height:** 30 **Weight:** 95 / 95 lbs **Cube:** 26.48**Materials:** Adler solids & Cherry veneers**Standard Finish:** Manhattan **Country:** CHINA

Brushed nickel accents. Consists of 8120-15-T (Top) and 8120-15-B (Base).

8120-19 — Price: \$1077**Manhattan Round End Table****Collection:** MANHATTAN**Width:** 30 **Depth:** 30 **Height:** 29 **Weight:** 45 / 45 lbs **Cube:** 3.98**Materials:** Alder Solids & Cherry Veneers**Standard Finish:** Manhattan **Country:** CHINA

Finished in Manhattan with two fixed shelves.

8120-47 — Price: \$1077**Manhattan Oval End Table****Collection:** MANHATTAN**Width:** 26.5 **Depth:** 22 **Height:** 25 **Weight:** 45 / 45 lbs **Cube:** 11.31**Materials:** Alder Solids & Cherry Veneers**Standard Finish:** Manhattan **Country:** CHINA

Features one fixed shelf with a drawer and brushed nickel hardware.

8120-88 — Price: \$747**Manhattan Drink Table****Collection:** MANHATTAN**Width:** 18 **Depth:** 18 **Height:** 24 **Weight:** 10 / 10 lbs **Cube:** 6.46**Materials:** Alder Solids & Cherry Veneers**Standard Finish:** Manhattan **Country:** CHINA**8120-91 — Price:** \$1977**Manhattan Chest Cocktail****Collection:** MANHATTAN**Width:** 48.5 **Depth:** 28.5 **Height:** 19 **Weight:** 113 / 113 lbs **Cube:** 22.45**Materials:** Alder Solids & Cherry Veneers**Standard Finish:** Manhattan **Country:** CHINA

Finished in Manhattan with Brushed Nickel hardware, two pull outs on each end, and three pass through drawers.

8120-94 — Price: \$1407**Manhattan Square End Table****Collection:** MANHATTAN**Width:** 26 **Depth:** 26 **Height:** 26 **Weight:** 55 / 55 lbs **Cube:** 13.16**Materials:** Alder Solids & Cherry Veneers**Standard Finish:** Manhattan **Country:** CHINA

Finished in Manhattan with Brushed Nickel hardware and two drawers.

8120-97 — Price: \$1647**Manhattan Console****Collection:** MANHATTAN**Width:** 38 **Depth:** 22 **Height:** 29 **Weight:** 95 / 95 lbs **Cube:** 18.56**Materials:** Alder Solids & Cherry Veneers**Standard Finish:** Manhattan **Country:** CHINA

CASEGOODS

8120-98 — Price: \$1137

Manhattan Storage Lamp Table

Collection: MANHATTAN

Width: 24 **Depth:** 24 **Height:** 26 **Weight:** 60 / 60 lbs **Cube:** 11.78

Materials: Alder Solids & Cherry Veneers

Standard Finish: Manhattan **Country:** CHINA

Finished in Manhattan with Brushed Nickel hardware and two doors that open to a center storage area.

8123-CS — Price: \$1047

Harborside Chairside Table

Collection: HARBORSIDE

Width: 14.5 **Depth:** 22 **Height:** 26.5 **Weight:** 35 / 35 lbs **Cube:** 7.21

Materials: Birch Solids & Veneers

Standard Finish: Tarnished Creme **Country:** CHINA

Finished in Tarnished Creme with gallery moldings on the top and fixed shelf. One drawer.

8123-17 — Price: \$2907

Harborside Sideboard

Collection: HARBORSIDE

Width: 40 **Depth:** 17 **Height:** 40 **Weight:** 123 / 123 lbs **Cube:** 19.42

Materials: Birch Solids & Veneers

Standard Finish: Tarnished Creme **Country:** CHINA

Finished in Tarnished Creme with two doors and four adjustable interior shelves. Glass door panels feature an aged pewter metal grill.

8127-TB — Price: \$1557

Nottingham Cottage Table Base

Collection: NOTTINGTON COTTAGE

Width: 26 **Depth:** 26 **Height:** 27.5 **Weight:** 65 / 65 lbs **Cube:** 13.53

Materials: Birch Solids & Veneers

Standard Finish: Antique Parchment **Country:** CHINA

Features a Neoclassical design influence with structured elements, softened with a distressed, Antique Parchment finish.

813R-48 — Price: \$1017

Rustique 48" Table Top

Collection: RUSTIQUE

Width: 48 **Depth:** 48 **Height:** 2.5 **Weight:** 73 / 73 lbs **Cube:** 6.57

Materials: Quartered Elm & Solids, Ash Solids & Veneers

Standard Finish: Rustique **Country:** CHINA

Rustic Elegance with hand wire brushing, creates deep finish characteristics

813R-60 — Price: \$1497

Rustique 60" Table Top

Collection: RUSTIQUE

Width: 60 **Depth:** 60 **Height:** 2.5 **Weight:** 135 / 135 lbs **Cube:** 10.01

Materials: Quartered Elm & Solids, Ash Solids & Veneers

Standard Finish: Rustique **Country:** CHINA

Rustic Elegance with hand wire brushing, creates deep finish characteristics

8133-88 — Price: \$747

St. Jerome Drink Table

Collection: ST. JEROME

Width: 14.5 **Depth:** 14.5 **Height:** 24 **Weight:** 20 / 20 lbs **Cube:** 5.25

Materials: Alder Solids & Cherry Veneers

Standard Finish: Aged Brass **Country:** CHINA

Finished in a metallic, Aged Brass with one fixed shelf.

8134-ET — Price: \$1167

Origins End Table

Collection: ORIGINS

Width: 24 **Depth:** 24 **Height:** 24 **Weight:** 81 / 81 lbs **Cube:** 12.63

Materials: Mango Solids

Standard Finish: Gold Leaf **Country:** INDIA

Chiseled edge Carrara marble top. Consists of 8134-ET-B (Base) and 8134-ET-T (Top)

8134-13 — Price: \$1917

Origins Round Cocktail Table

Collection: ORIGINS

Width: 44 **Depth:** 44 **Height:** 19 **Weight:** 126 / 169 lbs **Cube:** 23.64

Materials: Metal & Carrara Marble

Standard Finish: Gold Leaf **Country:** INDIA

Chiseled edge Carrara marble top with a Gold Leaf metal base.

8134-17 — Price: \$2397

Origins Credenza

Collection: ORIGINS

Width: 47 **Depth:** 18 **Height:** 30 **Weight:** 90 / 90 lbs **Cube:** 27.82

Materials: Mango Solids

Standard Finish: Gold Leaf **Country:** INDIA

Mango Solid wood with dimensional doors covered in gold foil and a black metal base. One adjustable interior shelf behind each door.

8134-19 — Price: \$837

Origins Lamp Table

Collection: ORIGINS

Width: 18 **Depth:** 18 **Height:** 26 **Weight:** 45 / 45 lbs **Cube:** 6.78

Materials: Mango Solids

Standard Finish: Gold Leaf **Country:** INDIA

Features Carrera marble with a chiseled edge.

8134-48 — Price: \$1737

Origins Bar Cart

Collection: ORIGINS

Width: 36 **Depth:** 20 **Height:** 32 **Weight:** 171 / 171 lbs **Cube:** 21.94

Materials: Mango Solids

Standard Finish: Gold Leaf **Country:** INDIA

Onyx marble. Consists of 8134-48-B (Base) and 8134-48-T (Top)

CASEGOODS

8135-12 — Price: \$1437

Sundries Antique Copper Nesting Cocktail

Collection: SUNDRIES

Width: 28 Depth: 28 Height: 21 Weight: 56 / 56 lbs Cube: 4.19

Materials: Metal, Smoked Glass

Standard Finish: N/A **Country:** INDIA

Set of three nesting Cocktail Tables. Smoked glass tops with an Antique Copper frame and black metal bases. Consists of 8135-12-T and 8135-12-B, Sundries Antique Copper Nesting Cocktail Table Bases and Tops. Large Table: 28w X 28d X 21h, w Medium Table: 22w X 22d x 16.75h, Small Table: 19.25w X 19.25d X 14.25h

8136-12 — Price: \$2067

Sundries Bunching Cocktail Tables

Collection: SUNDRIES

Width: 24 Depth: 24 Height: 18 Weight: 220 / 0 lbs Cube: 5.99

Materials: Metal & Carrara Marble

Standard Finish: N/A **Country:** INDIA

Set of four bunching cocktail tables with Carrara marble tops and gold metal bases. Can be arranged together or used separately.

8137-81 — Price: \$2076

Caspian Writing Desk

Collection: CASPIAN

Width: 52 Depth: 27 Height: 31 Weight: 80 / 80 lbs Cube: 11.96

Materials: Mango Solids

Standard Finish: Mar De Sala **Country:** INDIA

Mar De Sala finish with two drawers and Antique Bronze hardware.

8137-99 — Price: \$3177

Caspian Console Table

Collection: CASPIAN

Width: 74 Depth: 18 Height: 35 Weight: 110 / 110 lbs Cube: 10.96

Materials: Mango Solids

Standard Finish: Mar De Sala **Country:** INDIA

Mar De Sala finish with bottom shelf.

8139-CT — Price: \$1107

Sundries French Café Table

Collection: SUNDRIES

Width: 23 Depth: 23 Height: 30 Weight: 86 / 86 lbs Cube: 13.46

Materials: Iron & Carrera Marble

Standard Finish: N/A **Country:** INDIA

Chiseled edge, Carrara marble top. Consists of 8139-CT-B (Base) and 8139-CT-T (Top)

8142-TB — Price: \$597

Table Base

Collection:

Width: 30 Depth: 30 Height: 29 Weight: 30 / 30 lbs Cube: 1.75

Materials: Rubberwood Solids

Standard Finish: Cherry **Country:** CHINA

Finished in Cherry. Pairs with 472R-42 42in Round Table Top or 472S-42 42in Square Table Top

8143-12 — Price: \$1137

Sundries Axis Nesting Cocktail Table

Collection: SUNDRIES

Width: 24 Depth: 24 Height: 18 Weight: 96 / 69 lbs Cube: 3.67

Materials: Mango Solids

Standard Finish: Umber **Country:** INDIA

Individual table: 24w X 24d X 18h, Overall of Tables: 47.75w X 46.25d X 18h

8144-DT — Price: \$5097

St. Florian Double Pedestal Dining Table

Collection: ST. FLORIAN

Width: 84 Depth: 42 Height: 30 Weight: 312 / 221 lbs Cube: 19.07

Materials: Mango Solids

Standard Finish: Charred Ecu **Country:** INDIA

Marquetry patterned top finished in Charred Ecu. Consists of 8144-DT-B (Base) and 8144-DT-T (Top)

8144-TB — Price: \$2187

St. Florian Dining Table Base

Collection: ST. FLORIAN

Width: 36 Depth: 36 Height: 28.5 Weight: 77 / 77 lbs Cube: 23.12

Materials: Mango Solids

Standard Finish: Charred Ecu **Country:** INDIA

Finished in Charred Ecu. Pairs with 8144-60, St. Florian Dining Table 60" Round Top.

8144-17 — Price: \$3297

St. Florian Credenza

Collection: ST. FLORIAN

Width: 79 Depth: 19 Height: 35 Weight: 190 / 223 lbs Cube: 40.77

Materials: Mango Solids

Standard Finish: Charred Ecu **Country:** INDIA

Finished in Charred Ecu with brass hardware and metal base. Four doors with adjustable interior shelves.

8144-43-C — Price: \$297

Double Pedestal Dining Table Center

Collection: ST. FLORIAN

Width: 0 Depth: 0 Height: 0 Weight: 20 / 20 lbs Cube: 1.77

Materials: Mango Solids

Standard Finish: Charred Ecu **Country:** INDIA

Features a metal base.

8144-43 — Price: \$3780

St. Florian Double Pedestal Dining Table

Collection: ST. FLORIAN

Width: 84 Depth: 42 Height: 30 Weight: 227 / 227 lbs Cube: 20.55

Materials: Mango Solids

Standard Finish: Charred Ecu **Country:** INDIA

Marquetry patterned top finished in Charred Ecu. Consists of 8144-43-B (Base) and 8144-43-T (Top)

8144-60 — Price: \$1887**St. Florian Dining Table 60" Round Top****Collection:** ST. FLORIAN**Width:** 60 **Depth:** 60 **Height:** 1.5 **Weight:** 134 / 134 lbs **Cube:** 12.99**Materials:** Mango Solids**Standard Finish:** Charred Ecu **Country:** INDIA

Marquetry patterned top finished in Charred Ecu. Pairs with 8144-TB, St. Florian Pedestal Dining Table.

8144-96 — Price: \$2997**St. Florian Credenza****Collection:** ST. FLORIAN**Width:** 76 **Depth:** 18 **Height:** 34 **Weight:** 179 / 305 lbs **Cube:** 36.71**Materials:** Mango Solids**Standard Finish:** Charred Ecu **Country:** INDIA

Marquetry patterned door fronts finished in Charred Ecu with brass hardware and a metal base. Four doors and adjustable interior shelves.

8146-12 — Price: \$1497**Sundries Stone Inlay Nesting Cocktail****Collection:** SUNDRIES**Width:** 29.5 **Depth:** 29.5 **Height:** 19 **Weight:** 124 / 124 lbs **Cube:** 17.27**Materials:** Brass Plated Metal, White Carrara Marble**Standard Finish:** N/A **Country:** INDIA

Set of two nesting cocktail tables with an inset marble top and metal base plated in Antique Brass. Large Table: 29.5w X 29.5d X 19h, Small Table: 23.75w X 23.75d X 15h

8147-NS — Price: \$987**Soulful Textures Marble Inlay Nesting End Table****Collection:** SOULFUL TEXTURES**Width:** 18.5 **Depth:** 33.5 **Height:** 26 **Weight:** 50 / 50 lbs **Cube:** 5.81**Materials:** Stone with Antique Brass Inlay, Metal**Standard Finish:** N/A **Country:** INDIA

Set of two egg-shaped white stone tops. One features brass inlay pattern. Large table - 27 5/8 x 22 x 21 Small table - 20 x 15 3/4 x 17 1/2

8147-12 — Price: \$1497**Soulful Textures Skipping Stone Nesting Cocktail Table****Collection:** SOULFUL TEXTURES**Width:** 33 **Depth:** 25 **Height:** 18 **Weight:** 42 / 42 lbs **Cube:** 4.25**Materials:** Metal**Standard Finish:** Aged Bronze **Country:** INDIA

Four-piece layered cocktail tables smooth and textured metal tops finished in Aged Brass and black metal legs. Large w33 d25 h18. Medium w27.5 d21.5 h16. Small w19.75 d15.25 h15.25. Extra Small w13.75 d12.5 h14

8147-19 — Price: \$447**Soulful Textures End Table****Collection:** SOULFUL TEXTURES**Width:** 19 **Depth:** 19 **Height:** 21 **Weight:** 18 / 18 lbs **Cube:** 2.25**Materials:** Metal**Standard Finish:** Aged Bronze **Country:** INDIA

Metal top finished in Aged Brass with a crosshatch texture and a metal tulip base in black. Large: w20 d20 h22.25 Small: w14.25 d14.25 h19

8147-49 — Price: \$747**Soulful Textures Nesting End Table****Collection:** SOULFUL TEXTURES**Width:** 20 **Depth:** 20 **Height:** 22 **Weight:** 56 / 56 lbs **Cube:** 14.57**Materials:** Metal & Carrara Marble**Standard Finish:** Aged Bronze **Country:** INDIA

Set of two nesting tables with Carrara marble tops on Aged Brass metal bases. One table top features an inlaid Aged Brass pattern. Large - 20 x 20 x 21 3/4. Small - 13 3/4 x 13 3/4 x 19 1/4

8147-96 — Price: \$1197**Soulful Textures Argyle Inlay Stone Console Table****Collection:** SOULFUL TEXTURES**Width:** 47.25 **Depth:** 11.5 **Height:** 30 **Weight:** 67 / 67 lbs **Cube:** 14.32**Materials:** Stone with Antique Brass Inlay, Metal**Standard Finish:** N/A **Country:** INDIA

Features an Antique Brass inlay in an argyle pattern on a white stone top. Consists of 8147-96-B (Base) and 8147-96-T (Top)

8148-93 — Price: \$2727**Ivory Coast Cocktail Table****Collection:** IVORY COAST**Width:** 54 **Depth:** 30 **Height:** 18 **Weight:** 103 / 103 lbs **Cube:** 12.62**Materials:** Mango Solids**Standard Finish:** Bleached Bone **Country:** INDIA

Bleached Bone inlaid top with a wooden base finished in Native.

8148-95 — Price: \$1017**Ivory Coast Box End Table****Collection:** IVORY COAST**Width:** 18 **Depth:** 14 **Height:** 27 **Weight:** 55 / 55 lbs **Cube:** 7.65**Materials:** Mango Solids**Standard Finish:** Bleached Bone **Country:** INDIA

Bleached Bone inlaid top with a gold metal base.

8150-86 — Price: \$1257**Genesis Entry Table****Collection:****Width:** 36 **Depth:** 36 **Height:** 30 **Weight:** 47 / 45 lbs **Cube:** 5.75**Materials:** Casual Solids & Veneers**Standard Finish:** Dusty Khaki **Country:** CHINA**8151-13 — Price:** \$3147**Avington Cocktail Table****Collection:****Width:** 40 **Depth:** 40 **Height:** 18.5 **Weight:** 236 / 236 lbs **Cube:** 31.2**Materials:** Mango Solids**Standard Finish:** N/A **Country:** INDIA

Wooden chip layered base from Mango Solids. Consists of 8151-13-B (Base) and 8151-13-T (Top)

CASEGOODS

8153-DT — Price: \$2997

Acquisition Dining Table

Collection: ACQUISITION

Width: 84 **Depth:** 40 **Height:** 30 **Weight:** 161 / 161 lbs **Cube:** 17.74

Materials: Mango Solids

Standard Finish: N/A **Country:** INDIA

Dining Table Top finished in Natural Clear. Consists of 8153-DT-B (Base) and 8153-DT-T (Top)

8154-17 — Price: \$2937

Acquisition Credenza

Collection: ACQUISITION

Width: 59 **Depth:** 15.75 **Height:** 33.5 **Weight:** 131 / 131 lbs **Cube:** 24.55

Materials: Mango Solids

Standard Finish: Natural **Country:** INDIA

Features two doors, two adjustable interior shelves, and three drawers. Finished in Natural with gold metal hairpin legs and gold hardware.

8157-CT — Price: \$1197

Sundries Clover Leaf Cocktail Table

Collection: SUNDRIES

Width: 29.5 **Depth:** 29.5 **Height:** 14 **Weight:** 56 / 56 lbs **Cube:** 8.83

Materials: Metal & Marble

Standard Finish: Black **Country:** INDIA

White marble top inset in gold metal frame. Consists of 8157-CT-B (Base) 8157-CT-T (Top)

8158-CS — Price: \$987

La Bella Chairside Table

Collection: LA BELLA

Width: 18 **Depth:** 18 **Height:** 24 **Weight:** 0 / 0 lbs **Cube:** 4.5

Materials: Metal

Standard Finish: N/A **Country:** INDIA

Features a marble top with a gold leaf metal base. Consists of 8158-CS-T and 8158-CS-B, La Bella Chairside Table Top and Base.

8158-CT — Price: \$1317

La Bella Cocktail Table

Collection: LA BELLA

Width: 30 **Depth:** 30 **Height:** 18.75 **Weight:** 35 / 35 lbs **Cube:** 13.03

Materials: Metal

Standard Finish: N/A **Country:** INDIA

Wooden top in a Natural finish with a black metal base.

8158-ET — Price: \$1017

La Bella End Table

Collection: LA BELLA

Width: 22.5 **Depth:** 17.5 **Height:** 22.5 **Weight:** 0 / 0 lbs **Cube:** 5.12

Materials: Metal Base / White Marble Top

Standard Finish: N/A **Country:** INDIA

Carrara marble top with an antique brass metal base. Consists of 8158-ET-T and 8158-ET-B, La Bella End Table Top and Base.

8158-13 — Price: \$1407

La Bella Cocktail Table

Collection: LA BELLA

Width: 36 **Depth:** 36 **Height:** 16.5 **Weight:** 68 / 68 lbs **Cube:** 19.51

Materials: Metal

Standard Finish: N/A **Country:** INDIA

Glass top. Consists of 8158-13-B (Base) and 8158-13-T (Top)

8158-28 — Price: \$567

La Bella Accent Table

Collection: LA BELLA

Width: 15.5 **Depth:** 15.5 **Height:** 20.5 **Weight:** 21 / 21 lbs **Cube:** 4.3

Materials: Metal Base / White Marble Top

Standard Finish: N/A **Country:** INDIA

Hexagon shaped white marble top. Consists of 8158-28-B (Base) and 8158-28-T (Top)

8158-90 — Price: \$1017

La Bella Chairside Table

Collection: LA BELLA

Width: 20 **Depth:** 20 **Height:** 20 **Weight:** 0 / 0 lbs **Cube:** 4.62

Materials: Metal Base / White Marble Top

Standard Finish: N/A **Country:** INDIA

Round white marble top with a metal base finished in Antique Brass. Consists of 8158-90-T and 8158-90-B, La Bella Chairside Table Top and Base.

8158-99 — Price: \$2037

La Bella Sofa Table

Collection: LA BELLA

Width: 60.25 **Depth:** 16.75 **Height:** 34 **Weight:** 119 / 119 lbs **Cube:** 31.17

Materials: Metal Base / White Marble Top

Standard Finish: N/A **Country:** INDIA

White marble top. Consists of 8158-99-B (Base) and 8158-99-T (Top)

8159-12 — Price: \$987

Sundries Starburst Rectangular Nesting Cocktail

Collection: SUNDRIES

Width: 24.5 **Depth:** 24 **Height:** 17.75 **Weight:** 42 / 42 lbs **Cube:** 8.43

Materials: Metal

Standard Finish: N/A **Country:** INDIA

Set of two rectangular end tables with bronze, textured metal tops in a Starburst design and black metal bases. Large Table: 24.5w X 24d X 17h, Small Table: 18.25w X 18.25d X 17.75h

8160-46 — Price: \$1077

Revelation Oval Cocktail Table

Collection: REVELATION

Width: 44 **Depth:** 26 **Height:** 19.5 **Weight:** 45 / 45 lbs **Cube:** 6.04

Materials: Elm Solids & Veneers

Standard Finish: Graphite **Country:** CHINA

Finished in a deep Granite and hand wiped to reveal rich, brown undertones.

CASEGOODS

8160-47 — Price: \$1047

Revelation Oval End Table

Collection: REVELATION

Width: 26 Depth: 18 Height: 24.5 Weight: 14 / 30 lbs Cube: 10.9

Materials: Elm Solids & Veneers

Standard Finish: Graphite **Country:** CHINA

Finished in a deep Granite and hand wiped to reveal rich, brown undertones. One fixed shelf.

8160-90 — Price: \$1347

Revelation Lamp Table

Collection: REVELATION

Width: 28 Depth: 28 Height: 29 Weight: 40 / 40 lbs Cube: 16.66

Materials: Elm Solids & Veneers

Standard Finish: Graphite **Country:** CHINA

Finished in a deep Granite and hand wiped to reveal rich, brown undertones. One fixed shelf.

8160-95 — Price: \$1167

Revelation Rectangular End Table

Collection: REVELATION

Width: 28 Depth: 19 Height: 28 Weight: 45 / 45 lbs Cube: 11.76

Materials: Elm Solids & Veneers

Standard Finish: Graphite **Country:** CHINA

Finished in a deep Granite and hand wiped to reveal rich, brown undertones. One drawer and one fixed shelf.

8160-96 — Price: \$2337

Revelation Chest

Collection: REVELATION

Width: 49 Depth: 20.5 Height: 35 Weight: 125 / 125 lbs Cube: 26.33

Materials: Elm Solids & Veneers

Standard Finish: Graphite **Country:** CHINA

Four drawer curved chest finished in a deep Granite and hand wiped to reveal rich, brown undertones.

8163-CS — Price: \$597

Sundries Round Trumpet Based Chairside Table

Collection: SUNDRIES

Width: 24 Depth: 24 Height: 15 Weight: 16 / 16 lbs Cube: 4.66

Materials: Metal

Standard Finish: N/A **Country:** INDIA

Antique Copper table top with black, powder coated trumpet base. Can be used alone or nests with 8163-13, Sundries Round Trumpet Based Cocktail Table.

8163-90 — Price: \$597

Goldie Drink Table

Collection: SUNDRIES

Width: 15 Depth: 15 Height: 22 Weight: 25 / 25 lbs Cube: 2.86

Materials: Metal

Standard Finish: N/A **Country:** INDIA

Black finish exterior with gold leaf interior.

8164-AC — Price: \$2847

Westwood Accent Chest

Collection: WESTWOOD

Width: 48 Depth: 18 Height: 36 Weight: 135 / 135 lbs Cube: 23.78

Materials: Select Oak Solids & Veneers

Standard Finish: Graphite **Country:** CHINA

Finished in Graphite with brass accents, a marble inset top, two doors, and an adjustable interior shelf behind each door.

8164-BT — Price: \$1707

Westwood Counter Height Table

Collection: WESTWOOD

Width: 36 Depth: 36 Height: 36 Weight: 85 / 85 lbs Cube: 7.82

Materials: Select Oak Solids & Veneers

Standard Finish: Graphite **Country:** CHINA

Finished in Graphite with brass accents.

8164-17 — Price: \$3207

Westwood Sideboard

Collection: WESTWOOD

Width: 60 Depth: 15 Height: 41 Weight: 210 / 210 lbs Cube: 24.41

Materials: Select Oak Solids & Veneers

Standard Finish: Graphite **Country:** CHINA

Finished in Graphite with brass accents, a marble inset top, three top drawers, three base level doors, and one adjustable shelf behind each door.

8164-19 — Price: \$1257

Westwood Round End Table

Collection: WESTWOOD

Width: 24 Depth: 24 Height: 26 Weight: 45 / 45 lbs Cube: 3.05

Materials: Select Oak Solids & Veneers

Standard Finish: Graphite **Country:** CHINA

Finished in Graphite with brass accents and a marble inset top.

8164-88 — Price: \$807

Westwood Drink Table

Collection: WESTWOOD

Width: 16 Depth: 16 Height: 26 Weight: 25 / 25 lbs Cube: 1.4

Materials: Select Oak Solids & Veneers

Standard Finish: Graphite **Country:** CHINA

Finished in Graphite with brass accents and a marble top.

8168-93 — Price: \$4617

Beatbox Cocktail Table

Collection: BEATBOX

Width: 54 Depth: 30 Height: 16 Weight: 194 / 194 lbs Cube: 25.03

Materials: Metal

Standard Finish: METALIC ONYX **Country:** VIETNAM

Forged steel finished in Metallic Onyx with Brass hardware and 3/16" tempered glass top. Two Drawers.

CASEGOODS

8168-94 — Price: \$1647

Beatbox End Table

Collection: BEATBOX

Width: 24 Depth: 24 Height: 24 Weight: 125 / 125 lbs Cube: 13.78

Materials: Metal

Standard Finish: METALIC ONYX **Country:** VIETNAM

Forged steel finished in Metallic Onyx with Brass hardware and 3/16" tempered glass top. One Drawer.

8168-96 — Price: \$3897

Beatbox Small Console

Collection: BEATBOX

Width: 38 Depth: 18 Height: 28 Weight: 122 / 122 lbs Cube: 14.87

Materials: Metal

Standard Finish: METALIC ONYX **Country:** VIETNAM

Forged steel finished in Metallic Onyx with Brass hardware and 3/16" tempered glass doors. One interior shelf.

8171-49 — Price: \$507

Sundries Round Nesting End Table

Collection: SUNDRIES

Width: 18 Depth: 18 Height: 20 Weight: 26 / 26 lbs Cube: 0.82

Materials: Metal

Standard Finish: N/A **Country:** INDIA

Set of two, round metal spot tables finished in Antique Copper. Metal tops feature a textured, starburst design. Large Table: 18w X 18d X 20h, Small Table: 15w X 15d X 18h

8172-88 — Price: \$627

Bobo Drink Table

Collection: SUNDRIES

Width: 12 Depth: 12 Height: 22 Weight: 17 / 17 lbs Cube: 1.83

Materials: Mango Solids

Standard Finish: N/A **Country:** INDIA

8173-CH — Price: \$3147

Willow Chest

Collection: SUNDRIES

Width: 42 Depth: 19 Height: 38 Weight: 53 / 53 lbs Cube: 17.54

Materials: Mango Solids

Standard Finish: N/A **Country:** INDIA

Features two doors with magnetic door catches. Two adjustable shelves behind each door. Vented back panel.

8174-CH — Price: \$2397

Penelope Chest

Collection: SUNDRIES

Width: 42 Depth: 18 Height: 36 Weight: 150 / 150 lbs Cube: 15.75

Materials: Mango Solids

Standard Finish: N/A **Country:** INDIA

Features two doors with magnetic door catches. Two adjustable shelves behind each door. Vented back panel.

8181-CH — Price: \$2397

Bronx Chest

Collection: SUNDRIES

Width: 52 Depth: 18 Height: 38 Weight: 150 / 150 lbs Cube: 20.58

Materials: Mango Solids, Metal

Standard Finish: N/A **Country:** INDIA

8181-48 — Price: \$5787

Sundries Bar Cabinet

Collection: SUNDRIES

Width: 36 Depth: 19 Height: 70 Weight: 289 / 289 lbs Cube: 36.92

Materials: Quartered Ash Solids & Veneers, Brushed Brass Metal

Standard Finish: Sheer Dove **Country:** CHINA

Finished in Sheer Dove with a Brushed Brass metal base and two doors, two interior drawers, mirrored back panel, pull-out shelf, LED lighting, and bottle and stemware storage. Doors open to 270 degrees. Also available in any Monogram Finish as M181-48.

8184-TB — Price: \$1107

Trumpet Dining Height Base

Collection: LIVE EDGE, LAMINATE TABLE TOP AND BASE

Width: 20.5 Depth: 20.5 Height: 28 Weight: 60 / 60 lbs Cube: 11.93

Materials: Metal

Standard Finish: Blanca **Country:** CHINA

Trumpet shaped metal base in Blanca finish. This style is sold as one base. When pairing with rectangular Live Edge tops, two bases are required.

8185-TB — Price: \$1107

Trumpet Dining Height Base

Collection: LIVE EDGE, LAMINATE TABLE TOP AND BASE

Width: 20.5 Depth: 20.5 Height: 28 Weight: 59 / 59 lbs Cube: 11.73

Materials: Metal

Standard Finish: Oro **Country:** CHINA

Trumpet shaped metal base in Oro finish. This style is sold as one base. When pairing with rectangular Live Edge tops, two bases are required.

8186-CB — Price: \$687

Titan Café Height Base

Collection: LIVE EDGE, LAMINATE TABLE TOP AND BASE

Width: 24 Depth: 24 Height: 29 Weight: 40 / 40 lbs Cube: 2.25

Materials: Metal

Standard Finish: N/A **Country:** CHINA

Black metal base. This style is sold as one base. When pairing with rectangular Live Edge tops, two bases are required.

8186-TB — Price: \$687

Titan Dining Base

Collection: LIVE EDGE, LAMINATE TABLE TOP AND BASE

Width: 35 Depth: 35 Height: 29 Weight: 45 / 45 lbs Cube: 2.8

Materials: Metal

Standard Finish: N/A **Country:** CHINA

Black metal base. This style is sold as one base. When pairing with rectangular Live Edge tops, two bases are required.

8189-AC — Price: \$2967**Expedition Chest****Collection:** EXPEDITION**Width:** 41.25 **Depth:** 19.25 **Height:** 34 **Weight:** 128 / 128 lbs **Cube:** 20.86**Materials:** Figured Eucalyptus & Oak Solids,Cast Iron Base**Standard Finish:** GRECIAN CLAY **Country:** CHINA

Features a rectangular wood case finished in Grecian Clay with three drawers contrasted in Creme Brulee finish and mounted with cast brass bar pulls. The black, cast iron base features linear corner legs joined by a low X-stretcher. Also available in any Monogram Finish as M189-AC.

8189-AD — Price: \$2637**Expedition Console****Collection:** EXPEDITION**Width:** 60 **Depth:** 15.25 **Height:** 34 **Weight:** 115 / 119 lbs **Cube:** 26.4**Materials:** Figured Eucalyptus & Oak Solids**Standard Finish:** GRECIAN CLAY **Country:** CHINA

Three Drawers. Finished in Grecian Clay with contrast drawer fronts in Creme Brulee. Also available in any Monogram Finish as M189-AD

8189-CC — Price: \$1347**Expedition End Table****Collection:** EXPEDITION**Width:** 14 **Depth:** 22 **Height:** 23 **Weight:** 63 / 63 lbs **Cube:** 7.62**Materials:** Figured Eucalyptus & Oak Solids,Cast Iron Base**Standard Finish:** GRECIAN CLAY **Country:** CHINA

Two Drawers. Finished in Grecian Clay with contrast drawer fronts in Creme Brulee. Cast Iron Base. Also available in any Monogram Finish as M189-CC

8189-CH — Price: \$2967**Expedition Chest****Collection:** EXPEDITION**Width:** 49 **Depth:** 18.75 **Height:** 34 **Weight:** 130 / 130 lbs **Cube:** 23.61**Materials:** Figured Eucalyptus & Oak Solids,Cast Iron Base**Standard Finish:** GRECIAN CLAY **Country:** CHINA

Features a rectangular wood case finished in Grecian Clay with two storage drawers veneered in a herringbone pattern. Cast iron metal base with gracefully tapered corner legs. Also available in any Monogram Finish as M189-CH

8189-HT — Price: \$1587**Expedition Demilune Console****Collection:** EXPEDITION**Width:** 56 **Depth:** 16 **Height:** 32 **Weight:** 77 / 77 lbs **Cube:** 5.27**Materials:** Figured Eucalyptus & Oak Solids**Standard Finish:** GRECIAN CLAY **Country:** CHINA

Metal Accents. Lower Shelf. Finished In Grecian Clay. Also available in any Monogram Finish as M189-HT

8189-13 — Price: \$1737**Expedition Round Cocktail Table****Collection:** EXPEDITION**Width:** 42 **Depth:** 42 **Height:** 18 **Weight:** 88 / 88 lbs **Cube:** 6.84**Materials:** Figured Eucalyptus & Oak Solids,Metal Accents**Standard Finish:** GRECIAN CLAY **Country:** CHINA

Metal Accents. Lower Shelf. Finished in Grecian Clay. Also available in any Monogram Finish as M189-13

8189-19 — Price: \$1197**Expedition Round End Table****Collection:** EXPEDITION**Width:** 25 **Depth:** 25 **Height:** 25 **Weight:** 51 / 51 lbs **Cube:** 3.4**Materials:** Figured Eucalyptus & Oak Solids,Metal Accents**Standard Finish:** GRECIAN CLAY **Country:** CHINA

Metal Accents. Finished. Finished in Grecian Clay. Also available in any Monogram Finish as M189-19

8189-81 — Price: \$4377**Expedition Pedestal Desk****Collection:** EXPEDITION**Width:** 60 **Depth:** 28 **Height:** 30 **Weight:** 234 / 234 lbs **Cube:** 36.4**Materials:** Figured Eucalyptus & Oak Solids**Standard Finish:** GRECIAN CLAY **Country:** CHINA

Finished in Grecian Clay with a contrasting front panel in Creme Brulee and cast brass hardware. Includes a center keyboard drawer, two pencil drawers and two storage drawers, two lateral file drawers, and two grommets for cord management in the desktop. Also available in any Monogram Finish as M189-81

8189-88 — Price: \$927**Expedition Martini Table****Collection:** EXPEDITION**Width:** 17.75 **Depth:** 17.75 **Height:** 23 **Weight:** 29 / 29 lbs **Cube:** 2.11**Materials:** Figured Eucalyptus & Oak Solids,Metal Accents**Standard Finish:** GRECIAN CLAY **Country:** CHINA

Metal Accents. Finished. Finished in Grecian Clay. Also available in any Monogram Finish as M189-88

8189-91 — Price: \$2727**Expedition Cocktail Table****Collection:** EXPEDITION**Width:** 50 **Depth:** 30 **Height:** 19 **Weight:** 138 / 138 lbs **Cube:** 23.2**Materials:** Figured Eucalyptus & Oak Solids,Cast Iron Base**Standard Finish:** GRECIAN CLAY **Country:** CHINA

A low table designed with a rectangular wood case veneered in richly figured eucalyptus and finished in Grecian Clay. Three storage drawers on one side with cast brass hardware and a cast iron base with linear corner legs joined by a low X-stretcher. Also available in any Monogram Finish as M189-91

8189-95 — Price: \$1707**Expedition End Table****Collection:** EXPEDITION**Width:** 22 **Depth:** 28 **Height:** 26 **Weight:** 73 / 73 lbs **Cube:** 13.88**Materials:** Figured Eucalyptus & Oak Solids,Cast Iron Base**Standard Finish:** GRECIAN CLAY **Country:** CHINA

Eucalyptus veneered case finished in Grecian Clay, housing a storage drawer and mounted with cast brass hardware on a cast iron base with a low X-stretcher. Also available in any Monogram Finish as M189-95

8189-96 — Price: \$2547**Expedition Console****Collection:** EXPEDITION**Width:** 56 **Depth:** 16 **Height:** 34 **Weight:** 104 / 104 lbs **Cube:** 24.96**Materials:** Figured Eucalyptus & Oak Solids,Cast Iron Base**Standard Finish:** GRECIAN CLAY **Country:** CHINA

Eucalyptus veneered case finished in Grecian Clay, housing three storage drawers and mounted with cast brass hardware on a cast iron base with a low X-stretcher. Also available in any Monogram Finish as M189-96

8189-99 — Price: \$1497**Expedition Console****Collection:** EXPEDITION**Width:** 40 **Depth:** 11 **Height:** 32 **Weight:** 55 / 55 lbs **Cube:** 12.62**Materials:** Figured Eucalyptus & Oak Solids**Standard Finish:** GRECIAN CLAY **Country:** CHINA

Finished in Grecian Clay int contrast interior in Creme Brulee. Also available in any Monogram Finish as M189-99

8190-BT — Price: \$1827**Townsend Counter Height Table****Collection:** TOWNSEND**Width:** 36 **Depth:** 36 **Height:** 36 **Weight:** 54 / 55 lbs **Cube:** 14.21**Materials:** Elm Solids & Veneers**Standard Finish:** Cognac **Country:** CHINA

Finished in Cognac. Consists of 8190-BT-B (Base) and 8190-BT-T (Top)

8190-88 — Price: \$747**Townsend Drink Table****Collection:** TOWNSEND**Width:** 14.5 **Depth:** 14.5 **Height:** 24 **Weight:** 15 / 15 lbs **Cube:** 5.2**Materials:** Elm Solids & Veneers**Standard Finish:** Cognac **Country:** CHINA

Finished in Cognac with one fixed shelf.

8191-MF — Price: \$1497**Park Avenue Mobile File****Collection:** PARK AVENUE**Width:** 15.5 **Depth:** 18 **Height:** 24.75 **Weight:** 79 / 79 lbs **Cube:** 6.38**Materials:** Oak Solids, Figured Eucalyptus Veneer, Metal**Standard Finish:** GRECIAN CLAY **Country:** CHINA

Finished in Grecian Clay with acrylic hardware and hidden casters. Includes one standard top drawer and one bottom lateral file drawer with a hidden pencil drawer. Fits under the 8191-81 Park Avenue Desk and M191-81 Monogram Park Avenue Desk. Also available in any Monogram Finish as M191-MF.

8191-81 — Price: \$3837**Park Avenue Desk****Collection:** PARK AVENUE**Width:** 64 **Depth:** 20 **Height:** 36.5 **Weight:** 160 / 160 lbs **Cube:** 44.31**Materials:** Oak Solids, Figured Eucalyptus Veneer, Metal**Standard Finish:** GRECIAN CLAY **Country:** CHINA

Finished in Grecian Clay. Features three drawers, center drawer with pencil tray and standard outlet with USB port. Also available in any Monogram Finish as M191-81.

8191-84 — Price: \$2967**Park Avenue Lateral File****Collection:** PARK AVENUE**Width:** 36 **Depth:** 19 **Height:** 29 **Weight:** 152 / 152 lbs **Cube:** 16.4**Materials:** Oak Solids, Figured Eucalyptus Veneer, Metal**Standard Finish:** GRECIAN CLAY **Country:** CHINA

Finished in Grecian Clay. Features two drawers with lateral files, two doors with interior printer storage, and a standard outlet with a USB port. Also available in any Monogram Finish as M191-84.

8192-TB — Price: \$1797**Cracked Ice Dining Table Base****Collection:** LIVE EDGE**Width:** 29 **Depth:** 29 **Height:** 28 **Weight:** 23 / 23 lbs **Cube:** 16.96**Materials:** Metal**Standard Finish:** Gold **Country:** CHINA

Metal base in Gold finish.

8194-19 — Price: \$1197**Vero Round Lamp Table****Collection:** VERO**Width:** 26 **Depth:** 26 **Height:** 26 **Weight:** 35 / 35 lbs **Cube:** 4.58**Materials:** Rubberwood, Tulip Wood Solids & Veneers**Standard Finish:** Sable **Country:** CHINA

High pressure laminate top with solid wood edge finished in Sable.

8194-46 — Price: \$1617**Vero Oval Cocktail Table****Collection:** VERO**Width:** 48 **Depth:** 26 **Height:** 19 **Weight:** 60 / 60 lbs **Cube:** 6.54**Materials:** Rubberwood, Tulip Wood Solids & Veneers**Standard Finish:** Sable **Country:** CHINA

High pressure laminate top with solid wood edge finished in Sable.

8194-88 — Price: \$1047**Vero Drink Table****Collection:** VERO**Width:** 19 **Depth:** 19 **Height:** 25 **Weight:** 25 / 25 lbs **Cube:** 6.87**Materials:** Rubberwood, Tulip Wood Solids & Veneers**Standard Finish:** Sable **Country:** CHINA

High pressure laminate top with a solid wood edge finished in Sable. The cross leg metal base is finished in Polished Nickel.

8194-90 — Price: \$1137**Vero Lamp Table****Collection:** VERO**Width:** 20 **Depth:** 20 **Height:** 25 **Weight:** 30 / 30 lbs **Cube:** 8**Materials:** Rubberwood, Tulip Wood Solids & Veneers**Standard Finish:** Sable **Country:** CHINA

High pressure laminate top with solid wood edge finished in Sable.

8194-98 — Price: \$1587**Vero Storage Lamp Table****Collection:** VERO**Width:** 24 **Depth:** 24 **Height:** 26 **Weight:** 55 / 55 lbs **Cube:** 11.68**Materials:** Rubberwood, Tulip Wood Solids & Veneers**Standard Finish:** Sable **Country:** CHINA

High pressure laminate top with solid wood edge finished in Sable.

CASEGOODS

8195-AT — Price: \$597

Veneto Accent Table

Collection: VENETO

Width: 14 Depth: 10 Height: 22 Weight: 23 / 26 lbs Cube: 3.66

Materials: Hand Forged Metal, Calcutta Stone

Standard Finish: N/A Country: INDIA

Hand-forged, hammered metal frame finished in Antique Gold with an inset Calcutta marble top.

8195-CS — Price: \$1167

Veneto End Table

Collection: VENETO

Width: 18 Depth: 18 Height: 22 Weight: 65 / 65 lbs Cube: 7.79

Materials: Hand Forged Metal, Calcutta Stone

Standard Finish: N/A Country: INDIA

Hand-forged, hammered metal frame finished in Antique Gold with a Calcutta marble top.

8195-13 — Price: \$1947

Veneto Cocktail Table

Collection: VENETO

Width: 36 Depth: 36 Height: 18 Weight: 148 / 148 lbs Cube: 26.75

Materials: Hand Forged Metal, Calcutta Stone

Standard Finish: N/A Country: INDIA

Hand-forged, hammered metal frame finished in Antique Gold with a Calcutta marble top.

8195-19 — Price: \$747

Veneto End Table

Collection: VENETO

Width: 16 Depth: 16 Height: 23 Weight: 45 / 45 lbs Cube: 6.08

Materials: Hand Forged Metal, Calcutta Stone

Standard Finish: N/A Country: INDIA

Hand-forged, hammered metal frame finished in Antique Gold with a Calcutta marble top.

8195-28 — Price: \$1377

Veneto Accent Table

Collection: VENETO

Width: 16 Depth: 16 Height: 22 Weight: 45 / 45 lbs Cube: 4.78

Materials: Hand Forged Metal, Calcutta Stone

Standard Finish: N/A Country: INDIA

Hand-forged, hammered metal in multiple textures.

8195-49 — Price: \$1017

Veneto Nesting End Table

Collection: VENETO

Width: 28 Depth: 16 Height: 24 Weight: 83 / 83 lbs Cube: 10.3

Materials: Hand Forged Metal, Calcutta Stone

Standard Finish: N/A Country: INDIA

Set of two nesting tables in hand-forged, hammered metal frames finished in Antique Gold with a Calcutta marble tops. Large table 18 7/8 x 11 1/8 x 22 1/4 Small table 16 x 16 x 24 1/4

8195-88 — Price: \$447

Veneto Drink Table

Collection: VENETO

Width: 10 Depth: 10 Height: 22 Weight: 14 / 30 lbs Cube: 3.4

Materials: Hand Forged Metal, Calcutta Stone

Standard Finish: N/A Country: INDIA

Hand-forged, hammered metal frame finished in Antique Gold with a Calcutta marble top.

8196-90 — Price: \$1047

Artisan Chairside Table

Collection: ARTISAN

Width: 20 Depth: 20 Height: 25 Weight: 20 / 20 lbs Cube: 7.84

Materials: Birch Solids with Fashioned Cherry Veneers

Standard Finish: Mica Country: CHINA

Finished in Mica and lightly wiped to achieve a warm transparency of grain.

827R-48 — Price: \$987

Nottingham Cottage Round Table Top

Collection: NOTTINGTON COTTAGE

Width: 48 Depth: 48 Height: 2.5 Weight: 80 / 80 lbs Cube: 6.51

Materials: Birch Solids & Veneers

Standard Finish: Antique Parchment Country: CHINA

48" round top in an Antique Parchment finish. Pairs with 8127-TB, Nottingham Cottage Table Base.

T-BE54-WD — Price: \$4797

Blonde Crotch Cut Walnut 54" Waterfall Desk

Collection: LIVE EDGE

Width: 54 Depth: 0 Height: 30 Weight: 210 / 210 lbs Cube: 48.86

Materials: Crotch Walnut & Metal

Standard Finish: BLONDE WALNUT Country: USA

Natural American Walnut with a trapezoid metal base finished in Bronze.

T-CW54-WC — Price: \$4377

Crotch Cut Walnut 54" Waterfall Cocktail Table

Collection: LIVE EDGE

Width: 54 Depth: 0 Height: 18 Weight: 102 / 102 lbs Cube: 26.57

Materials: Crotch Walnut

Standard Finish: Natural Country: USA

Natural American Walnut with a trapezoid metal base finished in Bronze.

T-CW54-WD — Price: \$5037

Crotch Cut Walnut 54" Waterfall Desk

Collection: LIVE EDGE

Width: 54 Depth: 0 Height: 30 Weight: 155 / 220 lbs Cube: 48.86

Materials: Crotch Walnut

Standard Finish: Natural Country: USA

Natural American Walnut with a trapezoid metal base finished in Bronze.

T-HG54-WC — Price: \$4647

Heritage Guanacaste 54" Waterfall Cocktail Table

Collection: LIVE EDGE

Width: 54 **Depth:** 0 **Height:** 18 **Weight:** 89 / 89 lbs **Cube:** 26.57

Materials: Guanacaste

Standard Finish: Bronze **Country:** USA

Heritage stained Guanacaste with a trapezoid metal base finished in Bronze.

T-HG54-WD — Price: \$5787

Heritage Guanacaste 54" Waterfall Desk

Collection: LIVE EDGE

Width: 54 **Depth:** 0 **Height:** 30 **Weight:** 155 / 155 lbs **Cube:** 42.45

Materials: Guanacaste

Standard Finish: Bronze **Country:** USA

Heritage stained Guanacaste with a trapezoid metal base finished in Bronze.

T-LE54-WC — Price: \$4377

Natural Guanacaste 54" Waterfall Cocktail Table

Collection: LIVE EDGE

Width: 54 **Depth:** 0 **Height:** 18 **Weight:** 102 / 102 lbs **Cube:** 26.57

Materials: Guanacaste

Standard Finish: Natural **Country:** USA

Natural Guanacaste with a trapezoid metal base finished in Bronze.

T-LE54-WD — Price: \$5247

Natural Guanacaste 54" Waterfall Desk

Collection: LIVE EDGE

Width: 54 **Depth:** 0 **Height:** 30 **Weight:** 120 / 130 lbs **Cube:** 42.45

Materials: Guanacaste

Standard Finish: Natural **Country:** USA

Natural Guanacaste with a trapezoid metal base finished in Bronze.

8089-CS-G — Price: \$1827

Monier Chairside Table

Collection: MONIER

Width: 31.25 **Depth:** 31.25 **Height:** 24 **Weight:** 26 / 0 lbs **Cube:** 0.56

Materials: Faux-Bois Metal,Glass Top

Standard Finish: ANTIQUE GOLD **Country:** INDIA

Features a faux bois metal base finished in Antique Gold and a glass top. Consists of B-8089-CS-G (Base) and T-8089-CS-G (Top)

8089-CS-M — Price: \$1917

Monier Chairside Table

Collection: MONIER

Width: 31.25 **Depth:** 31.25 **Height:** 24 **Weight:** 78 / 78 lbs **Cube:** 14.21

Materials: Faux-Bois Metal,Calcutta Stone

Standard Finish: ANTIQUE GOLD **Country:** INDIA

8089-46-G — Price: \$2937

Monier Cocktail Table

Collection: MONIER

Width: 56 **Depth:** 32 **Height:** 18 **Weight:** 115 / 115 lbs **Cube:** 31.82

Materials: Faux-Bois Metal,Glass Top

Standard Finish: ANTIQUE GOLD **Country:** INDIA

8089-46-M — Price: \$3297

Monier Cocktail Table

Collection: MONIER

Width: 56 **Depth:** 32 **Height:** 18 **Weight:** 0 / 192 lbs **Cube:** 32.23

Materials: Faux-Bois Metal,Calcutta Stone

Standard Finish: ANTIQUE GOLD **Country:** INDIA

8089-93-G — Price: \$2967

Monier Cocktail Table

Collection: MONIER

Width: 54 **Depth:** 34.5 **Height:** 17 **Weight:** 113 / 113 lbs **Cube:** 28.49

Materials: Faux-Bois Metal,Glass Top

Standard Finish: ANTIQUE GOLD **Country:** INDIA

8089-93-M — Price: \$3387

Monier Cocktail Table

Collection: MONIER

Width: 54 **Depth:** 34.5 **Height:** 17 **Weight:** 181 / 181 lbs **Cube:** 30.48

Materials: Faux-Bois Metal,Calcutta Stone

Standard Finish: ANTIQUE GOLD **Country:** INDIA

8089-94-G — Price: \$2007

Monier End Table

Collection: MONIER

Width: 28 **Depth:** 28.5 **Height:** 24 **Weight:** 39 / 39 lbs **Cube:** 0.46

Materials: Faux-Bois Metal,Glass Top

Standard Finish: ANTIQUE GOLD **Country:** INDIA

8089-94-M — Price: \$2187

Monier End Table

Collection: MONIER

Width: 28 **Depth:** 28.5 **Height:** 24 **Weight:** 89 / 89 lbs **Cube:** 17.34

Materials: Faux-Bois Metal,Calcutta Stone

Standard Finish: ANTIQUE GOLD **Country:** INDIA

CASEGOODS

8089-99-G — Price: \$3237

Standard Finish: ANTIQUE GOLD Country: INDIA

Monier Hall Console Table

Collection: MONIER

Width: 71 **Depth:** 17.3 **Height:** 37 **Weight:** 127 / 127 lbs **Cube:** 42.29

Materials: Faux-Bois Metal, Glass Top

8089-99-M — Price: \$3627

Standard Finish: ANTIQUE GOLD Country: INDIA

Monier Hall Console Table

Collection: MONIER

Width: 71 **Depth:** 17.3 **Height:** 37 **Weight:** 189 / 189 lbs **Cube:** 40.38

Materials: Faux-Bois Metal, Calcutta Stone

M MONOGRAM

Monogram is a custom finish program for a curated selection of Fairfield casegoods in bedroom, dining room, and occasional. Options include mildly-distressed wood finishes and richly saturated premium paints - hand applied by our highly skilled American Artisans. Highlight striping in platinum or gold and contrast fronts and interiors are additional cusotm options available on select pieces.

Stain Options



Almond Buff



Antique Pinewood



Cerused Espresso



Charcoal



Dark Sable



English Honey



Flint



Hazelnut



Linen



Modern Truffle



Sheer Dove



Smoked Stone



Tobacco



Tahitian Pearl

Paint Options



American Navy

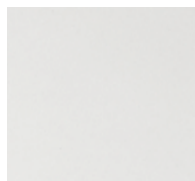

Soft White

Additional Upcharge Options Available on Select Pieces



Gold Highlight Striping



Platinum Highlight Striping



Contrast Drawers / Doors



Contrast Interior

MONOGRAM

M001-DT — Price: \$4947

MONOGRAM

Portofino Dining Table

Width: 58 Depth: 58 Height: 30 Weight: 201 / 201 lbs Cube: 24.07

Materials: White Oak Solids and Veneers

Highlight Striping: N/A Contrast Door/Drawer: N/A Country: CHINA
(1) 22" Leaf. Extended: 80x80x30. Also available as 8001-DT in Linen Finish.

M001-17 — Price: \$6267

MONOGRAM

Portofino Credenza

Width: 72 Depth: 21 Height: 38 Weight: 271 / 271 lbs Cube: 37.59

Materials: White Oak Solids and Veneers

Highlight Striping: N/A Contrast Door/Drawer: N/A Country: CHINA
Four Doors. Four Adjustable Shelves. Also available as 8001-17 in Linen Finish.

M001-81 — Price: \$4617

MONOGRAM

Portofino Desk

Width: 60 Depth: 30 Height: 30 Weight: 133 / 133 lbs Cube: 31.25

Materials: White Oak Solids and Veneers

Highlight Striping: N/A Contrast Door/Drawer: N/A Country: CHINA
Two Pencil Drawers on left and right side. One Center Drawer with drop down drawer front. Cord Management. Also available as 8001-81 in Linen Finish.

M001-84 — Price: \$4107

MONOGRAM

Portofino Lateral File

Width: 47 Depth: 22 Height: 33 Weight: 143 / 143 lbs Cube: 21.48

Materials: White Oak Solids and Veneers

Highlight Striping: N/A Contrast Door/Drawer: N/A Country: CHINA
Two Locking File drawers. Also available as 8001-84 in Linen Finish.

M037-CK — Price: \$2007

MONOGRAM

Kendrick Cocktail Table

Width: 48 Depth: 26 Height: 18 Weight: 58 / 58 lbs Cube: 13

Materials: Ash Solids and Veneers

Highlight Striping: N/A Contrast Door/Drawer: N/A Country: CHINA
Also available as 8037-CK in Modern Truffle

M037-CS — Price: \$1467

MONOGRAM

Kendrick Lamp Table

Width: 26 Depth: 26 Height: 25 Weight: 20 / 20 lbs Cube: 9.78

Materials: Ash Solids and Veneers

Highlight Striping: N/A Contrast Door/Drawer: N/A Country: CHINA
Also available as 8037-CS in Modern Truffle

M037-HT — Price: \$2097

MONOGRAM

Kendrick Console Table

Width: 56 Depth: 13.5 Height: 34 Weight: 30 / 30 lbs Cube: 14.87

Materials: Ash Solids and Veneers

Highlight Striping: N/A Contrast Door/Drawer: N/A Country: CHINA
Also available as 8037-HT in Modern Truffle

M037-95 — Price: \$1407

MONOGRAM

Kendrick End Table

Width: 20 Depth: 26 Height: 25 Weight: 16 / 16 lbs Cube: 7.52

Materials: Ash Solids and Veneers

Highlight Striping: N/A Contrast Door/Drawer: N/A Country: CHINA
Also available as 8037-95 in Modern Truffle

M063-DT — Price: \$4947

MONOGRAM

Arcadian Farmhouse Draw Leaf Dining Table

Width: 49 Depth: 30 Height: 31 Weight: 183 / 183 lbs Cube: 26.37

Materials: White Oak

Highlight Striping: N/A Contrast Door/Drawer: N/A Country: CHINA
A classic farmhouse draw table in white oak solids and veneers. Features two, self-storing leaves. Also available as 8063-DT in Burnished Oak

M066-AC — Price: \$3747

MONOGRAM

Coeurd'alone Accent Chest

Width: 50 Depth: 23 Height: 40 Weight: 185 / 185 lbs Cube: 29.67

Materials: Red Oak Solids & Veneers

Highlight Striping: \$375 Contrast Door/Drawer: N/A Country: CHINA
Five drawers with self-closing drawer guides and Antique Brass hardware. Optional highlight striping available on drawer molding. Also available as 8066-AC in Reclaimed Oak Finish.

M066-17-U — Price: \$4887

MONOGRAM

Coeurd'alone Credenza

Width: 75 Depth: 23 Height: 34 Weight: 228 / 228 lbs Cube: 40.95

Materials: Red Oak Solids & Veneers

Highlight Striping: N/A Contrast Door/Drawer: N/A Country: CHINA
Features four Blue Agate glass door panels, antique brass door trim, and acrylic and brass hardware. Interior features two adjustable shelves and cord exit holes.

M066-17-W — Price: \$4887

MONOGRAM

Coeurd'alone Credenza

Width: 75 Depth: 23 Height: 34 Weight: 228 / 228 lbs Cube: 40.95

Materials: Red Oak Solids & Veneers

Highlight Striping: N/A Contrast Door/Drawer: N/A Country: CHINA
Features four Geode glass door panels, antique brass door trim, and acrylic and brass hardware. Interior features two adjustable shelves and cord exit holes.

MONOGRAM

M066-38 — Price: \$3537

MONOGRAM

Coeurd'alene Chest

Width: 36 Depth: 16 Height: 41 Weight: 160 / 160 lbs Cube: 18.59

Materials: Red Oak Solids & Veneers

Highlight Striping: \$375 Contrast Door/Drawer: \$375 Country: CHINA

Features a removable tray top, two doors with a herring bone door panel design, Antique Brass accents, and two adjustable shelves. Optional highlight striping available on door molding. Optional contrast finish available on door fronts.

M066-86 — Price: \$2907

MONOGRAM

Coeurd'alene Entry Table

Width: 48 Depth: 48 Height: 30 Weight: 124 / 124 lbs Cube: 14.46

Materials: Red Oak Solids & Veneers

Highlight Striping: N/A Contrast Door/Drawer: N/A Country: CHINA

Features an eight piece veneer top.

M066-99 — Price: \$3987

MONOGRAM

Coeurd'alene Console Table

Width: 72 Depth: 16 Height: 32 Weight: 154 / 154 lbs Cube: 29.7

Materials: Red Oak Solids & Veneers

Highlight Striping: \$375 Contrast Door/Drawer: N/A Country: CHINA

Features a large, circular design and sculptural silhouette. Optional highlight striping available on outside edge of base molding. Also available as 8066-99 in French Oak Finish.

M067-TB — Price: \$3507

MONOGRAM

Serpentine Shaped Leg Dining Pedestal Base

Width: 36 Depth: 36 Height: 28.5 Weight: 52 / 52 lbs Cube: 26.32

Materials: Walnut Solids & Veneers

Highlight Striping: N/A Contrast Door/Drawer: N/A Country: CHINA
Features metal ferrules finished in Nickel. Pairs with M067-48 and M067-60 Monogram Beveled Edge Dining Table Tops. Also available as 8067-TB in Sheer Dove Finish.

M067-48 — Price: \$2487

MONOGRAM

Beveled Edge 48" Dining Table Top

Width: 48 Depth: 48 Height: 30 Weight: 71 / 71 lbs Cube: 40

Materials: Walnut Solids & Veneers

Highlight Striping: \$375 Contrast Door/Drawer: N/A Country: CHINA

48" round table top with a pie-shaped veneer design and beveled edge. Optional highlight striping available on bottom of apron. Pairs with M067-TB, Monogram Serpentine Shaped Leg Dining Pedestal Base. Also available as 8067-48 in Sheer Dove Finish.

M067-60 — Price: \$3087

MONOGRAM

Beveled Edge 60" Dining Table Top

Width: 60 Depth: 60 Height: 30 Weight: 198 / 198 lbs Cube: 10.01

Materials: Walnut Solids & Veneers

Highlight Striping: \$375 Contrast Door/Drawer: N/A Country: CHINA

60" round table top with a pie-shaped veneer design and beveled edge. Optional highlight striping available on bottom of apron. Pairs with M067-TB, Serpentine Shaped Leg Dining Pedestal Base. Also available as 8067-60 in Sheer Dove Finish.

M069-TB — Price: \$2847

MONOGRAM

C-Ring Pedestal Base

Width: 32.5 Depth: 32.5 Height: 29 Weight: 50 / 50 lbs Cube: 22.33

Materials: Walnut Solids & Veneers

Highlight Striping: N/A Contrast Door/Drawer: N/A Country: CHINA

Features Nickel caps at the base. Pairs with M067-48 and M067-60, Monogram Beveled Edge Dining Table Tops. Also available as 8069-TB in Sheer Dove Finish.

M080-ET — Price: \$1737

MONOGRAM

Helena Nesting Table

Width: 22 Depth: 22 Height: 25 Weight: 21 / 21 lbs Cube: 7

Materials: Ash Solids and Veneers

Highlight Striping: N/A Contrast Door/Drawer: N/A Country: CHINA

Also available as 8080-ET-C in Charcoal

M080-90 — Price: \$1797

MONOGRAM

Helena End Table

Width: 24 Depth: 24 Height: 24 Weight: 39 / 39 lbs Cube: 8

Materials: Ash Solids and Veneers

Highlight Striping: N/A Contrast Door/Drawer: N/A Country: CHINA

Also available as 8080-90-C in Charcoal

M080-99 — Price: \$2697

MONOGRAM

Helena Console Table

Width: 52 Depth: 18 Height: 34 Weight: 83 / 83 lbs Cube: 18.41

Materials: Ash Solids and Veneers

Highlight Striping: N/A Contrast Door/Drawer: N/A Country: CHINA

Also available as 8080-99-C in Charcoal

M084-CH — Price: \$3687

MONOGRAM

Lizzie Chest

Width: 43 Depth: 23 Height: 38 Weight: 154 / 154 lbs Cube: 28.68

Materials: Maple Solids & Veneers

Highlight Striping: \$450 Contrast Door/Drawer: \$375 Country: CHINA

Features four drawers with an Antique Brass metal overlay on the fronts and Antique Brass hardware. Optional highlight striping available on drawer grills. Optional contrast finish available on drawer fronts. Also available as 8084-CH in Flint finish.

M092-CH — Price: \$4287

MONOGRAM

Cheñeais Chest

Width: 48 Depth: 19 Height: 38 Weight: 217 / 217 lbs Cube: 30.46

Materials: Select Red Oak Solids & Veneers

Highlight Striping: N/A Contrast Door/Drawer: N/A Country: CHINA

Features three antiqued mirrored drawer panels beneath an intricate, wood-cut overlay.

MONOGRAM

M092-DT — Price: \$8397

MONOGRAM

Cheñeais Dining Table

Width: 90 **Depth:** 46 **Height:** 30 **Weight:** 487 / 487 lbs **Cube:** 82.18

Materials: Select Red Oak Solids & Veneers

Highlight Striping: N/A **Contrast Door/Drawer:** N/A **Country:** CHINA
Features two 22" leaves. Consists of M092-DT-B (Base) and M092-DT-T (Top).
Also available as 8092-DT in French Oak Finish.

M092-17 — Price: \$8487

MONOGRAM

Cheñeais Credenza

Width: 84 **Depth:** 19 **Height:** 38 **Weight:** 351 / 351 lbs **Cube:** 48.05

Materials: Select Red Oak Solids & Veneers

Highlight Striping: N/A **Contrast Door/Drawer:** N/A **Country:** CHINA
Features an inset stone top, three doors, two interior drawers, and four interior adjustable shelves. Hardware finished in Oiled Antique Bronze. Also available as 8092-17 French Oak Finish.

M092-19 — Price: \$2577

MONOGRAM

Cheñeais End Table

Width: 25 **Depth:** 25 **Height:** 25 **Weight:** 64 / 64 lbs **Cube:** 13.36

Materials: Select Red Oak Solids & Veneers

Highlight Striping: N/A **Contrast Door/Drawer:** N/A **Country:** CHINA
Features an inset stone top and one fixed shelf. Also available as 8092-19 finish in French Oak.

M092-92 — Price: \$4287

MONOGRAM

Cheñeais Square Cocktail Table

Width: 48 **Depth:** 48 **Height:** 20 **Weight:** 175 / 175 lbs **Cube:** 34.61

Materials: Select Red Oak Solids & Veneers

Highlight Striping: N/A **Contrast Door/Drawer:** N/A **Country:** CHINA
Features an inset glass top and decorative metal stretcher. Also available as 8092-92 finish in French Oak.

M092-95 — Price: \$2097

MONOGRAM

Cheñeais Chairside Table

Width: 26 **Depth:** 16 **Height:** 24 **Weight:** 63 / 63 lbs **Cube:** 9.24

Materials: Select Red Oak Solids & Veneers

Highlight Striping: N/A **Contrast Door/Drawer:** N/A **Country:** CHINA
Features one pull-out tray, three fixed shelves, and casters.

M092-98 — Price: \$2067

MONOGRAM

Cheñeais Round Lamp Table

Width: 25 **Depth:** 25 **Height:** 26 **Weight:** 56 / 56 lbs **Cube:** 14.57

Materials: Select Red Oak Solids & Veneers

Highlight Striping: N/A **Contrast Door/Drawer:** N/A **Country:** CHINA
Features one fixed shelf. Also available as 8092-98 finish in French Oak.

M096-CS — Price: \$1437

MONOGRAM

West Camden End Table

Width: 16 **Depth:** 28 **Height:** 24 **Weight:** 46 / 46 lbs **Cube:** 9.12

Materials: Walnut Solids and Veneers

Highlight Striping: N/A **Contrast Door/Drawer:** N/A **Country:** CHINA
Features one pull-out shelf and two fixed shelves. Also available as 8096-CS in Tahitian Pearl.

M096-CT — Price: \$2097

MONOGRAM

West Camden Round Cocktail Table

Width: 44 **Depth:** 44 **Height:** 19 **Weight:** 81 / 81 lbs **Cube:** 8.22

Materials: Metal, Walnut Solids and Veneers

Highlight Striping: N/A **Contrast Door/Drawer:** N/A **Country:** CHINA
Black Steel metal. Also available as 8096-CT in Tahitian Pearl.

M096-DT — Price: \$5247

MONOGRAM

West Camden Round Dining Table

Width: 72 **Depth:** 72 **Height:** 30 **Weight:** 272 / 272 lbs **Cube:** 0

Materials: Walnut Solids and Veneers

Highlight Striping: N/A **Contrast Door/Drawer:** N/A **Country:** CHINA
72" round dining table top. Consist of 8096-DT-B (Base) and 8096-DT-T (Top).
Also available as 8096-DT-T in Tahitian Pearl.

M096-ET — Price: \$1437

MONOGRAM

West Camden End Table

Width: 22 **Depth:** 22 **Height:** 24 **Weight:** 35 / 35 lbs **Cube:** 9.74

Materials: Metal, Walnut Solids and Veneers

Highlight Striping: N/A **Contrast Door/Drawer:** N/A **Country:** CHINA
Black Steel metal frame. Also available as 8096-ET in Tahitian Pearl.

M096-HT — Price: \$1647

MONOGRAM

West Camden Console Table

Width: 46 **Depth:** 14 **Height:** 34 **Weight:** 45 / 45 lbs **Cube:** 5.14

Materials: Walnut Solids and Veneers

Highlight Striping: N/A **Contrast Door/Drawer:** N/A **Country:** CHINA
Black Steel metal frame. Also available as 8096-HT in Tahitian Pearl.

M096-ST — Price: \$3747

MONOGRAM

West Camden Three Drawer Console

Width: 72 **Depth:** 16 **Height:** 34 **Weight:** 145 / 145 lbs **Cube:** 11.48

Materials: Walnut Solids and Veneers, Stone

Highlight Striping: N/A **Contrast Door/Drawer:** N/A **Country:** CHINA
Features Three finger pull, soft close drawers and a White Carrara stone top.
Also available as 8096-ST in Tahitian Pearl.

MONOGRAM

M096-16 — Price: \$2187

MONOGRAM

West Camden Dining Table Base

Width: 30 **Depth:** 30 **Height:** 29.5 **Weight:** 67 / 67 lbs **Cube:** 18.08

Materials: Metal, Walnut Solids and Veneers

Highlight Striping: N/A **Contrast Door/Drawer:** N/A **Country:** CHINA
Black Steel metal. Also available as 8096-16 in Tahitian Pearl.

M096-19 — Price: \$1497

MONOGRAM

West Camden Round End Table

Width: 22 **Depth:** 22 **Height:** 24 **Weight:** 44 / 44 lbs **Cube:** 10.36

Materials: Metal, Walnut Solids and Veneers

Highlight Striping: N/A **Contrast Door/Drawer:** N/A **Country:** CHINA
Black Steel metal. Also available as 8096-19 in Tahitian Pearl.

M096-38 — Price: \$3237

MONOGRAM

West Camden Drawer Chest

Width: 36 **Depth:** 20 **Height:** 32 **Weight:** 110 / 110 lbs **Cube:** 13.33

Materials: Metal, Walnut Solids and Veneers

Highlight Striping: N/A **Contrast Door/Drawer:** N/A **Country:** CHINA
Features three, scalloped-carved drawer fronts with Black Steel hardware and base. Also available as 8096-38 in Tahitian Pearl.

M096-44 — Price: \$4797

MONOGRAM

West Camden Dining Table

Width: 60 **Depth:** 60 **Height:** 32 **Weight:** 262 / 262 lbs **Cube:** 15.57

Materials: Walnut Solids and Veneers

Highlight Striping: N/A **Contrast Door/Drawer:** N/A **Country:** CHINA
Features One 22" leaf. Pairs with 8096-44-B West Camden base. Also available as 8096-44-T in Tahitian Pearl.

M096-82 — Price: \$5097

MONOGRAM

West Camden Credenza

Width: 78 **Depth:** 20 **Height:** 34 **Weight:** 293 / 293 lbs **Cube:** 30.69

Materials: Walnut Solids and Veneers

Highlight Striping: N/A **Contrast Door/Drawer:** N/A **Country:** CHINA
Features Four doors with an adjustable shelf behind each door. Black Steel hardware. Also available as 8096-82 in Tahitian Pearl.

M096-93 — Price: \$1647

MONOGRAM

West Camden Rectangular Cocktail Table

Width: 42 **Depth:** 20 **Height:** 18 **Weight:** 45 / 45 lbs **Cube:** 4.67

Materials: Metal, Walnut Solids and Veneers

Highlight Striping: N/A **Contrast Door/Drawer:** N/A **Country:** CHINA
Black Steel metal frame. Also available as 8096-93 in Tahitian Pearl.

M096-94 — Price: \$1197

MONOGRAM

West Camden Drink Table

Width: 14 **Depth:** 14 **Height:** 22 **Weight:** 23 / 23 lbs **Cube:** 4.09

Materials: Metal, Walnut Solids and Veneers

Highlight Striping: N/A **Contrast Door/Drawer:** N/A **Country:** CHINA
Black Steel metal frame. Also available as 8096-94 in Tahitian Pearl.

M096-96 — Price: \$4797

MONOGRAM

West Camden Credenza

Width: 72 **Depth:** 20 **Height:** 34 **Weight:** 256 / 256 lbs **Cube:** 28.33

Materials: Metal, Walnut Solids and Veneers

Highlight Striping: N/A **Contrast Door/Drawer:** N/A **Country:** CHINA
Features two doors with two interior adjustable shelves. Metal base and hardware in Black Steel finish. Also available as 8096-96 in Tahitian Pearl.

M096-97 — Price: \$3777

MONOGRAM

West Camden Drawer Chest

Width: 42 **Depth:** 20 **Height:** 40 **Weight:** 143 / 143 lbs **Cube:** 19.44

Materials: Metal, Walnut Solids and Veneers

Highlight Striping: N/A **Contrast Door/Drawer:** N/A **Country:** CHINA
Features five reeded-front drawers with self-closing drawer guides and acrylic and Black Steel hardware. Also available as 8096-97 in Tahitian Pearl.

M098-AC — Price: \$3537

MONOGRAM

East Camden Accent Chest

Width: 38 **Depth:** 20 **Height:** 33 **Weight:** 109 / 109 lbs **Cube:** 19.4

Materials: Poplar Solids & Veneers

Highlight Striping: N/A **Contrast Door/Drawer:** N/A **Country:** CHINA
Features three drawers with self-closing drawer guides and concave fluted drawer fronts with Antique Brass hardware. Also available as 8098-AC in Pearl Finish.

M098-38 — Price: \$3537

MONOGRAM

East Camden Chest

Width: 36 **Depth:** 20 **Height:** 32 **Weight:** 112 / 112 lbs **Cube:** 18.27

Materials: Poplar Solids & Veneers with a Metal Base

Highlight Striping: N/A **Contrast Door/Drawer:** N/A **Country:** CHINA
Features three, scalloped-carved drawer fronts with Antique Brass hardware and base. Also available as 8098-38 in Pearl Finish.

M098-97 — Price: \$4137

MONOGRAM

East Camden Chest

Width: 42 **Depth:** 20 **Height:** 40 **Weight:** 121 / 121 lbs **Cube:** 25.75

Materials: Poplar Solids & Veneers

Highlight Striping: N/A **Contrast Door/Drawer:** N/A **Country:** CHINA
Features five reeded-front drawers with self-closing drawer guides and acrylic and Antique Brass hardware. Also available as 8098-97 in Pearl Finish.

MONOGRAM

M181-48 — Price: \$6897

MONOGRAM

Sundries Bar Cabinet

Width: 36 **Depth:** 19 **Height:** 70 **Weight:** 216 / 216 lbs **Cube:** 27.7

Materials: Quartered Ash Solids & Veneers

Highlight Striping: \$375 **Contrast Door/Drawer:** N/A **Country:** CHINA

Features two doors, two interior drawers, mirrored back panel, pull-out shelf, LED lighting, bottle and stemware storage. Doors open to 270 degrees. Optional highlight striping available on outside edge of the drawer frame. Brushed Brass Metal. Also available as 8181-48 in Sheer Dove Finish.

M189-AC — Price: \$4197

MONOGRAM

Expedition Chest

Width: 41.25 **Depth:** 19.25 **Height:** 34 **Weight:** 130 / 130 lbs **Cube:** 20.72

Materials: Figured Eucalyptus & Oak Solids

Highlight Striping: \$375 **Contrast Door/Drawer:** \$375 **Country:** CHINA

Features a rectangular wood case with three drawers mounted with cast brass bar pulls. The black, cast iron base features linear corner legs joined by a low X-stretcher. Optional Highlight Striping available on outside edge of chest frame. Optional contrast finish on drawer fronts available. Also available as 8189-AC in Grecian Clay.

M189-AD — Price: \$3597

MONOGRAM

Expedition Console

Width: 60 **Depth:** 15.25 **Height:** 34 **Weight:** 119 / 119 lbs **Cube:** 26.4

Materials: Figured Eucalyptus & Oak Solids

Highlight Striping: N/A **Contrast Door/Drawer:** \$375 **Country:** CHINA

Three Drawers. Also available as 8189-AD in Grecian Clay.

M189-CC — Price: \$2097

MONOGRAM

Expedition Chairside Chest

Width: 14 **Depth:** 22 **Height:** 23 **Weight:** 63 / 63 lbs **Cube:** 7.62

Materials: Figured Eucalyptus & Oak Solids

Highlight Striping: N/A **Contrast Door/Drawer:** \$375 **Country:** CHINA

Two Drawers. Optional contrast finish on drawer fronts available. Cast Iron Base. Also available as 8189-CC in Grecian Clay.

M189-CH — Price: \$4197

MONOGRAM

Expedition Chest

Width: 49 **Depth:** 18.75 **Height:** 34 **Weight:** 130 / 130 lbs **Cube:** 23.93

Materials: Figured Eucalyptus & Oak Solids

Highlight Striping: \$375 **Contrast Door/Drawer:** \$375 **Country:** CHINA

Features a rectangular wood case with two storage drawers veneered in a herringbone pattern. Cast iron metal base with gracefully tapered corner legs. Optional Highlight Striping available on inner drawer frame molding and reveal beneath the table top. Optional contrast finish on drawer fronts available. Also available as 8189-CH in Grecian Clay.

M189-HT — Price: \$2187

MONOGRAM

Expedition Hall Console Table

Width: 56 **Depth:** 16 **Height:** 32 **Weight:** 77 / 77 lbs **Cube:** 5.27

Materials: Figured Eucalyptus & Oak Solids

Highlight Striping: N/A **Contrast Door/Drawer:** \$375 **Country:** CHINA

Metal Accents. Lower Shelf. Also available as 8189-HT in Grecian Clay.

M189-13 — Price: \$2247

MONOGRAM

Expedition Round Cocktail Table

Width: 42 **Depth:** 42 **Height:** 18 **Weight:** 88 / 88 lbs **Cube:** 6.84

Materials: Figured Eucalyptus & Oak Solids

Highlight Striping: N/A **Contrast Door/Drawer:** \$375 **Country:** CHINA

Metal Accents. Lower Shelf. Also available as 8189-13 in Grecian Clay.

M189-19 — Price: \$1737

MONOGRAM

Expedition Round End Table

Width: 25 **Depth:** 25 **Height:** 25 **Weight:** 51 / 51 lbs **Cube:** 3.4

Materials: Figured Eucalyptus & Oak Solids

Highlight Striping: N/A **Contrast Door/Drawer:** \$375 **Country:** CHINA

Metal Accents. Finished. Also available as 8189-19 in Grecian Clay.

M189-81 — Price: \$5847

MONOGRAM

Expedition Pedestal Desk

Width: 60 **Depth:** 28 **Height:** 30 **Weight:** 234 / 234 lbs **Cube:** 38.16

Materials: Figured Eucalyptus & Oak Solids

Highlight Striping: \$450 **Contrast Door/Drawer:** \$375 **Country:** CHINA

Includes a center keyboard drawer, two pencil drawers and two storage drawers, two lateral file drawers, cast brass hardware, and two grommets for cord management in the desktop. Optional Highlight Striping available on outside edge of desk frame and outer edge of drawer frame. Optional contrast finish on drawer fronts available. Also available as 8189-81 in Grecian Clay.

M189-88 — Price: \$1407

MONOGRAM

Expedition Martini Table

Width: 17.75 **Depth:** 17.75 **Height:** 23 **Weight:** 29 / 29 lbs **Cube:** 2.11

Materials: Figured Eucalyptus & Oak Solids

Highlight Striping: N/A **Contrast Door/Drawer:** \$375 **Country:** CHINA

Metal Accents. Finished. Also available as 8189-88 in Grecian Clay.

M189-91 — Price: \$4047

MONOGRAM

Expedition Cocktail Table

Width: 50 **Depth:** 30 **Height:** 19 **Weight:** 138 / 138 lbs **Cube:** 23.2

Materials: Figured Eucalyptus & Oak Solids

Highlight Striping: N/A **Contrast Door/Drawer:** \$375 **Country:** CHINA

A low table designed with a rectangular wood case veneered in richly figured eucalyptus. Three storage drawers on one side with cast brass hardware and a cast iron base with linear corner legs joined by a low X-stretcher. Optional contrast finish on drawer fronts available. Also available as 8189-91 in Grecian Clay.

M189-95 — Price: \$2697

MONOGRAM

Expedition End Table

Width: 22 **Depth:** 28 **Height:** 26 **Weight:** 81 / 81 lbs **Cube:** 13.88

Materials: Figured Eucalyptus & Oak Solids, Cast Iron Base

Highlight Striping: N/A **Contrast Door/Drawer:** \$375 **Country:** CHINA

Eucalyptus veneered case housing a storage drawer and mounted with cast brass hardware on a cast iron base with a low X-stretcher. Optional contrast finish on drawer fronts available. Also available as 8189-95 in Grecian Clay.

MONOGRAM

M189-96 — Price: \$3897

MONOGRAM

Expedition Console

Width: 56 **Depth:** 16 **Height:** 34 **Weight:** 104 / 104 lbs **Cube:** 24.96

Materials: Figured Eucalyptus & Oak Solids,Cast Iron Base

Highlight Striping: N/A **Contrast Door/Drawer:** \$375 **Country:** CHINA
Eucalyptus veneered case housing three storage drawers and mounted with cast brass hardware on a cast iron base with a low X-stretcher. Optional contrast finish on drawer fronts available. Also available as 8189-95 in Grecian Clay.

M189-99 — Price: \$2397

MONOGRAM

Expedition Sofa Table

Width: 40 **Depth:** 11 **Height:** 32 **Weight:** 55 / 55 lbs **Cube:** 12.62

Materials: Figured Eucalyptus & Oak Solids

Highlight Striping: N/A **Contrast Door/Drawer:** \$375 **Country:** CHINA
Also available as 8189-99 in Grecian Clay.

M191-MF — Price: \$1887

MONOGRAM

Park Avenue Mobile File

Width: 15.5 **Depth:** 18 **Height:** 24.75 **Weight:** 92 / 92 lbs **Cube:** 6.38

Materials: Oak Solids, Figured Eucalyptus Veneer,Metal

Highlight Striping: N/A **Contrast Door/Drawer:** N/A **Country:** CHINA
Includes hidden casters and one standard top drawer and one bottom lateral file drawer with a hidden pencil drawer. Fits under the 8191-81 Park Avenue Desk and M191-81 Monogram Park Avenue Desk. Also available as 8191-MF in Grecian Clay.

M191-81 — Price: \$4797

MONOGRAM

Park Avenue Desk

Width: 64 **Depth:** 20 **Height:** 36.5 **Weight:** 160 / 160 lbs **Cube:** 44.31

Materials: Oak Solids, Figured Eucalyptus Veneer,Metal

Highlight Striping: N/A **Contrast Door/Drawer:** N/A **Country:** CHINA
Three drawers, center drawer with pencil tray and standard outlet with USB port. Also available as 8191-81 in Grecian Clay.

M191-84 — Price: \$3597

MONOGRAM

Park Avenue Lateral File

Width: 36 **Depth:** 19 **Height:** 29 **Weight:** 152 / 152 lbs **Cube:** 15.88

Materials: Oak Solids, Figured Eucalyptus Veneer,Metal

Highlight Striping: N/A **Contrast Door/Drawer:** N/A **Country:** CHINA
Two drawers with lateral files, two doors with interior printer storage, and a standard outlet with a USB port. Also available as 8191-84 in Grecian Clay.

M200-DT — Price: \$5247

MONOGRAM

Essa Trestle Dining Table

Width: 92 **Depth:** 42 **Height:** 30 **Weight:** 243 / 243 lbs **Cube:** 67.08

Materials: Ash Solids and Veneers

Highlight Striping: N/A **Contrast Door/Drawer:** N/A **Country:** CHINA
Also available as 4200-DT-A Antique Pinewood Finish and 4200-DT-E English Honey Finish.

M201-DT — Price: \$5397

BD COLLECTION FOR FAIRFIELD, MONOGRAM

Cooper Dining Table

Width: 90 **Depth:** 42 **Height:** 30 **Weight:** 280 / 280 lbs **Cube:** 65.62

Materials: Ash Solids and Veneers

Highlight Striping: N/A **Contrast Door/Drawer:** N/A **Country:** CHINA
Features two 18" Leaves. Width with one 18" leaf is 108" and with two 18" leaves is 126" Full Extended Dimensions: 126" x 42" x 31". Also available as 4201-DT-A Antique Pinewood Finish and 4201-DT-E English Honey Finish.

M305-18 — Price: \$8847

BD COLLECTION FOR FAIRFIELD, MONOGRAM

Pamela Curio Cabinet

Width: 60 **Depth:** 20 **Height:** 84 **Weight:** 318 / 318 lbs **Cube:** 65.38

Materials: Ash Solids and Veneers

Highlight Striping: N/A **Contrast Door/Drawer:** N/A **Country:** CHINA
Features Six Drawers, Two Wooden shelves with plate grooves. Nine display areas. Also available as 4305-18 Antique Pinewood Finish, 4306-18 English Honey Finish, 4312-18 Soft White Finish.

M307-18 — Price: \$8097

BD COLLECTION FOR FAIRFIELD, MONOGRAM

Edward Curio Cabinet

Width: 48 **Depth:** 17 **Height:** 84 **Weight:** 328 / 328 lbs **Cube:** 38.18

Materials: Ash Solids and Veneers

Highlight Striping: N/A **Contrast Door/Drawer:** \$300 **Country:** CHINA
Features Three Drawers. Two Glass inset Doors. Two Wooden Shelves. Contrasting interior finish available at an additional charge. Also available as 4307-18 Antique Pinewood Finish, 4308-18 English Honey Finish, 4313-18 Iron Ore/Soft White contrasting interior Finish.

M308-ET — Price: \$1947

MONOGRAM

Marlowe Tiered Round End Table

Width: 26 **Depth:** 26 **Height:** 25 **Weight:** 51 / 51 lbs **Cube:** 9.78

Materials: Stainless Steel,Walnut Solids and Veneers

Highlight Striping: N/A **Contrast Door/Drawer:** N/A **Country:** CHINA
Features one top with Walnut veneers and a lower antique mirror shelf, Smoked Stone and Champagne Metal. Also available in any Monogram Finish as M308-ET.

M308-13 — Price: \$2247

MONOGRAM

Marlowe Tiered Round Cocktail Table

Width: 42 **Depth:** 42 **Height:** 18 **Weight:** 77 / 77 lbs **Cube:** 18.37

Materials: Stainless Steel, Walnut Solids and Veneers

Highlight Striping: N/A **Contrast Door/Drawer:** N/A **Country:** CHINA
Features one top with Walnut veneers and a lower antique mirror shelf and Champagne Metal. Also available as 6308-13 in Smoked Stone and Champagne Metal.

M309-18 — Price: \$9597

BD COLLECTION FOR FAIRFIELD, MONOGRAM

Alexander Curio Cabinet

Width: 68 **Depth:** 17.5 **Height:** 84.25 **Weight:** 274 / 274 lbs **Cube:** 65.86

Materials: Ash Solids and Veneers

Highlight Striping: N/A **Contrast Door/Drawer:** \$300 **Country:** CHINA
Features Two Drawers. Two Wood Framed Glass Doors. Two Adjustable Shelves. Contrasting interior finish available at an additional charge. Also available as 4309-18 Pinewood Finish, 4310-18 English Honey Finish, 4311-18 Soft White Finish.

MONOGRAM

M315-19 — Price: \$1497

MONOGRAM

Zeller End Table

Width: 24 Depth: 24 Height: 24 Weight: 32 / 32 lbs Cube: 8

Materials: Stainless Steel, Ash Solids and Veneers

Highlight Striping: N/A **Contrast Door/Drawer:** N/A **Country:** CHINA
Also available as 6315-19 in Smoked Stone Finish.

M316-96 — Price: \$2847

MONOGRAM

Simone Writing Desk

Width: 60 Depth: 22 Height: 30 Weight: 96 / 96 lbs Cube: 22.91

Materials: Stainless Steel, Acrylic, Walnut Solids and Veneers

Highlight Striping: N/A **Contrast Door/Drawer:** N/A **Country:** CHINA
Features two drawers with soft close guides. Also available as 6316-96 in Smoked Stone Finish.

M317-DT — Price: \$3897

MONOGRAM

Clement Dining Table

Width: 76 Depth: 40 Height: 30 Weight: 320 / 320 lbs Cube: 52.77

Materials: Stainless Steel, Oak Solids and Eucalyptus Veneers

Highlight Striping: N/A **Contrast Door/Drawer:** N/A **Country:** CHINA
Features one 24" filler. Also available as 6317-DT in Smoked Stone Finish.

M322-CH — Price: \$3807

MONOGRAM

Farley Five Drawer Chest

Width: 36 Depth: 20 Height: 55 Weight: 222 / 222 lbs Cube: 22.91

Materials: Walnut Solids and Veneers

Highlight Striping: N/A **Contrast Door/Drawer:** N/A **Country:** CHINA
Also available as 6322-CH in Smoked Stone

M322-ET — Price: \$2697

MONOGRAM

Farley Small End Table

Width: 28 Depth: 20 Height: 28 Weight: 108 / 108 lbs Cube: 9.07

Materials: Walnut Solids and Veneers

Highlight Striping: N/A **Contrast Door/Drawer:** N/A **Country:** CHINA
Also available as 6322-ET in Smoked Stone

M322-KB — Price: \$4197

MONOGRAM

Farley King Bed

Width: 80 Depth: 84.5 Height: 67 Weight: 320 / 320 lbs Cube: 262.1

Materials: Walnut Solids and Veneers

Highlight Striping: N/A **Contrast Door/Drawer:** N/A **Country:** CHINA
Also available as 6322-KB in Smoked Stone

M322-QB — Price: \$3897

MONOGRAM

Farley Queen Bed

Width: 64 Depth: 84.5 Height: 67 Weight: 254 / 254 lbs Cube: 209.68

Materials: Walnut Solids and Veneers

Highlight Striping: N/A **Contrast Door/Drawer:** N/A **Country:** CHINA
Also available as 6322-QB in Smoked Stone

M322-17 — Price: \$4197

MONOGRAM

Farley Six Drawer Chest

Width: 78 Depth: 20 Height: 37 Weight: 293 / 293 lbs Cube: 33.4

Materials: Walnut Solids and Veneers

Highlight Striping: N/A **Contrast Door/Drawer:** N/A **Country:** CHINA
Also available as 6322-17 in Smoked Stone

M322-38 — Price: \$2997

MONOGRAM

Farley Large End Table

Width: 36 Depth: 20 Height: 28 Weight: 141 / 141 lbs Cube: 11.66

Materials: Walnut Solids and Veneers

Highlight Striping: N/A **Contrast Door/Drawer:** N/A **Country:** CHINA
Also available as 6322-38 in Smoked Stone

M400-TB — Price: \$2487

MONOGRAM

Garnett Table Base

Width: 30 Depth: 30 Height: 27.75 Weight: 42 / 42 lbs Cube: 14.45

Materials: Alder Solids

Highlight Striping: N/A **Contrast Door/Drawer:** N/A **Country:** CHINA
Also available as 4400-TB in Antique Pinewood

M401-TB — Price: \$2577

BD COLLECTION FOR FAIRFIELD, MONOGRAM

Zoey Table Base

Width: 27.5 Depth: 24 Height: 24 Weight: 31 / 31 lbs Cube: 9.16

Materials: Alder Solids

Highlight Striping: N/A **Contrast Door/Drawer:** N/A **Country:** CHINA
Also available as 4401-TB-A Antique Pinewood Finish, 4401-TB-E English Honey Finish.

M402-TB — Price: \$1977

BD COLLECTION FOR FAIRFIELD, MONOGRAM

Sycamore Table Base

Width: 28 Depth: 24 Height: 24 Weight: 46 / 46 lbs Cube: 9.33

Materials: Alder Solids

Highlight Striping: N/A **Contrast Door/Drawer:** N/A **Country:** CHINA
Also available as 4402-TB-A Antique Pinewood Finish, 4402-TB-E English Honey Finish.

MONOGRAM

M403-TB — Price: \$1977

BD COLLECTION FOR FAIRFIELD, MONOGRAM

Estelle Table Base

Width: 24 Depth: 24 Height: 28.75 Weight: 29 / 29 lbs Cube: 9.58

Materials: Alder Solids

Highlight Striping: N/A Contrast Door/Drawer: N/A Country: CHINA

Also available as 4403-TB-A Antique Pinewood Finish, 4403-TB-E English Honey Finish.

M424-TP — Price: \$1977

BD COLLECTION FOR FAIRFIELD, MONOGRAM

Karen Table Top

Width: 36 Depth: 24 Height: 1.25 Weight: 29 / 29 lbs Cube: 0.62

Materials: Alder Solids and Birch Veneers

Highlight Striping: N/A Contrast Door/Drawer: N/A Country: CHINA

Corner Key Design. Eased Edge. Also available as 4424-TP-A Antique Pinewood Finish, 4424-TP-E English Honey Finish.

M426-TP — Price: \$1407

BD COLLECTION FOR FAIRFIELD, MONOGRAM

Ava Table Top

Width: 36 Depth: 24 Height: 1.25 Weight: 29 / 29 lbs Cube: 0.62

Materials: Alder Solids and Birch Veneers

Highlight Striping: N/A Contrast Door/Drawer: N/A Country: CHINA

Quilt Inlay Design. Eased Edge. Also available as 4426-TP-A Antique Pinewood Finish, 4426-TP-E English Honey Finish.

M444-TP — Price: \$1977

BD COLLECTION FOR FAIRFIELD, MONOGRAM

Karen Table Top

Width: 42 Depth: 42 Height: 1.25 Weight: 75 / 75 lbs Cube: 1.27

Materials: Alder Solids and Birch Veneers

Highlight Striping: N/A Contrast Door/Drawer: N/A Country: CHINA

Corner Key Design. Eased Edge. Also available as 4444-TP-A Antique Pinewood Finish, 4444-TP-E English Honey Finish.

M446-TP — Price: \$2097

BD COLLECTION FOR FAIRFIELD, MONOGRAM

Ava Table Top

Width: 42 Depth: 42 Height: 1.25 Weight: 75 / 75 lbs Cube: 1.27

Materials: Alder Solids and Birch Veneers

Highlight Striping: N/A Contrast Door/Drawer: N/A Country: CHINA

Quilt Inlay Design. Eased Edge. Also available as 4426-TP-A Antique Pinewood Finish, 4426-TP-E-E English Honey Finish.

M463-TP — Price: \$3207

BD COLLECTION FOR FAIRFIELD, MONOGRAM

Carol Table Top

Width: 60 Depth: 60 Height: 1.25 Weight: 122 / 122 lbs Cube: 2.6

Materials: Alder Solids and Birch Veneers

Highlight Striping: N/A Contrast Door/Drawer: N/A Country: CHINA

Herringbone Design. Ogee Edge. Also available as 4463-TP-A Antique Pinewood Finish, 4463-TP-E English Honey Finish.

M464-TP — Price: \$3207

BD COLLECTION FOR FAIRFIELD, MONOGRAM

Ava Table Top

Width: 60 Depth: 60 Height: 1.25 Weight: 122 / 122 lbs Cube: 2.6

Materials: Alder Solids and Birch Veneers

Highlight Striping: N/A Contrast Door/Drawer: N/A Country: CHINA

Quilt Inlay Design. Ogee Edge. Also available as 4464-TP-A Antique Pinewood Finish, 4464-TP-E English Honey Finish.

M701-92 — Price: \$2847

MONOGRAM

Peconic Square Cocktail Table

Width: 40 Depth: 40 Height: 18 Weight: 75 / 75 lbs Cube: 23

Materials: Quartered Ash Solids & Veneers

Highlight Striping: N/A Contrast Door/Drawer: N/A Country: CHINA

Also available as 6701-92 in Sheer Dove Finish.

M703-12 — Price: \$3147

MONOGRAM

Gansett Nesting Cocktail Table

Width: 48 Depth: 28 Height: 19 Weight: 120 / 120 lbs Cube: 20.73

Materials: Ash Solids

Highlight Striping: N/A Contrast Door/Drawer: N/A Country: CHINA

Large table: glass top. Small table: white Carrara Stone top. Also available as 6703-12 in Dark Sable

M721-47 — Price: \$2007

MONOGRAM

Wheelock End Table

Width: 28 Depth: 22 Height: 24 Weight: 37 / 37 lbs Cube: 11.8

Materials: Quartered Ash Solids & Veneers

Highlight Striping: N/A Contrast Door/Drawer: N/A Country: CHINA

Oval wood top with a curved, metal base in Dark Bronze. Also available as 6721-47 in Sheer Dove Finish.

M722-19 — Price: \$2697

MONOGRAM

Oakleigh End Table

Width: 28 Depth: 28 Height: 24 Weight: 46 / 46 lbs Cube: 3.89

Materials: Birch Solids & Walnut Veneers

Highlight Striping: N/A Contrast Door/Drawer: N/A Country: CHINA

One fixed shelf. Also available as 6721-47 in Dark Sable Finish.

M723-36 — Price: \$2787

MONOGRAM

Foster Right Side Facing Open End Table

Width: 30 Depth: 20 Height: 26 Weight: 114 / 114 lbs Cube: 12.48

Materials: Birch Solids & Walnut Veneers

Highlight Striping: N/A Contrast Door/Drawer: N/A Country: CHINA

One soft-close drawer and two fixed shelves.

MONOGRAM

M723-37 — Price: \$2787

MONOGRAM

Foster Left Side Facing Open End Table

Width: 30 **Depth:** 20 **Height:** 26 **Weight:** 114 / 114 lbs **Cube:** 12.48

Materials: Birch Solids & Walnut Veneers

Highlight Striping: N/A **Contrast Door/Drawer:** N/A **Country:** CHINA

One soft-close drawer and two fixed shelves. Also available as 6723-37 in Dark Sable Finish.

M725-95 — Price: \$2697

MONOGRAM

Gibson End Table

Width: 24 **Depth:** 24 **Height:** 24 **Weight:** 75 / 75 lbs **Cube:** 11.39

Materials: Quartered Ash Solids & Veneers

Highlight Striping: N/A **Contrast Door/Drawer:** N/A **Country:** CHINA

One soft-close drawer, one fixed shelf and a fluted, brushed brass pull. Also available as 6725-95 in Dark Sable Finish.

M740-CH — Price: \$5457

MONOGRAM

Heatherwood Chest

Width: 60 **Depth:** 20 **Height:** 36 **Weight:** 164 / 164 lbs **Cube:** 32.7

Materials: Walnut Solids & Veneers

Highlight Striping: N/A **Contrast Door/Drawer:** N/A **Country:** CHINA

Six soft-close drawers, polished nickel hardware. Also available as 6740-CH-M Modern Truffle Finish, 6740-CH-S Sheer Dove Finish.

M740-ET — Price: \$2997

MONOGRAM

Heatherwood End Table

Width: 34 **Depth:** 20 **Height:** 28 **Weight:** 87 / 87 lbs **Cube:** 15.26

Materials: Walnut Solids & Veneers

Highlight Striping: N/A **Contrast Door/Drawer:** N/A **Country:** CHINA

Three soft-close drawers with polished nickel accents. Also available as 6740-ET-M Modern Truffle Finish, 6740-ET-S Sheer Dove Finish.

M740-17 — Price: \$6687

MONOGRAM

Heatherwood Master Chest

Width: 76 **Depth:** 20 **Height:** 36 **Weight:** 0 / 335 lbs **Cube:** 39.19

Materials: Walnut Solids & Veneers

Highlight Striping: N/A **Contrast Door/Drawer:** N/A **Country:** CHINA

Nine soft-close drawers with polished nickel metal accents. Also available as 6740-17-S Sheer Dove Finish.

M740-38 — Price: \$3777

MONOGRAM

Heatherwood Large End Table

Width: 38 **Depth:** 20 **Height:** 32 **Weight:** 135 / 135 lbs **Cube:** 18.89

Materials: Walnut Solids & Veneers

Highlight Striping: N/A **Contrast Door/Drawer:** N/A **Country:** CHINA

Two soft-close drawers with an electrical outlet and two USB outlets in the top drawer and polished nickel metal accents. Also available as 6740-38 Modern Truffle Finish,

M741-CH — Price: \$5607

MONOGRAM

Miller Chest

Width: 60 **Depth:** 20 **Height:** 36 **Weight:** 224 / 224 lbs **Cube:** 34.81

Materials: Walnut Solids & Veneers

Highlight Striping: N/A **Contrast Door/Drawer:** N/A **Country:** CHINA

Six soft-close drawers with brushed brass hardware and metal accents.

M741-ET — Price: \$3687

MONOGRAM

Miller End Table

Width: 28 **Depth:** 22 **Height:** 28 **Weight:** 102 / 102 lbs **Cube:** 13.69

Materials: Walnut Solids & Veneers

Highlight Striping: N/A **Contrast Door/Drawer:** N/A **Country:** CHINA

Two soft-close drawers with brushed brass hardware and metal accents. Also available as 6741-ET-M Modern Truffle Finish, 6741-ET-S Sheer Dove Finish.

M741-17 — Price: \$6537

MONOGRAM

Miller Master Chest

Width: 76 **Depth:** 20 **Height:** 36 **Weight:** 300 / 300 lbs **Cube:** 49.6

Materials: Walnut Solids & Veneers

Highlight Striping: N/A **Contrast Door/Drawer:** N/A **Country:** CHINA

Nine soft-close drawers and Brushed Brass metal leg posts. Also available as 6741-17-M Modern Truffle Finish, 6741-17-S Sheer Dove Finish.

M741-38 — Price: \$3897

MONOGRAM

Miller Large End Table

Width: 40 **Depth:** 22 **Height:** 32 **Weight:** 138 / 138 lbs **Cube:** 21.52

Materials: Walnut Solids & Veneers

Highlight Striping: N/A **Contrast Door/Drawer:** N/A **Country:** CHINA

One fixed shelf, two soft-close drawers, Brushed Brass metal leg posts. Also available as 6741-38-M Modern Truffle Finish, 6741-38-S Sheer Dove Finish.

M761-96 — Price: \$2397

MONOGRAM

Herbert Console

Width: 50 **Depth:** 12 **Height:** 31 **Weight:** 84 / 84 lbs **Cube:** 10.76

Materials: Walnut Solids and Veneers

Highlight Striping: N/A **Contrast Door/Drawer:** N/A **Country:** CHINA

Also available as 6761-96 in Dark Sable with Soft White interior.

M762-96 — Price: \$3987

MONOGRAM

Lendell Console Table

Width: 64 **Depth:** 16 **Height:** 36 **Weight:** 161 / 161 lbs **Cube:** 27.5

Materials: Quartered Ash Solids & Veneers

Highlight Striping: N/A **Contrast Door/Drawer:** N/A **Country:** CHINA

One fixed shelf and three soft-close drawers wrapped in Glazed Tan linen. Also available as 6762-96 in Dark Sable Finish.

MONOGRAM

M763-17 — Price: \$7197

MONOGRAM

Hillcrest Credenza

Width: 69 **Depth:** 16 **Height:** 36 **Weight:** 197 / 197 lbs **Cube:** 32.23

Materials: Birch Solids & Walnut Veneers

Highlight Striping: N/A **Contrast Door/Drawer:** N/A **Country:** VIETNAM

Features four doors, two soft-close drawers, two adjustable shelves and a cord exit hole behind each set of doors. Polished nickel metal accents. Also available as 6763-17 Sheer Dove Finish.

M763-96 — Price: \$4617

MONOGRAM

Hillcrest Console Table

Width: 46 **Depth:** 16 **Height:** 36 **Weight:** 138 / 138 lbs **Cube:** 21.66

Materials: Birch Solids & Walnut Veneers

Highlight Striping: N/A **Contrast Door/Drawer:** N/A **Country:** VIETNAM

Features two soft-close drawers, two doors, one adjustable shelf and a cord exit hole with polish nickel metal accents. Also available as 6763-96 in Sheer Dove Finish.

M764-81 — Price: \$3447

MONOGRAM

Lionel Console Desk

Width: 56 **Depth:** 20 **Height:** 30 **Weight:** 106 / 106 lbs **Cube:** 10.69

Materials: Birch Solids & Walnut Veneers

Highlight Striping: N/A **Contrast Door/Drawer:** N/A **Country:** CHINA

Antique Brass metal accents and ferrules. Also available as 6764-81 in Dark Sable Finish.

M780-81 — Price: \$4347

MONOGRAM

Patton Desk

Width: 54 **Depth:** 24 **Height:** 30 **Weight:** 148 / 148 lbs **Cube:** 15.61

Materials: Walnut Solids and Veneers

Highlight Striping: N/A **Contrast Door/Drawer:** N/A **Country:** CHINA

One File Drawer and 2 Drawers. Brass Hardware pulls. Also available as 6780-81 in Sheer Dove Finish.

M800-DT — Price: \$6387

MONOGRAM

Lynncliff Dining Table

Width: 84 **Depth:** 42 **Height:** 30 **Weight:** 286 / 286 lbs **Cube:** 50.55

Materials: Quartered Ash Solids & Veneers

Highlight Striping: N/A **Contrast Door/Drawer:** N/A **Country:** CHINA

Finished in Dark Sable, features two 22" removable leaves, and an equalizing slide mechanism. Consists of M800-DT-T and M800DT-B, Lynncliff Dining Table Top and Base. Also available as 6800-DT in Dark Sable Finish.

M801-DT — Price: \$5277

MONOGRAM

Whitby Dining Table

Width: 88 **Depth:** 42 **Height:** 30 **Weight:** 165 / 165 lbs **Cube:** 22.3

Materials: Alder Solids & Walnut Veneers

Highlight Striping: N/A **Contrast Door/Drawer:** N/A **Country:** CHINA

Also available as 6801-DT in Cerused Espresso Finish.

M802-DT — Price: \$5037

MONOGRAM

Bellows Dining Table

Width: 54 **Depth:** 54 **Height:** 30 **Weight:** 164 / 164 lbs **Cube:** 16.79

Materials: Quartered Ash Solids & Veneers

Highlight Striping: N/A **Contrast Door/Drawer:** N/A **Country:** CHINA

Wood Top. Consists of M802-DT-B (Base) and M802-DT-T (Top). Also available as 6802-DT in Sheer Dove Finish.

M803-DT — Price: \$4647

MONOGRAM

Hotchner Round Dining Table

Width: 48 **Depth:** 48 **Height:** 30.5 **Weight:** 217 / 217 lbs **Cube:** 40.66

Materials: Stainless Steel, Acrylic, Walnut Solids and Veneers

Highlight Striping: N/A **Contrast Door/Drawer:** N/A **Country:** CHINA

Features a 22" filler. Also available as 6803-DT Smoked Stone Finish.

M820-17 — Price: \$6597

MONOGRAM

Winston Credenza

Width: 72 **Depth:** 20 **Height:** 38 **Weight:** 252 / 252 lbs **Cube:** 41.62

Materials: Walnut Solids & Veneers

Highlight Striping: N/A **Contrast Door/Drawer:** N/A **Country:** CHINA

Polished Nickel metal accents and one soft-close drawer. Two storage areas feature door openings with adjustable shelves and cord exit holes. Also available as 6820-17 Sheer Dove Finish.

M821-17 — Price: \$7647

MONOGRAM

Baystone Credenza

Width: 80 **Depth:** 20 **Height:** 39 **Weight:** 332 / 332 lbs **Cube:** 48.41

Materials: Alder Solids & Walnut Veneers

Highlight Striping: N/A **Contrast Door/Drawer:** N/A **Country:** CHINA

Polished Nickel hardware and ferrules, five soft-close drawers, storage areas with cord exit holes behind two doors. Also available as 6821-17 in Modern Truffle finish.

M822-17 — Price: \$5397

MONOGRAM

Merritt Credenza

Width: 72 **Depth:** 18 **Height:** 35 **Weight:** 292 / 292 lbs **Cube:** 26.25

Materials: Stainless Steel, Walnut Solids and Veneers

Highlight Striping: N/A **Contrast Door/Drawer:** N/A **Country:** CHINA

Features a Stainless Steel base and accents, Nickel Hardware, Four doors with one shelf behind each door. One center drawer with silver tray liner. Also available as 6822-17 in Smoked Stone finish.

