

FAIRFIELD

Residential Division

MSRP Pricing & Product Specifications

Effective Date: March 11, 2024

*For 24/7 order status and product inventory,
please register on my.furnishweb.com and
select "Fairfield Chair"*

Prices and Specifications Subject to Change Without Notice

Due to the handcrafted nature of our product, dimensions and weights are approximate. Variations in the tailoring, padding and fabric thickness affect the dimensions and weights of each piece and should be expected.

Table of Contents

Ordering Information	3	Cut Yardage	11
Order Entry	3	Pricing Formula (U+ Fabrics)	11
Prices & Specifications		Warranty Information	12-13
Cancellations and Changes	3	COM Information & Order Form	14-15
Shipping and Storage	4	Pricing	
Returns	4	BenchMade Benches	16
Freight Damage and Claims	4	BenchMade Ottomans	19
Routings	4	BenchMade Round Ottomans	21
Options Matrix	5-6	Entree Dining	25
Cushions		Entree Banquettes	64
Cushions - Loose Seat	7	1300 Series Dining Chairs, Bar & Counter Stools	72
Cushions - Tight Seat	7	Haven Reserve	77
Finishes		Urban Living	93
Upholstery and Casgood Custom Finishes	8	Throw Pillows	105
Finishes Recommendation Matrix	9	Color Block Accent Throw Pillows	111
Kickplates	10	Upholstery Product	120
Nailhead Trim Options	10	Casgood Product	332

Ordering Information

- Please send all orders to **orderdept@fairfieldchair.com**
- All orders must be submitted in writing via a P.O. on your Company Purchase Order.
- Please do NOT send orders to your customer relations representative.

The following information must be provided to acknowledge your order.

1. Your purchase order number with billing address
2. Quantity
3. Model Number
4. Description
5. Finish
6. Fabric/Leather Selection: Pattern, Color, and Grade. If C.O.M., please submit a C.O.M. form with your order.
7. Options
8. Pricing (include cost of any options)
9. Indicate any tagging/sidemark or any other special instructions.
10. Shipping destination and any other shipping instructions.
11. Nailhead trim finish and size, unless standard, is desired.
12. When ordering a sectional, recliner, etc., that includes more than (3) pieces or more than (3) fabrics, a sketch or diagram must be included.

Order Entry

All orders are subject to final acceptance by Fairfield Chair Company in Lenoir, NC. No order will be entered for production or acknowledged until all specification information is complete (see above). Fairfield Chair Company attempts to clarify all purchase orders. However, in the event the model number, description, or name on the purchase order differ, the model number will prevail. Acknowledgments will be made for each accepted order and contain the final order specifications on it. The buyer is responsible for checking the acknowledgment to make sure that every detail is correct. If any errors are found, it is the buyer's responsibility to contact our Order Entry Department immediately. Receipt of our acknowledgment indicates acceptance of your order subject to the terms set forth on the acknowledgment. Any duplicate orders not clearly marked "Confirmation" are the responsibility of the buyer.

Prices and Specifications Subject to Change Without Notice

Variations in the tailoring, padding, and fabric thickness affect the dimensions and weights of each piece and should be expected.

Due to the handcrafted nature of our product, variations to plus or minus 1" of our listed measurements could occur.

Specifications are subject to change without notice.

Cancellations & Changes

Because all upholstery items are manufactured to the buyer's specifications, acknowledged orders cannot be canceled for any reason without the written authorization of Fairfield Chair Company.

- No verbal cancellations will be accepted, either from reps or customers.
- All cancellations must be emailed. If a cancellation is approved, it will be subject to a charge of up to 50% of the net price.

Orders for custom merchandise cannot be canceled for any reason (any modification to items included in this price list is considered custom). Fairfield Chair Company is not required to accept any changes to orders. For any accepted and authorized changes, Fairfield Chair Company reserves the right to charge for any expenses incurred due to the change. This includes fabric and other materials, labor, and any other costs, plus up to 25% of the net price. Order changes may also change production and ship date of your order.

Shipping and Storage

Fairfield is a ship as ready manufacturer; orders will be scheduled as ready and ship as pieces are completed. We will ship in accordance with customer instructions whenever possible. Freight will be calculated per shipment at time of invoicing based on applicable rate or minimum charge by ship to zone. Orders in production will be shipped as scheduled and cannot be held. If a customer is unable to accept an order when it is ready for shipment, storage may be requested. Acceptance of a storage request will be at the discretion of Fairfield Chair Company.

All costs including transportation will be at customer's expense. A storage charge of 10% of the invoice will be assessed for every 30 days, or any part thereof, that merchandise remains in storage. Fairfield Chair Company considers transfer to storage the equivalent of delivery. This includes invoicing and payment. Customers will bear all risk of damage or loss during storage.

Returns

If you suspect a manufacturing defect, please contact our Claims department at claims@fairfieldchair.com to request a return authorization form or log into your MY|FurnishWeb account to locate the claims form here: Invoice -> Click Invoice Number -> Service Request. Defective items must be inspected and confirmed by a Fairfield Chair Company representative. If a return is authorized, the item must be received at Fairfield Chair Company accompanied by a signed return authorization and five digital photos of the defect within thirty days of the return authorization issue date. Any damage, signs of use, missing parts, etc. are the sole responsibility of the buyer and will affect the amount of credit issued. Liability for defective merchandise shall be limited to the replacement or repair of that merchandise and Fairfield Chair Company shall not be liable for other damages or losses.

Freight Damage & Claims

Fairfield Chair Company is not liable for any damages to products that occur during transit or storage. The carrier assumes all responsibility upon acceptance of product. It is the buyer's responsibility to inspect products upon receipt and file any claims with the carrier.

- If products are received damaged, a written exception should be made on the bill of lading and an immediate inspection be requested of the carrier.
- Concealed damage must be reported to the carrier within 15 days of receipt.
- Failure to make claims shall constitute acceptance of the products and waiver any claims of defects, errors or shortages.
- Product that is moved from the original delivery address negates this warranty.

"Third Party", "Notify" and "Will Advise" Routings

Orders requesting special routing instructions such as "Third Party", "Notify" or "Will Advise", note the following information:

Important Shipping Information:

Carrier must call (828) 610-2587 or fax (828) 726-8770 at least 24 hours in advance of pickup with acknowledgment number(s) to ensure orders are ready.

Shipping Hours: 7AM - 3PM, Monday - Friday.

Upon pickup, carrier must furnish acknowledgment number(s) to ensure correct orders are released.

Upon notification from Fairfield, we will hold the product for two weeks. If there is no communication within two weeks, Fairfield will ship acknowledgments "collect" with a furniture carrier of our discretion.

Note – Fairfield cartons all upholstery and casegoods items to assist in prevention of freight damage during transit. Our carton/ packaging for upholstered items have been tested by a certified BIMFA testing lab.

Options Matrix

Option	Description	Pillows	Ottomans	Dining Chairs	Chairs	Recliners	Benches Chaises Loveseats Settees	Sofas Queen Sleepers	Extra Long Sofas
Backs (Loose Back)	Any loose back that is not already standard with Blendown, can be substituted for an additional charge.				\$60	\$60	\$120	\$180	\$240
Bullion Fringe (Skirt)	Factory must approve before accepting orders.		\$150		\$225		\$300	\$300	\$300
Banding (Base Trim)	Decorative tape band applied above the welt on platform. Factory must approve before accepting orders.		\$150		\$150		\$225	\$300	\$300
Banding (Decorative Tape Frame)	Decorative tape band frame inset on any loose back pillow.				\$150		\$225	\$300	\$300
Banding (Nails)	Contrast of fabric nail band at base of frame. Factory must approve before accepting order.		\$75		\$105		\$135	\$150	\$150
Banding (Decorative Tape Skirt)	Decorative tape band applied at the bottom of any frame with a skirt.		\$150		\$150		\$225	\$300	\$300
Breathable Denim Panel	For a faster transference of air, loose seat cushions can be upholstered with an optional fabric panel sewn to the bottom of the seat cushion. The fabric panel is made of a denim material which allows for air to transfer through the cushion more efficiently than the vented grommets. This mimics how we upholster leather cushions. Loose seat cushions upholstered this way are non-reversible.				\$36	\$36	\$75	\$105	\$144
Buttons (Contrasting)	Contrast fabric buttons.		\$45	\$45	\$45	\$45	\$45	\$45	\$45
Combination of Fabrics (Inside - Outside)	Combination of fabrics is available on ottomans, chairs, loveseats and sofas. If two Fairfield fabrics are used, the merchandise will be priced at the higher grade price. Contrasting welt is not considered the second fabric.								
Combination of Leathers (Inside - Outside)	Combination of leathers is available on ottomans, chairs, loveseats and sofas. If two Fairfield leathers are used, the merchandise will be priced at the higher grade price. Contrasting welt is not considered the second fabric.								
Combination of Leather & Fabric	Combination of leather and fabric is available on ottomans, chairs, loveseats and sofas. If both Fairfield leather and fabric are used, the merchandise will be priced at the higher grade price.								
Cushions (Loose Seat)	Any loose seat cushion that is not already standard with Blendown, Spring Down, Endurance, or Classic Plush can be substituted for an additional charge.		\$60		\$60	\$60	\$120	\$180	\$240

Options Matrix (continued)

Option	Description	Pillows	Ottomans	Dining Chairs	Chairs	Recliners	Benches Chaises Loveseats Settees	Sofas Queen Sleepers	Extra Long Sofas
Cushion Tie-Downs	Optional cushion tie downs are available on items containing loose seat cushions. Tie-downs are standard on all single bench seat sofa cushions.				\$30		\$60	\$90	\$120
Decorative Cord/Fringe	Decorative welt cords and fringes are available as an optional feature for an additional charge. Cut yardage is also available at a charge of \$24 per yard for cord and fringe. The minimum is 1 yard.	\$36	\$105		\$150	\$150	\$240	\$270	\$270
Glides (Set of 4)	Our standard 5/8" tan nylon glide can be upgraded to any of our optional glides for an additional charge - for options, visit fairfieldchair.com Please Note: <ul style="list-style-type: none"> Clearly specify corresponding glide number when submitting your order. Please consult with the flooring manufacturer for recommendations on the appropriate glides to be used on specific floor coverings. Regular inspection and cleaning of glides is suggested. Replace worn glides to protect your floors. 		\$18	\$18	\$18		\$18	\$18	\$18
Knee-Tilt	Locking mechanism to prevent the chair from rocking. (Gas Lift included).				\$90				
Moisture Barrier Deck (Loose Seat Only)	This beige decking is constructed of a 100% double-knit polyester that has been treated with an oven-dried, multiple step process designed to impart water repellency, stain repellency and anti-microbial properties.				\$36	\$36	\$75	\$90	\$90
Moisture Barrier Seat Only (All Seat Types)	A plain Moisture Barrier liner is designed to protect the foam and cushioning from penetration of liquids. This liner is anti-bacterial, anti-fungal, mildew resistant and meets CAL 117-2013 requirements.		\$75	\$90	\$90	\$90	\$180	\$270	\$270
Throw Pillows (Contrasting)	Contrasting pillows can be ordered where the pillow(s) are a standard feature. Some frames ordered in leather/vinyl will not come standard with pillows.								
	Grade D through U (Fairfield Fabrics)	No Charge							
	Grade U+ (Fairfield Fabrics) and Graded-In Fabrics (D through U).	\$90							
	For graded-in fabrics above Grade U, use the following formula: (# of grades above U) x 5.10 plus \$90, per pillow.								
Welt (Contrasting)	Contrasting welt in (Fairfield Fabrics). For graded-in fabrics above U, please call for pricing.	\$15	\$60	\$75	\$75	\$75	\$90	\$105	\$105
	Contrasting welt cut on Bias.	\$45	\$75	\$90	\$90	\$90	\$150	\$150	\$150
	Contrasting welt in leather.	\$60	\$150	\$180	\$180	\$180	\$285	\$330	\$330

Cushions - Loose Seat



Cushion	Ultra Plush (UP)	Blendown (BD)	Spring Down (SD)	Endurance	Repose	Classic Plush
Standard/Optional	Standard (on select frames)	Standard/ Optional	Optional	Standard/Optional (Contract & Senior Living Frames)	Standard (on Reclination frames)	Standard/ Optional
Firmness	Soft	Medium	Firm	Firm	Soft	Medium
Foam Core Density	2.0	2.0	2.0	2.5	2.0	2.0
Indention Force Detection (IFD)	21	24	22	31	23	26
Foam Caps	Convuluted 1.1 Density	N/A	Marshall Spring with 3" Coils	N/A	N/A	N/A
Fiber Caps	N/A	N/A	3/4 oz. Fiber	3/4 oz. Fiber	3/4 oz. Fiber	2 oz. Fiber
Foam Book Wrap	1.25 oz. Fiber	N/A	N/A	3/4 oz. Fiber	3/4 oz. Fiber	3/4 oz. Fiber
Fiber Down	N/A	N/A	50/50 Fiber Down, 95/5 Feather Down	N/A	N/A	N/A
Ticking	1.25 oz. Kimcloth	Down Proof Ticking	Down Proof Ticking	N/A	Down Proof Ticking	1.25 oz. Kimcloth

Refer to Options on page 5 for additional cushion pricing.

Cushions - Tight Seat

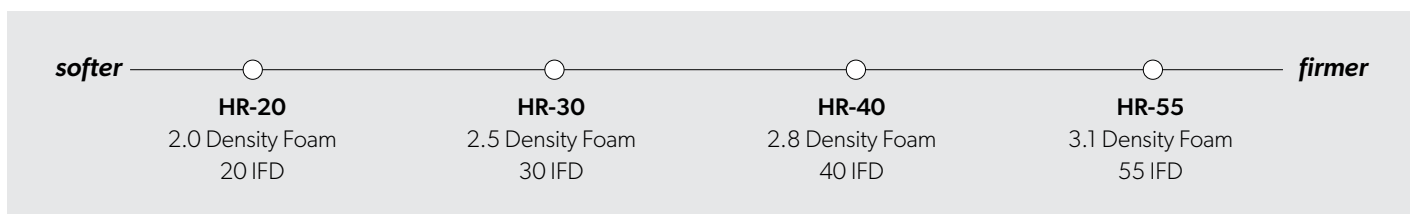

"HR" stands for "High-Resiliency" foam which is used on most tight seats.

Upholstery and Casegood Custom Finishes

All our hand-applied finishes require multiple steps from our skilled American artisans. As a result, each piece will be unique with variations in color, shading, burnishing, distressing, crackle and/or texture. Each piece is treated as a true work of art, one-of-a-kind pieces that are rich in beauty and personality. To preserve this character, we offer FairShield+ as a standard application on all upholstery finishes. This clear, protective topcoat varnish forms a chemically cross-linked barrier that is more resistant to wear and more impervious to moisture & commercial cleaning materials. FairShield+ is also formulated with UV inhibitors to reduce the harmful effects of sunlight and features silver ion technology (an antimicrobial agent) to help preserve the finish and protect against mold, mildew, fungus and odor-causing bacteria. Our Casegood finishes for Monogram have a Conversion Varnish topcoat.

Custom Finishes

Almond Buff	Cerused Espresso	Flint	Linen	Pearl	Tobacco
Antique Pinewood	Charcoal	Graphite	Manhattan	Sable	Toffee
Biscotti	Dark Sable	Graystone	Mica	Sheer Dove	Walnut
Black	English Honey	Hazelnut	Modern Truffle	Smoked Stone	
Café Mocha	Espresso	Light Cherry	Montego Bay	Tahitian Pearl	

Note: A custom match finish is available with a minimum order of 50 items for an additional charge of \$180 per style, per match finish. Please submit a finish sample for review and approval. Contact your customer service representative for more information.

Upholstery Custom Finishes Cleaning Tips

The “silver ion” technology in our FairShield+ finish topcoat means that it deters the growth of bacteria. Clorox wipes can be used to clean and remove soiled areas on the finish surface, using the wipe on, wipe off method. First, wipe on the surface with a Clorox wipe. Then immediately wipe off with a damp cloth. Agents with less than 5% ammonium chloride and agents with sodium chloride or sodium chlorite may also be used to clean the finish surface. After cleaning the finish surface with one of these three agents, we strongly suggest that the finish surface be cleaned with warm, clear water and dried with a soft cloth.

Wood Cleaning & Care

- It is important to ensure that the surface is dried.
- Always wipe in the direction of the wood grain.
- Household polishes that are wax free and silicone free can be used on an infrequent basis (we recommend Guardsman Furniture Polish).
- Routine cleaning will prevent long term damage from dirt and grease which will form a film over time, dulling and discoloring the finish.
- Using anything other than a mild soap solution and then drying the surface with a soft cloth may damage the finish.
- Where possible, keep finish away from exposure to direct sun. Over time sunlight may change the color of the finish, and/or damage the finish.
- Avoid extreme temperature or moisture as they can cause wood to expand or contract leading to potential coating damage.

CREATE YOUR OWN CUSTOM PAINT PROGRAM

Select any wall paint color from Sherwin-Williams (or any other brand). For accurate matching, please provide the paint brand, paint name and paint number. Paint matching (finish code = PM) is not available on upholstery but is offered on 750+ Casegoods styles and all Monogram styles. All Create Your Own styles are sealed with a conversion varnish topcoat finished to a medium sheen.

CUSTOM EMBELLISHMENTS & STRIPING

Custom Embellishments (i.e., choice of contrast doors, drawers or interiors) are offered on Monogram and Create Your Own styles for a 25% upcharge. Striping highlights are available in your choice of Aged Gold, Pewter, Platinum or Gold for a \$450 upcharge. Striping application is at the factory’s discretion, unless otherwise specified.

CONVERSION VARNISH

Ideal for high-use environments, Conversion Varnish resists wear and is more impervious to moisture. You can add Conversion Varnish to stocked, pre-finished Casegoods with a wooden surface (top surface only) for a 15% upcharge or a \$450 minimum charge.

Upholstery and Casegood Custom Finishes *(continued)*

All our hand-applied finishes require multiple steps from our skilled American artisans. As a result, each piece will be unique with variations in color, shading, burnishing, distressing, crackle and/or texture. Each piece is treated as a true work of art, one-of-a-kind pieces that are rich in beauty and personality. To preserve this character, we offer FairShield+ as a standard application on all upholstery finishes. This clear, protective topcoat varnish forms a chemically cross-linked barrier that is more resistant to wear and more impervious to moisture & commercial cleaning materials. FairShield+ is also formulated with UV inhibitors to reduce the harmful effects of sunlight and features silver ion technology (an antimicrobial agent) to help preserve the finish and protect against mold, mildew, fungus and odor-causing bacteria. Our Casegood finishes for Monogram have a Conversion Varnish topcoat.

Finish	Code	Recommended on Ash	Recommended on Rubberwood	Recommended on Maple	Recommended on Beech	Physical Distressing	Chemical Distressing	Sheen
Almond Buff	AL	Y	N	N	N	Medium	Yes	Low
Antique Pinewood	30	Y	Y	Y	Y	Medium	No	Medium
Biscotti	BT	Y	N	N	N	Light	No	Low
Black	95	Y	Y	Y	Y	Light	No	Low
Cafe Mocha	47	Y	Y	Y	Y	Light	No	Low
Cerused Espresso	CE	Y	Y	Y	Y	Light	No	Low
Charcoal	CL	Y	Y	Y	Y	Light	No	Medium
Dark Sable	DS	Y	Y	Y	Y	Light	Yes	Low
English Honey	25	Y	Y	Y	Y	Medium	No	Medium
Espresso	88	Y	Y	Y	Y	Light	No	Medium
Flint	16					Light	No	Low
Graphite	06	Y	Y	Y	Y	Medium	Yes	Low
Graystone	49	Y	Y	Y	Y	Medium	Yes	Low
Hazelnut	HZ	Y	N	Y	Y	Medium	Yes	Medium
Light Cherry	66	Y	Y	Y	Y	Light	No	Medium
Linen	09	Y	Y	Y	Y	Light	No	Low
Manhattan	99	Y	Y	Y	Y	Light	No	High
Mica	86	Y	Y	Y	Y	Light	Yes	Low
Modern Truffle	MT	Y	Y	Y	Y	Light	No	Low
Montego Bay	48	Y	Y	Y	Y	Light	No	Low
Pearl	0E	Y	Y	Y	Y	Light	No	Low
Sable	70	Y	Y	Y	Y	Light	No	Medium
Sheer Dove	SD	Y	Y	Y	Y	Light	No	Low
Smoked Stone	SS	Y	Y	Y	Y	Light	No	Medium
Tahitian Pearl	TP	Y	Y	Y	Y	Light	Yes	Medium
Tobacco	14	Y	Y	Y	Y	Medium	Yes	Low
Toffee	15	Y	Y	Y	Y	Light	Yes	Medium
Walnut	44	Y	Y	Y	Y	Light	No	Medium

Kickplates - Bar and Counter Stools

Kickplate finish for bar and counter stools will be consistent with selected nailhead trim.

- Nickel or pewter nails will have a nickel kickplate.
- Brass nails will have a brushed brass kickplate.
- Aged bronze nails will have an aged bronze kickplate.
- Black Nickel nails will have a black nickel kickplate.

If no nailhead trim is used, the standard kickplate will be brushed brass, unless otherwise specified.

Nailhead Trim Options

When selecting your nailhead trim, please specify the number, size, and color (**example: 1009 Small Pewter**).

If a frame is standard with nails, Brass finish will be applied, unless otherwise specified.

Please see individual items in price list for availability and pricing. Please see the website for color photos of each nail.

SMALL 1/2"	Applied in a fashion that each nailhead touches the previous nailhead.					
Available in the following colors:	1009 Small Brass (Standard)	1009 Small Bright Brass	1009 Small Nickel	1009 Small Pewter	1009 Small Aged Bronze	1009 Small Black Nickel
MEDIUM 5/8"	Applied with consistent finger width spacing between each nail.					
Available in the following colors:	1054 Medium Brass	1054 Medium Bright Brass	1054 Medium Nickel	1054 Medium Pewter	1054 Medium Aged Bronze	1054 Medium Black Nickel

When selecting a combination of small or medium nails you must include the cost of each nail size applied. For instance, if you select a small nail and a medium nail combination, you will need to add the cost of each nail size to the price of the piece.

Cut Yardage

Prices listed below are based on 54-inch wide fabric. A minimum order is one yard. Shipping and handling will be added.

D Grade	\$30
E Grade	\$36
F Grade	\$42
G Grade	\$48
H Grade	\$54
J Grade	\$60
K Grade	\$66
L Grade	\$72
M Grade	\$78
N Grade	\$84
O Grade	\$90

P Grade	\$96
Q Grade	\$102
R Grade	\$108
S Grade	\$114
T Grade	\$120
U Grade	\$126
U+1 Grade	\$132
U+2 Grade	\$138
U+3 Grade	\$144
U+4 Grade	\$150
U+5 Grade	\$156

U+6 Grade	\$162
U+7 Grade	\$168
U+8 Grade	\$174
U+9 Grade	\$180
U+10 Grade	\$186
U+11 Grade	\$192
U+12 Grade	\$198
U+13 Grade	\$204
U+14 Grade	\$210
U+15 Grade	\$216
U+16 Grade	\$222

U+17 Grade	\$228
U+18 Grade	\$234
U+19 Grade	\$240
U+20 Grade	\$246
U+21 Grade	\$252
U+22 Grade	\$258
U+23 Grade	\$264
U+24 Grade	\$270
U+25 Grade	\$276

Pricing Formula (U+ Fabrics)

Each frame lists individual pricing from grades D through U; however, some fabrics may fall beyond U grade. These fabrics are graded using a "U+" format.

Fairfield uses the following formula for "U+" fabrics:
(# of grades above U) × Riser + U Grade = Price

Please Note: Risers, U Grade Pricing and U+ Pricing Formulas are provided for each individual item throughout the price list. See each individual frame for this information.

For example*: If you choose to upholster the 1431-01 Lounge Chair in fabric 4995 Poppy (which currently is a U+8 grade), you will use the following formula:

$$8 \text{ (# of grades above U)} \times \$15 \text{ (Riser)} + \$2,340 \text{ (U Grade price)} = \$2,460$$

1431-01 Lounge Chair in fabric 4995 Poppy (U+8) would be \$2,460*

*This example is for illustrative purposes only.

Fairfield Warranty Information

Upholstery	Residential Coverage*	Commercial Coverage*	Exclusions
Workmanship	One (1) year	One (1) year	Fairfield warrants standard catalog products for one (1) year from the date of invoice to the original agent/dealer against defects in workmanship when put to ordinary use. This warranty does not cover damage or injury caused by unreasonable or abusive use, climatic/environmental conditions, issues caused during installation, freight damage, unauthorized repair, failure to provide necessary or reasonable care, by accident, alteration, tampering or negligence.
Frames	Limited Lifetime	Five (5) years	If these components do not perform as expected under normal conditions, these items will be repaired or replaced at No Charge, once our staff has determined "liability." This service policy extends solely to the original customer under conditions of normal use and service.
Fabrics	Not Warranted	Not Warranted	Fairfield does not guarantee and will not assume responsibility for color fastness or the wearing qualities of any fabric. Any adjustment made will depend on the fabric manufacturer's willingness to stand behind their product. We cannot be responsible for color variations beyond a reasonable commercial match. Fairfield will not be responsible for fabric that has been treated with a stain-repellent finish by the customer. Fairfield will not be responsible for costs associated with repair or replacement of fabrics that deteriorate, delaminate or otherwise fail in the field. Always refer to textile cleaning and care methods provided by the fabric manufacturer. Fairfield does not warrant damage to fabrics caused by improper cleaning and care methods.
Customer's Own Material (COM) or FOM (Graded-In purchased on behalf of the customer)	Not Warranted	Not Warranted	Once a COM or FOM fabric is inspected, measured and accepted, Fairfield assumes no responsibilities for its overall performance, flammability, durability, color fastness, or any other quality issues after upholstery on a Fairfield product. Fairfield will not be held responsible for any tailoring variance that results from the application of a particular fabric to a specific frame. All COM and FOM fabrics must have backing applied or will be rejected for upholstery. Fairfield reserves the right to refuse any material not suitable for upholstery sent in to be used as COM. Fairfield will not be responsible for fabric that has been treated with a stain-repellent finish by the customer. Fairfield will not be responsible for costs associated with repair or replacement of fabrics that deteriorate, delaminate or otherwise fail in the field. Always refer to textile cleaning and care methods provided by the fabric manufacturer. Fairfield does not warrant damage to fabrics caused by improper cleaning and care methods.
Leather	Not Warranted	Not Warranted	The following properties are not covered under this warranty: Colorfastness, Shrinkage, Wrinkling and Stretching. Leather is a natural material, with every hide uniquely enhanced by natural features. Wrinkles, scratches, insect bites, healed scars, naturally occurring color variations, and other natural markings are not flaws. To limit naturally occurring variations, reduce exposure to direct sunlight, extreme temperatures, and washing. Body oils and perspiration can change the color and appearance of leather.
Ultra Plush, Reclination Repose, and Classic Plush Seat Cushions	Limited Lifetime	One (1) year	If these components do not perform as expected under normal conditions, these items will be repaired or replaced at No Charge, once our staff has determined "liability." Cushions can lose 1/2" - 3/4" of loft during the break-in period. This is considered normal and not a defect. This service policy extends solely to the original customer. Regular maintenance, rotating and fluffing is recommended for all cushions.
Blendown and Spring Down Seat Cushions	Limited Lifetime	One (1) year	If these components do not perform as expected under normal conditions, these items will be repaired or replaced at No Charge, once our staff has determined "liability." Cushions can lose 1/2" - 3/4" of loft during the break-in period. This is considered normal and not a defect. Compression of blendown materials and occasional loss of feathers and loss of shape is considered normal. This service policy extends solely to the original customer. Regular maintenance, rotating and fluffing is recommended for all cushions.
Endurance Seat Cushions	Limited Lifetime	Five (5) years	If these components do not perform as expected under normal conditions, these items will be repaired or replaced at No Charge, once our staff has determined "liability." Cushions can lose 1/2" - 3/4" of loft during the break-in period. This is considered normal and not a defect. This service policy extends solely to the original customer.
Back Pillows	Limited Lifetime	Five (5) years	Warranty does not cover normal compression of fillings materials. Fluff all semi-attached back pillows and rotate and fluff all loose back pillows regularly.
Arm Pillows	One (1) year	One (1) year	Warranty does not cover normal compression of fillings materials. Fluff all throw pillows regularly.
Knee-Tilt and Gas Lift Mechanisms	Two (2) years	Two (2) years	Under conditions of normal use and service.
Manual Executive Swivel Bases and Mechanisms	Five (5) years	Five (5) years	Under conditions of normal use and service.
Casters	Five (5) years	Five (5) years	Fairfield's standard caster is suitable for most floors. Our casters function best on a low pile carpet or solid flooring. We cannot control how carpet or flooring will limit the caster's ability to function. Fairfield does not accept liability for damages to a floor that might be created by the use of an improper caster. Always consult the flooring manufacturer for recommendations of caster use.
Glides	Not Warranted	Not Warranted	Fairfield's standard glide is suitable for most floors; however, we offer specialty upcharge glides which may be preferable on certain types of flooring. Fairfield does not accept liability for damages to a floor that might be created by the use of an improper or incorrect glide. Always consult with the flooring manufacturer for their recommended glide.
Reclination Motion Battery Packs	One (1) year	One (1) year	
Reclination Motion Control Switches	One (1) year	One (1) year	
Recliner Mechanisms (non-motorized)	Three (3) years	Three (3) years	Fairfield will replace defective parts of inner mechanisms and pay installation costs up to \$150 for the first (1) year. Within three (3) years inner mechanism will be replaced by Fairfield, but freight and installation costs are not included after the first (1) year. After three (3) years, the inner mechanism may continue to be serviced, but Fairfield reserves the right to charge for repair or replacement of any mechanism.
Recliner Mechanisms (motorized)	Three (3) years	Three (3) years	Fairfield will replace defective parts of inner mechanisms and pay installation costs up to \$150 for the first (1) year. Within three (3) years, a defective inner mechanism will be replaced by Fairfield, but freight and installation costs are not included after the first (1) year. After three (3) years, the inner mechanism may continue to be serviced, but Fairfield reserves the right to charge for repair or replacement of any mechanism.
Swivel and Swivel Glider Mechanisms	Three (3) years	Three (3) years	Under conditions of normal use and service.
Sleeper Mechanisms	Two (2) years	Two (2) years	Under conditions of normal use and service.
Innerspring Sleeper Mattresses	Five (5) years	----	Under conditions of normal use and service.
Renting, recovering, misuse or abuse	Not Warranted	Not Warranted	
Damage due to carrier or customer handling	Not Warranted	Not Warranted	Should damage be discovered after delivery, you are responsible for filing a written concealed damage claim with the carrier, requesting the carrier to make an inspection, and creating a written damage report for the carrier. Freight claims must be communicated within 15 days of receipt of products. Products that are moved from the original delivery address and are not inspected at the time of receipt negate this warranty. Storage or installation of Fairfield products in any facility other than a temperature and humidity controlled environment voids all warranties, expressed or implied.

Fairfield Warranty Information *(continued)*

Casegoods	Residential Coverage*	Commercial Coverage*	Exclusions
Casegood Wood Products	One (1) year	One (1) year	Fairfield warrants standard catalog products for one year from the date of invoice against defects in workmanship when put to ordinary use. This warranty does not cover damage or injury caused by unreasonable or abusive use, climatic/environmental conditions, issues caused during installation, freight damage, unauthorized repair, failure to provide necessary or reasonable care, by accident, alteration, tampering or negligence. Variations in raw materials, wood grain, color, texture, markings and distressing are inherent natural characteristics of wooden furniture. Natural color changes, variations, or movement in lumber or veneer products, and exposure to extreme temperature changes and/or direct sunlight, may cause color and/or surface changes which are not considered defects. Certain casegood products are made with a variety of materials found in nature. These include, but are not limited to, various wood and plant species, stone and minerals, shells and certain animal bi-products. Fairfield warrants these materials free from defects and workmanship for a period of one (1) year from date of invoice to the original agent/dealer. However, certain changes in these materials over time are expected and are not considered defects.
Marble and Stone Tops	120 Days	120 Days	Marble and stone tops are warranted to be free of defects in material and workmanship when put to ordinary use for 120 days from the date of invoice. Variations in raw materials, color, texture, veins and voids are a natural character of this product and are not considered a defect. Due to the absorbent characteristics of genuine marble, Fairfield does not warrant against stains that occur as result of spills. Marble and Stone should be inspected at the time of delivery.
Acrylic, Glass and Mirrors	120 Days	120 Days	Acrylic, Glass and Mirrors are warranted against defects in materials and workmanship when put to ordinary use for 120 days of invoice. Chips and scratches that occur from handling after delivery are not the responsibility of Fairfield. Glass and Mirror products should be inspected at the time of delivery.

General Warranty Statements

The following conditions apply to this warranty except where prohibited by law:

This warranty is valid for the original agent/dealer from the date of invoice and warrants the products to be free of defects in materials and workmanship when put to ordinary use for the length of time specified.

It is always the primary intention of Fairfield to deliver first quality furniture to our customers. Should a manufacturing issue or transit-related damage arise, Fairfield reserves the right to repair or replace the item(s) involved. If a local medic can sufficiently repair and restore the piece(s) to first-quality condition, Fairfield will proceed in that manner. On-site repairs allow the customer to begin utilizing the product sooner and avoid unnecessary costs and time delays involved in a replacement.

Warranty service is handled through the original furniture agent/dealer. Should service be needed, contract your furniture agent/dealer. After receiving Fairfield authorization, the agent/dealer will either repair, replace or return the defective item(s) to the factory for review and disposition. Fairfield's responsibility for transportation cost and labor is limited to one (1) year from the original invoice date and for transportation between the agent/dealer's original shipment location and the factory. If the product has been moved to another location than the original shipment receipt location, Fairfield is not responsible for the transportation cost to return to the original shipment receipt location.

Replacement parts for office mechanisms, office bases, loose seat cushions, back pillow cores, and swivel bases are without charge when covered under this warranty. Installation of these items is the responsibility of the agent/dealer and is not covered by this warranty.

Fabric matching standards will be determined by Fairfield unless specified by the customer. Please note that seams are often required when applying the material in a non-railroaded (directional) application. This application is at the discretion of Fairfield and is not considered a defect in workmanship.

Color variations in finishes - some unavoidable natural variations occur in wood species, both solids and veneers, and are an inherent natural characteristic of wooden furniture. These characteristics are not considered a defect in materials or workmanship and therefore are not a basis for a warranty claim.

Our upholstered frames are constructed to support individuals up to 300 pounds per seat and our Bariatric Chairs are constructed to support individuals up to 500 pounds per seat. Testing results are based on BIFMA standards.

Consequential and incidental damages are excluded from this warranty. This warranty gives you specific legal right, and you may also have other rights that vary from state to state.

Alterations of any type to the product by the customer/agent/dealer will nullify the warranty entirely.

*Coverage of warranty begins at date of invoice.

COM / COL Instructions

(Please Read very carefully.)

To follow is BOTH COM form to submit with PO, and COM Yardage Quote Form.

Submit POs to OrderDept@fairfieldchair.com with completed COM form.

Submit quote requests to YardageQuotes@fairfieldchair.com.

Send COM / COL to:
Fairfield Chair / Attn: COM Dept
606 Kincaid Circle SW
Lenoir NC 28645

COM Form to follow must accompany the fabric. If fabric is sent without the form, it may cause a delay in production.

Include Customer name, customer ack, and SKU to be covered when sending COM / COL.

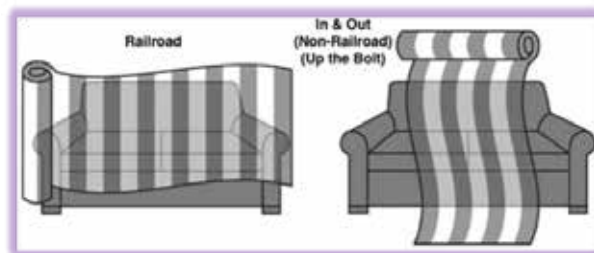
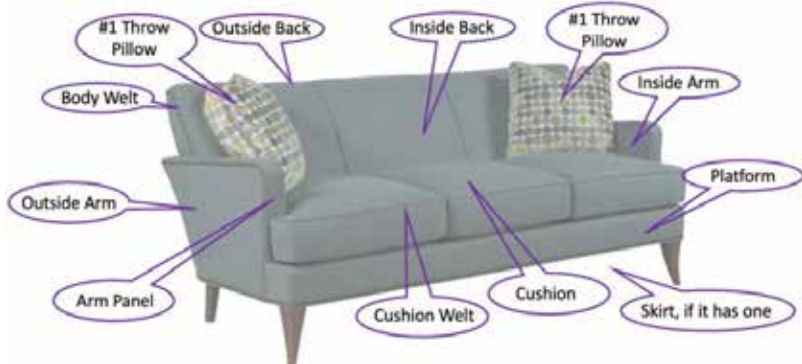

- * All COM must have backing or it will be rejected.
- * Fabrics with more than 40% silk content will not be accepted.
- * All fabrics containing silk or silk-like fabrics must have a knit backing.
- * All fabric must be a quality upholstery material. Fairfield reserves the right to reject any material that does not meet our standards and Fairfield is not responsible for defective COM/COL.
- * Do not assume fabric application is obvious. Send a diagram to be sure.
- * Fabric must be between 52" and 60" wide. Stripes are applied vertically unless otherwise noted
- * Fairfield recommends requesting a yardage quote if covering more than 10 seats or sending multiple COM.

How to calculate yardage if covering up to 10 seats

Based on pattern repeat, add the following percentage to the price list yardage requirement for COM, up to 10 frames:

Fabric Width	Plain to 6"	6" to 14"	15" to 20"	21" to 27"	Over 27"
54"	10%	20%	25%	30%	50%
52" - 53"	25%	35%	40%	45%	60%

- Add Horizontal & Vertical together to get total repeat.
- Fairfield is unable to accept COM/FOM fabrics that are **less** than 52" wide and that are **wider** than 60".

Please do not assume that fabric application is obvious. Attach a sample of your fabric in the space provided, paying careful attention to the top of the pattern and the face side of the fabric. Stripes will be applied vertically, unless otherwise noted. Also, please provide application instructions in the space provided (below).

- California Technical Bulletin 117-2013 is a mandatory flammability standard for component materials used to make upholstered furniture.

COM ONLY FORM

OR

COM WITH YARDAGE QUOTE FORM

COM Form / COM Quote Form *Quote #*
 MUST be emailed with the PO
and included with COM shipment.
 Include tracking number if available.

* Email COM Yardage Quote Request to
yardagequotes@fairfieldchair.com.

* Recommended for repeats and any on 10 or more frames.

Quote #

assigned by Fairfield:

Date: _____ Account #: _____

Dealer name: _____

Contact name: _____ Email: _____

Sales rep: _____ Job / PO#: _____

Frame SKU: _____ Quantity: _____ How many COM fabrics: _____

FABRIC 1

Mill Name / Pattern / Color: _____ Stripe Is: Vertical? or Horizontal?
 Placement (Inback, Outback, Seat Cushion, In Arm, Out Arm, etc.) Tracking #: _____

Fabric Width: _____ Horizontal Repeat: _____ Vertical Repeat: _____ Yards Needed: _____
To be completed by Fairfield

FABRIC 2

Mill Name / Pattern / Color: _____ Stripe Is: Vertical? or Horizontal?
 Placement (Inback, Outback, Seat Cushion, In Arm, Out Arm, etc.) Tracking #: _____

Fabric Width: _____ Horizontal Repeat: _____ Vertical Repeat: _____ Yards Needed: _____
To be completed by Fairfield

FABRIC 3

Mill Name / Pattern / Color: _____ Stripe Is: Vertical? or Horizontal?
 Placement (Inback, Outback, Seat Cushion, In Arm, Out Arm, etc.) Tracking #: _____

Fabric Width: _____ Horizontal Repeat: _____ Vertical Repeat: _____ Yards Needed: _____
To be completed by Fairfield

Special application instructions (i.e. special motifs to center on cushions)

If no instructions are given, then application will be up to factory discretion.

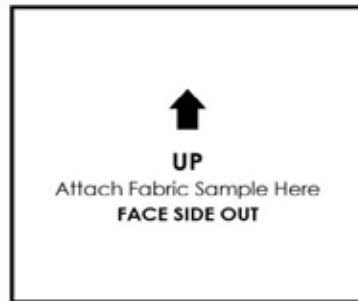
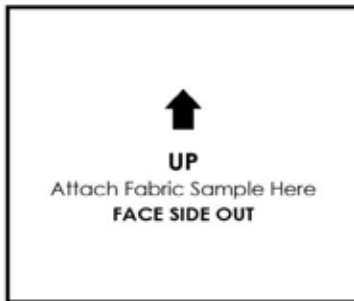
INSERT PHOTOS OF YOUR FABRICS

Note: Fairfield is unable to accept COM/FOM fabrics that are **less** than 52" wide or **wider** than 60"
 If more than 3 fabrics are requested on a SKU, Fairfield requires a tearsheet to shows the location of each fabric.

To have excess yardage returned to you, please include either FedEx or UPS account #

UPS # _____ **FedEx #** _____

* California Technical Bulletin 117-2013 is a mandatory flammability standard for component materials used to make upholstered furniture.

BENCHMADE

Benches

Our Benchmade custom bench program offers stylish and fashionable personalized products. Choose from a selection of Benches with choices in upholstery treatments, decorative nailhead details and base options.

1300+ Fairfield Fabrics (plus COM)

6 style options

2 seat options

6 base options

step 1: select your style and seat option

Open Back | Optional small size nailhead trim is available around base and arm panels.



31LX-10
Open Back - Loose Seat
overall w55 d24 h25 in. (with base)



31TX-10
Open Back - Tight Seat
overall w55 d24 h25 in. (with base)

Tuxedo Back | Optional small size nailhead trim is available around base, arm border and back border.



32LX-10
Tuxedo Back - Loose Seat
overall w55 d24 h25 in. (with base)



32TX-10
Tuxedo Back - Tight Seat
overall w55 d24 h25 in. (with base)

Greek Key Arm | Optional small size nailhead trim is available around base and arm panels.



33LX-10
Greek Key Arm - Loose Seat
overall w58.5 d24 h26 in. (with base)



33TX-10
Greek Key Arm - Tight Seat
overall w58.5 d24 h26 in. (with base)

step 2: select a base option

30+ wood finish options available for upholstery

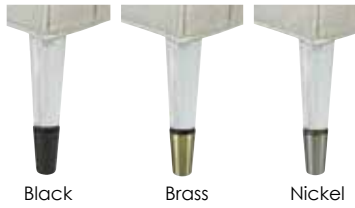

Black

Brass

Nickel

XXXA-XX
Acrylic Leg
leg h8 in.

Select Black, Brass or Nickel finish for metal ferrules



XXXF-XX
Framed Base
base h8 in.



XXXH-XX
Stretcher Base
base h8 in.



Brushed Brass

Brushed Nickel

XXXM-XX
Metal Leg
leg h8 in.

Select Brushed Brass or Brushed Nickel finish for metal leg



XXXS-XX
Skirted Base
Only available in fabric.



XXXW-XX
Wooden Leg
leg h8 in.

Style Build Example:

33 T M - 10
Style Seat Base Bench
Greek Key Tight Seat Metal Leg



*If selected, please specify an acrylic leg metal ferrule finish, metal leg finish or small nailhead finish on order.

FAIRFIELD®

fairfieldchair.com   

Benchmade Benches

Style Number		31L(X)-10	31T(X)-10	32L(X)-10	32T(X)-10	33L(X)-10	33T(X)-10
Leather Number							
Name		Open Back with Loose Seat Bench	Open Back with Tight Seat Bench	Tuxedo Back with Loose Bench	Tuxedo Back with Tight Seat Bench	Greek Key Arm with Loose Bench	Greek Key Arm with Tight Seat Bench
Collection		Benchmade Benches	Benchmade Benches	Benchmade Benches	Benchmade Benches	Benchmade Benches	Benchmade Benches
Overall Dimensions	Width	55	55	55	55	58.5	58.5
	Depth	24	24	24	24	24	24
	Height	25	25	25	25	26	26
Arm Height		25	25	25	25	26	26
Seat Height		19	19	19	19	19	19
Seat Depth		24	24	17	17	17	17
Inside Width		46	46	46	46	46	46
Standard Throw Pillow(s)		N/A	N/A	N/A	N/A	N/A	N/A
Wrap , Carton Weight, Cubes		53 , 73 , 26.76	56 , 76 , 23.16	74 , 74 , 19.09	70 , 70 , 19.09	74 , 94 , 29.96	74 , 74 , 21.12
Grade D		\$2,175	\$1,875	\$2,325	\$2,325	\$2,430	\$2,250
Grade E		\$2,196	\$1,893	\$2,349	\$2,346	\$2,454	\$2,271
Grade F		\$2,217	\$1,911	\$2,373	\$2,367	\$2,478	\$2,292
Grade G		\$2,238	\$1,929	\$2,397	\$2,388	\$2,502	\$2,313
Grade H		\$2,259	\$1,947	\$2,421	\$2,409	\$2,526	\$2,334
Grade J		\$2,280	\$1,965	\$2,445	\$2,430	\$2,550	\$2,355
Grade K (COM)		\$2,301	\$1,983	\$2,469	\$2,451	\$2,574	\$2,376
Grade L		\$2,322	\$2,001	\$2,493	\$2,472	\$2,598	\$2,397
Grade M (COL)		\$2,343	\$2,019	\$2,517	\$2,493	\$2,622	\$2,418
Grade N		\$2,364	\$2,037	\$2,541	\$2,514	\$2,646	\$2,439
Grade O		\$2,385	\$2,055	\$2,565	\$2,535	\$2,670	\$2,460
Grade P		\$2,406	\$2,073	\$2,589	\$2,556	\$2,694	\$2,481
Grade Q		\$2,427	\$2,091	\$2,613	\$2,577	\$2,718	\$2,502
Grade R		\$2,448	\$2,109	\$2,637	\$2,598	\$2,742	\$2,523
Grade S		\$2,469	\$2,127	\$2,661	\$2,619	\$2,766	\$2,544
Grade T		\$2,490	\$2,145	\$2,685	\$2,640	\$2,790	\$2,565
Grade U		\$2,511	\$2,163	\$2,709	\$2,661	\$2,814	\$2,586
U+ Formula (See pg.12)		(# above U) x 21 + 2511	(# above U) x 18 + 2163	(# above U) x 24 + 2709	(# above U) x 21 + 2661	(# above U) x 24 + 2814	(# above U) x 21 + 2586
Riser		21	18	24	21	24	21
COM (Yards)		7.50	6.00	8.25	7.25	9.25	7.50
COL (sq. ft.)		N/A	N/A	N/A	N/A	N/A	N/A
Leather 1		N/A	N/A	N/A	N/A	N/A	N/A
Leather 2		N/A	N/A	N/A	N/A	N/A	N/A
Leather 3		N/A	N/A	N/A	N/A	N/A	N/A
Leather 4		N/A	N/A	N/A	N/A	N/A	N/A
Leather 5		N/A	N/A	N/A	N/A	N/A	N/A
Leather 6		N/A	N/A	N/A	N/A	N/A	N/A
Leather 8		N/A	N/A	N/A	N/A	N/A	N/A
Standard Seat Cushion		Endurance	High Resiliency 40	Endurance	High Resiliency 40	Endurance	High Resiliency 40
Finish Options		Y	Y	Y	Y	N	Y
Nail-head Trim	Small	135	150	150	150	90	90
	Medium	N/A	N/A	N/A	N/A	N/A	N/A

BENCHMADE

Ottomans

Our Benchmade custom ottoman program offers stylish and fashionable personalized products. Choose from a selection of Square Ottomans, Benches and Cocktail Ottomans with choices in upholstery treatments, decorative nail details and base options.

1400+ Fairfield Fabrics and Leathers (plus COM)

3 style options | **3** top options | **4** base options | **10** size options

step 1: select your shape and size

HXXX-XX Rectangular Bench



HPSS-52

CXXX-XX Cocktail Ottoman



CBDW-42

OXXX-XX Square Ottoman



OPDA-22

- 48 w48 d20 h19 in.
- 52 w52 d20 h19 in.
- 60 w60 d20 h19 in.

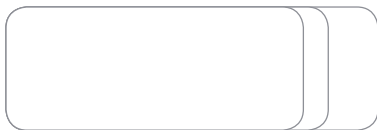

- 42 w42 d30 h19 in.
- 52 w52 d38 h19 in.

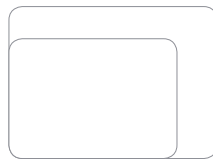

- 22 w22 d22 h19 in.
- 36 w36 d36 h19 in.
- 42 w42 d42 h19 in.
- 48 w48 d48 h19 in.
- 52 w52 d52 h19 in.

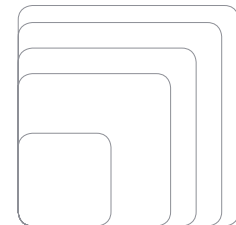

step 2: select a top



XPXX-XX
Plain Top



XBXX-XX
Biscuit Tufted Top



XCXX-XX
Channel Quilted Top

step 3: select a small size nailhead trim option available in all finishes and around base border.

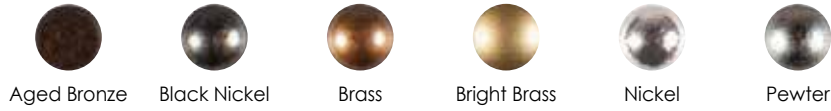

XXSX-XX
Standard- No Nails



XXGX-XX
Greek Key



XXDX-XX
Double Border



XXXX-XX
X-Border

step 4: select a base

30+ wood finish options available for upholstery



XXXA-XX
Acrylic Leg

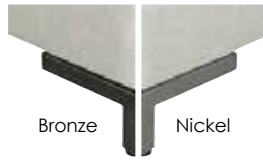

XXXM-XX
Metal Leg
Select Bronze or Nickel
finish for metal leg



XXXS-XX
Skirted Leg
Only available in fabric



XXXW-XX
Wooden Leg

Style Build Example:

H	C	G	M	—	60
Shape Rectangular Bench	Top Channel Quilted Top	Nail Greek Key	Base Metal Leg		Size Bench Size



*If selected, please specify metal leg finish or small nailhead finish on order.

FAIRFIELD®

fairfieldchair.com

BENCHMADE

Round Ottomans

Our Benchmade round ottoman program offers stylish and fashionable personalized products. Choose from a selection of round ottomans with choices in upholstery treatments, decorative nail details and base options.

1400+ Fairfield Fabrics and Leathers (plus COM)

4 top options | 4 nail options | 5 base options

step 1: select a 36.5" round top



RPXX-XX
Plain Top



RMXX-XX
Mitered Top



RQXX-XX
Quilted Top



RTXX-XX
Tufted Top

step 2: select a small size nailhead trim option

available in all finishes and around base border (not available on skirted base).



Aged Bronze



Black Nickel



Brass



Bright Brass



Nickel



Pewter



RXSX-XX
Standard- No Nails



RXNX-XX
Single Row



RXDX-XX
Double Border



RXXX-XX
X-Border

step 3: select a base

30+ wood finish options available for upholstery

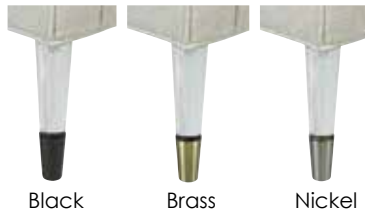

Black Brass Nickel

RXXA-XX
Acrylic Leg

leg h8 in. | overall w36.5 d36.5 h19.25 in.
Select Black, Brass or Nickel finish for metal ferrules



RXXF-XX
Framed Base

base h14 in.
overall w36.5 d36.5 h19.25 in.
Six wooden legs, available with **(N)** single row nailhead trim only

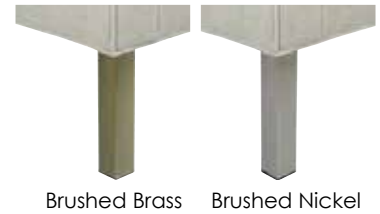

Brushed Brass Brushed Nickel

RXXM-XX
Metal Leg

leg h8 in. | overall w36.5 d36.5 h19.25 in.
Select Brushed Brass or Brushed Nickel finish for metal leg



RXXS-XX
Skirted Base

skirt height 8 in.
overall w36.5 d36.5 h19.25 in.
Standard with casters,
nailhead trim not available,
only available in fabric.



RXXW-XX
Wooden Leg

leg h8 in.
overall w36.5 d36.5 h19.25 in.

Style Build Example:

R T D A — 36
Round Top Nails Base Ottoman
Hand Tufted Double Border Acrylic Leg Size
(Brass Ferrule)



*If selected, please specify an acrylic leg metal ferrule finish, metal leg finish or small nailhead finish on order.

FAIRFIELD®

fairfieldchair.com   

Benchmade Ottomans

Style Number		C(XXX)-42	C(XXX)-52	H(XXX)-48	H(XXX)-52	H(XXX)-60	O(XXX)-22
Leather Number		L-C(XXX)-42	L-C(XXX)-52	L-H(XXX)-48	L-H(XXX)-52	L-H(XXX)-60	L-O(XXX)-22
Name		Cocktail Ottoman	Cocktail Ottoman	Rectangular Ottoman	Rectangular Ottoman	Rectangular Ottoman	Square Ottoman
Collection		Benchmade Ottomans	Benchmade Ottomans	Benchmade Ottomans	Benchmade Ottomans	Benchmade Ottomans	Benchmade Ottomans
Overall Dimensions	Width	42	52	48	52	60	22
	Depth	30	38	20	20	20	22
	Height	19	19	19	19	19	19
Arm Height		N/A	N/A	N/A	N/A	N/A	N/A
Seat Height		N/A	N/A	N/A	N/A	N/A	N/A
Seat Depth		N/A	N/A	N/A	N/A	N/A	N/A
Inside Width		N/A	N/A	N/A	N/A	N/A	N/A
Standard Throw Pillow(s)		N/A	N/A	N/A	N/A	N/A	N/A
Wrap, Carton Weight, Cubes		50, 50, 13.85	55, 55, 21.72	35, 35, 10.55	40, 40, 11.43	45, 45, 13.19	35, 35, 5.32
Grade D		\$1,485	\$1,701	\$1,386	\$1,452	\$1,536	\$1,056
Grade E		\$1,500	\$1,716	\$1,398	\$1,464	\$1,548	\$1,065
Grade F		\$1,515	\$1,731	\$1,410	\$1,476	\$1,560	\$1,074
Grade G		\$1,530	\$1,746	\$1,422	\$1,488	\$1,572	\$1,083
Grade H		\$1,545	\$1,761	\$1,434	\$1,500	\$1,584	\$1,092
Grade J		\$1,560	\$1,776	\$1,446	\$1,512	\$1,596	\$1,101
Grade K (COM)		\$1,575	\$1,791	\$1,458	\$1,524	\$1,608	\$1,110
Grade L		\$1,590	\$1,806	\$1,470	\$1,536	\$1,620	\$1,119
Grade M (COL)		\$1,605	\$1,821	\$1,482	\$1,548	\$1,632	\$1,128
Grade N		\$1,620	\$1,836	\$1,494	\$1,560	\$1,644	\$1,137
Grade O		\$1,635	\$1,851	\$1,506	\$1,572	\$1,656	\$1,146
Grade P		\$1,650	\$1,866	\$1,518	\$1,584	\$1,668	\$1,155
Grade Q		\$1,665	\$1,881	\$1,530	\$1,596	\$1,680	\$1,164
Grade R		\$1,680	\$1,896	\$1,542	\$1,608	\$1,692	\$1,173
Grade S		\$1,695	\$1,911	\$1,554	\$1,620	\$1,704	\$1,182
Grade T		\$1,710	\$1,926	\$1,566	\$1,632	\$1,716	\$1,191
Grade U		\$1,725	\$1,941	\$1,578	\$1,644	\$1,728	\$1,200
U+ Formula (See pg.12)		(# above U) × 15 + 1725	(# above U) × 15 + 1941	(# above U) × 12 + 1578	(# above U) × 12 + 1644	(# above U) × 12 + 1728	(# above U) × 9 + 1200
Riser		15	15	12	12	12	9
COM (Yards)		4.50	4.50	3.75	4.00	4.25	2.75
COL (sq. ft.)		68	85	57	62	74	40
Leather 1		\$2,250	\$2,625	\$2,175	\$2,250	\$2,325	\$1,485
Leather 2		\$2,355	\$2,760	\$2,265	\$2,355	\$2,445	\$1,545
Leather 3		\$2,460	\$2,895	\$2,355	\$2,460	\$2,565	\$1,605
Leather 4		\$2,565	\$3,030	\$2,445	\$2,565	\$2,685	\$1,665
Leather 5		\$2,670	\$3,165	\$2,535	\$2,670	\$2,805	\$1,725
Leather 6		\$2,775	\$3,300	\$2,625	\$2,775	\$2,925	\$1,785
Leather 8		\$3,720	\$4,470	\$3,420	\$3,630	\$3,945	\$2,340
Standard Seat Cushion		High Resiliency 40	High Resiliency 40	High Resiliency 40	High Resiliency 40	High Resiliency 40	High Resiliency 40
Finish Options		N	N	N	N	N	N
Nail-head Trim*	Small	Std.	Std.	Std.	Std.	Std.	Std.
	Medium	N/A	N/A	N/A	N/A	N/A	N/A

*Nailhead Trim is not included on the base border of the Skirted Base option

Benchmade Ottomans

Style Number		O(XXX)-36	O(XXX)-42	O(XXX)-48	O(XXX)-52	R(XXX)-36
Leather Number		L-O(XXX)-36	L-O(XXX)-42	L-O(XXX)-48	L-O(XXX)-52	L-R(XXX)-36
Name		Square Ottoman	Square Ottoman	Square Ottoman	Square Ottoman	Round Ottoman
Collection		Benchmade Ottomans	Benchmade Ottomans	Benchmade Ottomans	Benchmade Ottomans	Benchmade Round Ottomans
Overall Dimensions	Width	36	42	48	52	36.5
	Depth	36	42	48	52	36.5
	Height	19	19	19	19	19.25
Arm Height		N/A	N/A	N/A	N/A	N/A
Seat Height		N/A	N/A	N/A	N/A	N/A
Seat Depth		N/A	N/A	N/A	N/A	N/A
Inside Width		N/A	N/A	N/A	N/A	N/A
Standard Throw Pillow(s)		N/A	N/A	N/A	N/A	N/A
Wrap, Carton Weight, Cubes		50 , 50 , 14.25	60 , 60 , 19.39	65 , 65 , 25.33	70 , 70 , 29.73	32 , 32 , 14.84
Grade D		\$1,452	\$1,569	\$1,815	\$1,980	\$2,145
Grade E		\$1,467	\$1,584	\$1,830	\$1,998	\$2,163
Grade F		\$1,482	\$1,599	\$1,845	\$2,016	\$2,181
Grade G		\$1,497	\$1,614	\$1,860	\$2,034	\$2,199
Grade H		\$1,512	\$1,629	\$1,875	\$2,052	\$2,217
Grade J		\$1,527	\$1,644	\$1,890	\$2,070	\$2,235
Grade K (COM)		\$1,542	\$1,659	\$1,905	\$2,088	\$2,253
Grade L		\$1,557	\$1,674	\$1,920	\$2,106	\$2,271
Grade M (COL)		\$1,572	\$1,689	\$1,935	\$2,124	\$2,289
Grade N		\$1,587	\$1,704	\$1,950	\$2,142	\$2,307
Grade O		\$1,602	\$1,719	\$1,965	\$2,160	\$2,325
Grade P		\$1,617	\$1,734	\$1,980	\$2,178	\$2,343
Grade Q		\$1,632	\$1,749	\$1,995	\$2,196	\$2,361
Grade R		\$1,647	\$1,764	\$2,010	\$2,214	\$2,379
Grade S		\$1,662	\$1,779	\$2,025	\$2,232	\$2,397
Grade T		\$1,677	\$1,794	\$2,040	\$2,250	\$2,415
Grade U		\$1,692	\$1,809	\$2,055	\$2,268	\$2,433
U+ Formula (See pg.12)		(# above U) × 15 + 1692	(# above U) × 15 + 1809	(# above U) × 15 + 2055	(# above U) × 18 + 2268	(# above U) × 18 + 2433
Riser		15	15	15	18	18
COM (Yards)		4.75	5.00	5.25	5.25	6.00
COL (sq. ft.)		79	85	90	102	85
Leather 1		\$2,400	\$2,550	\$2,775	\$2,985	\$2,850
Leather 2		\$2,520	\$2,685	\$2,910	\$3,150	\$2,985
Leather 3		\$2,640	\$2,820	\$3,045	\$3,315	\$3,120
Leather 4		\$2,760	\$2,955	\$3,180	\$3,480	\$3,255
Leather 5		\$2,880	\$3,090	\$3,315	\$3,645	\$3,390
Leather 6		\$3,000	\$3,225	\$3,450	\$3,810	\$3,525
Leather 8		\$4,095	\$4,395	\$4,695	\$5,220	\$4,695
Standard Seat Cushion		High Resiliency 40	High Resiliency 40	High Resiliency 40	High Resiliency 40	High Resiliency 40
Finish Options		N	N	N	N	N
Nail-head Trim*	Small	Std.	Std.	Std.	Std.	Std.
	Medium	N/A	N/A	N/A	N/A	N/A

*Nailhead Trim is not included on the base border of the Skirted Base option

ENTRÉE DINING



5 back shape choices

2 back tailoring options

2 back heights

2 base options

3 stocked wood finish options

40+ custom wood finish options

	Finish Options	Stocked Finish: Linen	Stocked Finish: Mica	Stocked Finish: Tobacco
Fabric Styles	XXXX-05	XXXX-05-L	XXXX-05-M	XXXX-05-T
Leather Styles	L-XXXX-05	L-XXXX-05-L	L-XXXX-05-M	L-XXXX-05-T

Concave Back with Legs

- Available in fabric or leather (L- prefix).
- Choose from 40+ wood finish options or three stocked finishes.
- Optional small nailhead trim available on base.

		Plain Back		Button Back	
Concave Back w19.5 d27 h36.5 in.	Concave Tall Back w19.5 d27 h40.5 in.	1200-05 1200-05-L 1200-05-M 1200-05-T	1204-05 1204-05-L 1204-05-M 1204-05-T	1202-05 1202-05-L 1202-05-M 1202-05-T	1206-05 1206-05-L 1206-05-M 1206-05-T

Concave Back with Skirt

- Available in fabric only.
- Legs are standard in Tobacco finish.

Concave Back Skirted w19.5 d27 h36.5 in.	Concave Tall Back Skirted w19.5 d27 h40.5 in.	1201-05-T	1205-05-T	1203-05-T	1207-05-T

Camel Back with Legs

- Available in fabric or leather (L- prefix).
- Choose from 40+ wood finish options or three stocked finishes.
- Optional small nailhead trim available on base.

Camel Back w19.5 d27 h37.5 in.	Camel Tall Back w19.5 d27 h41.5 in.	1220-05 1220-05-L 1220-05-M 1220-05-T	1224-05 1224-05-L 1224-05-M 1224-05-T	1222-05 1222-05-L 1222-05-M 1222-05-T	1226-05 1226-05-L 1226-05-M 1226-05-T

Camel Back with Skirt

- Available in fabric only.
- Legs are standard in Tobacco finish.

Camel Back Skirted w19.5 d27 h37.5 in.	Camel Tall Back Skirted w19.5 d27 h41.5 in.	1221-05-T	1225-05-T	1223-05-T	1227-05-T

FAIRFIELD®

fairfieldchair.com

Plain Back

Button Back

Straight Back **with Legs**

- Available in fabric or leather (L- prefix).
- Choose from 40+ wood finish options or three stocked finishes.
- Optional small nailhead trim available on base.



Straight Back
w19.5 d27 **h36.5 in.**



Straight Tall Back
w19.5 d27 **h40.5 in.**



1210-05 →
1210-05-L
1210-05-M
1210-05-T



1214-05 →
1214-05-L
1214-05-M
1214-05-T



1212-05 →
1212-05-L
1212-05-M
1212-05-T



1216-05 →
1216-05-L
1216-05-M
1216-05-T

Straight Back **with Skirt**

- Available in fabric only.
- Legs are standard in Tobacco finish.



Straight Back Skirted
w19.5 d27 **h36.5 in.**



Straight Tall Back Skirted
w19.5 d27 **h40.5 in.**



1211-05-T



1215-05-T



1213-05-T



1217-05-T

Empire Back **with Legs**

- Available in fabric or leather (L- prefix).
- Choose from 40+ wood finish options or three stocked finishes.
- Standard with small nailhead trim on inback and base.



Empire Back
w19.5 d27 **h38 in.**



Empire Tall Back
w19.5 d27 **h42 in.**



1240-05 →
1240-05-L
1240-05-M
1240-05-T



1244-05 →
1244-05-L
1244-05-M
1244-05-T



1242-05 →
1242-05-L
1242-05-M
1242-05-T



1246-05 →
1246-05-L
1246-05-M
1246-05-T

Empire Back **with Skirt**

- Available in fabric only.
- Legs are standard in Tobacco finish.
- Standard with small nailhead trim on inback.



Empire Back Skirted
w19.5 d27 **h38 in.**



Empire Tall Back Skirted
w19.5 d27 **h42 in.**



1241-05-T



1245-05-T



1243-05-T



1247-05-T

Pull Back **with Legs**

- Available in fabric or leather (L- prefix).
- Choose from 40+ wood finish options or three stocked finishes for legs and wooden pull.
- Optional small nailhead trim available on base.



Pull Back
w19.5 d27 **h36.5 in.**



Pull Tall Back
w19.5 d27 **h40.5 in.**



1230-05 →
1230-05-L
1230-05-M
1230-05-T



1234-05 →
1234-05-L
1234-05-M
1234-05-T



1232-05 →
1232-05-L
1232-05-M
1232-05-T



1236-05 →
1236-05-L
1236-05-M
1236-05-T

Pull Back **with Skirt**

- Available in fabric.
- Wooden pull available in 40+ wood finish options or three stocked finishes.
- Legs are standard in Tobacco finish.



Pull Back Skirted
w19.5 d27 **h36.5 in.**



Pull Tall Back Skirted
w19.5 d27 **h40.5 in.**



1231-05 →
1231-05-L
1231-05-M
1231-05-T



1235-05 →
1235-05-L
1235-05-M
1235-05-T



1233-05 →
1233-05-L
1233-05-M
1233-05-T



1237-05 →
1237-05-L
1237-05-M
1237-05-T

ENTRÉE DINING

Armless Stack Chairs



5 back shape choices

2 back tailoring options

2 back heights

3 stocked wood finish options

40+ custom wood finish options

	Finish Options	Stocked Finish: Linen	Stocked Finish: Mica	Stocked Finish: Tobacco
Fabric Styles	XXXX-14	XXXX-14-L	XXXX-14-M	XXXX-14-T
Leather Styles	L-XXXX-14	L-XXXX-14-L	L-XXXX-14-M	L-XXXX-14-T

Plain Back

Button Back

Concave Back

- Available in fabric or leather (L-prefix).
- Choose from 40+ wood finish options or three stocked finishes.
- Optional small nailhead trim available on base.



Concave Short Back
w19.5 d27 **h36.5 in.**



Concave Tall Back
w19.5 d27 **h40.5 in.**



1200-14
1200-14-L
1200-14-M
1200-14-T



1204-14
1204-14-L
1204-14-M
1204-14-T



1202-14
1202-14-L
1202-14-M
1202-14-T



1206-14
1206-14-L
1206-14-M
1206-14-T

Camel Back

- Available in fabric or leather (L- prefix).
- Choose from 40+ wood finish options or three stocked finishes.
- Optional small nailhead trim available on base.



Camel Short Back
w19.5 d27 **h37.5 in.**



Camel Tall Back
w19.5 d27 **h41.5 in.**



1220-14
1220-14-L
1220-14-M
1220-14-T



1224-14
1224-14-L
1224-14-M
1224-14-T



1222-14
1222-14-L
1222-14-M
1222-14-T



1226-14
1226-14-L
1226-14-M
1226-14-T

Straight Back

- Available in fabric or leather (L- prefix).
- Choose from 40+ wood finish options or three stocked finishes.
- Optional small nailhead trim available on base.



Straight Short Back
w19.5 d27 **h36.5 in.**



Straight Tall Back
w19.5 d27 **h40.5 in.**



1210-14
1210-14-L
1210-14-M
1210-14-T



1214-14
1214-14-L
1214-14-M
1214-14-T



1212-14
1212-14-L
1212-14-M
1212-14-T



1216-14
1216-14-L
1216-14-M
1216-14-T

Note: Stacking more than three chairs high is not recommended.

FAIRFIELD®

Upholstery Wood Finish Options

Empire Back

- Available in fabric or leather (L- prefix).
- Choose from 40+ wood finish options or three stocked finishes.
- Standard with small nailhead trim on inback and base.

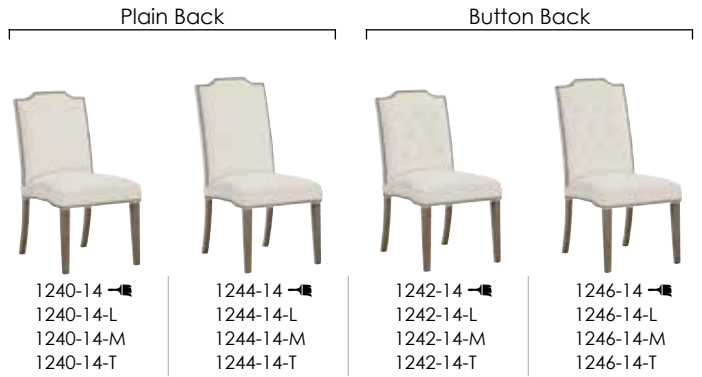

Pull Back

- Available in fabric or leather (L- prefix).
- Choose from 40+ wood finish options or three stocked finishes for legs and wooden pull.
- Optional small nailhead trim available on base.



📷 Shown: 1210-14-M Straight Short Back Armless Stack Chair

Note: Stacking more than three chairs high is not recommended.

FAIRFIELD®

fairfieldchair.com

Stocked Finish Codes

Linen (-L) Mica (-M) Sheer Dove (-S) Tobacco (-T)

Collection		Entrée Dining		Entrée Dining		Entrée Dining	
Name		Concave Short Back Dining Chair with Legs, Finish Choices		Concave Short Back Dining Chair with Legs in Stocked Finishes		Concave Short Back Armless Stack Chair with Legs, Finish Choices	
SKU Options		Fabric Style	Leather Style	Fabric Style	Leather Style	Fabric Style	Leather Style
		1200-05	L-1200-05	1200-05-L	L-1200-05-L	1200-14	L-1200-14
				1200-05-M	L-1200-05-M		
				1200-05-S	L-1200-05-S		
				1200-05-T	L-1200-05-T		
Overall Dimensions	Width	19.5		19.5		19.5	
	Depth	27		27		27	
	Height	37		37		36.5	
Seat Height		20		20		20	
Seat Depth		19		19		19	
Inside Width		19.5		19.5		19.5	
Wrap, Carton Weight, Cubes		22, 22, 11.27		22, 22, 11.27		22, 22, 11.12	
		Fabric	Leather	Fabric	Leather	Fabric	Leather
Grade D / Leather 1		\$1,077	\$1,737	\$897	\$1,557	\$1,077	\$1,737
Grade E / Leather 2		\$1,086	\$1,827	\$906	\$1,647	\$1,086	\$1,827
Grade F / Leather 3		\$1,095	\$1,917	\$915	\$1,737	\$1,095	\$1,917
Grade G / Leather 4		\$1,104	\$2,007	\$924	\$1,827	\$1,104	\$2,007
Grade H / Leather 5		\$1,113	\$2,097	\$933	\$1,917	\$1,113	\$2,097
Grade J / Leather 6		\$1,122	\$2,187	\$942	\$2,007	\$1,122	\$2,187
Grade K (COM)		\$1,131		\$951		\$1,131	
Grade L / Leather 8		\$1,140	\$2,982	\$960	\$2,802	\$1,140	\$2,982
Grade M (COL)		\$1,149		\$969		\$1,149	
Grade N		\$1,158		\$978		\$1,158	
Grade O		\$1,167		\$987		\$1,167	
Grade P		\$1,176		\$996		\$1,176	
Grade Q		\$1,185		\$1,005		\$1,185	
Grade R		\$1,194		\$1,014		\$1,194	
Grade S		\$1,203		\$1,023		\$1,203	
Grade T		\$1,212		\$1,032		\$1,212	
Grade U		\$1,221		\$1,041		\$1,221	
U+ Formula (See pg.12)		(# above U) x 9 + 1221		(# above U) x 9 + 1041		(# above U) x 9 + 1221	
Riser		9		9		9	
COM (Yards)		2.75		2.75		2.75	
COL (sq. ft.)			57		57		57
Standard Seat Cushion		High Resiliency 40		High Resiliency 40		High Resiliency 40	
Finish Options		Y		N		Y	
Nail-head Trim	Small	45	45	45	45	45	45
	Medium	N/A	N/A	N/A	N/A	N/A	N/A

Stocked Finish Codes

Linen (-L)

Mica (-M)

Sheer Dove (-S)

Tobacco (-T)

Collection		Entrée Dining		Entrée Dining		Entrée Dining	
Name		Concave Short Back Armless Stack Chair with Legs in Stocked Finishes		Concave Short Back Skirted Dining Chair with Legs in Tobacco Finish		Concave Short Back Dining Chair with Legs, Finish Choices with buttons	
SKU Options		Fabric Style	Leather Style	No Casters		Fabric Style	Leather Style
		1200-14-L	L-1200-14-L	1201-05-T		1202-05	L-1202-05
		1200-14-M	L-1200-14-M				
		1200-14-T	L-1200-14-T				
Overall Dimensions	Width	19.5		19.5		19.5	
	Depth	27		27		27	
	Height	36.5		37		37	
Seat Height		20		20		20	
Seat Depth		19		19		19	
Inside Width		19.5		19.5		19.5	
Wrap, Carton Weight, Cubes		22, 22, 11.12		22, 22, 11.27		22, 22, 15.74	
		Fabric	Leather	Fabric	Fabric	Leather	
Grade D / Leather 1		\$897	\$1,557	\$1,047	\$1,107	\$1,767	
Grade E / Leather 2		\$906	\$1,647	\$1,059	\$1,116	\$1,857	
Grade F / Leather 3		\$915	\$1,737	\$1,071	\$1,125	\$1,947	
Grade G / Leather 4		\$924	\$1,827	\$1,083	\$1,134	\$2,037	
Grade H / Leather 5		\$933	\$1,917	\$1,095	\$1,143	\$2,127	
Grade J / Leather 6		\$942	\$2,007	\$1,107	\$1,152	\$2,217	
Grade K (COM)		\$951		\$1,119	\$1,161		
Grade L / Leather 8		\$960	\$2,802	\$1,131	\$1,170	\$3,012	
Grade M (COL)		\$969		\$1,143	\$1,179		
Grade N		\$978		\$1,155	\$1,188		
Grade O		\$987		\$1,167	\$1,197		
Grade P		\$996		\$1,179	\$1,206		
Grade Q		\$1,005		\$1,191	\$1,215		
Grade R		\$1,014		\$1,203	\$1,224		
Grade S		\$1,023		\$1,215	\$1,233		
Grade T		\$1,032		\$1,227	\$1,242		
Grade U		\$1,041		\$1,239	\$1,251		
U+ Formula (See pg.12)		(# above U) x 9 + 1041		(# above U) x 12 + 1239	(# above U) x 9 + 1251		
Riser		9		12		9	
COM (Yards)		2.75		4.00		2.75	
COL (sq. ft.)				N/A		57	
Standard Seat Cushion		High Resiliency 40		High Resiliency 40		High Resiliency 40	
Finish Options		N		N		Y	
Nail-head Trim	Small	45	45	N/A	45	45	
	Medium	N/A	N/A	N/A	N/A	N/A	

Stocked Finish Codes

Linen (-L) Mica (-M) Sheer Dove (-S) Tobacco (-T)

Collection		Entrée Dining		Entrée Dining		Entrée Dining	
Name		Concave Short Back Dining Chair		Concave Short Back Armless Stack Chair		Concave Short Back Armless Stack Chair	
SKU Options		with Legs in Stocked Finishes with buttons		with Legs, Finish Choices with buttons		with Legs in Stocked Finishes with buttons	
		Fabric Style	Leather Style	Fabric Style	Leather Style	Fabric Style	Leather Style
		1202-05-L	L-1202-05-L	1202-14	L-1202-14	1202-14-L	L-1202-14-L
		1202-05-M	L-1202-05-M			1202-14-M	L-1202-14-M
		1202-05-S	L-1202-05-S			1202-14-T	L-1202-14-T
		1202-05-T	L-1202-05-T				
Overall Dimensions	Width	19.5		19.5		19.5	
	Depth	27		27		27	
	Height	37		36.5		36.5	
Seat Height		20		20		20	
Seat Depth		19		19		19	
Inside Width		19.5		19.5		19.5	
Wrap, Carton Weight, Cubes		22 , 22 , 11.27		22 , 22 , 11.12		22 , 22 , 11.12	
		Fabric	Leather	Fabric	Leather	Fabric	Leather
Grade D / Leather 1		\$927	\$1,587	\$1,107	\$1,767	\$927	\$1,587
Grade E / Leather 2		\$936	\$1,677	\$1,116	\$1,857	\$936	\$1,677
Grade F / Leather 3		\$945	\$1,767	\$1,125	\$1,947	\$945	\$1,767
Grade G / Leather 4		\$954	\$1,857	\$1,134	\$2,037	\$954	\$1,857
Grade H / Leather 5		\$963	\$1,947	\$1,143	\$2,127	\$963	\$1,947
Grade J / Leather 6		\$972	\$2,037	\$1,152	\$2,217	\$972	\$2,037
Grade K (COM)		\$981		\$1,161		\$981	
Grade L / Leather 8		\$990	\$2,832	\$1,170	\$3,012	\$990	\$2,832
Grade M (COL)		\$999		\$1,179		\$999	
Grade N		\$1,008		\$1,188		\$1,008	
Grade O		\$1,017		\$1,197		\$1,017	
Grade P		\$1,026		\$1,206		\$1,026	
Grade Q		\$1,035		\$1,215		\$1,035	
Grade R		\$1,044		\$1,224		\$1,044	
Grade S		\$1,053		\$1,233		\$1,053	
Grade T		\$1,062		\$1,242		\$1,062	
Grade U		\$1,071		\$1,251		\$1,071	
U+ Formula (See pg.12)		(# above U) x 9 + 1071		(# above U) x 9 + 1251		(# above U) x 9 + 1071	
Riser		9		9		9	
COM (Yards)		2.75		2.75		2.75	
COL (sq. ft.)			57		57		57
Standard Seat Cushion		High Resiliency 40		High Resiliency 40		High Resiliency 40	
Finish Options		N		Y		N	
Nail-head Trim	Small	45	45	45	45	45	45
	Medium	N/A	N/A	N/A	N/A	N/A	N/A

Stocked Finish Codes

Linen (-L) Mica (-M) Sheer Dove (-S) Tobacco (-T)

Collection		Entrée Dining	Entrée Dining		Entrée Dining	
Name		Concave Short Back Skirted Dining Chair with Legs in Tobacco Finish with buttons	Concave Tall Back Dining Chair with Legs, Finish Choices		Concave Tall Back Dining Chair with Legs in Stocked Finishes	
SKU Options		No Casters 1203-05-T	Fabric Style 1204-05	Leather Style L-1204-05	Fabric Style 1204-05-L 1204-05-M 1204-05-S 1204-05-T	Leather Style L-1204-05-L L-1204-05-M L-1204-05-S L-1204-05-T
Overall Dimensions	Width	19.5	19.5		19.5	
	Depth	27	27		27	
	Height	37	41		41	
Seat Height		20	20		20	
Seat Depth		19	19		19	
Inside Width		19.5	19.5		19.5	
Wrap, Carton Weight, Cubes		22 , 22 , 11.27	22 , 22 , 12.49		22 , 22 , 12.49	
		Fabric	Fabric	Leather	Fabric	Leather
Grade D / Leather 1		\$1,077	\$1,077	\$1,737	\$897	\$1,557
Grade E / Leather 2		\$1,089	\$1,086	\$1,827	\$906	\$1,647
Grade F / Leather 3		\$1,101	\$1,095	\$1,917	\$915	\$1,737
Grade G / Leather 4		\$1,113	\$1,104	\$2,007	\$924	\$1,827
Grade H / Leather 5		\$1,125	\$1,113	\$2,097	\$933	\$1,917
Grade J / Leather 6		\$1,137	\$1,122	\$2,187	\$942	\$2,007
Grade K (COM)		\$1,149	\$1,131		\$951	
Grade L / Leather 8		\$1,161	\$1,140	\$2,982	\$960	\$2,802
Grade M (COL)		\$1,173	\$1,149		\$969	
Grade N		\$1,185	\$1,158		\$978	
Grade O		\$1,197	\$1,167		\$987	
Grade P		\$1,209	\$1,176		\$996	
Grade Q		\$1,221	\$1,185		\$1,005	
Grade R		\$1,233	\$1,194		\$1,014	
Grade S		\$1,245	\$1,203		\$1,023	
Grade T		\$1,257	\$1,212		\$1,032	
Grade U		\$1,269	\$1,221		\$1,041	
U+ Formula (See pg.12)		(# above U) x 12 + 1269	(# above U) x 9 + 1221		(# above U) x 9 + 1041	
Riser		12	9		9	
COM (Yards)		4.00	2.75		2.75	
COL (sq. ft.)		N/A		57		57
Standard Seat Cushion		High Resiliency 40		High Resiliency 40		
Finish Options		N		Y		
Nail-head Trim	Small	N/A	45	45	45	45
	Medium	N/A	N/A	N/A	N/A	N/A

Stocked Finish Codes

Linen (-L) Mica (-M) Sheer Dove (-S) Tobacco (-T)

Collection		Entrée Dining		Entrée Dining		Entrée Dining	
Name		Concave Tall Back Armless Stack Chair with Legs, Finish Choices		Concave Tall Back Armless Stack Chair with Legs in Stocked Finishes		Concave Tall Back Skirted Dining Chair with Legs in Tobacco Finish	
SKU Options		Fabric Style	Leather Style	Fabric Style	Leather Style	No Casters	
		1204-14	L-1204-14	1204-14-L	L-1204-14-L	1205-05-T	
				1204-14-M	L-1204-14-M		
				1204-14-T	L-1204-14-T		
Overall Dimensions	Width	19.5		19.5		19.5	
	Depth	27		27		27	
	Height	40.5		40.5		41	
Seat Height		20		20		20	
Seat Depth		19		19		19	
Inside Width		19.5		19.5		19.5	
Wrap, Carton Weight, Cubes		22 , 22 , 12.33		22 , 22 , 12.33		22 , 22 , 12.49	
		Fabric	Leather	Fabric	Leather	Fabric	
Grade D / Leather 1		\$1,077	\$1,737	\$897	\$1,557	\$1,047	
Grade E / Leather 2		\$1,086	\$1,827	\$906	\$1,647	\$1,059	
Grade F / Leather 3		\$1,095	\$1,917	\$915	\$1,737	\$1,071	
Grade G / Leather 4		\$1,104	\$2,007	\$924	\$1,827	\$1,083	
Grade H / Leather 5		\$1,113	\$2,097	\$933	\$1,917	\$1,095	
Grade J / Leather 6		\$1,122	\$2,187	\$942	\$2,007	\$1,107	
Grade K (COM)		\$1,131		\$951		\$1,119	
Grade L / Leather 8		\$1,140	\$2,982	\$960	\$2,802	\$1,131	
Grade M (COL)		\$1,149		\$969		\$1,143	
Grade N		\$1,158		\$978		\$1,155	
Grade O		\$1,167		\$987		\$1,167	
Grade P		\$1,176		\$996		\$1,179	
Grade Q		\$1,185		\$1,005		\$1,191	
Grade R		\$1,194		\$1,014		\$1,203	
Grade S		\$1,203		\$1,023		\$1,215	
Grade T		\$1,212		\$1,032		\$1,227	
Grade U		\$1,221		\$1,041		\$1,239	
U+ Formula (See pg.12)		(# above U) x 9 + 1221		(# above U) x 9 + 1041		(# above U) x 12 + 1239	
Riser		9		9		12	
COM (Yards)		2.75		2.75		4.00	
COL (sq. ft.)		57		57		N/A	
Standard Seat Cushion		High Resiliency 40		High Resiliency 40		High Resiliency 40	
Finish Options		Y		N		N	
Nail-head Trim	Small	45	45	45	45	N/A	
	Medium	N/A	N/A	N/A	N/A	N/A	

Stocked Finish Codes

Linen (-L)

Mica (-M)

Sheer Dove (-S)

Tobacco (-T)

Collection		Entrée Dining		Entrée Dining		Entrée Dining	
Name		Concave Tall Back Dining Chair with Legs, Finish Choices with buttons		Concave Tall Back Dining Chair with Legs in Stocked Finishes with buttons		Concave Tall Back Armless Stack Chair with Legs, Finish Choices with buttons	
SKU Options		Fabric Style	Leather Style	Fabric Style	Leather Style	Fabric Style	Leather Style
		1206-05	L-1206-05	1206-05-L 1206-05-M 1206-05-S 1206-05-T	L-1206-05-L L-1206-05-M L-1206-05-S L-1206-05-T	1206-14	L-1206-14
Overall Dimensions	Width	19.5		19.5		19.5	
	Depth	27		27		27	
	Height	41		41		40.5	
Seat Height		20		20		20	
Seat Depth		19		19		19	
Inside Width		19.5		19.5		19.5	
Wrap, Carton Weight, Cubes		22 , 22 , 12.49		22 , 22 , 12.49		22 , 22 , 12.33	
		Fabric	Leather	Fabric	Leather	Fabric	Leather
Grade D / Leather 1		\$1,107	\$1,767	\$927	\$1,587	\$1,107	\$1,767
Grade E / Leather 2		\$1,116	\$1,857	\$936	\$1,677	\$1,116	\$1,857
Grade F / Leather 3		\$1,125	\$1,947	\$945	\$1,767	\$1,125	\$1,947
Grade G / Leather 4		\$1,134	\$2,037	\$954	\$1,857	\$1,134	\$2,037
Grade H / Leather 5		\$1,143	\$2,127	\$963	\$1,947	\$1,143	\$2,127
Grade J / Leather 6		\$1,152	\$2,217	\$972	\$2,037	\$1,152	\$2,217
Grade K (COM)		\$1,161		\$981		\$1,161	
Grade L / Leather 8		\$1,170	\$3,012	\$990	\$2,832	\$1,170	\$3,012
Grade M (COL)		\$1,179		\$999		\$1,179	
Grade N		\$1,188		\$1,008		\$1,188	
Grade O		\$1,197		\$1,017		\$1,197	
Grade P		\$1,206		\$1,026		\$1,206	
Grade Q		\$1,215		\$1,035		\$1,215	
Grade R		\$1,224		\$1,044		\$1,224	
Grade S		\$1,233		\$1,053		\$1,233	
Grade T		\$1,242		\$1,062		\$1,242	
Grade U		\$1,251		\$1,071		\$1,251	
U+ Formula (See pg.12)		(# above U) x 9 + 1251		(# above U) x 9 + 1071		(# above U) x 9 + 1251	
Riser		9		9		9	
COM (Yards)		2.75		2.75		2.75	
COL (sq. ft.)			57		57		57
Standard Seat Cushion		High Resiliency 40		High Resiliency 40		High Resiliency 40	
Finish Options		Y		N		Y	
Nail-head Trim	Small	45	45	45	45	45	45
	Medium	N/A	N/A	N/A	N/A	N/A	N/A

Stocked Finish Codes

Linen (-L) Mica (-M) Sheer Dove (-S) Tobacco (-T)

Collection		Entrée Dining		Entrée Dining		Entrée Dining	
Name		Concave Tall Back Armless Stack Chair with Legs in Stocked Finishes with buttons		Concave Tall Back Skirted Dining Chair with Legs in Tobacco Finish with buttons		Straight Short Back Dining Chair with Legs, Finish Choices	
SKU Options		Fabric Style	Leather Style	No Casters		Fabric Style	Leather Style
		1206-14-L	L-1206-14-L	1207-05-T		1210-05	L-1210-05
		1206-14-M	L-1206-14-M				
		1206-14-T	L-1206-14-T				
Overall Dimensions	Width	19.5		19.5		19.5	
	Depth	27		27		27	
	Height	40.5		41		37	
Seat Height		20		20		20	
Seat Depth		19		19		19	
Inside Width		19.5		19.5		19.5	
Wrap, Carton Weight, Cubes		22, 22, 12.33		22, 22, 12.49		22, 33, 15.74	
		Fabric	Leather	Fabric	Fabric	Leather	
Grade D / Leather 1		\$927	\$1,587	\$1,077	\$1,077	\$1,737	
Grade E / Leather 2		\$936	\$1,677	\$1,089	\$1,086	\$1,827	
Grade F / Leather 3		\$945	\$1,767	\$1,101	\$1,095	\$1,917	
Grade G / Leather 4		\$954	\$1,857	\$1,113	\$1,104	\$2,007	
Grade H / Leather 5		\$963	\$1,947	\$1,125	\$1,113	\$2,097	
Grade J / Leather 6		\$972	\$2,037	\$1,137	\$1,122	\$2,187	
Grade K (COM)		\$981		\$1,149	\$1,131		
Grade L / Leather 8		\$990	\$2,832	\$1,161	\$1,140	\$2,982	
Grade M (COL)		\$999		\$1,173	\$1,149		
Grade N		\$1,008		\$1,185	\$1,158		
Grade O		\$1,017		\$1,197	\$1,167		
Grade P		\$1,026		\$1,209	\$1,176		
Grade Q		\$1,035		\$1,221	\$1,185		
Grade R		\$1,044		\$1,233	\$1,194		
Grade S		\$1,053		\$1,245	\$1,203		
Grade T		\$1,062		\$1,257	\$1,212		
Grade U		\$1,071		\$1,269	\$1,221		
U+ Formula (See pg.12)		(# above U) x 9 + 1071		(# above U) x 12 + 1269	(# above U) x 9 + 1221		
Riser		9		12		9	
COM (Yards)		2.75		4.00		2.75	
COL (sq. ft.)		57		N/A		57	
Standard Seat Cushion		High Resiliency 40		High Resiliency 40		High Resiliency 40	
Finish Options		N		N		Y	
Nail-head Trim	Small	45	45	N/A	45	45	
	Medium	N/A	N/A	N/A	N/A	N/A	

Stocked Finish Codes

Linen (-L) Mica (-M) Sheer Dove (-S) Tobacco (-T)

Collection		Entrée Dining		Entrée Dining		Entrée Dining	
Name		Straight Short Back Dining Chair with Legs in Stocked Finishes		Straight Short Back Armless Stack Chair with Legs, Finish Choices		Straight Short Back Armless Stack Chair with Legs in Stocked Finishes	
SKU Options		Fabric Style	Leather Style	Fabric Style	Leather Style	Fabric Style	Leather Style
		1210-05-L	L-1210-05-L	1210-14	L-1210-14	1210-14-L	L-1210-14-L
		1210-05-M	L-1210-05-M			1210-14-M	L-1210-14-M
		1210-05-S	L-1210-05-S			1210-14-T	L-1210-14-T
		1210-05-T	L-1210-05-T				
Overall Dimensions	Width	19.5		19.5		19.5	
	Depth	27		27		27	
	Height	37		36.5		36.5	
Seat Height		20		20		20	
Seat Depth		19		19		19	
Inside Width		19.5		19.5		19.5	
Wrap, Carton Weight, Cubes		22, 22, 11.27		22, 22, 11.12		22, 22, 11.12	
		Fabric	Leather	Fabric	Leather	Fabric	Leather
Grade D / Leather 1		\$897	\$1,557	\$1,077	\$1,737	\$897	\$1,557
Grade E / Leather 2		\$906	\$1,647	\$1,086	\$1,827	\$906	\$1,647
Grade F / Leather 3		\$915	\$1,737	\$1,095	\$1,917	\$915	\$1,737
Grade G / Leather 4		\$924	\$1,827	\$1,104	\$2,007	\$924	\$1,827
Grade H / Leather 5		\$933	\$1,917	\$1,113	\$2,097	\$933	\$1,917
Grade J / Leather 6		\$942	\$2,007	\$1,122	\$2,187	\$942	\$2,007
Grade K (COM)		\$951		\$1,131		\$951	
Grade L / Leather 8		\$960	\$2,802	\$1,140	\$2,982	\$960	\$2,802
Grade M (COL)		\$969		\$1,149		\$969	
Grade N		\$978		\$1,158		\$978	
Grade O		\$987		\$1,167		\$987	
Grade P		\$996		\$1,176		\$996	
Grade Q		\$1,005		\$1,185		\$1,005	
Grade R		\$1,014		\$1,194		\$1,014	
Grade S		\$1,023		\$1,203		\$1,023	
Grade T		\$1,032		\$1,212		\$1,032	
Grade U		\$1,041		\$1,221		\$1,041	
U+ Formula (See pg.12)		(# above U) x 9 + 1041		(# above U) x 9 + 1221		(# above U) x 9 + 1041	
Riser		9		9		9	
COM (Yards)		2.75		2.75		2.75	
COL (sq. ft.)			57		57		57
Standard Seat Cushion		High Resiliency 40		High Resiliency 40		High Resiliency 40	
Finish Options		N		Y		N	
Nail-head Trim	Small	45	45	45	45	45	45
	Medium	N/A	N/A	N/A	N/A	N/A	N/A

Stocked Finish Codes

Linen (-L) Mica (-M) Sheer Dove (-S) Tobacco (-T)

Collection		Entrée Dining	Entrée Dining		Entrée Dining	
Name		Straight Short Back Skirted Dining Chair with Legs in Tobacco Finish	Straight Short Back Dining Chair with Legs, Finish Choices with buttons		Straight Short Back Dining Chair with Legs in Stocked Finishes with buttons	
SKU Options		No Casters 1211-05-T	Fabric Style 1212-05	Leather Style L-1212-05	Fabric Style 1212-05-L 1212-05-M 1212-05-S 1212-05-T	Leather Style L-1212-05-L L-1212-05-M L-1212-05-S L-1212-05-T
Overall Dimensions	Width	19.5	19.5		19.5	
	Depth	27	27		27	
	Height	37	37		37	
	Seat Height	20	20		20	
	Seat Depth	19	19		19	
	Inside Width	19.5	19.5		19.5	
Wrap, Carton Weight, Cubes		22 , 22 , 11.27	22 , 22 , 11.27		22 , 22 , 11.27	
		Fabric	Fabric	Leather	Fabric	Leather
Grade D / Leather 1		\$1,047	\$1,107	\$1,767	\$927	\$1,587
Grade E / Leather 2		\$1,059	\$1,116	\$1,857	\$936	\$1,677
Grade F / Leather 3		\$1,071	\$1,125	\$1,947	\$945	\$1,767
Grade G / Leather 4		\$1,083	\$1,134	\$2,037	\$954	\$1,857
Grade H / Leather 5		\$1,095	\$1,143	\$2,127	\$963	\$1,947
Grade J / Leather 6		\$1,107	\$1,152	\$2,217	\$972	\$2,037
Grade K (COM)		\$1,119	\$1,161		\$981	
Grade L / Leather 8		\$1,131	\$1,170	\$3,012	\$990	\$2,832
Grade M (COL)		\$1,143	\$1,179		\$999	
Grade N		\$1,155	\$1,188		\$1,008	
Grade O		\$1,167	\$1,197		\$1,017	
Grade P		\$1,179	\$1,206		\$1,026	
Grade Q		\$1,191	\$1,215		\$1,035	
Grade R		\$1,203	\$1,224		\$1,044	
Grade S		\$1,215	\$1,233		\$1,053	
Grade T		\$1,227	\$1,242		\$1,062	
Grade U		\$1,239	\$1,251		\$1,071	
U+ Formula (See pg.12)		(# above U) x 12 + 1239	(# above U) x 9 + 1251		(# above U) x 9 + 1071	
Riser		12	9		9	
COM (Yards)		4.00	2.75		2.75	
COL (sq. ft.)		N/A		57		57
Standard Seat Cushion		High Resiliency 40	High Resiliency 40		High Resiliency 40	
Finish Options		N	Y		N	
Nail-head Trim	Small	N/A	45	45	45	45
	Medium	N/A	N/A	N/A	N/A	N/A

Stocked Finish Codes

Linen (-L) Mica (-M) Sheer Dove (-S) Tobacco (-T)

Collection		Entrée Dining		Entrée Dining		Entrée Dining	
Name		Straight Short Back Armless Stack Chair with Legs, Finish Choices with buttons		Straight Short Back Armless Stack Chair with Legs in Stocked Finishes with buttons		Straight Short Back Skirted Dining Chair with Legs in Tobacco Finish with buttons	
SKU Options		Fabric Style	Leather Style	Fabric Style	Leather Style	No Casters	
		1212-14	L-1212-14	1212-14-L	L-1212-14-L	1213-05-T	
				1212-14-M	L-1212-14-M		
				1212-14-T	L-1212-14-T		
Overall Dimensions	Width	19.5		19.5		19.5	
	Depth	27		27		27	
	Height	36.5		36.5		37	
Seat Height		20		20		20	
Seat Depth		19		19		19	
Inside Width		19.5		19.5		19.5	
Wrap, Carton Weight, Cubes		22 , 22 , 11.12		22 , 22 , 11.12		22 , 22 , 11.27	
		Fabric	Leather	Fabric	Leather	Fabric	
Grade D / Leather 1		\$1,107	\$1,767	\$927	\$1,587	\$1,077	
Grade E / Leather 2		\$1,116	\$1,857	\$936	\$1,677	\$1,089	
Grade F / Leather 3		\$1,125	\$1,947	\$945	\$1,767	\$1,101	
Grade G / Leather 4		\$1,134	\$2,037	\$954	\$1,857	\$1,113	
Grade H / Leather 5		\$1,143	\$2,127	\$963	\$1,947	\$1,125	
Grade J / Leather 6		\$1,152	\$2,217	\$972	\$2,037	\$1,137	
Grade K (COM)		\$1,161		\$981		\$1,149	
Grade L / Leather 8		\$1,170	\$3,012	\$990	\$2,832	\$1,161	
Grade M (COL)		\$1,179		\$999		\$1,173	
Grade N		\$1,188		\$1,008		\$1,185	
Grade O		\$1,197		\$1,017		\$1,197	
Grade P		\$1,206		\$1,026		\$1,209	
Grade Q		\$1,215		\$1,035		\$1,221	
Grade R		\$1,224		\$1,044		\$1,233	
Grade S		\$1,233		\$1,053		\$1,245	
Grade T		\$1,242		\$1,062		\$1,257	
Grade U		\$1,251		\$1,071		\$1,269	
U+ Formula (See pg.12)		(# above U) x 9 + 1251		(# above U) x 9 + 1071		(# above U) x 12 + 1269	
Riser		9		9		12	
COM (Yards)		2.75		2.75		4.00	
COL (sq. ft.)		57		57		N/A	
Standard Seat Cushion		High Resiliency 40		High Resiliency 40		High Resiliency 40	
Finish Options		Y		N		N	
Nail-head Trim	Small	45	45	45	45	N/A	
	Medium	N/A	N/A	N/A	N/A	N/A	

Stocked Finish Codes

Linen (-L) Mica (-M) Sheer Dove (-S) Tobacco (-T)

Collection		Entrée Dining		Entrée Dining		Entrée Dining	
Name		Straight Tall Back Dining Chair with Legs, Finish Choices		Straight Tall Back Dining Chair with Legs in Stocked Finishes		Straight Tall Back Armless Stack Chair with Legs, Finish Choices	
SKU Options		Fabric Style	Leather Style	Fabric Style	Leather Style	Fabric Style	Leather Style
		1214-05	L-1214-05	1214-05-L	L-1214-05-L	1214-14	L-1214-14
				1214-05-M	L-1214-05-M		
				1214-05-S	L-1214-05-S		
				1214-05-T	L-1214-05-T		
Overall Dimensions	Width	19.5		19.5		19.5	
	Depth	27		27		27	
	Height	41		41		40.5	
Seat Height		20		20		20	
Seat Depth		19		19		19	
Inside Width		19.5		19.5		19.5	
Wrap, Carton Weight, Cubes		22 , 22 , 12.49		22 , 22 , 12.49		22 , 22 , 12.33	
		Fabric	Leather	Fabric	Leather	Fabric	Leather
Grade D / Leather 1		\$1,077	\$1,737	\$897	\$1,557	\$1,077	\$1,737
Grade E / Leather 2		\$1,086	\$1,827	\$906	\$1,647	\$1,086	\$1,827
Grade F / Leather 3		\$1,095	\$1,917	\$915	\$1,737	\$1,095	\$1,917
Grade G / Leather 4		\$1,104	\$2,007	\$924	\$1,827	\$1,104	\$2,007
Grade H / Leather 5		\$1,113	\$2,097	\$933	\$1,917	\$1,113	\$2,097
Grade J / Leather 6		\$1,122	\$2,187	\$942	\$2,007	\$1,122	\$2,187
Grade K (COM)		\$1,131		\$951		\$1,131	
Grade L / Leather 8		\$1,140	\$2,982	\$960	\$2,802	\$1,140	\$2,982
Grade M (COL)		\$1,149		\$969		\$1,149	
Grade N		\$1,158		\$978		\$1,158	
Grade O		\$1,167		\$987		\$1,167	
Grade P		\$1,176		\$996		\$1,176	
Grade Q		\$1,185		\$1,005		\$1,185	
Grade R		\$1,194		\$1,014		\$1,194	
Grade S		\$1,203		\$1,023		\$1,203	
Grade T		\$1,212		\$1,032		\$1,212	
Grade U		\$1,221		\$1,041		\$1,221	
U+ Formula (See pg.12)		(# above U) x 9 + 1221		(# above U) x 9 + 1041		(# above U) x 9 + 1221	
Riser		9		9		9	
COM (Yards)		2.75		2.75		2.75	
COL (sq. ft.)			57		57		57
Standard Seat Cushion		High Resiliency 40		High Resiliency 40		High Resiliency 40	
Finish Options		Y		N		Y	
Nail-head Trim	Small	45	45	45	45	45	45
	Medium	N/A	N/A	N/A	N/A	N/A	N/A

Stocked Finish Codes

Linen (-L) Mica (-M) Sheer Dove (-S) Tobacco (-T)

Collection		Entrée Dining		Entrée Dining		Entrée Dining	
Name		Straight Tall Back Armless Stack Chair with Legs in Stocked Finishes		Straight Tall Back Skirted Dining Chair with Legs in Tobacco Finish		Straight Tall Back Dining Chair with Legs, Finish Choices with buttons	
SKU Options		Fabric Style	Leather Style	No Casters		Fabric Style	Leather Style
		1214-14-L	L-1214-14-L	1215-05-T		1216-05	L-1216-05
		1214-14-M	L-1214-14-M				
		1214-14-T	L-1214-14-T				
Overall Dimensions	Width	19.5		19.5		19.5	
	Depth	27		27		27	
	Height	40.5		41		41	
Seat Height		20		20		20	
Seat Depth		19		19		19	
Inside Width		19.5		19.5		19.5	
Wrap, Carton Weight, Cubes		22, 22, 12.33		22, 22, 12.49		22, 22, 12.49	
		Fabric	Leather	Fabric	Fabric	Leather	
Grade D / Leather 1		\$897	\$1,557	\$1,047	\$1,107	\$1,767	
Grade E / Leather 2		\$906	\$1,647	\$1,059	\$1,116	\$1,857	
Grade F / Leather 3		\$915	\$1,737	\$1,071	\$1,125	\$1,947	
Grade G / Leather 4		\$924	\$1,827	\$1,083	\$1,134	\$2,037	
Grade H / Leather 5		\$933	\$1,917	\$1,095	\$1,143	\$2,127	
Grade J / Leather 6		\$942	\$2,007	\$1,107	\$1,152	\$2,217	
Grade K (COM)		\$951		\$1,119	\$1,161		
Grade L / Leather 8		\$960	\$2,802	\$1,131	\$1,170	\$3,012	
Grade M (COL)		\$969		\$1,143	\$1,179		
Grade N		\$978		\$1,155	\$1,188		
Grade O		\$987		\$1,167	\$1,197		
Grade P		\$996		\$1,179	\$1,206		
Grade Q		\$1,005		\$1,191	\$1,215		
Grade R		\$1,014		\$1,203	\$1,224		
Grade S		\$1,023		\$1,215	\$1,233		
Grade T		\$1,032		\$1,227	\$1,242		
Grade U		\$1,041		\$1,239	\$1,251		
U+ Formula (See pg.12)		(# above U) x 9 + 1041		(# above U) x 12 + 1239	(# above U) x 9 + 1251		
Riser		9		12	9		
COM (Yards)		2.75		4.00	2.75		
COL (sq. ft.)			57	N/A		57	
Standard Seat Cushion		High Resiliency 40		High Resiliency 40		High Resiliency 40	
Finish Options		N		N		Y	
Nail-head Trim	Small	45	45	N/A	45	45	
	Medium	N/A	N/A	N/A	N/A	N/A	

Stocked Finish Codes

Linen (-L) Mica (-M) Sheer Dove (-S) Tobacco (-T)

Collection		Entrée Dining		Entrée Dining		Entrée Dining	
Name		Straight Tall Back Dining Chair		Straight Tall Back Armless Stack Chair		Straight Tall Back Armless Stack Chair	
SKU Options		with Legs in Stocked Finishes with buttons		with Legs, Finish Choices with buttons		with Legs in Stocked Finishes with buttons	
		Fabric Style	Leather Style	Fabric Style	Leather Style	Fabric Style	Leather Style
		1216-05-L	L-1216-05-L	1216-14	L-1216-14	1216-14-L	L-1216-14-L
		1216-05-M	L-1216-05-M			1216-14-M	L-1216-14-M
		1216-05-S	L-1216-05-S			1216-14-T	L-1216-14-T
		1216-05-T	L-1216-05-T				
Overall Dimensions	Width	19.5		19.5		19.5	
	Depth	27		27		27	
	Height	41		40.5		40.5	
Seat Height		20		20		20	
Seat Depth		19		19		19	
Inside Width		19.5		19.5		19.5	
Wrap, Carton Weight, Cubes		22 , 22 , 12.49		22 , 22 , 12.33		22 , 22 , 12.33	
		Fabric	Leather	Fabric	Leather	Fabric	Leather
Grade D / Leather 1		\$927	\$1,587	\$1,107	\$1,767	\$927	\$1,587
Grade E / Leather 2		\$936	\$1,677	\$1,116	\$1,857	\$936	\$1,677
Grade F / Leather 3		\$945	\$1,767	\$1,125	\$1,947	\$945	\$1,767
Grade G / Leather 4		\$954	\$1,857	\$1,134	\$2,037	\$954	\$1,857
Grade H / Leather 5		\$963	\$1,947	\$1,143	\$2,127	\$963	\$1,947
Grade J / Leather 6		\$972	\$2,037	\$1,152	\$2,217	\$972	\$2,037
Grade K (COM)		\$981		\$1,161		\$981	
Grade L / Leather 8		\$990	\$2,832	\$1,170	\$3,012	\$990	\$2,832
Grade M (COL)		\$999		\$1,179		\$999	
Grade N		\$1,008		\$1,188		\$1,008	
Grade O		\$1,017		\$1,197		\$1,017	
Grade P		\$1,026		\$1,206		\$1,026	
Grade Q		\$1,035		\$1,215		\$1,035	
Grade R		\$1,044		\$1,224		\$1,044	
Grade S		\$1,053		\$1,233		\$1,053	
Grade T		\$1,062		\$1,242		\$1,062	
Grade U		\$1,071		\$1,251		\$1,071	
U+ Formula (See pg.12)		(# above U) x 9 + 1071		(# above U) x 9 + 1251		(# above U) x 9 + 1071	
Riser		9		9		9	
COM (Yards)		2.75		2.75		2.75	
COL (sq. ft.)			57		57		57
Standard Seat Cushion		High Resiliency 40		High Resiliency 40		High Resiliency 40	
Finish Options		N		Y		N	
Nail-head Trim	Small	45	45	45	45	45	45
	Medium	N/A	N/A	N/A	N/A	N/A	N/A

Stocked Finish Codes

Linen (-L) Mica (-M) Sheer Dove (-S) Tobacco (-T)

Collection		Entrée Dining	Entrée Dining		Entrée Dining	
Name		Straight Tall Back Skirted Dining Chair with Legs in Tobacco Finish with buttons	Camel Short Back Dining Chair with Legs, Finish Choices		Camel Short Back Dining Chair with Legs in Stocked Finishes	
SKU Options		No Casters 1217-05-T	Fabric Style 1220-05	Leather Style L-1220-05	Fabric Style 1220-05-L 1220-05-M 1220-05-S 1220-05-T	Leather Style L-1220-05-L L-1220-05-M L-1220-05-S L-1220-05-T
Overall Dimensions	Width	19.5	19.5		19.5	
	Depth	27	27		27	
	Height	41	37.5		37.5	
Seat Height		20	20		20	
Seat Depth		19	19		19	
Inside Width		19.5	19.5		19.5	
Wrap, Carton Weight, Cubes		22 , 22 , 12.49	22 , 22 , 11.42		22 , 22 , 11.42	
		Fabric	Fabric	Leather	Fabric	Leather
Grade D / Leather 1		\$1,077	\$1,077	\$1,737	\$897	\$1,557
Grade E / Leather 2		\$1,089	\$1,086	\$1,827	\$906	\$1,647
Grade F / Leather 3		\$1,101	\$1,095	\$1,917	\$915	\$1,737
Grade G / Leather 4		\$1,113	\$1,104	\$2,007	\$924	\$1,827
Grade H / Leather 5		\$1,125	\$1,113	\$2,097	\$933	\$1,917
Grade J / Leather 6		\$1,137	\$1,122	\$2,187	\$942	\$2,007
Grade K (COM)		\$1,149	\$1,131		\$951	
Grade L / Leather 8		\$1,161	\$1,140	\$2,982	\$960	\$2,802
Grade M (COL)		\$1,173	\$1,149		\$969	
Grade N		\$1,185	\$1,158		\$978	
Grade O		\$1,197	\$1,167		\$987	
Grade P		\$1,209	\$1,176		\$996	
Grade Q		\$1,221	\$1,185		\$1,005	
Grade R		\$1,233	\$1,194		\$1,014	
Grade S		\$1,245	\$1,203		\$1,023	
Grade T		\$1,257	\$1,212		\$1,032	
Grade U		\$1,269	\$1,221		\$1,041	
U+ Formula (See pg.12)		(# above U) x 12 + 1269	(# above U) x 9 + 1221		(# above U) x 9 + 1041	
Riser		12	9		9	
COM (Yards)		4.00	2.75		2.75	
COL (sq. ft.)		N/A		57		57
Standard Seat Cushion		High Resiliency 40	High Resiliency 40		High Resiliency 40	
Finish Options		N	Y		N	
Nail-head Trim	Small	N/A	45	45	45	45
	Medium	N/A	N/A	N/A	N/A	N/A

Stocked Finish Codes

Linen (-L) Mica (-M) Sheer Dove (-S) Tobacco (-T)

Collection		Entrée Dining		Entrée Dining		Entrée Dining	
Name		Camel Short Back Armless Stack Chair with Legs, Finish Choices		Camel Short Back Armless Stack Chair with Legs in Stocked Finishes		Camel Short Back Skirted Dining Chair with Legs in Tobacco Finish	
SKU Options		Fabric Style	Leather Style	Fabric Style	Leather Style	No Casters	
		1220-14	L-1220-14	1220-14-L 1220-14-M 1220-14-T	L-1220-14-L L-1220-14-M L-1220-14-T	1221-05-T	
Overall Dimensions	Width	19.5		19.5		19.5	
	Depth	27		27		27	
	Height	37.5		37.5		37.5	
Seat Height		20		20		20	
Seat Depth		19		19		19	
Inside Width		19.5		19.5		19.5	
Wrap, Carton Weight, Cubes		22 , 22 , 11.42		22 , 22 , 11.42		22 , 22 , 11.42	
		Fabric	Leather	Fabric	Leather	Fabric	
Grade D / Leather 1		\$1,077	\$1,737	\$897	\$1,557	\$1,047	
Grade E / Leather 2		\$1,086	\$1,827	\$906	\$1,647	\$1,059	
Grade F / Leather 3		\$1,095	\$1,917	\$915	\$1,737	\$1,071	
Grade G / Leather 4		\$1,104	\$2,007	\$924	\$1,827	\$1,083	
Grade H / Leather 5		\$1,113	\$2,097	\$933	\$1,917	\$1,095	
Grade J / Leather 6		\$1,122	\$2,187	\$942	\$2,007	\$1,107	
Grade K (COM)		\$1,131		\$951		\$1,119	
Grade L / Leather 8		\$1,140	\$2,982	\$960	\$2,802	\$1,131	
Grade M (COL)		\$1,149		\$969		\$1,143	
Grade N		\$1,158		\$978		\$1,155	
Grade O		\$1,167		\$987		\$1,167	
Grade P		\$1,176		\$996		\$1,179	
Grade Q		\$1,185		\$1,005		\$1,191	
Grade R		\$1,194		\$1,014		\$1,203	
Grade S		\$1,203		\$1,023		\$1,215	
Grade T		\$1,212		\$1,032		\$1,227	
Grade U		\$1,221		\$1,041		\$1,239	
U+ Formula (See pg.12)		(# above U) x 9 + 1221		(# above U) x 9 + 1041		(# above U) x 12 + 1239	
Riser		9		9		12	
COM (Yards)		2.75		2.75		4.00	
COL (sq. ft.)		57		57		N/A	
Standard Seat Cushion		High Resiliency 40		High Resiliency 40		High Resiliency 40	
Finish Options		Y		N		N	
Nail-head Trim	Small	45	45	45	45	N/A	
	Medium	N/A	N/A	N/A	N/A	N/A	

Stocked Finish Codes

Linen (-L) Mica (-M) Sheer Dove (-S) Tobacco (-T)

Collection		Entrée Dining		Entrée Dining		Entrée Dining	
Name		Camel Short Back Dining Chair with Legs, Finish Choices with buttons		Camel Short Back Dining Chair with Legs in Stocked Finishes with buttons		Camel Short Back Armless Stack Chair with Legs, Finish Choices with buttons	
SKU Options		Fabric Style	Leather Style	Fabric Style	Leather Style	Fabric Style	Leather Style
		1222-05	L-1222-05	1222-05-L 1222-05-M 1222-05-S 1222-05-T	L-1222-05-L L-1222-05-M L-1222-05-S L-1222-05-T	1222-14	L-1222-14
Overall Dimensions	Width	19.5		19.5		19.5	
	Depth	27		27		27	
	Height	37.5		37.5		37.5	
Seat Height		20		20		20	
Seat Depth		19		19		19	
Inside Width		19.5		19.5		19.5	
Wrap, Carton Weight, Cubes		22 , 22 , 11.42		22 , 22 , 11.42		22 , 22 , 11.42	
		Fabric	Leather	Fabric	Leather	Fabric	Leather
Grade D / Leather 1		\$1,107	\$1,767	\$927	\$1,587	\$1,107	\$1,767
Grade E / Leather 2		\$1,116	\$1,857	\$936	\$1,677	\$1,116	\$1,857
Grade F / Leather 3		\$1,125	\$1,947	\$945	\$1,767	\$1,125	\$1,947
Grade G / Leather 4		\$1,134	\$2,037	\$954	\$1,857	\$1,134	\$2,037
Grade H / Leather 5		\$1,143	\$2,127	\$963	\$1,947	\$1,143	\$2,127
Grade J / Leather 6		\$1,152	\$2,217	\$972	\$2,037	\$1,152	\$2,217
Grade K (COM)		\$1,161		\$981		\$1,161	
Grade L / Leather 8		\$1,170	\$3,012	\$990	\$2,832	\$1,170	\$3,012
Grade M (COL)		\$1,179		\$999		\$1,179	
Grade N		\$1,188		\$1,008		\$1,188	
Grade O		\$1,197		\$1,017		\$1,197	
Grade P		\$1,206		\$1,026		\$1,206	
Grade Q		\$1,215		\$1,035		\$1,215	
Grade R		\$1,224		\$1,044		\$1,224	
Grade S		\$1,233		\$1,053		\$1,233	
Grade T		\$1,242		\$1,062		\$1,242	
Grade U		\$1,251		\$1,071		\$1,251	
U+ Formula (See pg.12)		(# above U) x 9 + 1251		#REF!		(# above U) x 9 + 1251	
Riser		9		9		9	
COM (Yards)		2.75		#REF!		2.75	
COL (sq. ft.)			57		#REF!		57
Standard Seat Cushion		High Resiliency 40		High Resiliency 40		High Resiliency 40	
Finish Options		Y		N		Y	
Nail-head Trim	Small	45	45	45	45	45	45
	Medium	N/A	N/A	N/A	N/A	N/A	N/A

Stocked Finish Codes

Linen (-L) Mica (-M) Sheer Dove (-S) Tobacco (-T)

Collection		Entrée Dining		Entrée Dining		Entrée Dining	
Name		Camel Short Back Armless Stack Chair with Legs in Stocked Finishes with buttons		Camel Short Back Skirted Dining Chair with Legs in Tobacco Finish with buttons		Camel Tall Back Dining Chair with Legs, Finish Choices	
SKU Options		Fabric Style	Leather Style	No Casters		Fabric Style	Leather Style
		1222-14-L	L-1222-14-L	1223-05-T		1224-05	L-1224-05
		1222-14-M	L-1222-14-M				
		1222-14-T	L-1222-14-T				
Overall Dimensions	Width	19.5		19.5		19.5	
	Depth	27		27		27	
	Height	37.5		37.5		41.5	
Seat Height		20		20		20	
Seat Depth		19		19		19	
Inside Width		19.5		19.5		19.5	
Wrap, Carton Weight, Cubes		22, 22, 11.42		22, 22, 11.42		22, 33, 15.74	
		Fabric	Leather	Fabric	Fabric	Leather	
Grade D / Leather 1		\$927	\$1,587	\$1,077	\$1,077	\$1,737	
Grade E / Leather 2		\$936	\$1,677	\$1,089	\$1,086	\$1,827	
Grade F / Leather 3		\$945	\$1,767	\$1,101	\$1,095	\$1,917	
Grade G / Leather 4		\$954	\$1,857	\$1,113	\$1,104	\$2,007	
Grade H / Leather 5		\$963	\$1,947	\$1,125	\$1,113	\$2,097	
Grade J / Leather 6		\$972	\$2,037	\$1,137	\$1,122	\$2,187	
Grade K (COM)		\$981		\$1,149	\$1,131		
Grade L / Leather 8		\$990	\$2,832	\$1,161	\$1,140	\$2,982	
Grade M (COL)		\$999		\$1,173	\$1,149		
Grade N		\$1,008		\$1,185	\$1,158		
Grade O		\$1,017		\$1,197	\$1,167		
Grade P		\$1,026		\$1,209	\$1,176		
Grade Q		\$1,035		\$1,221	\$1,185		
Grade R		\$1,044		\$1,233	\$1,194		
Grade S		\$1,053		\$1,245	\$1,203		
Grade T		\$1,062		\$1,257	\$1,212		
Grade U		\$1,071		\$1,269	\$1,221		
U+ Formula (See pg.12)		(# above U) x 9 + 1071		(# above U) x 12 + 1269	(# above U) x 9 + 1221		
Riser		9		12	9		
COM (Yards)		2.75		4.00	2.75		
COL (sq. ft.)			57	N/A		57	
Standard Seat Cushion		High Resiliency 40		High Resiliency 40		High Resiliency 40	
Finish Options		N		N		Y	
Nail-head Trim	Small	45	45	N/A	45	45	
	Medium	N/A	N/A	N/A	N/A	N/A	

Stocked Finish Codes

Linen (-L) Mica (-M) Sheer Dove (-S) Tobacco (-T)

Collection		Entrée Dining		Entrée Dining		Entrée Dining	
Name		Camel Tall Back Dining Chair with Legs in Stocked Finishes		Camel Tall Back Armless Stack Chair with Legs, Finish Choices		Camel Tall Back Armless Stack Chair with Legs in Stocked Finishes	
SKU Options		Fabric Style	Leather Style	Fabric Style	Leather Style	Fabric Style	Leather Style
		1224-05-L	L-1224-05-L	1224-14	L-1224-14	1224-14-L	L-1224-14-L
		1224-05-M	L-1224-05-M			1224-14-M	L-1224-14-M
		1224-05-S	L-1224-05-S			1224-14-T	L-1224-14-T
		1224-05-T	L-1224-05-T				
Overall Dimensions	Width	19.5		19.5		19.5	
	Depth	27		27		27	
	Height	41.5		41.5		41.5	
Seat Height		20		20		20	
Seat Depth		19		19		19	
Inside Width		19.5		19.5		19.5	
Wrap, Carton Weight, Cubes		22 , 22 , 12.64		22 , 22 , 12.64		22 , 22 , 12.64	
		Fabric	Leather	Fabric	Leather	Fabric	Leather
Grade D / Leather 1		\$897	\$1,557	\$1,077	\$1,737	\$897	\$1,557
Grade E / Leather 2		\$906	\$1,647	\$1,086	\$1,827	\$906	\$1,647
Grade F / Leather 3		\$915	\$1,737	\$1,095	\$1,917	\$915	\$1,737
Grade G / Leather 4		\$924	\$1,827	\$1,104	\$2,007	\$924	\$1,827
Grade H / Leather 5		\$933	\$1,917	\$1,113	\$2,097	\$933	\$1,917
Grade J / Leather 6		\$942	\$2,007	\$1,122	\$2,187	\$942	\$2,007
Grade K (COM)		\$951		\$1,131		\$951	
Grade L / Leather 8		\$960	\$2,802	\$1,140	\$2,982	\$960	\$2,802
Grade M (COL)		\$969		\$1,149		\$969	
Grade N		\$978		\$1,158		\$978	
Grade O		\$987		\$1,167		\$987	
Grade P		\$996		\$1,176		\$996	
Grade Q		\$1,005		\$1,185		\$1,005	
Grade R		\$1,014		\$1,194		\$1,014	
Grade S		\$1,023		\$1,203		\$1,023	
Grade T		\$1,032		\$1,212		\$1,032	
Grade U		\$1,041		\$1,221		\$1,041	
U+ Formula (See pg.12)		(# above U) x 9 + 1041		(# above U) x 9 + 1221		(# above U) x 9 + 1041	
Riser		9		9		9	
COM (Yards)		2.75		2.75		2.75	
COL (sq. ft.)			57		57		57
Standard Seat Cushion		High Resiliency 40		High Resiliency 40		High Resiliency 40	
Finish Options		N		Y		N	
Nail-head Trim	Small	45	45	45	45	45	45
	Medium	N/A	N/A	N/A	N/A	N/A	N/A

Stocked Finish Codes

Linen (-L) Mica (-M) Sheer Dove (-S) Tobacco (-T)

Collection		Entrée Dining	Entrée Dining		Entrée Dining	
Name		Camel Tall Back Skirted Dining Chair with Legs in Tobacco Finish	Camel Tall Back Dining Chair with Legs, Finish Choices with buttons		Camel Tall Back Dining Chair with Legs in Stocked Finishes with buttons	
SKU Options		No Casters 1223-05-T	Fabric Style 1226-05	Leather Style L-1226-05	Fabric Style 1226-05-L 1226-05-M 1226-05-S 1226-05-T	Leather Style L-1226-05-L L-1226-05-M L-1226-05-S L-1226-05-T
Overall Dimensions	Width	19.5	19.5		19.5	
	Depth	27	27		27	
	Height	41.5	41.5		41.5	
Seat Height		20	20		20	
Seat Depth		19	19		19	
Inside Width		19.5	19.5		19.5	
Wrap, Carton Weight, Cubes		22, 22, 12.64	22, 22, 12.64		22, 22, 12.64	
		Fabric	Fabric	Leather	Fabric	Leather
Grade D / Leather 1		\$1,047	\$1,107	\$1,767	\$927	\$1,587
Grade E / Leather 2		\$1,059	\$1,116	\$1,857	\$936	\$1,677
Grade F / Leather 3		\$1,071	\$1,125	\$1,947	\$945	\$1,767
Grade G / Leather 4		\$1,083	\$1,134	\$2,037	\$954	\$1,857
Grade H / Leather 5		\$1,095	\$1,143	\$2,127	\$963	\$1,947
Grade J / Leather 6		\$1,107	\$1,152	\$2,217	\$972	\$2,037
Grade K (COM)		\$1,119	\$1,161		\$981	
Grade L / Leather 8		\$1,131	\$1,170	\$3,012	\$990	\$2,832
Grade M (COL)		\$1,143	\$1,179		\$999	
Grade N		\$1,155	\$1,188		\$1,008	
Grade O		\$1,167	\$1,197		\$1,017	
Grade P		\$1,179	\$1,206		\$1,026	
Grade Q		\$1,191	\$1,215		\$1,035	
Grade R		\$1,203	\$1,224		\$1,044	
Grade S		\$1,215	\$1,233		\$1,053	
Grade T		\$1,227	\$1,242		\$1,062	
Grade U		\$1,239	\$1,251		\$1,071	
U+ Formula (See pg.12)		(# above U) x 12 + 1239	(# above U) x 9 + 1251		(# above U) x 9 + 1071	
Riser		12	9		9	
COM (Yards)		4.00	2.75		2.75	
COL (sq. ft.)		N/A		57		57
Standard Seat Cushion		High Resiliency 40	High Resiliency 40		High Resiliency 40	
Finish Options		N	Y		N	
Nail-head Trim	Small	N/A	45	45	45	45
	Medium	N/A	N/A	N/A	N/A	N/A

Stocked Finish Codes

Linen (-L) Mica (-M) Sheer Dove (-S) Tobacco (-T)

Collection		Entrée Dining		Entrée Dining		Entrée Dining	
Name		Camel Tall Back Armless Stack Chair with Legs, Finish Choices with buttons		Camel Tall Back Armless Stack Chair with Legs in Stocked Finishes with buttons		Camel Tall Back Skirted Dining Chair with Legs in Tobacco Finish with buttons	
SKU Options		Fabric Style	Leather Style	Fabric Style	Leather Style	No Casters	
		1226-14	L-1226-14	1226-14-L 1226-14-M 1226-14-T	L-1226-14-L L-1226-14-M L-1226-14-T	1227-05-T	
Overall Dimensions	Width	19.5		19.5		19.5	
	Depth	27		27		27	
	Height	41.5		41.5		41.5	
Seat Height		20		20		20	
Seat Depth		19		19		19	
Inside Width		19.5		19.5		19.5	
Wrap, Carton Weight, Cubes		22 , 22 , 12.64		22 , 22 , 12.64		22 , 22 , 12.64	
		Fabric	Leather	Fabric	Leather	Fabric	
Grade D / Leather 1		\$1,107	\$1,767	\$927	\$1,587	\$1,077	
Grade E / Leather 2		\$1,116	\$1,857	\$936	\$1,677	\$1,089	
Grade F / Leather 3		\$1,125	\$1,947	\$945	\$1,767	\$1,101	
Grade G / Leather 4		\$1,134	\$2,037	\$954	\$1,857	\$1,113	
Grade H / Leather 5		\$1,143	\$2,127	\$963	\$1,947	\$1,125	
Grade J / Leather 6		\$1,152	\$2,217	\$972	\$2,037	\$1,137	
Grade K (COM)		\$1,161		\$981		\$1,149	
Grade L / Leather 8		\$1,170	\$3,012	\$990	\$2,832	\$1,161	
Grade M (COL)		\$1,179		\$999		\$1,173	
Grade N		\$1,188		\$1,008		\$1,185	
Grade O		\$1,197		\$1,017		\$1,197	
Grade P		\$1,206		\$1,026		\$1,209	
Grade Q		\$1,215		\$1,035		\$1,221	
Grade R		\$1,224		\$1,044		\$1,233	
Grade S		\$1,233		\$1,053		\$1,245	
Grade T		\$1,242		\$1,062		\$1,257	
Grade U		\$1,251		\$1,071		\$1,269	
U+ Formula (See pg.12)		(# above U) x 9 + 1251		(# above U) x 9 + 1071		(# above U) x 12 + 1269	
Riser		9		9		12	
COM (Yards)		2.75		2.75		4.00	
COL (sq. ft.)		57		57		N/A	
Standard Seat Cushion		High Resiliency 40		High Resiliency 40		High Resiliency 40	
Finish Options		Y		N		N	
Nail-head Trim	Small	45	45	45	45	N/A	
	Medium	N/A	N/A	N/A	N/A	N/A	

Stocked Finish Codes

Linen (-L) Mica (-M) Sheer Dove (-S) Tobacco (-T)

Collection		Entrée Dining		Entrée Dining		Entrée Dining	
Name		Pull Short Back Dining Chair with Legs, Finish Choices		Pull Short Back Dining Chair with Legs in Stocked Finishes		Pull Short Back Armless Stack Chair with Legs, Finish Choices	
SKU Options		Fabric Style	Leather Style	Fabric Style	Leather Style	Fabric Style	Leather Style
		1230-05	L-1230-05	1230-05-L	L-1230-05-L	1230-14	L-1230-14
				1230-05-M	L-1230-05-M		
				1230-05-S	L-1230-05-S		
				1230-05-T	L-1230-05-T		
Overall Dimensions	Width	19.5		19.5		19.5	
	Depth	27		27		27	
	Height	41.5		37.5		36.5	
Seat Height		20		20		20	
Seat Depth		19		19		19	
Inside Width		19.5		19.5		19.5	
Wrap, Carton Weight, Cubes		22 , 22 , 21.65		22 , 22 , 11.42		22 , 22 , 11.12	
		Fabric	Leather	Fabric	Leather	Fabric	Leather
Grade D / Leather 1		\$1,107	\$1,767	\$927	\$1,587	\$1,107	\$1,767
Grade E / Leather 2		\$1,116	\$1,857	\$936	\$1,677	\$1,116	\$1,857
Grade F / Leather 3		\$1,125	\$1,947	\$945	\$1,767	\$1,125	\$1,947
Grade G / Leather 4		\$1,134	\$2,037	\$954	\$1,857	\$1,134	\$2,037
Grade H / Leather 5		\$1,143	\$2,127	\$963	\$1,947	\$1,143	\$2,127
Grade J / Leather 6		\$1,152	\$2,217	\$972	\$2,037	\$1,152	\$2,217
Grade K (COM)		\$1,161		\$981		\$1,161	
Grade L / Leather 8		\$1,170	\$3,012	\$990	\$2,832	\$1,170	\$3,012
Grade M (COL)		\$1,179		\$999		\$1,179	
Grade N		\$1,188		\$1,008		\$1,188	
Grade O		\$1,197		\$1,017		\$1,197	
Grade P		\$1,206		\$1,026		\$1,206	
Grade Q		\$1,215		\$1,035		\$1,215	
Grade R		\$1,224		\$1,044		\$1,224	
Grade S		\$1,233		\$1,053		\$1,233	
Grade T		\$1,242		\$1,062		\$1,242	
Grade U		\$1,251		\$1,071		\$1,251	
U+ Formula (See pg.12)		(# above U) x 9 + 1251		(# above U) x 9 + 1071		(# above U) x 9 + 1251	
Riser		9		9		9	
COM (Yards)		2.75		2.75		2.75	
COL (sq. ft.)			57		57		57
Standard Seat Cushion		High Resiliency 40		High Resiliency 40		High Resiliency 40	
Finish Options		Y		N		Y	
Nail-head Trim	Small	45	45	45	45	45	45
	Medium	N/A	N/A	N/A	N/A	N/A	N/A

Stocked Finish Codes

Linen (-L) Mica (-M) Sheer Dove (-S) Tobacco (-T)

Collection		Entrée Dining		Entrée Dining		Entrée Dining	
Name		Pull Short Back Armless Stack Chair with Legs in Stocked Finishes		Pull Short Back Skirted Dining Chair		Pull Short Back Skirted Dining Chair Pull in Stocked Finishes	
SKU Options		Fabric Style	Leather Style	No Casters		No Casters	
		1230-14-L	L-1230-14-L	1231-05		1231-05-L	
		1230-14-M	L-1230-14-M			1231-05-M	
		1230-14-T	L-1230-14-T			1231-05-T	
Overall Dimensions	Width	19.5		19.5		19.5	
	Depth	27		27		27	
	Height	36.5		36.5		37.5	
Seat Height		20		20		20	
Seat Depth		19		19		19	
Inside Width		19.5		19.5		19.5	
Wrap, Carton Weight, Cubes		22, 22, 11.12		22, 22, 11.12		22, 22, 11.42	
		Fabric	Leather	Fabric		Fabric	
Grade D / Leather 1		\$927	\$1,587	\$1,227		\$1,077	
Grade E / Leather 2		\$936	\$1,677	\$1,239		\$1,089	
Grade F / Leather 3		\$945	\$1,767	\$1,251		\$1,101	
Grade G / Leather 4		\$954	\$1,857	\$1,263		\$1,113	
Grade H / Leather 5		\$963	\$1,947	\$1,275		\$1,125	
Grade J / Leather 6		\$972	\$2,037	\$1,287		\$1,137	
Grade K (COM)		\$981		\$1,299		\$1,149	
Grade L / Leather 8		\$990	\$2,832	\$1,311		\$1,161	
Grade M (COL)		\$999		\$1,323		\$1,173	
Grade N		\$1,008		\$1,335		\$1,185	
Grade O		\$1,017		\$1,347		\$1,197	
Grade P		\$1,026		\$1,359		\$1,209	
Grade Q		\$1,035		\$1,371		\$1,221	
Grade R		\$1,044		\$1,383		\$1,233	
Grade S		\$1,053		\$1,395		\$1,245	
Grade T		\$1,062		\$1,407		\$1,257	
Grade U		\$1,071		\$1,419		\$1,269	
U+ Formula (See pg.12)		(# above U) x 9 + 1071		(# above U) x 12 + 1419		(# above U) x 12 + 1269	
Riser		9		12		12	
COM (Yards)		2.75		3.75		3.75	
COL (sq. ft.)				N/A		N/A	
Standard Seat Cushion		High Resiliency 40		High Resiliency 40		High Resiliency 40	
Finish Options		N		Y		N	
Nail-head Trim	Small	45	45	N/A		N/A	
	Medium	N/A	N/A	N/A		N/A	

Stocked Finish Codes

Linen (-L) Mica (-M) Sheer Dove (-S) Tobacco (-T)

Collection		Entrée Dining		Entrée Dining		Entrée Dining	
Name		Pull Short Back Dining Chair with Legs, Finish Choices with buttons		Pull Short Back Dining Chair with Legs in Stocked Finishes		Pull Short Back Armless Stack Chair with Legs, Finish Choices with buttons	
SKU Options		Fabric Style	Leather Style	Fabric Style	Leather Style	Fabric Style	Leather Style
		1232-05	L-1232-05	1232-05-L	L-1232-05-L	1232-14	L-1232-14
				1232-05-M	L-1232-05-M		
				1232-05-S	L-1232-05-S		
				1232-05-T	L-1232-05-T		
Overall Dimensions	Width	19.5		19.5		19.5	
	Depth	27		27		27	
	Height	37.5		37.5		36.5	
Seat Height		20		20		20	
Seat Depth		19		19		19	
Inside Width		19.5		19.5		19.5	
Wrap, Carton Weight, Cubes		22, 22, 11.42		22, 22, 11.42		22, 22, 11.12	
		Fabric	Leather	Fabric	Leather	Fabric	Leather
Grade D / Leather 1		\$1,137	\$1,797	\$957	\$1,617	\$1,137	\$1,797
Grade E / Leather 2		\$1,146	\$1,887	\$966	\$1,707	\$1,146	\$1,887
Grade F / Leather 3		\$1,155	\$1,977	\$975	\$1,797	\$1,155	\$1,977
Grade G / Leather 4		\$1,164	\$2,067	\$984	\$1,887	\$1,164	\$2,067
Grade H / Leather 5		\$1,173	\$2,157	\$993	\$1,977	\$1,173	\$2,157
Grade J / Leather 6		\$1,182	\$2,247	\$1,002	\$2,067	\$1,182	\$2,247
Grade K (COM)		\$1,191		\$1,011		\$1,191	
Grade L / Leather 8		\$1,200	\$3,042	\$1,020	\$2,862	\$1,200	\$3,042
Grade M (COL)		\$1,209		\$1,029		\$1,209	
Grade N		\$1,218		\$1,038		\$1,218	
Grade O		\$1,227		\$1,047		\$1,227	
Grade P		\$1,236		\$1,056		\$1,236	
Grade Q		\$1,245		\$1,065		\$1,245	
Grade R		\$1,254		\$1,074		\$1,254	
Grade S		\$1,263		\$1,083		\$1,263	
Grade T		\$1,272		\$1,092		\$1,272	
Grade U		\$1,281		\$1,101		\$1,281	
U+ Formula (See pg.12)		(# above U) x 9 + 1281		(# above U) x 9 + 1101		(# above U) x 9 + 1281	
Riser		9		9		9	
COM (Yards)		2.75		2.75		2.75	
COL (sq. ft.)			57		57		57
Standard Seat Cushion		High Resiliency 40		High Resiliency 40		High Resiliency 40	
Finish Options		Y		N		Y	
Nail-head Trim	Small	45	45	45	45	45	45
	Medium	N/A	N/A	N/A	N/A	N/A	N/A

Stocked Finish Codes

Linen (-L) Mica (-M) Sheer Dove (-S) Tobacco (-T)

Collection		Entrée Dining		Entrée Dining		Entrée Dining	
Name		Pull Short Back Armless Stack Chair with Legs in Stocked Finishes with buttons		Pull Short Back Skirted Dining Chair with buttons		Pull Short Back Skirted Dining Chair Pull in Stocked Finishes with buttons	
SKU Options		Fabric Style	Leather Style	No Casters		No Casters	
		1232-14-L	L-1232-14-L	1233-05		1233-05-L	
		1232-14-M	L-1232-14-M			1233-05-M	
		1232-14-T	L-1232-14-T			1233-05-T	
Overall Dimensions	Width	19.5		19.5		19.5	
	Depth	27		27		27	
	Height	36.5		36.5		36.5	
Seat Height		20		20		20	
Seat Depth		19		19		19	
Inside Width		19.5		19.5		19.5	
Wrap, Carton Weight, Cubes		22, 22, 11.12		22, 22, 11.12		22, 22, 11.12	
		Fabric	Leather	Fabric		Fabric	
Grade D / Leather 1		\$957	\$1,617	\$1,257		\$1,107	
Grade E / Leather 2		\$966	\$1,707	\$1,269		\$1,119	
Grade F / Leather 3		\$975	\$1,797	\$1,281		\$1,131	
Grade G / Leather 4		\$984	\$1,887	\$1,293		\$1,143	
Grade H / Leather 5		\$993	\$1,977	\$1,305		\$1,155	
Grade J / Leather 6		\$1,002	\$2,067	\$1,317		\$1,167	
Grade K (COM)		\$1,011		\$1,329		\$1,179	
Grade L / Leather 8		\$1,020	\$2,862	\$1,341		\$1,191	
Grade M (COL)		\$1,029		\$1,353		\$1,203	
Grade N		\$1,038		\$1,365		\$1,215	
Grade O		\$1,047		\$1,377		\$1,227	
Grade P		\$1,056		\$1,389		\$1,239	
Grade Q		\$1,065		\$1,401		\$1,251	
Grade R		\$1,074		\$1,413		\$1,263	
Grade S		\$1,083		\$1,425		\$1,275	
Grade T		\$1,092		\$1,437		\$1,287	
Grade U		\$1,101		\$1,449		\$1,299	
U+ Formula (See pg.12)		(# above U) x 9 + 1101		(# above U) x 12 + 1449		(# above U) x 12 + 1299	
Riser		9		12		12	
COM (Yards)		2.75		3.75		3.75	
COL (sq. ft.)				N/A		N/A	
Standard Seat Cushion		High Resiliency 40		High Resiliency 40		High Resiliency 40	
Finish Options		N		Y		N	
Nail-head Trim	Small	45	45	N/A		N/A	
	Medium	N/A	N/A	N/A		N/A	

Stocked Finish Codes

Linen (-L) Mica (-M) Sheer Dove (-S) Tobacco (-T)

Collection		Entrée Dining		Entrée Dining		Entrée Dining	
Name		Pull Tall Back Dining Chair with Legs, Finish Choices		Pull Tall Back Dining Chair with Legs in Stocked Finishes		Pull Tall Back Armless Stack Chair with Legs, Finish Choices	
SKU Options		Fabric Style	Leather Style	Fabric Style	Leather Style	Fabric Style	Leather Style
		1234-05	L-1234-05	1234-05-L	L-1234-05-L	1234-14	L-1234-14
				1234-05-M	L-1234-05-M		
				1234-05-S	L-1234-05-S		
				1234-05-T	L-1234-05-T		
Overall Dimensions	Width	19.5		19.5		19.5	
	Depth	27		27		27	
	Height	41.5		41.5		40.5	
Seat Height		20		20		20	
Seat Depth		19		19		19	
Inside Width		19.5		19.5		19.5	
Wrap, Carton Weight, Cubes		22 , 22 , 12.64		22 , 22 , 12.64		22 , 22 , 12.33	
		Fabric	Leather	Fabric	Leather	Fabric	Leather
Grade D / Leather 1		\$1,107	\$1,767	\$927	\$1,587	\$1,107	\$1,767
Grade E / Leather 2		\$1,116	\$1,857	\$936	\$1,677	\$1,116	\$1,857
Grade F / Leather 3		\$1,125	\$1,947	\$945	\$1,767	\$1,125	\$1,947
Grade G / Leather 4		\$1,134	\$2,037	\$954	\$1,857	\$1,134	\$2,037
Grade H / Leather 5		\$1,143	\$2,127	\$963	\$1,947	\$1,143	\$2,127
Grade J / Leather 6		\$1,152	\$2,217	\$972	\$2,037	\$1,152	\$2,217
Grade K (COM)		\$1,161		\$981		\$1,161	
Grade L / Leather 8		\$1,170	\$3,012	\$990	\$2,832	\$1,170	\$3,012
Grade M (COL)		\$1,179		\$999		\$1,179	
Grade N		\$1,188		\$1,008		\$1,188	
Grade O		\$1,197		\$1,017		\$1,197	
Grade P		\$1,206		\$1,026		\$1,206	
Grade Q		\$1,215		\$1,035		\$1,215	
Grade R		\$1,224		\$1,044		\$1,224	
Grade S		\$1,233		\$1,053		\$1,233	
Grade T		\$1,242		\$1,062		\$1,242	
Grade U		\$1,251		\$1,071		\$1,251	
U+ Formula (See pg.12)		(# above U) x 9 + 1251		(# above U) x 9 + 1071		(# above U) x 9 + 1251	
Riser		9		9		9	
COM (Yards)		2.75		2.75		2.75	
COL (sq. ft.)			57		57		57
Standard Seat Cushion		High Resiliency 40		High Resiliency 40		High Resiliency 40	
Finish Options		Y		N		Y	
Nail-head Trim	Small	45	45	45	45	45	45
	Medium	N/A	N/A	N/A	N/A	N/A	N/A

Stocked Finish Codes

Linen (-L)

Mica (-M)

Sheer Dove (-S)

Tobacco (-T)

Collection		Entrée Dining		Entrée Dining		Entrée Dining	
Name		Pull Tall Back Armless Stack Chair with Legs in Stocked Finishes		Pull Tall Back Skirted Dining Chair		Pull Tall Back Skirted Dining Chair Pull in Stocked Finishes	
SKU Options		Fabric Style	Leather Style	No Casters		No Casters	
		1234-14-L	L-1234-14-L	1235-05		1235-05-L	
		1234-14-M	L-1234-14-M			1235-05-M	
		1234-14-T	L-1234-14-T			1235-05-T	
Overall Dimensions	Width	19.5		19.5		19.5	
	Depth	27		27		27	
	Height	40.5		40.5		40.5	
Seat Height		20		20		20	
Seat Depth		19		19		19	
Inside Width		19.5		19.5		19.5	
Wrap, Carton Weight, Cubes		22, 22, 12.33		22, 22, 12.33		22, 22, 12.33	
		Fabric	Leather	Fabric		Fabric	
Grade D / Leather 1		\$927	\$1,587	\$1,227		\$1,077	
Grade E / Leather 2		\$936	\$1,677	\$1,239		\$1,089	
Grade F / Leather 3		\$945	\$1,767	\$1,251		\$1,101	
Grade G / Leather 4		\$954	\$1,857	\$1,263		\$1,113	
Grade H / Leather 5		\$963	\$1,947	\$1,275		\$1,125	
Grade J / Leather 6		\$972	\$2,037	\$1,287		\$1,137	
Grade K (COM)		\$981		\$1,299		\$1,149	
Grade L / Leather 8		\$990	\$2,832	\$1,311		\$1,161	
Grade M (COL)		\$999		\$1,323		\$1,173	
Grade N		\$1,008		\$1,335		\$1,185	
Grade O		\$1,017		\$1,347		\$1,197	
Grade P		\$1,026		\$1,359		\$1,209	
Grade Q		\$1,035		\$1,371		\$1,221	
Grade R		\$1,044		\$1,383		\$1,233	
Grade S		\$1,053		\$1,395		\$1,245	
Grade T		\$1,062		\$1,407		\$1,257	
Grade U		\$1,071		\$1,419		\$1,269	
U+ Formula (See pg.12)		(# above U) x 9 + 1071		(# above U) x 12 + 1419		(# above U) x 12 + 1269	
Riser		9		12		12	
COM (Yards)		2.75		3.75		3.75	
COL (sq. ft.)				N/A		N/A	
Standard Seat Cushion		High Resiliency 40		High Resiliency 40		High Resiliency 40	
Finish Options		N		Y		N	
Nail-head Trim	Small	45	45	N/A		N/A	
	Medium	N/A	N/A	N/A		N/A	

Stocked Finish Codes

Linen (-L) Mica (-M) Sheer Dove (-S) Tobacco (-T)

Collection		Entrée Dining		Entrée Dining		Entrée Dining	
Name		Pull Tall Back Dining Chair with Legs, Finish Choices with buttons		Pull Tall Back Dining Chair with Legs in Stocked Finishes with buttons		Pull Tall Back Armless Stack Chair with Legs, Finish Choices with buttons	
SKU Options		Fabric Style	Leather Style	Fabric Style	Leather Style	Fabric Style	Leather Style
		1236-05	L-1236-05	1236-05-L 1236-05-M 1236-05-S 1236-05-T	L-1236-05-L L-1236-05-M L-1236-05-S L-1236-05-T	1236-14	L-1236-14
Overall Dimensions	Width	19.5		19.5		19.5	
	Depth	27		27		27	
	Height	41.5		41.5		40.5	
Seat Height		20		20		20	
Seat Depth		19		19		19	
Inside Width		19.5		19.5		19.5	
Wrap, Carton Weight, Cubes		22 , 22 , 12.64		22 , 22 , 12.64		22 , 22 , 12.33	
		Fabric	Leather	Fabric	Leather	Fabric	Leather
Grade D / Leather 1		\$1,137	\$1,797	\$957	\$1,617	\$1,137	\$1,797
Grade E / Leather 2		\$1,146	\$1,887	\$966	\$1,707	\$1,146	\$1,887
Grade F / Leather 3		\$1,155	\$1,977	\$975	\$1,797	\$1,155	\$1,977
Grade G / Leather 4		\$1,164	\$2,067	\$984	\$1,887	\$1,164	\$2,067
Grade H / Leather 5		\$1,173	\$2,157	\$993	\$1,977	\$1,173	\$2,157
Grade J / Leather 6		\$1,182	\$2,247	\$1,002	\$2,067	\$1,182	\$2,247
Grade K (COM)		\$1,191		\$1,011		\$1,191	
Grade L / Leather 8		\$1,200	\$3,042	\$1,020	\$2,862	\$1,200	\$3,042
Grade M (COL)		\$1,209		\$1,029		\$1,209	
Grade N		\$1,218		\$1,038		\$1,218	
Grade O		\$1,227		\$1,047		\$1,227	
Grade P		\$1,236		\$1,056		\$1,236	
Grade Q		\$1,245		\$1,065		\$1,245	
Grade R		\$1,254		\$1,074		\$1,254	
Grade S		\$1,263		\$1,083		\$1,263	
Grade T		\$1,272		\$1,092		\$1,272	
Grade U		\$1,281		\$1,101		\$1,281	
U+ Formula (See pg.12)		(# above U) x 9 + 1281		(# above U) x 9 + 1101		(# above U) x 9 + 1281	
Riser		9		9		9	
COM (Yards)		2.75		2.75		2.75	
COL (sq. ft.)			57		57		57
Standard Seat Cushion		High Resiliency 40		High Resiliency 40		High Resiliency 40	
Finish Options		Y		N		Y	
Nail-head Trim	Small	45	45	45	45	45	45
	Medium	N/A	N/A	N/A	N/A	N/A	N/A

Stocked Finish Codes

Linen (-L)

Mica (-M)

Sheer Dove (-S)

Tobacco (-T)

Collection		Entrée Dining		Entrée Dining		Entrée Dining	
Name		Pull Tall Back Armless Stack Chair with Legs in Stocked Finishes with buttons		Pull Tall Back Skirted Dining Chair with buttons		Pull Tall Back Skirted Dining Chair Pull in Stocked Finishes with buttons	
SKU Options		Fabric Style	Leather Style	No Casters		No Casters	
		1236-14-L	L-1236-14-L	1237-05		1237-05-L	
		1236-14-M	L-1236-14-M			1237-05-M	
		1236-14-T	L-1236-14-T			1237-05-T	
Overall Dimensions	Width	19.5		19.5		19.5	
	Depth	27		27		27	
	Height	40.5		40.5		40.5	
Seat Height		20		20		20	
Seat Depth		19		19		19	
Inside Width		19.5		19.5		19.5	
Wrap, Carton Weight, Cubes		22, 22, 12.33		22, 22, 12.33		22, 22, 12.33	
		Fabric	Leather	Fabric		Fabric	
Grade D / Leather 1		\$957	\$1,617	\$1,257		\$1,107	
Grade E / Leather 2		\$966	\$1,707	\$1,269		\$1,119	
Grade F / Leather 3		\$975	\$1,797	\$1,281		\$1,131	
Grade G / Leather 4		\$984	\$1,887	\$1,293		\$1,143	
Grade H / Leather 5		\$993	\$1,977	\$1,305		\$1,155	
Grade J / Leather 6		\$1,002	\$2,067	\$1,317		\$1,167	
Grade K (COM)		\$1,011		\$1,329		\$1,179	
Grade L / Leather 8		\$1,020	\$2,862	\$1,341		\$1,191	
Grade M (COL)		\$1,029		\$1,353		\$1,203	
Grade N		\$1,038		\$1,365		\$1,215	
Grade O		\$1,047		\$1,377		\$1,227	
Grade P		\$1,056		\$1,389		\$1,239	
Grade Q		\$1,065		\$1,401		\$1,251	
Grade R		\$1,074		\$1,413		\$1,263	
Grade S		\$1,083		\$1,425		\$1,275	
Grade T		\$1,092		\$1,437		\$1,287	
Grade U		\$1,101		\$1,449		\$1,299	
U+ Formula (See pg.12)		(# above U) x 9 + 1101		(# above U) x 12 + 1449		(# above U) x 12 + 1299	
Riser		9		12		12	
COM (Yards)		2.75		3.75		3.75	
COL (sq. ft.)				N/A		N/A	
Standard Seat Cushion		High Resiliency 40		High Resiliency 40		High Resiliency 40	
Finish Options		N		Y		N	
Nail-head Trim	Small	45	45	N/A		N/A	
	Medium	N/A	N/A	N/A		N/A	

Stocked Finish Codes

Linen (-L) Mica (-M) Sheer Dove (-S) Tobacco (-T)

Collection		Entrée Dining		Entrée Dining		Entrée Dining	
Name		Empire Short Back Dining Chair with Legs, Finish Choices		Empire Short Back Dining Chair with Legs in Stocked Finishes		Empire Short Back Armless Stack Chair with Legs, Finish Choices	
SKU Options		Fabric Style	Leather Style	Fabric Style	Leather Style	Fabric Style	Leather Style
		1240-05	L-1240-05	1240-05-L	L-1240-05-L	1240-14	L-1240-14
				1240-05-M	L-1240-05-M		
				1240-05-S	L-1240-05-S		
				1240-05-T	L-1240-05-T		
Overall Dimensions	Width	19.5		19.5		19.5	
	Depth	27		27		27	
	Height	38		38		38	
Seat Height		20		20		20	
Seat Depth		19		19		19	
Inside Width		19.5		19.5		19.5	
Wrap, Carton Weight, Cubes		22 , 22 , 11.57		22 , 22 , 11.57		22 , 22 , 11.57	
		Fabric	Leather	Fabric	Leather	Fabric	Leather
Grade D / Leather 1		\$1,107	\$1,767	\$927	\$1,587	\$1,107	\$1,767
Grade E / Leather 2		\$1,116	\$1,857	\$936	\$1,677	\$1,116	\$1,857
Grade F / Leather 3		\$1,125	\$1,947	\$945	\$1,767	\$1,125	\$1,947
Grade G / Leather 4		\$1,134	\$2,037	\$954	\$1,857	\$1,134	\$2,037
Grade H / Leather 5		\$1,143	\$2,127	\$963	\$1,947	\$1,143	\$2,127
Grade J / Leather 6		\$1,152	\$2,217	\$972	\$2,037	\$1,152	\$2,217
Grade K (COM)		\$1,161		\$981		\$1,161	
Grade L / Leather 8		\$1,170	\$3,012	\$990	\$2,832	\$1,170	\$3,012
Grade M (COL)		\$1,179		\$999		\$1,179	
Grade N		\$1,188		\$1,008		\$1,188	
Grade O		\$1,197		\$1,017		\$1,197	
Grade P		\$1,206		\$1,026		\$1,206	
Grade Q		\$1,215		\$1,035		\$1,215	
Grade R		\$1,224		\$1,044		\$1,224	
Grade S		\$1,233		\$1,053		\$1,233	
Grade T		\$1,242		\$1,062		\$1,242	
Grade U		\$1,251		\$1,071		\$1,251	
U+ Formula (See pg.12)		(# above U) x 9 + 1251		(# above U) x 9 + 1071		(# above U) x 9 + 1251	
Riser		9		9		9	
COM (Yards)		2.75		2.75		2.75	
COL (sq. ft.)			57		57		57
Standard Seat Cushion		High Resiliency 40		High Resiliency 40		High Resiliency 40	
Finish Options		Y		N		Y	
Nail-head Trim	Small	Std.	Std.	Std.	Std.	Std.	Std.
	Medium	N/A	N/A	N/A	N/A	N/A	N/A

Stocked Finish Codes

Linen (-L) Mica (-M) Sheer Dove (-S) Tobacco (-T)

Collection		Entrée Dining		Entrée Dining		Entrée Dining	
Name		Empire Short Back Armless Stack Chair with Legs in Stocked Finishes		Empire Short Back Skirted Dining Chair with Legs in Tobacco Finish		Empire Short Back Dining Chair with Legs, Finish Choices with buttons	
SKU Options		Fabric Style	Leather Style	No Casters		Fabric Style	Leather Style
		1240-14-L	L-1240-14-L	1241-05-T		1242-05	L-1242-05
		1240-14-M	L-1240-14-M				
		1240-14-T	L-1240-14-T				
Overall Dimensions	Width	19.5		19.5		19.5	
	Depth	27		27		27	
	Height	38		38		38	
Seat Height		20		20		20	
Seat Depth		19		19		19	
Inside Width		19.5		19.5		19.5	
Wrap, Carton Weight, Cubes		22, 22, 11.57		22, 22, 11.57		22, 22, 21.65	
		Fabric	Leather	Fabric	Fabric	Leather	
Grade D / Leather 1		\$927	\$1,587	\$1,077	\$1,137	\$1,797	
Grade E / Leather 2		\$936	\$1,677	\$1,089	\$1,146	\$1,887	
Grade F / Leather 3		\$945	\$1,767	\$1,101	\$1,155	\$1,977	
Grade G / Leather 4		\$954	\$1,857	\$1,113	\$1,164	\$2,067	
Grade H / Leather 5		\$963	\$1,947	\$1,125	\$1,173	\$2,157	
Grade J / Leather 6		\$972	\$2,037	\$1,137	\$1,182	\$2,247	
Grade K (COM)		\$981		\$1,149	\$1,191		
Grade L / Leather 8		\$990	\$2,832	\$1,161	\$1,200	\$3,042	
Grade M (COL)		\$999		\$1,173	\$1,209		
Grade N		\$1,008		\$1,185	\$1,218		
Grade O		\$1,017		\$1,197	\$1,227		
Grade P		\$1,026		\$1,209	\$1,236		
Grade Q		\$1,035		\$1,221	\$1,245		
Grade R		\$1,044		\$1,233	\$1,254		
Grade S		\$1,053		\$1,245	\$1,263		
Grade T		\$1,062		\$1,257	\$1,272		
Grade U		\$1,071		\$1,269	\$1,281		
U+ Formula (See pg.12)		(# above U) x 9 + 1071		(# above U) x 12 + 1269	(# above U) x 9 + 1281		
Riser		9		12	9		
COM (Yards)		2.75		4.00	2.75		
COL (sq. ft.)			57	N/A		57	
Standard Seat Cushion		High Resiliency 40		High Resiliency 40		High Resiliency 40	
Finish Options		N		N		Y	
Nail-head Trim	Small	Std.	Std.	Std.	Std.	Std.	
	Medium	N/A	N/A	N/A	N/A	N/A	

Stocked Finish Codes

Linen (-L) Mica (-M) Sheer Dove (-S) Tobacco (-T)

Collection		Entrée Dining		Entrée Dining		Entrée Dining	
Name		Empire Short Back Dining Chair		Empire Short Back Armless Stack Chair		Empire Short Back Armless Stack Chair	
SKU Options		with Legs in Stocked Finishes with buttons		with Legs, Finish Choices with buttons		with Legs in Stocked Finishes with buttons	
		Fabric Style	Leather Style	Fabric Style	Leather Style	Fabric Style	Leather Style
		1242-05-L	L-1242-05-L	1242-14	L-1242-14	1242-14-L	L-1242-14-L
		1242-05-M	L-1242-05-M			1242-14-M	L-1242-14-M
		1242-05-S	L-1242-05-S			1242-14-T	L-1242-14-T
		1242-05-T	L-1242-05-T				
Overall Dimensions	Width	19.5		19.5		19.5	
	Depth	27		27		27	
	Height	38		38		38	
Seat Height		20		20		20	
Seat Depth		19		19		19	
Inside Width		19.5		19.5		19.5	
Wrap, Carton Weight, Cubes		22 , 22 , 11.57		22 , 22 , 11.57		22 , 22 , 11.57	
		Fabric	Leather	Fabric	Leather	Fabric	Leather
Grade D / Leather 1		\$957	\$1,617	\$1,137	\$1,797	\$957	\$1,617
Grade E / Leather 2		\$966	\$1,707	\$1,146	\$1,887	\$966	\$1,707
Grade F / Leather 3		\$975	\$1,797	\$1,155	\$1,977	\$975	\$1,797
Grade G / Leather 4		\$984	\$1,887	\$1,164	\$2,067	\$984	\$1,887
Grade H / Leather 5		\$993	\$1,977	\$1,173	\$2,157	\$993	\$1,977
Grade J / Leather 6		\$1,002	\$2,067	\$1,182	\$2,247	\$1,002	\$2,067
Grade K (COM)		\$1,011		\$1,191		\$1,011	
Grade L / Leather 8		\$1,020	\$2,862	\$1,200	\$3,042	\$1,020	\$2,862
Grade M (COL)		\$1,029		\$1,209		\$1,029	
Grade N		\$1,038		\$1,218		\$1,038	
Grade O		\$1,047		\$1,227		\$1,047	
Grade P		\$1,056		\$1,236		\$1,056	
Grade Q		\$1,065		\$1,245		\$1,065	
Grade R		\$1,074		\$1,254		\$1,074	
Grade S		\$1,083		\$1,263		\$1,083	
Grade T		\$1,092		\$1,272		\$1,092	
Grade U		\$1,101		\$1,281		\$1,101	
U+ Formula (See pg.12)		(# above U) x 9 + 1101		(# above U) x 9 + 1281		(# above U) x 9 + 1101	
Riser		9		9		9	
COM (Yards)		2.75		2.75		2.75	
COL (sq. ft.)			57		57		57
Standard Seat Cushion		High Resiliency 40		High Resiliency 40		High Resiliency 40	
Finish Options		N		Y		N	
Nail-head Trim	Small	Std.	Std.	Std.	Std.	Std.	Std.
	Medium	N/A	N/A	N/A	N/A	N/A	N/A

Stocked Finish Codes

Linen (-L) Mica (-M) Sheer Dove (-S) Tobacco (-T)

Collection		Entrée Dining	Entrée Dining		Entrée Dining	
Name		Empire Short Back Skirted Dining Chair with Legs in Tobacco Finish with buttons	Empire Tall Back Dining Chair with Legs, Finish Choices		Empire Tall Back Dining Chair with Legs in Stocked Finishes	
SKU Options		No Casters 1243-05-T	Fabric Style 1244-05	Leather Style L-1244-05	Fabric Style 1244-05-L 1244-05-M 1244-05-S 1244-05-T	Leather Style L-1244-05-L L-1244-05-M L-1244-05-S L-1244-05-T
Overall Dimensions	Width	19.5	19.5		19.5	
	Depth	27	27		27	
	Height	38	42		42	
	Seat Height	20	20		20	
	Seat Depth	19	19		19	
	Inside Width	19.5	19.5		19.5	
Wrap, Carton Weight, Cubes		22 , 22 , 11.57	22 , 22 , 12.79		22 , 22 , 12.79	
		Fabric	Fabric	Leather	Fabric	Leather
Grade D / Leather 1		\$1,107	\$1,107	\$1,767	\$927	\$1,587
Grade E / Leather 2		\$1,119	\$1,116	\$1,857	\$936	\$1,677
Grade F / Leather 3		\$1,131	\$1,125	\$1,947	\$945	\$1,767
Grade G / Leather 4		\$1,143	\$1,134	\$2,037	\$954	\$1,857
Grade H / Leather 5		\$1,155	\$1,143	\$2,127	\$963	\$1,947
Grade J / Leather 6		\$1,167	\$1,152	\$2,217	\$972	\$2,037
Grade K (COM)		\$1,179	\$1,161		\$981	
Grade L / Leather 8		\$1,191	\$1,170	\$3,012	\$990	\$2,832
Grade M (COL)		\$1,203	\$1,179		\$999	
Grade N		\$1,215	\$1,188		\$1,008	
Grade O		\$1,227	\$1,197		\$1,017	
Grade P		\$1,239	\$1,206		\$1,026	
Grade Q		\$1,251	\$1,215		\$1,035	
Grade R		\$1,263	\$1,224		\$1,044	
Grade S		\$1,275	\$1,233		\$1,053	
Grade T		\$1,287	\$1,242		\$1,062	
Grade U		\$1,299	\$1,251		\$1,071	
U+ Formula (See pg.12)		(# above U) x 12 + 1299	(# above U) x 9 + 1251		(# above U) x 9 + 1071	
Riser		12	9		9	
COM (Yards)		4.00	2.75		2.75	
COL (sq. ft.)		N/A		57		57
Standard Seat Cushion		High Resiliency 40		High Resiliency 40		
Finish Options		N		Y		
Nail-head Trim	Small	Std.	Std.	Std.	Std.	Std.
	Medium	N/A	N/A	N/A	N/A	N/A

Stocked Finish Codes

Linen (-L) Mica (-M) Sheer Dove (-S) Tobacco (-T)

Collection		Entrée Dining		Entrée Dining		Entrée Dining	
Name		Empire Tall Back Armless Stack Chair with Legs, Finish Choices		Empire Tall Back Armless Stack Chair with Legs in Stocked Finishes		Empire Tall Back Skirted Dining Chair with Legs in Tobacco Finish	
SKU Options		Fabric Style	Leather Style	Fabric Style	Leather Style	No Casters	
		1244-14	L-1244-14	1244-14-L	L-1244-14-L	1245-05-T	
				1244-14-M	L-1244-14-M		
				1244-14-T	L-1244-14-T		
Overall Dimensions	Width	19.5		19.5		19.5	
	Depth	27		27		27	
	Height	42		42		42	
Seat Height		20		20		20	
Seat Depth		19		19		19	
Inside Width		19.5		19.5		19.5	
Wrap, Carton Weight, Cubes		22 , 22 , 12.79		22 , 22 , 12.79		22 , 22 , 12.79	
		Fabric	Leather	Fabric	Leather	Fabric	
Grade D / Leather 1		\$1,107	\$1,767	\$927	\$1,587	\$1,077	
Grade E / Leather 2		\$1,116	\$1,857	\$936	\$1,677	\$1,089	
Grade F / Leather 3		\$1,125	\$1,947	\$945	\$1,767	\$1,101	
Grade G / Leather 4		\$1,134	\$2,037	\$954	\$1,857	\$1,113	
Grade H / Leather 5		\$1,143	\$2,127	\$963	\$1,947	\$1,125	
Grade J / Leather 6		\$1,152	\$2,217	\$972	\$2,037	\$1,137	
Grade K (COM)		\$1,161		\$981		\$1,149	
Grade L / Leather 8		\$1,170	\$3,012	\$990	\$2,832	\$1,161	
Grade M (COL)		\$1,179		\$999		\$1,173	
Grade N		\$1,188		\$1,008		\$1,185	
Grade O		\$1,197		\$1,017		\$1,197	
Grade P		\$1,206		\$1,026		\$1,209	
Grade Q		\$1,215		\$1,035		\$1,221	
Grade R		\$1,224		\$1,044		\$1,233	
Grade S		\$1,233		\$1,053		\$1,245	
Grade T		\$1,242		\$1,062		\$1,257	
Grade U		\$1,251		\$1,071		\$1,269	
U+ Formula (See pg.12)		(# above U) x 9 + 1251		(# above U) x 9 + 1071		(# above U) x 12 + 1269	
Riser		9		9		12	
COM (Yards)		2.75		2.75		4.00	
COL (sq. ft.)		57		57		N/A	
Standard Seat Cushion		High Resiliency 40		High Resiliency 40		High Resiliency 40	
Finish Options		Y		N		N	
Nail-head Trim	Small	Std.	Std.	Std.	Std.	Std.	
	Medium	N/A	N/A	N/A	N/A	N/A	

Stocked Finish Codes

Linen (-L) Mica (-M) Sheer Dove (-S) Tobacco (-T)

Collection		Entrée Dining		Entrée Dining		Entrée Dining	
Name		Empire Tall Back Dining Chair with Legs, Finish Choices with buttons		Empire Tall Back Dining Chair with Legs in Stocked Finishes with buttons		Empire Tall Back Armless Stack Chair with Legs, Finish Choices with buttons	
SKU Options		Fabric Style	Leather Style	Fabric Style	Leather Style	Fabric Style	Leather Style
		1246-05	L-1246-05	1246-05-L 1246-05-M 1246-05-S 1246-05-T	L-1246-05-L L-1246-05-M L-1246-05-S L-1246-05-T	1246-14	L-1246-14
Overall Dimensions	Width	19.5		19.5		19.5	
	Depth	27		27		27	
	Height	42		42		42	
Seat Height		20		20		20	
Seat Depth		19		19		19	
Inside Width		19.5		19.5		19.5	
Wrap, Carton Weight, Cubes		22 , 22 , 12.79		22 , 22 , 12.79		22 , 22 , 12.79	
		Fabric	Leather	Fabric	Leather	Fabric	Leather
Grade D / Leather 1		\$1,137	\$1,797	\$957	\$1,617	\$1,137	\$1,797
Grade E / Leather 2		\$1,146	\$1,887	\$966	\$1,707	\$1,146	\$1,887
Grade F / Leather 3		\$1,155	\$1,977	\$975	\$1,797	\$1,155	\$1,977
Grade G / Leather 4		\$1,164	\$2,067	\$984	\$1,887	\$1,164	\$2,067
Grade H / Leather 5		\$1,173	\$2,157	\$993	\$1,977	\$1,173	\$2,157
Grade J / Leather 6		\$1,182	\$2,247	\$1,002	\$2,067	\$1,182	\$2,247
Grade K (COM)		\$1,191		\$1,011		\$1,191	
Grade L / Leather 8		\$1,200	\$3,042	\$1,020	\$2,862	\$1,200	\$3,042
Grade M (COL)		\$1,209		\$1,029		\$1,209	
Grade N		\$1,218		\$1,038		\$1,218	
Grade O		\$1,227		\$1,047		\$1,227	
Grade P		\$1,236		\$1,056		\$1,236	
Grade Q		\$1,245		\$1,065		\$1,245	
Grade R		\$1,254		\$1,074		\$1,254	
Grade S		\$1,263		\$1,083		\$1,263	
Grade T		\$1,272		\$1,092		\$1,272	
Grade U		\$1,281		\$1,101		\$1,281	
U+ Formula (See pg.12)		(# above U) x 9 + 1281		(# above U) x 9 + 1101		(# above U) x 9 + 1281	
Riser		9		9		9	
COM (Yards)		2.75		2.75		2.75	
COL (sq. ft.)			57		57		57
Standard Seat Cushion		High Resiliency 40		High Resiliency 40		High Resiliency 40	
Finish Options		Y		N		Y	
Nail-head Trim	Small	Std.	Std.	Std.	Std.	Std.	Std.
	Medium	N/A	N/A	N/A	N/A	N/A	N/A

Stocked Finish Codes

Linen (-L)

Mica (-M)

Sheer Dove (-S)

Tobacco (-T)

Collection		Entrée Dining		Entrée Dining
Name	Empire Tall Back		Empire Tall Back	
	Armless Stack Chair		Skirted Dining Chair	
	with Legs in Stocked Finishes with buttons		with Legs in Tobacco Finish with buttons	
SKU Options	Fabric Style	Leather Style	No Casters	
	1246-14-L	L-1246-14-L	1247-05-T	
	1246-14-M	L-1246-14-M		
	1246-14-T	L-1246-14-T		
Overall Dimensions	Width	19.5		19.5
	Depth	27		27
	Height	42		42
Seat Height		20		20
Seat Depth		19		19
Inside Width		19.5		19.5
Wrap, Carton Weight, Cubes		22 , 22 , 12.79		22 , 22 , 12.79
		Fabric	Leather	Fabric
Grade D / Leather 1		\$957	\$1,617	\$1,107
Grade E / Leather 2		\$966	\$1,707	\$1,119
Grade F / Leather 3		\$975	\$1,797	\$1,131
Grade G / Leather 4		\$984	\$1,887	\$1,143
Grade H / Leather 5		\$993	\$1,977	\$1,155
Grade J / Leather 6		\$1,002	\$2,067	\$1,167
Grade K (COM)		\$1,011		\$1,179
Grade L / Leather 8		\$1,020	\$2,862	\$1,191
Grade M (COL)		\$1,029		\$1,203
Grade N		\$1,038		\$1,215
Grade O		\$1,047		\$1,227
Grade P		\$1,056		\$1,239
Grade Q		\$1,065		\$1,251
Grade R		\$1,074		\$1,263
Grade S		\$1,083		\$1,275
Grade T		\$1,092		\$1,287
Grade U		\$1,101		\$1,299
U+ Formula (See pg.12)		(# above U) x 9 + 1101		(# above U) x 12 + 1299
Riser		9		12
COM (Yards)		2.75		4.00
COL (sq. ft.)			57	N/A
Standard Seat Cushion		High Resiliency 40		High Resiliency 40
Finish Options		N		N
Nail-head Trim	Small	Std.	Std.	Std.
	Medium	N/A	N/A	N/A

NEW | Quinn Banquette Series;

- Developed for Residential and Commercial Spaces
- Contract Grade Construction with Stretchers
- Designed to Pair with The Entrée Dining Tall Straight Back Chair
- Available in Stocked Finishes: Mica, Linen & Tobacco
- Also Available in 40+ Finishes



1270-36 Armless Banquette, 1270-29 Corner Chair Banquette, 1270-48 Armless Banquette, Tapered Legs, Mica Finish shown

1270 Quinn Plain Back Banquette, Tapered Leg Optional small nailhead trim is available on base



1270-29 w27 d27 h41.25 Corner Chair Banquette	1270-36 w36.75 d27 h41.25 Armless Banquette	1270-48 w48.75 d27 h41.25 Armless Banquette	1270-60 w60.75 d27 h41.25 Armless Banquette	1270-72 w72.75 d27 h41.25 Armless Banquette
1270-29 → 1270-29-M Mica 1270-29-L Linen 1270-29-T Tobacco	1270-36 → 1270-36-M Mica 1270-36-L Linen 1270-36-T Tobacco	1270-48 → 1270-48-M Mica 1270-48-L Linen 1270-48-T Tobacco	1270-60 → 1270-60-M Mica 1270-60-L Linen 1270-60-T Tobacco	1270-72 → 1270-72-M Mica 1270-72-L Linen 1270-72-T Tobacco



1271 Quinn Plain Back Banquette with Skirt Legs are standard in Tobacco finish

1271-29 w27 d27 h41.25 Corner Chair Banquette	1271-36 w36.75 d27 h41.25 Armless Banquette	1271-48 w48.75 d27 h41.25 Armless Banquette	1271-60 w60.75 d27 h41.25 Armless Banquette	1271-72 w72.75 d27 h41.25 Armless Banquette
1271-29-T Tobacco	1271-36-T Tobacco	1271-48-T Tobacco	1271-60-T Tobacco	1271-72-T Tobacco



1272-60 Armless Banquette, 1272-29 Corner Chair Banquette, 1272-72 Armless Banquette, Tapered Legs, Mica Finish

1272 Quinn Button Back Banquette, Tapered Leg Optional small nailhead trim is available on base



1272-29 w27 d27 h41.25 Corner Chair Banquette	1272-36 w36.75 d27 h41.25 Armless Banquette	1272-48 w48.75 d27 h41.25 Armless Banquette	1272-60 w60.75 d27 h41.25 Armless Banquette	1272-72 w72.75 d27 h41.25 Armless Banquette
1272-29 → 1272-29-M Mica 1272-29-L Linen 1272-29-T Tobacco	1272-36 → 1272-36-M Mica 1272-36-L Linen 1272-36-T Tobacco	1272-48 → 1272-48-M Mica 1272-48-L Linen 1272-48-T Tobacco	1272-60 → 1272-60-M Mica 1272-60-L Linen 1272-60-T Tobacco	1272-72 → 1272-72-M Mica 1272-72-L Linen 1272-72-T Tobacco



1273 Quinn Button Back Banquette with Skirt Legs are standard in Tobacco finish

1273-29 w27 d27 h41.25 Corner Chair Banquette	1273-36 w36.75 d27 h41.25 Armless Banquette	1273-48 w48.75 d27 h41.25 Armless Banquette	1273-60 w60.75 d27 h41.25 Armless Banquette	1273-72 w72.75 d27 h41.25 Armless Banquette
1273-29-T Tobacco	1273-36-T Tobacco	1273-48-T Tobacco	1273-60-T Tobacco	1273-72-T Tobacco

Stocked Finish Codes

Linen (-L) Mica (-M) Tobacco (-T)

Collection		Entrée Banquette		Entrée Banquette		Entrée Banquette	
Name		Corner Chair Banquette Straight Back		Armless Banquette 36" Straight Back		Armless Banquette 48" Straight Back	
SKU Options		Finish Options	Stocked Finishes	Finish Options	Stocked Finishes	Finish Options	Stocked Finishes
		1270-29	1270-29-L 1270-29-M 1270-29-T	1270-36	1270-36-L 1270-36-M 1270-36-T	1270-48	1270-48-L 1270-48-M 1270-48-T
Overall Dimensions	Width	27		36.75		48.75	
	Depth	27		27		27	
	Height	41.25		41.25		41.25	
Seat Height		20		20		20	
Seat Depth		18		18		18	
Inside Width		18		36.75		48.75	
Wrap, Carton Weight, Cubes		30, 30, 17.4		30, 30, 23.68		45, 45, 31.42	
Grade D		\$1,377	\$1,197	\$1,347	\$1,167	\$1,647	\$1,497
Grade E		\$1,392	\$1,212	\$1,362	\$1,182	\$1,665	\$1,515
Grade F		\$1,407	\$1,227	\$1,377	\$1,197	\$1,683	\$1,533
Grade G		\$1,422	\$1,242	\$1,392	\$1,212	\$1,701	\$1,551
Grade H		\$1,437	\$1,257	\$1,407	\$1,227	\$1,719	\$1,569
Grade J		\$1,452	\$1,272	\$1,422	\$1,242	\$1,737	\$1,587
Grade K (COM)		\$1,467	\$1,287	\$1,437	\$1,257	\$1,755	\$1,605
Grade L		\$1,482	\$1,302	\$1,452	\$1,272	\$1,773	\$1,623
Grade M		\$1,497	\$1,317	\$1,467	\$1,287	\$1,791	\$1,641
Grade N		\$1,512	\$1,332	\$1,482	\$1,302	\$1,809	\$1,659
Grade O		\$1,527	\$1,347	\$1,497	\$1,317	\$1,827	\$1,677
Grade P		\$1,542	\$1,362	\$1,512	\$1,332	\$1,845	\$1,695
Grade Q		\$1,557	\$1,377	\$1,527	\$1,347	\$1,863	\$1,713
Grade R		\$1,572	\$1,392	\$1,542	\$1,362	\$1,881	\$1,731
Grade S		\$1,587	\$1,407	\$1,557	\$1,377	\$1,899	\$1,749
Grade T		\$1,602	\$1,422	\$1,572	\$1,392	\$1,917	\$1,767
Grade U		\$1,617	\$1,437	\$1,587	\$1,407	\$1,935	\$1,785
U+ Formula (See pg.12)		(# above U) x 15 + 1617	(# above U) x 15 + 1437	(# above U) x 15 + 1587	(# above U) x 15 + 1407	(# above U) x 18 + 1935	(# above U) x 18 + 1785
Riser		15		15		18	
COM (Yards)		5.00		4.75		6.00	
Standard Seat Cushion		High Resiliency 40		High Resiliency 40		High Resiliency 40	
Finish Options		Y	N	Y	N	Y	N
Nail-head Trim	Small	45	45	45	45	45	45
	Medium	N/A	N/A	N/A	N/A	N/A	N/A

Stocked Finish Codes

Linen (-L) Mica (-M) Tobacco (-T)

Collection		Entrée Banquette		Entrée Banquette		Entrée Banquette
Name		Armless Banquette 60" Straight Back		Armless Banquette 72" Straight Back		Skirted Corner Chair Banquette with Legs in Tobacco Finish
SKU Options		Finish Options	Stocked Finishes	Finish Options	Stocked Finishes	Stocked in Tobacco
		1270-60	1270-60-L 1270-60-M 1270-60-T	1270-72	1270-72-L 1270-72-M 1270-72-T	1271-29-T
Overall Dimensions	Width	60.75		72.75		27
	Depth	27		27		27
	Height	41.25		41.25		41.25
Seat Height		20		20		20
Seat Depth		18		18		18
Inside Width		60.75		72.75		18
Wrap, Carton Weight, Cubes		56 , 56 , 39.15		60 , 60 , 46.88		30 , 30 , 17.4
Grade D		\$1,887	\$1,647	\$2,157	\$1,947	\$1,377
Grade E		\$1,908	\$1,668	\$2,181	\$1,971	\$1,395
Grade F		\$1,929	\$1,689	\$2,205	\$1,995	\$1,413
Grade G		\$1,950	\$1,710	\$2,229	\$2,019	\$1,431
Grade H		\$1,971	\$1,731	\$2,253	\$2,043	\$1,449
Grade J		\$1,992	\$1,752	\$2,277	\$2,067	\$1,467
Grade K (COM)		\$2,013	\$1,773	\$2,301	\$2,091	\$1,485
Grade L		\$2,034	\$1,794	\$2,325	\$2,115	\$1,503
Grade M		\$2,055	\$1,815	\$2,349	\$2,139	\$1,521
Grade N		\$2,076	\$1,836	\$2,373	\$2,163	\$1,539
Grade O		\$2,097	\$1,857	\$2,397	\$2,187	\$1,557
Grade P		\$2,118	\$1,878	\$2,421	\$2,211	\$1,575
Grade Q		\$2,139	\$1,899	\$2,445	\$2,235	\$1,593
Grade R		\$2,160	\$1,920	\$2,469	\$2,259	\$1,611
Grade S		\$2,181	\$1,941	\$2,493	\$2,283	\$1,629
Grade T		\$2,202	\$1,962	\$2,517	\$2,307	\$1,647
Grade U		\$2,223	\$1,983	\$2,541	\$2,331	\$1,665
U+ Formula (See pg.12)		(# above U) x 21 + 2223	(# above U) x 21 + 1983	(# above U) x 24 + 2541	(# above U) x 24 + 2331	(# above U) x 18 + 1665
Riser		21		24		18
COM (Yards)		7.00		8.00		5.50
Standard Seat Cushion		High Resiliency 40		High Resiliency 40		High Resiliency 40
Finish Options		Y	N	Y	N	N
Nail-head Trim	Small	N/A	N/A	N/A	N/A	N/A
	Medium	N/A	N/A	N/A	N/A	N/A

Stocked Finish Codes

Linen (-L) Mica (-M) Tobacco (-T)

Collection		Entrée Banquette	Entrée Banquette	Entrée Banquette
Name		Skirted Armless Banquette 36" with Legs in Tobacco Finish	Skirted Armless Banquette 48" with Legs in Tobacco Finish	Skirted Armless Banquette 60" with Legs in Tobacco Finish
	SKU Options	Stocked in Tobacco 1271-36-T	Stocked in Tobacco 1271-48-T	Stocked in Tobacco 1271-60-T
Overall Dimensions	Width	36.75	48.75	60.75
	Depth	27	27	27
	Height	41.25	41.25	41.25
	Seat Height	20	20	20
	Seat Depth	18	18	18
	Inside Width	36.75	48.75	60.75
Wrap, Carton Weight, Cubes		30 , 30 , 23.68	45 , 45 , 31.42	56 , 56 , 39.15
	Grade D	\$1,347	\$1,647	\$1,887
	Grade E	\$1,365	\$1,668	\$1,911
	Grade F	\$1,383	\$1,689	\$1,935
	Grade G	\$1,401	\$1,710	\$1,959
	Grade H	\$1,419	\$1,731	\$1,983
	Grade J	\$1,437	\$1,752	\$2,007
	Grade K (COM)	\$1,455	\$1,773	\$2,031
	Grade L	\$1,473	\$1,794	\$2,055
	Grade M	\$1,491	\$1,815	\$2,079
	Grade N	\$1,509	\$1,836	\$2,103
	Grade O	\$1,527	\$1,857	\$2,127
	Grade P	\$1,545	\$1,878	\$2,151
	Grade Q	\$1,563	\$1,899	\$2,175
	Grade R	\$1,581	\$1,920	\$2,199
	Grade S	\$1,599	\$1,941	\$2,223
	Grade T	\$1,617	\$1,962	\$2,247
	Grade U	\$1,635	\$1,983	\$2,271
	U+ Formula (See pg.12)	(# above U) x 18 + 1635	(# above U) x 21 + 1983	(# above U) x 24 + 2271
	Riser	18	21	24
	COM (Yards)	5.00	6.50	7.50
	Standard Seat Cushion	High Resiliency 40	High Resiliency 40	High Resiliency 40
	Finish Options	N	N	N
Nail-head Trim	Small	N/A	N/A	N/A
	Medium	N/A	N/A	N/A

Stocked Finish Codes

Linen (-L) Mica (-M) Tobacco (-T)

Collection		Entrée Banquette	Entrée Banquette		Entrée Banquette	
Name		Skirted Armless Banquette 72" with Legs in Tobacco Finish	Corner Chair Banquette Straight Back		Armless Banquette 36" Straight Back	
SKU Options		Stocked in Tobacco 1271-72-T	Finish Options 1272-29	Stocked Finishes 1272-29-L 1272-29-M 1272-29-T	Finish Options 1272-36	Stocked Finishes 1272-36-L 1272-36-M 1272-36-T
Overall Dimensions	Width	72.75	27		36.75	
	Depth	27	27		27	
	Height	41.25	41.25		41.25	
Seat Height		20	20		20	
Seat Depth		18	18		18	
Inside Width		72.75	18		36.75	
Wrap, Carton Weight, Cubes		60 , 60 , 46.88	30 , 30 , 17.4		30 , 30 , 23.68	
Grade D		\$2,157	\$1,377	\$1,197	\$1,347	\$1,167
Grade E		\$2,184	\$1,392	\$1,212	\$1,362	\$1,182
Grade F		\$2,211	\$1,407	\$1,227	\$1,377	\$1,197
Grade G		\$2,238	\$1,422	\$1,242	\$1,392	\$1,212
Grade H		\$2,265	\$1,437	\$1,257	\$1,407	\$1,227
Grade J		\$2,292	\$1,452	\$1,272	\$1,422	\$1,242
Grade K (COM)		\$2,319	\$1,467	\$1,287	\$1,437	\$1,257
Grade L		\$2,346	\$1,482	\$1,302	\$1,452	\$1,272
Grade M		\$2,373	\$1,497	\$1,317	\$1,467	\$1,287
Grade N		\$2,400	\$1,512	\$1,332	\$1,482	\$1,302
Grade O		\$2,427	\$1,527	\$1,347	\$1,497	\$1,317
Grade P		\$2,454	\$1,542	\$1,362	\$1,512	\$1,332
Grade Q		\$2,481	\$1,557	\$1,377	\$1,527	\$1,347
Grade R		\$2,508	\$1,572	\$1,392	\$1,542	\$1,362
Grade S		\$2,535	\$1,587	\$1,407	\$1,557	\$1,377
Grade T		\$2,562	\$1,602	\$1,422	\$1,572	\$1,392
Grade U		\$2,589	\$1,617	\$1,437	\$1,587	\$1,407
U+ Formula (See pg.12)		(# above U) x 27 + 2589	(# above U) x 15 + 1617	(# above U) x 15 + 1437	(# above U) x 15 + 1587	(# above U) x 15 + 1407
Riser		27	15		15	
COM (Yards)		8.25	5.00		4.75	
Standard Seat Cushion		High Resiliency 40	High Resiliency 40		High Resiliency 40	
Finish Options		N	Y	N	Y	N
Nail-head Trim	Small	N/A	45	45	45	45
	Medium	N/A	N/A	N/A	N/A	N/A

Stocked Finish Codes

Linen (-L) Mica (-M) Tobacco (-T)

Collection		Entrée Banquette		Entrée Banquette		Entrée Banquette	
Name		Armless Banquette 48" Straight Back		Armless Banquette 60" Straight Back		Armless Banquette 72" Straight Back	
SKU Options		Finish Options	Stocked Finishes	Finish Options	Stocked Finishes	Finish Options	Stocked Finishes
		1272-48	1272-48-L 1272-48-M 1272-48-T	1272-60	1272-60-L 1272-60-M 1272-60-T	1272-72	1272-72-L 1272-72-M 1272-72-T
Overall Dimensions	Width	48.75		60.75		72.75	
	Depth	27		27		27	
	Height	41.25		41.25		41.25	
Seat Height		20		20		20	
Seat Depth		18		18		18	
Inside Width		48.75		60.75		72.75	
Wrap, Carton Weight, Cubes		45 , 45 , 31.42		56 , 56 , 39.15		60 , 60 , 46.88	
Grade D		\$1,647	\$1,497	\$1,887	\$1,647	\$2,157	\$1,947
Grade E		\$1,665	\$1,515	\$1,908	\$1,668	\$2,181	\$1,971
Grade F		\$1,683	\$1,533	\$1,929	\$1,689	\$2,205	\$1,995
Grade G		\$1,701	\$1,551	\$1,950	\$1,710	\$2,229	\$2,019
Grade H		\$1,719	\$1,569	\$1,971	\$1,731	\$2,253	\$2,043
Grade J		\$1,737	\$1,587	\$1,992	\$1,752	\$2,277	\$2,067
Grade K (COM)		\$1,755	\$1,605	\$2,013	\$1,773	\$2,301	\$2,091
Grade L		\$1,773	\$1,623	\$2,034	\$1,794	\$2,325	\$2,115
Grade M		\$1,791	\$1,641	\$2,055	\$1,815	\$2,349	\$2,139
Grade N		\$1,809	\$1,659	\$2,076	\$1,836	\$2,373	\$2,163
Grade O		\$1,827	\$1,677	\$2,097	\$1,857	\$2,397	\$2,187
Grade P		\$1,845	\$1,695	\$2,118	\$1,878	\$2,421	\$2,211
Grade Q		\$1,863	\$1,713	\$2,139	\$1,899	\$2,445	\$2,235
Grade R		\$1,881	\$1,731	\$2,160	\$1,920	\$2,469	\$2,259
Grade S		\$1,899	\$1,749	\$2,181	\$1,941	\$2,493	\$2,283
Grade T		\$1,917	\$1,767	\$2,202	\$1,962	\$2,517	\$2,307
Grade U		\$1,935	\$1,785	\$2,223	\$1,983	\$2,541	\$2,331
U+ Formula (See pg.12)		(# above U) x 18 + 1935	(# above U) x 18 + 1785	(# above U) x 21 + 2223	(# above U) x 21 + 1983	(# above U) x 24 + 2541	(# above U) x 24 + 2331
Riser		18		21		24	
COM (Yards)		6.00		7.00		8.00	
Standard Seat Cushion		High Resiliency 40		High Resiliency 40		High Resiliency 40	
Finish Options		Y	N	Y	N	Y	N
Nail-head Trim	Small	45	45	N/A	N/A	N/A	N/A
	Medium	N/A	N/A	N/A	N/A	N/A	N/A

Stocked Finish Codes

Linen (-L) Mica (-M) Tobacco (-T)

Collection		Entrée Banquette	Entrée Banquette	Entrée Banquette
Name		Skirted Corner Chair Banquette	Skirted Armless Banquette 36"	Skirted Armless Banquette 48"
		with Legs in Tobacco Finish with buttons	with Legs in Tobacco Finish with buttons	with Legs in Tobacco Finish with buttons
SKU Options		Stocked in Tobacco	Stocked in Tobacco	Stocked in Tobacco
		1273-29-T	1273-36-T	1273-48-T
Overall Dimensions	Width	27	36.75	48.75
	Depth	27	27	27
	Height	41.25	41.25	41.25
	Seat Height	20	20	20
	Seat Depth	18	18	18
	Inside Width	18	36.75	48.75
Wrap, Carton Weight, Cubes		30 , 30 , 17.4	30 , 30 , 23.68	45 , 45 , 31.42
	Grade D	\$1,377	\$1,347	\$1,647
	Grade E	\$1,395	\$1,365	\$1,668
	Grade F	\$1,413	\$1,383	\$1,689
	Grade G	\$1,431	\$1,401	\$1,710
	Grade H	\$1,449	\$1,419	\$1,731
	Grade J	\$1,467	\$1,437	\$1,752
	Grade K (COM)	\$1,485	\$1,455	\$1,773
	Grade L	\$1,503	\$1,473	\$1,794
	Grade M	\$1,521	\$1,491	\$1,815
	Grade N	\$1,539	\$1,509	\$1,836
	Grade O	\$1,557	\$1,527	\$1,857
	Grade P	\$1,575	\$1,545	\$1,878
	Grade Q	\$1,593	\$1,563	\$1,899
	Grade R	\$1,611	\$1,581	\$1,920
	Grade S	\$1,629	\$1,599	\$1,941
	Grade T	\$1,647	\$1,617	\$1,962
	Grade U	\$1,665	\$1,635	\$1,983
	U+ Formula (See pg.12)	(# above U) x 18 + 1665	(# above U) x 18 + 1635	(# above U) x 21 + 1983
	Riser	18	18	21
	COM (Yards)	5.50	5.00	6.50
	Standard Seat Cushion	High Resiliency 40	High Resiliency 40	High Resiliency 40
	Finish Options	N	N	N
Nail-head Trim	Small	N/A	N/A	N/A
	Medium	N/A	N/A	N/A

Stocked Finish Codes

Linen (-L) Mica (-M) Tobacco (-T)

Collection		Entrée Banquette	Entrée Banquette
Name		Skirted Armless Banquette 60"	Skirted Armless Banquette 72"
		with Legs in Tobacco Finish with buttons	with Legs in Tobacco Finish with buttons
SKU Options		Stocked in Tobacco	Stocked in Tobacco
		1273-60-T	1273-72-T
Overall Dimensions	Width	60.75	72.75
	Depth	27	27
	Height	41.25	41.25
	Seat Height	20	20
	Seat Depth	18	18
	Inside Width	60.75	72.75
Wrap, Carton Weight, Cubes		56 , 56 , 39.15	60 , 60 , 46.88
	Grade D	\$1,887	\$2,157
	Grade E	\$1,911	\$2,184
	Grade F	\$1,935	\$2,211
	Grade G	\$1,959	\$2,238
	Grade H	\$1,983	\$2,265
	Grade J	\$2,007	\$2,292
	Grade K (COM)	\$2,031	\$2,319
	Grade L	\$2,055	\$2,346
	Grade M	\$2,079	\$2,373
	Grade N	\$2,103	\$2,400
	Grade O	\$2,127	\$2,427
	Grade P	\$2,151	\$2,454
	Grade Q	\$2,175	\$2,481
	Grade R	\$2,199	\$2,508
	Grade S	\$2,223	\$2,535
	Grade T	\$2,247	\$2,562
	Grade U	\$2,271	\$2,589
	U+ Formula (See pg.12)	(# above U) x 24 + 2271	(# above U) x 27 + 2589
	Riser	24	27
	COM (Yards)	7.75	8.75
	Standard Seat Cushion	High Resiliency 40	High Resiliency 40
	Finish Options	N	N
Nail-head Trim	Small	N/A	N/A
	Medium	N/A	N/A

1300 Series Dining Chairs, Bar & Counter Stools

Stocked Finish Codes

Linen (-L) Mica (-M) Sheer Dove (-S) Tobacco (-T)

Name		Side Chair Silas		Armless Bar Stool Silas		Armless Counter Stool Silas		Side Chair Nova	
		Finish Options	Stocked Finishes	Finish Options	Stocked Finishes	Finish Options	Stocked Finishes	Finish Options	Stocked Finishes
Fabric SKU Options		1300-05	1300-05-L 1300-05-M 1300-05-S 1300-05-T	1300-07	1300-07-L 1300-07-M 1300-07-S 1300-07-T	1300-C7	1300-C7-L 1300-C7-M 1300-C7-S 1300-C7-T	1301-05	1301-05-L 1301-05-M 1301-05-S 1301-05-T
Overall Dimensions	Width	19.25		19.25		19.25		19.25	
	Depth	21		21		21		21	
	Height	36		42.5		36.5		36	
	Seat Height	19.5		29.75		23.75		19.5	
	Seat Depth	16		16		16		16	
	Inside Width	19.25		19.25		19.25		19.25	
Wrap, Carton Weight, Cubes		30, 30, 8.42		30, 30, 9.94		30, 30, 8.53		30, 30, 8.42	
		Finish Options	Stocked Finishes	Finish Options	Stocked Finishes	Finish Options	Stocked Finishes	Finish Options	Stocked Finishes
Grade D		\$957	\$867	\$987	\$897	\$987	\$897	\$957	\$867
Grade E		\$963	\$873	\$993	\$903	\$993	\$903	\$963	\$873
Grade F		\$969	\$879	\$999	\$909	\$999	\$909	\$969	\$879
Grade G		\$975	\$885	\$1,005	\$915	\$1,005	\$915	\$975	\$885
Grade H		\$981	\$891	\$1,011	\$921	\$1,011	\$921	\$981	\$891
Grade J		\$987	\$897	\$1,017	\$927	\$1,017	\$927	\$987	\$897
Grade K (COM)		\$993	\$903	\$1,023	\$933	\$1,023	\$933	\$993	\$903
Grade L		\$999	\$909	\$1,029	\$939	\$1,029	\$939	\$999	\$909
Grade M (COL)		\$1,005	\$915	\$1,035	\$945	\$1,035	\$945	\$1,005	\$915
Grade N		\$1,011	\$921	\$1,041	\$951	\$1,041	\$951	\$1,011	\$921
Grade O		\$1,017	\$927	\$1,047	\$957	\$1,047	\$957	\$1,017	\$927
Grade P		\$1,023	\$933	\$1,053	\$963	\$1,053	\$963	\$1,023	\$933
Grade Q		\$1,029	\$939	\$1,059	\$969	\$1,059	\$969	\$1,029	\$939
Grade R		\$1,035	\$945	\$1,065	\$975	\$1,065	\$975	\$1,035	\$945
Grade S		\$1,041	\$951	\$1,071	\$981	\$1,071	\$981	\$1,041	\$951
Grade T		\$1,047	\$957	\$1,077	\$987	\$1,077	\$987	\$1,047	\$957
Grade U		\$1,053	\$963	\$1,083	\$993	\$1,083	\$993	\$1,053	\$963
U+ Formula (See pg.12)		(# above U) x 6 + 1053	(# above U) x 6 + 963	(# above U) x 6 + 1083	(# above U) x 6 + 993	(# above U) x 6 + 1083	(# above U) x 6 + 993	(# above U) x 6 + 1053	(# above U) x 6 + 963
Riser		6		6		6		6	
COM (Yards)		1.75		1.75		1.75		1.75	
COL (sq. ft.)		34		34		34		34	
Leather SKU Pricing		Leather		Leather		Leather		Leather	
		Finish Options	Stocked Finishes	Finish Options	Stocked Finishes	Finish Options	Stocked Finishes	Finish Options	Stocked Finishes
		L-1300-05	L-1300-05-L L-1300-05-M L-1300-05-S L-1300-05-T	L-1300-07	L-1300-07-L L-1300-07-M L-1300-07-S L-1300-07-T	L-1300-C7	L-1300-C7-L L-1300-C7-M L-1300-C7-S L-1300-C7-T	L-1301-05	L-1301-05-L L-1301-05-M L-1301-05-S L-1301-05-T
Leather 1		\$1,377	\$1,167	\$1,407	\$1,197	\$1,407	\$1,197	\$1,377	\$1,167
Leather 2		\$1,437	\$1,227	\$1,467	\$1,257	\$1,467	\$1,257	\$1,437	\$1,227
Leather 3		\$1,497	\$1,287	\$1,527	\$1,317	\$1,527	\$1,317	\$1,497	\$1,287
Leather 4		\$1,557	\$1,347	\$1,587	\$1,377	\$1,587	\$1,377	\$1,557	\$1,347
Leather 5		\$1,617	\$1,407	\$1,647	\$1,437	\$1,647	\$1,437	\$1,617	\$1,407
Leather 6		\$1,677	\$1,467	\$1,707	\$1,497	\$1,707	\$1,497	\$1,677	\$1,467
Leather 8		\$2,142	\$1,932	\$2,172	\$1,962	\$2,172	\$1,962	\$2,142	\$1,932
Standard Seat Cushion		High Resiliency 40		High Resiliency 40		High Resiliency 40		High Resiliency 40	
Finish Options		Y	N	Y	N	Y	N	Y	N
Nail-head Trim	Small	45	45	45	45	45	45	45	45
	Medium	N/A	N/A	N/A	N/A	N/A	N/A	N/A	N/A

1300 Series Dining Chairs, Bar & Counter Stools

Stocked Finish Codes

Linen (-L) Mica (-M) Sheer Dove (-S) Tobacco (-T)

Name		Armless Bar Stool Nova		Armless Counter Stool Nova		Side Chair Arie		Armless Bar Stool Arie	
		Finish Options	Stocked Finishes	Finish Options	Stocked Finishes	Finish Options	Stocked Finishes	Finish Options	Stocked Finishes
Fabric SKU Options		1301-07	1301-07-L 1301-07-M 1301-07-S 1301-07-T	1301-C7	1301-C7-L 1301-C7-M 1301-C7-S 1301-C7-T	1302-05	1302-05-L 1302-05-M 1302-05-S 1302-05-T	1302-07	1302-07-L 1302-07-M 1302-07-S 1302-07-T
Overall Dimensions	Width	19.25		19.25		19.25		19.25	
	Depth	21		21		21		21	
	Height	42.5		36.5		36		42.5	
	Seat Height	29.75		23.75		19.5		29.5	
	Seat Depth	16		16		16		16	
	Inside Width	19.25		19.25		19.25		19.25	
Wrap, Carton Weight, Cubes		30, 30, 9.94		30, 30, 8.53		30, 30, 8.42		30, 30, 9.94	
		Finish Options	Stocked Finishes	Finish Options	Stocked Finishes	Finish Options	Stocked Finishes	Finish Options	Stocked Finishes
Grade D		\$987	\$897	\$987	\$897	\$957	\$867	\$987	\$897
Grade E		\$993	\$903	\$993	\$903	\$963	\$873	\$993	\$903
Grade F		\$999	\$909	\$999	\$909	\$969	\$879	\$999	\$909
Grade G		\$1,005	\$915	\$1,005	\$915	\$975	\$885	\$1,005	\$915
Grade H		\$1,011	\$921	\$1,011	\$921	\$981	\$891	\$1,011	\$921
Grade J		\$1,017	\$927	\$1,017	\$927	\$987	\$897	\$1,017	\$927
Grade K (COM)		\$1,023	\$933	\$1,023	\$933	\$993	\$903	\$1,023	\$933
Grade L		\$1,029	\$939	\$1,029	\$939	\$999	\$909	\$1,029	\$939
Grade M (COL)		\$1,035	\$945	\$1,035	\$945	\$1,005	\$915	\$1,035	\$945
Grade N		\$1,041	\$951	\$1,041	\$951	\$1,011	\$921	\$1,041	\$951
Grade O		\$1,047	\$957	\$1,047	\$957	\$1,017	\$927	\$1,047	\$957
Grade P		\$1,053	\$963	\$1,053	\$963	\$1,023	\$933	\$1,053	\$963
Grade Q		\$1,059	\$969	\$1,059	\$969	\$1,029	\$939	\$1,059	\$969
Grade R		\$1,065	\$975	\$1,065	\$975	\$1,035	\$945	\$1,065	\$975
Grade S		\$1,071	\$981	\$1,071	\$981	\$1,041	\$951	\$1,071	\$981
Grade T		\$1,077	\$987	\$1,077	\$987	\$1,047	\$957	\$1,077	\$987
Grade U		\$1,083	\$993	\$1,083	\$993	\$1,053	\$963	\$1,083	\$993
U+ Formula (See pg.12)		(# above U) x 6 + 1083	(# above U) x 6 + 993	(# above U) x 6 + 1083	(# above U) x 6 + 993	(# above U) x 6 + 1053	(# above U) x 6 + 963	(# above U) x 6 + 1083	(# above U) x 6 + 993
Riser		6		6		6		6	
COM (Yards)		1.75		1.75		2.00		2.00	
COL (sq. ft.)		34		34		34		34	
Leather SKU Pricing		Leather		Leather		Leather		Leather	
		Finish Options	Stocked Finishes	Finish Options	Stocked Finishes	Finish Options	Stocked Finishes	Finish Options	Stocked Finishes
		L-1301-07	L-1301-07-L L-1301-07-M L-1301-07-S L-1301-07-T	L-1301-C7	L-1301-C7-L L-1301-C7-M L-1301-C7-S L-1301-C7-T	L-1302-05	L-1302-05-L L-1302-05-M L-1302-05-S L-1302-05-T	L-1302-07	L-1302-07-L L-1302-07-M L-1302-07-S L-1302-07-T
Leather 1		\$1,407	\$1,197	\$1,407	\$1,197	\$1,377	\$1,167	\$1,407	\$1,197
Leather 2		\$1,467	\$1,257	\$1,467	\$1,257	\$1,437	\$1,227	\$1,467	\$1,257
Leather 3		\$1,527	\$1,317	\$1,527	\$1,317	\$1,497	\$1,287	\$1,527	\$1,317
Leather 4		\$1,587	\$1,377	\$1,587	\$1,377	\$1,557	\$1,347	\$1,587	\$1,377
Leather 5		\$1,647	\$1,437	\$1,647	\$1,437	\$1,617	\$1,407	\$1,647	\$1,437
Leather 6		\$1,707	\$1,497	\$1,707	\$1,497	\$1,677	\$1,467	\$1,707	\$1,497
Leather 8		\$2,172	\$1,962	\$2,172	\$1,962	\$2,142	\$1,932	\$2,172	\$1,962
Standard Seat Cushion		High Resiliency 40		High Resiliency 40		High Resiliency 40		High Resiliency 40	
Finish Options		Y	N	Y	N	Y	N	Y	N
Nail-head Trim	Small	45	45	45	45	45	45	45	45
	Medium	N/A	N/A	N/A	N/A	N/A	N/A	N/A	N/A

1300 Series Dining Chairs, Bar & Counter Stools

Stocked Finish Codes

Linen (-L) Mica (-M) Sheer Dove (-S) Tobacco (-T)

Name		Armless Counter Stool		Arm Chair		Arm Chair		Arm Chair	
		Arie		Conroy		Conroy		Conroy	
Fabric SKU Options		Finish Options	Stocked Finishes	Finish Options	Stocked Finishes	Finish Options	Stocked Finishes	Finish Options	Stocked Finishes
		1302-C7	1302-C7-L 1302-C7-M 1302-C7-S 1302-C7-T	1304-04	1304-04-L 1304-04-M 1304-04-S 1304-04-T	1304-A2	1304-A2-L 1304-A2-M 1304-A2-S 1304-A2-T	1304-A4	1304-A4-L 1304-A4-M 1304-A4-S 1304-A4-T
Overall Dimensions	Width	19.25		23.5		23.5		23.5	
	Depth	21		23.5		23.5		23.5	
	Height	36.5		36		36		36	
	Seat Height	23.5		20		20		20	
Seat Depth		16		18		18		18	
Inside Width		19.25		20		20		20	
Wrap, Carton Weight, Cubes		30, 30, 8.53		23, 22, 11.5		23, 22, 11.5		23, 22, 11.5	
		Finish Options	Stocked Finishes	Finish Options	Stocked Finishes	Finish Options	Stocked Finishes	Finish Options	Stocked Finishes
Grade D		\$987	\$897	\$987	\$897	\$1,017	\$927	\$1,047	\$987
Grade E		\$993	\$903	\$993	\$903	\$1,023	\$933	\$1,053	\$993
Grade F		\$999	\$909	\$999	\$909	\$1,029	\$939	\$1,059	\$999
Grade G		\$1,005	\$915	\$1,005	\$915	\$1,035	\$945	\$1,065	\$1,005
Grade H		\$1,011	\$921	\$1,011	\$921	\$1,041	\$951	\$1,071	\$1,011
Grade J		\$1,017	\$927	\$1,017	\$927	\$1,047	\$957	\$1,077	\$1,017
Grade K (COM)		\$1,023	\$933	\$1,023	\$933	\$1,053	\$963	\$1,083	\$1,023
Grade L		\$1,029	\$939	\$1,029	\$939	\$1,059	\$969	\$1,089	\$1,029
Grade M (COL)		\$1,035	\$945	\$1,035	\$945	\$1,065	\$975	\$1,095	\$1,035
Grade N		\$1,041	\$951	\$1,041	\$951	\$1,071	\$981	\$1,101	\$1,041
Grade O		\$1,047	\$957	\$1,047	\$957	\$1,077	\$987	\$1,107	\$1,047
Grade P		\$1,053	\$963	\$1,053	\$963	\$1,083	\$993	\$1,113	\$1,053
Grade Q		\$1,059	\$969	\$1,059	\$969	\$1,089	\$999	\$1,119	\$1,059
Grade R		\$1,065	\$975	\$1,065	\$975	\$1,095	\$1,005	\$1,125	\$1,065
Grade S		\$1,071	\$981	\$1,071	\$981	\$1,101	\$1,011	\$1,131	\$1,071
Grade T		\$1,077	\$987	\$1,077	\$987	\$1,107	\$1,017	\$1,137	\$1,077
Grade U		\$1,083	\$993	\$1,083	\$993	\$1,113	\$1,023	\$1,143	\$1,083
U+ Formula (See pg.12)		(# above U) x 6 + 1083	(# above U) x 6 + 993	(# above U) x 6 + 1083	(# above U) x 6 + 993	(# above U) x 6 + 1113	(# above U) x 6 + 1023	(# above U) x 6 + 1143	(# above U) x 6 + 1083
Riser		6		6		6		6	
COM (Yards)		2.00		1.75		1.75		1.75	
COL (sq. ft.)		34		34		34		34	
Leather SKU Pricing		Leather		Leather		Leather		Leather	
		Finish Options	Stocked Finishes	Finish Options	Stocked Finishes	Finish Options	Stocked Finishes	Finish Options	Stocked Finishes
		L-1302-C7	L-1302-C7-L L-1302-C7-M L-1302-C7-S L-1302-C7-T	L-1304-04	L-1304-04-L L-1304-04-M L-1304-04-S L-1304-04-T	L-1304-A2	L-1304-A2-L L-1304-A2-M L-1304-A2-S L-1304-A2-T	L-1304-A4	L-1304-A4-L L-1304-A4-M L-1304-A4-S L-1304-A4-T
Leather 1		\$1,407	\$1,197	\$1,407	\$1,197	\$1,437	\$1,227	\$1,467	\$1,257
Leather 2		\$1,467	\$1,257	\$1,467	\$1,257	\$1,497	\$1,287	\$1,527	\$1,317
Leather 3		\$1,527	\$1,317	\$1,527	\$1,317	\$1,557	\$1,347	\$1,587	\$1,377
Leather 4		\$1,587	\$1,377	\$1,587	\$1,377	\$1,617	\$1,407	\$1,647	\$1,437
Leather 5		\$1,647	\$1,437	\$1,647	\$1,437	\$1,677	\$1,467	\$1,707	\$1,497
Leather 6		\$1,707	\$1,497	\$1,707	\$1,497	\$1,737	\$1,527	\$1,767	\$1,557
Leather 8		\$2,172	\$1,962	\$2,172	\$1,962	\$2,202	\$1,992	\$2,232	\$2,022
Standard Seat Cushion		High Resiliency 40		High Resiliency 40		High Resiliency 40		High Resiliency 40	
Finish Options		Y	N	Y	N	Y	N	Y	N
Nail-head Trim	Small	45	45	45	45	45	45	45	45
	Medium	N/A	N/A	N/A	N/A	N/A	N/A	N/A	N/A

Stocked Finish Codes

Linen (-L) Mica (-M) Sheer Dove (-S) Tobacco (-T)

Name		Arm Chair Bennett		Arm Chair Bennett		Arm Chair Bennett		Arm Chair Addy	
		Finish Options	Stocked Finishes	Finish Options	Stocked Finishes	Finish Options	Stocked Finishes	Finish Options	Stocked Finishes
Fabric SKU Options		1305-04	1305-04-L 1305-04-M 1305-04-S 1305-04-T	1305-A2	1305-A2-L 1305-A2-M 1305-A2-S 1305-A2-T	1305-A4	1305-A4-L 1305-A4-M 1305-A4-S 1305-A4-T	1306-04	1306-04-L 1306-04-M 1306-04-S 1306-04-T
Overall Dimensions	Width	23.5		23.5		23.5		23.5	
	Depth	23.5		23.5		23.5		23.5	
	Height	36		36		36		36	
	Seat Height	20		20		20		20	
	Seat Depth	18		18		18		18	
	Inside Width	20		20		20		20	
Wrap, Carton Weight, Cubes		23, 22, 11.5		23, 22, 11.5		23, 22, 11.5		23, 22, 11.5	
		Finish Options	Stocked Finishes	Finish Options	Stocked Finishes	Finish Options	Stocked Finishes	Finish Options	Stocked Finishes
Grade D		\$987	\$897	\$1,017	\$927	\$1,047	\$987	\$987	\$897
Grade E		\$993	\$903	\$1,023	\$933	\$1,053	\$993	\$993	\$903
Grade F		\$999	\$909	\$1,029	\$939	\$1,059	\$999	\$999	\$909
Grade G		\$1,005	\$915	\$1,035	\$945	\$1,065	\$1,005	\$1,005	\$915
Grade H		\$1,011	\$921	\$1,041	\$951	\$1,071	\$1,011	\$1,011	\$921
Grade J		\$1,017	\$927	\$1,047	\$957	\$1,077	\$1,017	\$1,017	\$927
Grade K (COM)		\$1,023	\$933	\$1,053	\$963	\$1,083	\$1,023	\$1,023	\$933
Grade L		\$1,029	\$939	\$1,059	\$969	\$1,089	\$1,029	\$1,029	\$939
Grade M (COL)		\$1,035	\$945	\$1,065	\$975	\$1,095	\$1,035	\$1,035	\$945
Grade N		\$1,041	\$951	\$1,071	\$981	\$1,101	\$1,041	\$1,041	\$951
Grade O		\$1,047	\$957	\$1,077	\$987	\$1,107	\$1,047	\$1,047	\$957
Grade P		\$1,053	\$963	\$1,083	\$993	\$1,113	\$1,053	\$1,053	\$963
Grade Q		\$1,059	\$969	\$1,089	\$999	\$1,119	\$1,059	\$1,059	\$969
Grade R		\$1,065	\$975	\$1,095	\$1,005	\$1,125	\$1,065	\$1,065	\$975
Grade S		\$1,071	\$981	\$1,101	\$1,011	\$1,131	\$1,071	\$1,071	\$981
Grade T		\$1,077	\$987	\$1,107	\$1,017	\$1,137	\$1,077	\$1,077	\$987
Grade U		\$1,083	\$993	\$1,113	\$1,023	\$1,143	\$1,083	\$1,083	\$993
U+ Formula (See pg.12)		(# above U) x 6 + 1083	(# above U) x 6 + 993	(# above U) x 6 + 1113	(# above U) x 6 + 1023	(# above U) x 6 + 1143	(# above U) x 6 + 1083	(# above U) x 6 + 1083	(# above U) x 6 + 993
Riser		6		6		6		6	
COM (Yards)		2.25		2.25		2.25		1.75	
COL (sq. ft.)		34		34		34		34	
Leather SKU Pricing		Leather		Leather		Leather		Leather	
		Finish Options	Stocked Finishes	Finish Options	Stocked Finishes	Finish Options	Stocked Finishes	Finish Options	Stocked Finishes
		L-1305-04	L-1305-04-L L-1305-04-M L-1305-04-S L-1305-04-T	L-1305-A2	L-1305-A2-L L-1305-A2-M L-1305-A2-S L-1305-A2-T	L-1305-A4	L-1305-A4-L L-1305-A4-M L-1305-A4-S L-1305-A4-T	L-1306-04	L-1306-04-L L-1306-04-M L-1306-04-S L-1306-04-T
Leather 1		\$1,407	\$1,197	\$1,437	\$1,227	\$1,467	\$1,257	\$1,407	\$1,197
Leather 2		\$1,467	\$1,257	\$1,497	\$1,287	\$1,527	\$1,317	\$1,467	\$1,257
Leather 3		\$1,527	\$1,317	\$1,557	\$1,347	\$1,587	\$1,377	\$1,527	\$1,317
Leather 4		\$1,587	\$1,377	\$1,617	\$1,407	\$1,647	\$1,437	\$1,587	\$1,377
Leather 5		\$1,647	\$1,437	\$1,677	\$1,467	\$1,707	\$1,497	\$1,647	\$1,437
Leather 6		\$1,707	\$1,497	\$1,737	\$1,527	\$1,767	\$1,557	\$1,707	\$1,497
Leather 8		\$2,172	\$1,962	\$2,202	\$1,992	\$2,232	\$2,022	\$2,172	\$1,962
Standard Seat Cushion		High Resiliency 40		High Resiliency 40		High Resiliency 40		High Resiliency 40	
Finish Options		Y	N	Y	N	Y	N	Y	N
Nail-head Trim	Small	45	45	45	45	45	45	45	45
	Medium	N/A	N/A	N/A	N/A	N/A	N/A	N/A	N/A

1300 Series Dining Chairs, Bar & Counter Stools

Stocked Finish Codes

Linen (-L) Mica (-M) Sheer Dove (-S) Tobacco (-T)

Name		Arm Chair		Arm Chair	
		Addy		Addy	
Fabric SKU Options		Finish Options	Stocked Finishes	Finish Options	Stocked Finishes
				1306-A2	1306-A2-L 1306-A2-M 1306-A2-S 1306-A2-T
Overall Dimensions	Width	23.5		23.5	
	Depth	23.5		23.5	
	Height	36		36	
Seat Height		20		20	
Seat Depth		18		18	
Inside Width		20		20	
Wrap, Carton Weight, Cubes		23 , 22 , 11.5		23 , 22 , 11.5	
		Finish Options	Stocked Finishes	Finish Options	Stocked Finishes
Grade D		\$1,017	\$927	\$1,047	\$987
Grade E		\$1,023	\$933	\$1,053	\$993
Grade F		\$1,029	\$939	\$1,059	\$999
Grade G		\$1,035	\$945	\$1,065	\$1,005
Grade H		\$1,041	\$951	\$1,071	\$1,011
Grade J		\$1,047	\$957	\$1,077	\$1,017
Grade K (COM)		\$1,053	\$963	\$1,083	\$1,023
Grade L		\$1,059	\$969	\$1,089	\$1,029
Grade M (COL)		\$1,065	\$975	\$1,095	\$1,035
Grade N		\$1,071	\$981	\$1,101	\$1,041
Grade O		\$1,077	\$987	\$1,107	\$1,047
Grade P		\$1,083	\$993	\$1,113	\$1,053
Grade Q		\$1,089	\$999	\$1,119	\$1,059
Grade R		\$1,095	\$1,005	\$1,125	\$1,065
Grade S		\$1,101	\$1,011	\$1,131	\$1,071
Grade T		\$1,107	\$1,017	\$1,137	\$1,077
Grade U		\$1,113	\$1,023	\$1,143	\$1,083
U+ Formula (See pg.12)		(# above U) x 6 + 1113	(# above U) x 6 + 1023	(# above U) x 6 + 1143	(# above U) x 6 + 1083
Riser		6		6	
COM (Yards)		1.75		1.75	
COL (sq. ft.)		34		34	
Leather SKU Pricing		Leather		Leather	
		Finish Options	Stocked Finishes	Finish Options	Stocked Finishes
		L-1306-A2	L-1306-A2-L L-1306-A2-M L-1306-A2-S L-1306-A2-T	L-1306-A4	L-1306-A4-L L-1306-A4-M L-1306-A4-S L-1306-A4-T
Leather 1		\$1,437	\$1,227	\$1,467	\$1,257
Leather 2		\$1,497	\$1,287	\$1,527	\$1,317
Leather 3		\$1,557	\$1,347	\$1,587	\$1,377
Leather 4		\$1,617	\$1,407	\$1,647	\$1,437
Leather 5		\$1,677	\$1,467	\$1,707	\$1,497
Leather 6		\$1,737	\$1,527	\$1,767	\$1,557
Leather 8		\$2,202	\$1,992	\$2,232	\$2,022
Standard Seat Cushion		High Resiliency 40		High Resiliency 40	
Finish Options		Y	N	Y	N
Nail-head Trim	Small	45	45	45	45
	Medium	N/A	N/A	N/A	N/A

HAVENRESERVE



Haven Reserve is a configurable upholstery collection featuring ten stationary frames and twelve sectional components, benchmarked to your exact specifications by our skilled artisans in North Carolina. Each Haven Reserve piece is hand-crafted with premium construction elements and available in your choice of ten back pillow and seat cushion combinations, five arm silhouettes, four base options, and nailhead trim sizes, finishes and applications.

1300+ Fairfield Fabrics (plus COM)

5 arm options

10 pillow & cushion combinations

4 base options

22 frame options

step 1: select an arm option



1EXX-XX
English Arm, 6" wide



1PXX-XX
Welted Panel Arm, 9" wide



1SXX-XX
Welted Sock Arm, 9" wide



1TXX-XX
Welted Track Arm, 4" wide



1LXX-XX
Welted Slope Arm, 4" wide

step 2: select a back pillow welt option



Welted Box Border Back



Welted Knife Edge Back

step 2: select a back pillow/seat cushion configuration

Style	Back Pillow/Seat Cushion Combination
-01 - Lounge Chair -78 - Armless Lounge Chair -59 - Tilt Back Lounge Chair -32, F-32 - Swivel Glider -31, F-31 - Swivel Chair -27 - LAF Chaise -26 - RAF Chaise -20 - Ottoman*	<u>One over One Cushion</u> 1XB-XX Box Border 1XK-XX Knife Edge
-79 - Armless Loveseat -72 - LAF Loveseat -71 - RAF Loveseat -70 - Loveseat -20 - Ottoman*	<u>Two over One Cushion</u> 1XH-XX Box Border 1XN-XX Knife Edge <u>Two over Two Cushions</u> 1XB-XX Box Border 1XK-XX Knife Edge
-29 - Corner Chair -20 - Ottoman*	<u>Two over One Cushion</u> 1XB-XX Box Border 1XK-XX Knife Edge
-24 - Wedge -20 - Ottoman*	<u>Three over One Cushion</u> 1XB-XX Box Border 1XK-XX Knife Edge

Style	Back Pillow/Seat Cushion Combination
-50 - Sofa -51 - RAF Sofa -52 - LAF Sofa -60 - Sleeper -20 - Ottoman*	<u>Two over One Cushion</u> 1XD-XX Box Border 1XE-XX Knife Edge
-60 - Sleeper -52 - LAF Sofa -51 - RAF Sofa -50 - Sofa -20 - Ottoman*	<u>Two over Two Cushions</u> 1XR-XX Box Border 1XF-XX Knife Edge <u>Three over One Cushion</u> 1XH-XX Box Border 1XN-XX Knife Edge <u>Three over Three Cushions</u> 1XB-XX Box Border 1XK-XX Knife Edge
-54 - LAF Corner Sofa -53 - RAF Corner Sofa -20 - Ottoman*	<u>Three over Three Cushions</u> 1XB-XX Box Border 1XK-XX Knife Edge

*For the ease of ordering, -20 ottomans can be built with any back pillow/seat cushion configuration. Ottoman cushion construction is standard and will not change based on options selected above.

step 3: select a base option



1XXT-XX 
Tapered Square Leg, w2.5" h4"
Finish Options Available



1XXJ-XX 
Turned Jacobian Leg, w3.75" h4"
Finish Options Available



1XXS-XX
8" Skirt



1XXS-31
Swivel Chair
1XXS-32
Swivel Glider

Available with 8" skirt only.



1XXF-31 Swivel Chair,
Base to Floor
1XXF-32 Swivel Glider,
Base to Floor

Available with base to floor only.

Cushions: Haven Reserve offers the Classic Plush seat cushion as the standard with a fiber fill back pillow. Throw pillows are standard with 95/5 blendown fill.

Nailhead Trim Options: Optional nailhead trim is available around the base on all frame styles in small or medium size nails. Please refer to price list for complete information regarding nail placement per arm style.

Style Build Example

1

E

K

T

—

70

English
Arm

Knife Edge
Back

Tapered
Legs

Loveseat

How to Order:

1.
Select an
Arm Style

2.
Select a
Back Pillow/Seat
Cushion Config.



3.
Select a
Base Option

4.
Select a
Frame Style

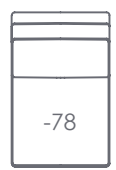
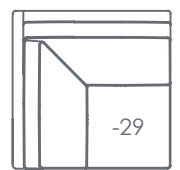

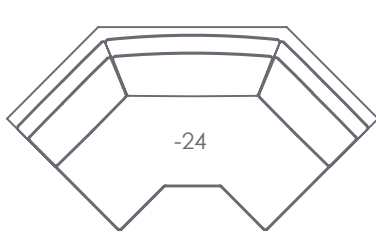
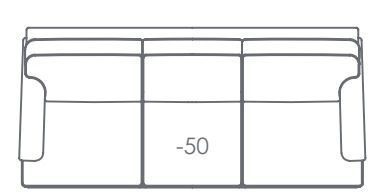
Frame	1XXX-01 Lounge Chair 1XXX-59 Tilt Back Lounge Chair 1XXS-31 Swivel Chair 1XXE-31 Base to Floor Swivel Chair 1XXS-32 Swivel Glider 1XXE-32 Base to Floor Swivel Glider	1XXX-78 Armless Lounge Chair	1XXX-29 Corner Chair	
<p>1XXS-31 Swivel Chair & 1XXS-32 Swivel Glider are only available with 8" Skirt.</p> <p>1XXE-31 Swivel Chair & 1-XXE-32 Swivel Glider are base to floor styles with no base options.</p>				
ARM STYLE	PILLOWS	N/A	N/A	Standard with (1) 20" throw pillow
	English Arm (E)	w33.5 d40 h38.5 in. ah26 sh19 sd21 iw21.5 in.	w25 d40 h38.5 in. sh19 sd21 in.	w40 d40 h38.5 in. sh19 sd21 iw21 in.
	Panel Arm (P)	w39.5 d40 h38.5 in. ah26 sh19 sd21 iw21.5 in.	w25 d40 h38.5 in. sh19 sd21 in.	w40 d40 h38.5 in. sh19 sd21 iw21 in.
	Sock Arm (S)	w39.5 d40 h38.5 in. ah26 sh19 sd21 iw21.5 in.	w25 d40 h38.5 in. sh19 sd21 in.	w40 d40 h38.5 in. sh19 sd21 iw21 in.
	Track Arm (T)	w31.5 d40 h38.5 in. ah26 sh19 sd21 iw22 in.	w25 d40 h38.5 in. sh19 sd21 in.	w40 d40 h38.5 in. sh19 sd21 iw21 in.
	Slope Arm (L)	w31.5 d40 h38.5 in. ah26 sh19 sd21 iw22 in.	w25 d40 h38.5 in. sh19 sd21 in.	w40 d40 h38.5 in. sh19 sd21 iw21 in.

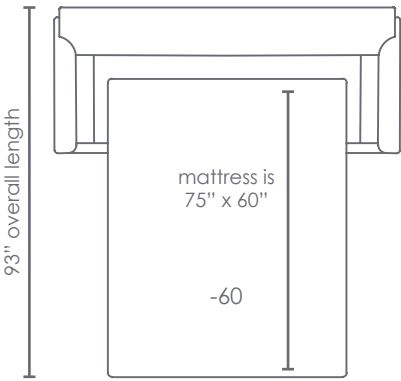
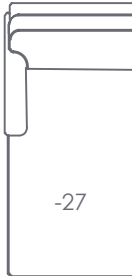
Frame	1XXX-20 Ottoman	1XXX-24 Wedge	1XXX-50 Sofa	
				
PILLOWS	N/A	Standard with (3) 20" throw pillows	Standard with (2) 20" throw pillows.	
ARM STYLE	English Arm (E)	w26 d21 h17 in.	w93.25 d51.25 h38.5 in. sh19 sd21 iw69.5 in.	w87 d40 h38.5 in. ah26 sh19 sd21 iw75 in.
	Panel Arm (P)	w26 d21 h17 in.	w93.25 d51.25 h38.5 in. sh19 sd21 iw69.5 in.	w93 d40 h38.5 in. ah26 sh19 sd21 iw75 in.
	Sock Arm (S)	w26 d21 h17 in.	w93.25 d51.25 h38.5 in. sh19 sd21 iw69.5 in.	w93 d40 h38.5 in. ah26 sh19 sd21 iw75 in.
	Track Arm (T)	w26 d21 h17 in.	w93.25 d51.25 h38.5 in. sh19 sd21 iw69.5 in.	w85 d40 h38.5 in. ah26 sh19 sd21 iw75 in.
	Slope Arm (L)	w26 d21 h17 in.	w93.25 d51.25 h38.5 in. sh19 sd21 iw69.5 in.	w85 d40 h38.5 in. ah26 sh19 sd21 iw75 in.

Frame	1XXX-60 Sleeper Sofa	1XXX-27 LAF Chaise	1XXX-26 RAF Chaise	
	 <p>93" overall length</p> <p>mattress is 75" x 60"</p> <p>-60</p>	 <p>-27</p>	 <p>-26</p>	
PILLOWS	Standard with (2) 20" throw pillows.	Standard with (1) 20" throw pillow	Standard with (1) 20" throw pillow	
ARM STYLE	English Arm (E)	w87 d40 h38.5 in. ah26 sh19 sd21 iw75 in. (closed)	w33.5 d69 h38.5 in. ah26 sh19 sd50 iw27.5 in.	w33.5 d69 h38.5 in. ah26 sh19 sd50 iw27.5 in.
	Panel Arm (P)	w93 d40 h38.5 in. ah26 sh19 sd21 iw75 in. (closed)	w36.5 d69 h38.5 in. ah26 sh19 sd50 iw27.5 in.	w36.5 d69 h38.5 in. ah26 sh19 sd50 iw27.5 in.
	Sock Arm (S)	w93 d40 h38.5 in. ah26 sh19 sd21 iw75 in. (closed)	w36.5 d69 h38.5 in. ah26 sh19 sd50 iw27.5 in.	w36.5 d69 h38.5 in. ah26 sh19 sd50 iw27.5 in.
	Track Arm (T)	w85 d40 h38.5 in. ah26 sh19 sd21 iw75 in. (closed)	w31.5 d69 h38.5 in. ah26 sh19 sd50 iw27.5 in.	w31.5 d69 h38.5 in. ah26 sh19 sd50 iw27.5 in.
	Slope Arm (L)	w85 d40 h38.5 in. ah26 sh19 sd21 iw75 in. (closed)	w31.5 d69 h38.5 in. ah26 sh19 sd50 iw27.5 in.	w31.5 d69 h38.5 in. ah26 sh19 sd50 iw27.5 in.

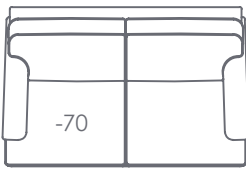
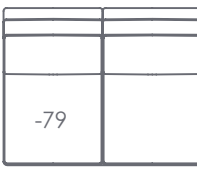
Frame	1XXX-70 Loveseat	1XXX-79 Armless Loveseat	
	 <p>-70</p>	 <p>-79</p>	
PILLOWS	Standard with (2) 20" throw pillows	N/A	
ARM STYLE	English Arm (E)	w62 d40 h38.5 in. ah26 sh19 sd21 iw50 in.	w50 d40 h38.5 in. sh19 sd21 in.
	Panel Arm (P)	w68 d40 h38.5 in. ah26 sh19 sd21 iw50 in.	w50 d40 h38.5 in. sh19 sd21 in.
	Sock Arm (S)	w68 d40 h38.5 in. ah26 sh19 sd21 iw50 in.	w50 d40 h38.5 in. sh19 sd21 in.
	Track Arm (T)	w60 d40 h38.5 in. ah26 sh19 sd21 iw50 in.	w50 d40 h38.5 in. sh19 sd21 in.
	Slope Arm (L)	w60 d40 h38.5 in. ah26 sh19 sd21 iw50 in.	w50 d40 h38.5 in. sh19 sd21 in.

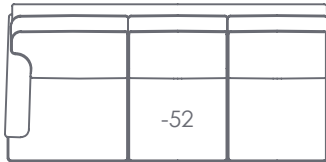
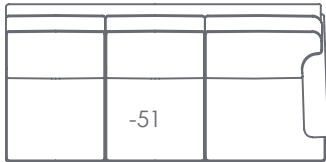
Frame	1XXX-52 LAF Sofa	1XXX-51 RAF Sofa	
			
PILLOWS	Standard with (1) 20" throw pillow	Standard with (1) 20" throw pillow	
ARM STYLE	English Arm (E)	w81 d40 h38.5 in. ah26 sh19 sd21 iw75 in.	w81 d40 h38.5 in. ah26 sh19 sd21 iw75 in.
	Panel Arm (P)	w84 d40 h38.5 in. ah26 sh19 sd21 iw75 in.	w84 d40 h38.5 in. ah26 sh19 sd21 iw75 in.
	Sock Arm (S)	w84 d40 h38.5 in. ah26 sh19 sd21 iw75 in.	w84 d40 h38.5 in. ah26 sh19 sd21 iw75 in.
	Track Arm (T)	w84 d40 h38.5 in. ah26 sh19 sd21 iw75 in.	w84 d40 h38.5 in. ah26 sh19 sd21 iw75 in.
	Slope Arm (L)	w84 d40 h38.5 in. ah26 sh19 sd21 iw75 in.	w84 d40 h38.5 in. ah26 sh19 sd21 iw75 in.

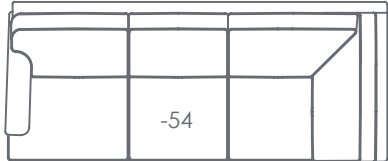
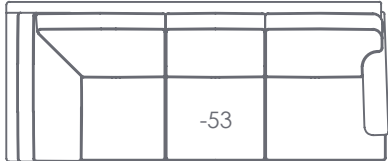
Frame	1XXX-54 LAF Corner Sofa	1XXX-53 RAF Corner Sofa	
			
PILLOWS	Standard with (3) 20" throw pillows	Standard with (3) 20" throw pillows	
ARM STYLE	English Arm (E)	w96 d40 h38.5 in. ah26 sh19 sd21 iw71 in.	w96 d40 h38.5 in. ah26 sh19 sd21 iw71 in.
	Panel Arm (P)	w99 d40 h38.5 in. ah26 sh19 sd21 iw71 in.	w99 d40 h38.5 in. ah26 sh19 sd21 iw71 in.
	Sock Arm (S)	w99 d40 h38.5 in. ah26 sh19 sd21 iw71 in.	w99 d40 h38.5 in. ah26 sh19 sd21 iw71 in.
	Track Arm (T)	w94 d40 h38.5 in. ah26 sh19 sd21 iw71 in.	w94 d40 h38.5 in. ah26 sh19 sd21 iw71 in.
	Slope Arm (L)	w94 d40 h38.5 in. ah26 sh19 sd21 iw71 in.	w94 d40 h38.5 in. ah26 sh19 sd21 iw71 in.

line drawings shown at 1/4 inch scale

HAVENRESERVE

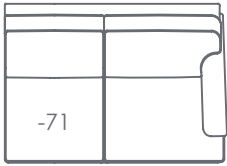
Frame		1XXX-72 LAF Loveseat	1XXX-71 RAF Loveseat
			
PILLOWS		Standard with (1) 20" throw pillow	Standard with (1) 20" throw pillow
ARM STYLE	English Arm (E)	w56 d40 h38.5 in. ah26 sh19 sd21 iw50 in.	w56 d40 h38.5 in. ah26 sh19 sd21 iw50 in.
	Panel Arm (P)	w59 d40 h38.5 in. ah26 sh19 sd21 iw50 in.	w59 d40 h38.5 in. ah26 sh19 sd21 iw50 in.
	Sock Arm (S)	w59 d40 h38.5 in. ah26 sh19 sd21 iw50 in.	w59 d40 h38.5 in. ah26 sh19 sd21 iw50 in.
	Track Arm (T)	w55 d40 h38.5 in. ah26 sh19 sd21 iw50 in.	w55 d40 h38.5 in. ah26 sh19 sd21 iw50 in.
	Slope Arm (L)	w55 d40 h38.5 in. ah26 sh19 sd21 iw50 in.	w55 d40 h38.5 in. ah26 sh19 sd21 iw50 in.

line drawings shown at 1/4 inch scale

Line drawings used are of the English Arm with box border back and 3 over 3 cushion configurations. Frame dimensions are the same for all seat and back pillow combinations.

Style Number		1(XXX)-01			1(XXX)-20		
Leather Number		L-1(XXX)-01			L-1(XXX)-20		
Name		Lounge Chair			Ottoman		
		ENGLISH ARM	PANEL ARM SOCK ARM	SLOPE ARM TRACK ARM	ENGLISH ARM	PANEL ARM SOCK ARM	SLOPE ARM TRACK ARM
Overall Dimensions	Width	33.5	39.5	31.5	26		
	Depth	40	40	40	21		
	Height	38.5			17		
	Arm Height	26			N/A		
	Seat Height	19			N/A		
	Seat Depth	21			N/A		
	Inside Width	21.5			N/A		
Standard Blendown Throw Pillow(s) <i>Fabric SKUs only</i>		N/A			N/A		
Wrap, Carton Weight, Cubes		76 , 87 , 34.38			19 , 28 , 10.77		
Grade D		\$2,691			\$1,041		
Grade E		\$2,724			\$1,050		
Grade F		\$2,757			\$1,059		
Grade G		\$2,790			\$1,068		
Grade H		\$2,823			\$1,077		
Grade J		\$2,856			\$1,086		
Grade K (COM)		\$2,889			\$1,095		
Grade L		\$2,922			\$1,104		
Grade M (COL)		\$2,955			\$1,113		
Grade N		\$2,988			\$1,122		
Grade O		\$3,021			\$1,131		
Grade P		\$3,054			\$1,140		
Grade Q		\$3,087			\$1,149		
Grade R		\$3,120			\$1,158		
Grade S		\$3,153			\$1,167		
Grade T		\$3,186			\$1,176		
Grade U		\$3,219			\$1,185		
U+ Formula (See pg.12)		(# above U) x 7 + 992			(# above U) x 7 + 992		
RISER		33			9		
COM (Yards)		10.25			2.50		
COL (sq. ft.)		135			45		
Leather 1		\$4,125			\$1,650		
Leather 2		\$4,335			\$1,725		
Leather 3		\$4,545			\$1,800		
Leather 4		\$4,755			\$1,875		
Leather 5		\$4,965			\$1,950		
Leather 6		\$5,175			\$2,025		
Leather 8		\$7,035			\$2,655		
Standard Seat Cushion		Classic Plush			High Resiliency 30		
Finish Options		Y			Y		
Nail-head Trim (Fabric)	Small	75	75	75	30		
	Medium	90	90	90	45		
Nail-head Trim (Leather)	Small	Std.	Std.	Std.	Std.		
	Medium	15	15	15	15		

*Nailhead Trim is not included on the base border of the Skirted Base option

Style Number		1(XXX)-24			1(XXX)-26		
Leather Number		L-1(XXX)-24			L-1(XXX)-26		
Name		Wedge			Right Arm Facing Chaise		
		ENGLISH ARM	PANEL ARM SOCK ARM	SLOPE ARM TRACK ARM	ENGLISH ARM	PANEL ARM SOCK ARM	SLOPE ARM TRACK ARM
Overall Dimensions	Width	93.25	93.25	93.25	33.5	36.5	31.5
	Depth	51.25	51.25	51.25	69	69	69
	Height	38.5			38.5		
Arm Height		N/A			26		
Seat Height		19			19		
Seat Depth		21			50		
Inside Width		69.5			27.5		
Standard Blendown Throw Pillow(s) <i>Fabric SKUs only</i>		(3)20 x 20			(1)20 x 20		
Wrap, Carton Weight, Cubes		145 , 193 , 129.08			109 , 143 , 59.39		
Grade D		\$4,785			\$3,219		
Grade E		\$4,845			\$3,258		
Grade F		\$4,905			\$3,297		
Grade G		\$4,965			\$3,336		
Grade H		\$5,025			\$3,375		
Grade J		\$5,085			\$3,414		
Grade K (COM)		\$5,145			\$3,453		
Grade L		\$5,205			\$3,492		
Grade M (COL)		\$5,265			\$3,531		
Grade N		\$5,325			\$3,570		
Grade O		\$5,385			\$3,609		
Grade P		\$5,445			\$3,648		
Grade Q		\$5,505			\$3,687		
Grade R		\$5,565			\$3,726		
Grade S		\$5,625			\$3,765		
Grade T		\$5,685			\$3,804		
Grade U		\$5,745			\$3,843		
U+ Formula (See pg.12)		(# above U) x 7 + 992			(# above U) x 7 + 992		
RISER		60			39		
COM (Yards)		18.75			12.50		
COL (sq. ft.)		265			169		
Leather 1		\$7,125			\$4,785		
Leather 2		\$7,530			\$5,040		
Leather 3		\$7,935			\$5,295		
Leather 4		\$8,340			\$5,550		
Leather 5		\$8,745			\$5,805		
Leather 6		\$9,150			\$6,060		
Leather 8		\$12,795			\$8,385		
Standard Seat Cushion		Classic Plush			Classic Plush		
Finish Options		Y			Y		
Nail-head Trim (Fabric)	Small	75	75	75	75	75	75
	Medium	90	90	90	90	90	90
Nail-head Trim (Leather)	Small	Std.	Std.	Std.	Std.	Std.	Std.
	Medium	15	15	15	15	15	15

*Nailhead Trim is not included on the base border of the Skirted Base option

Style Number		1(XXX)-27			1(XXX)-29		
Leather Number		L-1(XXX)-27			L-1(XXX)-29		
Name		Left Arm Facing Chaise			Corner Chair		
		ENGLISH ARM	PANEL ARM SOCK ARM	SLOPE ARM TRACK ARM	ENGLISH ARM	PANEL ARM SOCK ARM	SLOPE ARM TRACK ARM
Overall Dimensions	Width	33.5	36.5	31.5	40	40	40
	Depth	69	69	69	40	40	40
	Height	38.5			38.5		
Arm Height		26			N/A		
Seat Height		19			19		
Seat Depth		50			21		
Inside Width		27.5			21		
Standard Blendown Throw Pillow(s) <i>Fabric SKUs only</i>		(1)20 x 20			(1)20 x 20		
Wrap, Carton Weight, Cubes		109 , 144 , 59.39			78 , 95 , 36.49		
Grade D		\$3,219			\$2,691		
Grade E		\$3,258			\$2,724		
Grade F		\$3,297			\$2,757		
Grade G		\$3,336			\$2,790		
Grade H		\$3,375			\$2,823		
Grade J		\$3,414			\$2,856		
Grade K (COM)		\$3,453			\$2,889		
Grade L		\$3,492			\$2,922		
Grade M (COL)		\$3,531			\$2,955		
Grade N		\$3,570			\$2,988		
Grade O		\$3,609			\$3,021		
Grade P		\$3,648			\$3,054		
Grade Q		\$3,687			\$3,087		
Grade R		\$3,726			\$3,120		
Grade S		\$3,765			\$3,153		
Grade T		\$3,804			\$3,186		
Grade U		\$3,843			\$3,219		
U+ Formula (See pg.12)		(# above U) x 7 + 992			(# above U) x 7 + 992		
RISER		39			33		
COM (Yards)		12.50			11.50		
COL (sq. ft.)		169			158		
Leather 1		\$4,785			\$4,185		
Leather 2		\$5,040			\$4,425		
Leather 3		\$5,295			\$4,665		
Leather 4		\$5,550			\$4,905		
Leather 5		\$5,805			\$5,145		
Leather 6		\$6,060			\$5,385		
Leather 8		\$8,385			\$7,560		
Standard Seat Cushion		Classic Plush			Classic Plush		
Finish Options		Y			Y		
Nail-head Trim (Fabric)	Small	75	75	75	45	45	45
	Medium	90	90	90	60	60	60
Nail-head Trim (Leather)	Small	Std.	Std.	Std.	Std.	Std.	Std.
	Medium	15	15	15	15	15	15

*Nailhead Trim is not included on the base border of the Skirted Base option

Style Number		1(XXX)-31			1(XXX)-32		
Leather Number		L-1(XXX)-31			L-1(XXX)-32		
Name		Swivel Chair			Swivel Glider		
		ENGLISH ARM	PANEL ARM SOCK ARM	SLOPE ARM TRACK ARM	ENGLISH ARM	PANEL ARM SOCK ARM	SLOPE ARM TRACK ARM
Overall Dimensions	Width	33.5	39.5	31.5	33.5	39.5	31.5
	Depth	40	40	40	40	40	40
	Height	38.5			38.5		
Arm Height		26			26		
Seat Height		19			19		
Seat Depth		21			21		
Inside Width		21.5			21.5		
Standard Blendown Throw Pillow(s) <i>Fabric SKUs only</i>		N/A			N/A		
Wrap, Carton Weight, Cubes		82 , 82 , 29.85			86 , 86 , 29.85		
Grade D		\$2,772			\$2,937		
Grade E		\$2,805			\$2,970		
Grade F		\$2,838			\$3,003		
Grade G		\$2,871			\$3,036		
Grade H		\$2,904			\$3,069		
Grade J		\$2,937			\$3,102		
Grade K (COM)		\$2,970			\$3,135		
Grade L		\$3,003			\$3,168		
Grade M (COL)		\$3,036			\$3,201		
Grade N		\$3,069			\$3,234		
Grade O		\$3,102			\$3,267		
Grade P		\$3,135			\$3,300		
Grade Q		\$3,168			\$3,333		
Grade R		\$3,201			\$3,366		
Grade S		\$3,234			\$3,399		
Grade T		\$3,267			\$3,432		
Grade U		\$3,300			\$3,465		
U+ Formula (See pg.12)		(# above U) x 7 + 992			(# above U) x 7 + 992		
RISER		33			33		
COM (Yards)		11.75			11.50		
COL (sq. ft.)		135			135		
Leather 1		\$4,125			\$4,275		
Leather 2		\$4,335			\$4,485		
Leather 3		\$4,545			\$4,695		
Leather 4		\$4,755			\$4,905		
Leather 5		\$4,965			\$5,115		
Leather 6		\$5,175			\$5,325		
Leather 8		\$7,035			\$7,185		
Standard Seat Cushion		Classic Plush			Classic Plush		
Finish Options		N			N		
Nail-head Trim (Fabric)	Small	N/A	45	75	N/A	45	75
	Medium	N/A	N/A	N/A	N/A	N/A	N/A
Nail-head Trim (Leather)	Small	Std.	Std.	Std.	Std.	Std.	Std.
	Medium	15	15	15	15	15	15

*Nailhead Trim is not included on the base border of the Skirted Base option

Style Number		1(XXX)-50			1(XXX)-51		
Leather Number		L-1(XXX)-50			L-1(XXX)-51		
Name		Sofa			Right Arm Facing Sofa		
		ENGLISH ARM	PANEL ARM SOCK ARM	SLOPE ARM TRACK ARM	ENGLISH ARM	PANEL ARM SOCK ARM	SLOPE ARM TRACK ARM
Overall Dimensions	Width	87	93	85	81	84	80
	Depth	40	40	40	40	40	40
	Height	38.5			38.5		
Arm Height		26			26		
Seat Height		19			19		
Seat Depth		21			21		
Inside Width		75			75		
Standard Blendown Throw Pillow(s) <i>Fabric SKUs only</i>		(2)20 x 20			(1)20 x 20		
Wrap, Carton Weight, Cubes		165 , 196 , 79.34			160 , 198 , 79.34		
Grade D		\$4,620			\$4,158		
Grade E		\$4,668			\$4,206		
Grade F		\$4,716			\$4,254		
Grade G		\$4,764			\$4,302		
Grade H		\$4,812			\$4,350		
Grade J		\$4,860			\$4,398		
Grade K (COM)		\$4,908			\$4,446		
Grade L		\$4,956			\$4,494		
Grade M (COL)		\$5,004			\$4,542		
Grade N		\$5,052			\$4,590		
Grade O		\$5,100			\$4,638		
Grade P		\$5,148			\$4,686		
Grade Q		\$5,196			\$4,734		
Grade R		\$5,244			\$4,782		
Grade S		\$5,292			\$4,830		
Grade T		\$5,340			\$4,878		
Grade U		\$5,388			\$4,926		
U+ Formula (See pg.12)		(# above U) x 7 + 992			(# above U) x 7 + 992		
RISER		48			48		
COM (Yards)		18.25			16.00		
COL (sq. ft.)		276			254		
Leather 1		\$7,425			\$6,750		
Leather 2		\$7,845			\$7,140		
Leather 3		\$8,265			\$7,530		
Leather 4		\$8,685			\$7,920		
Leather 5		\$9,105			\$8,310		
Leather 6		\$9,525			\$8,700		
Leather 8		\$13,320			\$12,195		
Standard Seat Cushion		Classic Plush			Classic Plush		
Finish Options		Y			Y		
Nail-head Trim (Fabric)	Small	120	120	120	90	90	90
	Medium	135	135	135	105	105	105
Nail-head Trim (Leather)	Small	Std.	Std.	Std.	Std.	Std.	Std.
	Medium	15	15	15	15	15	15

*Nailhead Trim is not included on the base border of the Skirted Base option

Style Number		1(XXX)-52			1(XXX)-53		
Leather Number		L-1(XXX)-52			L-1(XXX)-53		
Name		Left Arm Facing Sofa			Right Arm Facing Corner Sofa		
		ENGLISH ARM	PANEL ARM SOCK ARM	SLOPE ARM TRACK ARM	ENGLISH ARM	PANEL ARM SOCK ARM	SLOPE ARM TRACK ARM
Overall Dimensions	Width	81	84	80	96	99	94
	Depth	40	40	40	40	40	40
	Height	38.5			38.5		
Arm Height		26			26		
Seat Height		19			19		
Seat Depth		21			21		
Inside Width		75			71		
Standard Blendown Throw Pillow(s) <i>Fabric SKUs only</i>		(1)20 x 20			(3)20 x 20		
Wrap, Carton Weight, Cubes		160 , 198 , 79.34			185 , 209 , 92.4		
Grade D		\$4,158			\$4,950		
Grade E		\$4,206			\$5,010		
Grade F		\$4,254			\$5,070		
Grade G		\$4,302			\$5,130		
Grade H		\$4,350			\$5,190		
Grade J		\$4,398			\$5,250		
Grade K (COM)		\$4,446			\$5,310		
Grade L		\$4,494			\$5,370		
Grade M (COL)		\$4,542			\$5,430		
Grade N		\$4,590			\$5,490		
Grade O		\$4,638			\$5,550		
Grade P		\$4,686			\$5,610		
Grade Q		\$4,734			\$5,670		
Grade R		\$4,782			\$5,730		
Grade S		\$4,830			\$5,790		
Grade T		\$4,878			\$5,850		
Grade U		\$4,926			\$5,910		
U+ Formula (See pg.12)		(# above U) x 7 + 992			(# above U) x 7 + 992		
RISER		48			60		
COM (Yards)		16.00			20.75		
COL (sq. ft.)		254			310		
Leather 1		\$6,750			\$7,875		
Leather 2		\$7,140			\$8,340		
Leather 3		\$7,530			\$8,805		
Leather 4		\$7,920			\$9,270		
Leather 5		\$8,310			\$9,735		
Leather 6		\$8,700			\$10,200		
Leather 8		\$12,195			\$14,460		
Standard Seat Cushion		Classic Plush			Classic Plush		
Finish Options		Y			Y		
Nail-head Trim (Fabric)	Small	90	90	90	105	105	105
	Medium	105	105	105	120	120	120
Nail-head Trim (Leather)	Small	Std.	Std.	Std.	Std.	Std.	Std.
	Medium	15	15	15	15	15	15

*Nailhead Trim is not included on the base border of the Skirted Base option

Style Number		1(XXX)-54			1(XXX)-59		
Leather Number		L-1(XXX)-54			L-1(XXX)-59		
Name		Left Arm Facing Corner Sofa			Tilt Back Chair		
		ENGLISH ARM	PANEL ARM SOCK ARM	SLOPE ARM TRACK ARM	ENGLISH ARM	PANEL ARM SOCK ARM	SLOPE ARM TRACK ARM
Overall Dimensions	Width	96	99	94	33.5	39.5	31.5
	Depth	40	40	40	40	40	40
	Height	38.5			38.5		
Arm Height		26			26		
Seat Height		19			19		
Seat Depth		21			21		
Inside Width		71			21.5		
Standard Blendown Throw Pillow(s) <i>Fabric SKUs only</i>		(3)20 x 20			N/A		
Wrap, Carton Weight, Cubes		185 , 209 , 85.55			81 , 95 , 29.85		
Grade D		\$4,950			\$3,219		
Grade E		\$5,010			\$3,249		
Grade F		\$5,070			\$3,279		
Grade G		\$5,130			\$3,309		
Grade H		\$5,190			\$3,339		
Grade J		\$5,250			\$3,369		
Grade K (COM)		\$5,310			\$3,399		
Grade L		\$5,370			\$3,429		
Grade M (COL)		\$5,430			\$3,459		
Grade N		\$5,490			\$3,489		
Grade O		\$5,550			\$3,519		
Grade P		\$5,610			\$3,549		
Grade Q		\$5,670			\$3,579		
Grade R		\$5,730			\$3,609		
Grade S		\$5,790			\$3,639		
Grade T		\$5,850			\$3,669		
Grade U		\$5,910			\$3,699		
U+ Formula (See pg.12)		(# above U) x 7 + 992			(# above U) x 7 + 992		
RISER		60			30		
COM (Yards)		20.75			9.75		
COL (sq. ft.)		310			147		
Leather 1		\$7,875			\$4,725		
Leather 2		\$8,340			\$4,950		
Leather 3		\$8,805			\$5,175		
Leather 4		\$9,270			\$5,400		
Leather 5		\$9,735			\$5,625		
Leather 6		\$10,200			\$5,850		
Leather 8		\$14,460			\$7,875		
Standard Seat Cushion		Classic Plush			Classic Plush		
Finish Options		Y			Y		
Nail-head Trim (Fabric)	Small	105	105	105	75	75	75
	Medium	120	120	120	90	90	90
Nail-head Trim (Leather)	Small	Std.	Std.	Std.	Std.	Std.	Std.
	Medium	15	15	15	15	15	15

*Nailhead Trim is not included on the base border of the Skirted Base option

Style Number		1(XXX)-60			1(XXX)-70		
Leather Number		L-1(XXX)-60			L-1(XXX)-70		
Name		Queen Sleeper			Loveseat		
		ENGLISH ARM	PANEL ARM SOCK ARM	SLOPE ARM TRACK ARM	ENGLISH ARM	PANEL ARM SOCK ARM	SLOPE ARM TRACK ARM
Overall Dimensions	Width	87	93	85	62	68	60
	Depth	40	40	40	40	40	40
	Height	41.5			38.5		
Arm Height		26			26		
Seat Height		22			19		
Seat Depth		21			21		
Inside Width		75			50		
Standard Blendown Throw Pillow(s) <i>Fabric SKUs only</i>		(2)20 x 20			(2)20 x 20		
Wrap, Carton Weight, Cubes		250 , 274 , 79.34			135 , 167 , 61.76		
Grade D		\$5,364			\$3,714		
Grade E		\$5,421			\$3,762		
Grade F		\$5,478			\$3,810		
Grade G		\$5,535			\$3,858		
Grade H		\$5,592			\$3,906		
Grade J		\$5,649			\$3,954		
Grade K (COM)		\$5,706			\$4,002		
Grade L		\$5,763			\$4,050		
Grade M (COL)		\$5,820			\$4,098		
Grade N		\$5,877			\$4,146		
Grade O		\$5,934			\$4,194		
Grade P		\$5,991			\$4,242		
Grade Q		\$6,048			\$4,290		
Grade R		\$6,105			\$4,338		
Grade S		\$6,162			\$4,386		
Grade T		\$6,219			\$4,434		
Grade U		\$6,276			\$4,482		
U+ Formula (See pg.12)		(# above U) x 7 + 992			(# above U) x 7 + 992		
RISER		57			48		
COM (Yards)		19.75			15.50		
COL (sq. ft.)		299			209		
Leather 1		\$8,250			\$5,775		
Leather 2		\$8,685			\$6,090		
Leather 3		\$9,120			\$6,405		
Leather 4		\$9,555			\$6,720		
Leather 5		\$9,990			\$7,035		
Leather 6		\$10,425			\$7,350		
Leather 8		\$14,370			\$10,230		
Standard Seat Cushion		Classic Plush			Classic Plush		
Finish Options		Y			Y		
Nail-head Trim (Fabric)	Small	120	120	120	105	105	105
	Medium	135	135	135	120	120	120
Nail-head Trim (Leather)	Small	Std.	Std.	Std.	Std.	Std.	Std.
	Medium	15	15	15	15	15	15

*Nailhead Trim is not included on the base border of the Skirted Base option

Style Number		1(XXX)-71			1(XXX)-72		
Leather Number		L-1(XXX)-71			L-1(XXX)-72		
Name		Right Arm Facing Loveseat			Left Arm Facing Loveseat		
		ENGLISH ARM	PANEL ARM SOCK ARM	SLOPE ARM TRACK ARM	ENGLISH ARM	PANEL ARM SOCK ARM	SLOPE ARM TRACK ARM
Overall Dimensions	Width	56	59	55	56	59	55
	Depth	40	40	40	40	40	40
	Height	38.5			38.5		
Arm Height		26			26		
Seat Height		19			19		
Seat Depth		21			21		
Inside Width		50			50		
Standard Blendown Throw Pillow(s) <i>Fabric SKUs only</i>		(1)20 x 20			(1)20 x 20		
Wrap, Carton Weight, Cubes		130 , 162 , 61.76			130 , 162 , 61.76		
Grade D		\$3,384			\$3,384		
Grade E		\$3,423			\$3,423		
Grade F		\$3,462			\$3,462		
Grade G		\$3,501			\$3,501		
Grade H		\$3,540			\$3,540		
Grade J		\$3,579			\$3,579		
Grade K (COM)		\$3,618			\$3,618		
Grade L		\$3,657			\$3,657		
Grade M (COL)		\$3,696			\$3,696		
Grade N		\$3,735			\$3,735		
Grade O		\$3,774			\$3,774		
Grade P		\$3,813			\$3,813		
Grade Q		\$3,852			\$3,852		
Grade R		\$3,891			\$3,891		
Grade S		\$3,930			\$3,930		
Grade T		\$3,969			\$3,969		
Grade U		\$4,008			\$4,008		
U+ Formula (See pg.12)		(# above U) x 7 + 992			(# above U) x 7 + 992		
RISER		39			39		
COM (Yards)		12.75			12.75		
COL (sq. ft.)		192			192		
Leather 1		\$5,385			\$5,385		
Leather 2		\$5,685			\$5,685		
Leather 3		\$5,985			\$5,985		
Leather 4		\$6,285			\$6,285		
Leather 5		\$6,585			\$6,585		
Leather 6		\$6,885			\$6,885		
Leather 8		\$9,525			\$9,525		
Standard Seat Cushion		Classic Plush			Classic Plush		
Finish Options		Y			Y		
Nail-head Trim (Fabric)	Small	105	105	105	105	105	105
	Medium	120	120	120	120	120	120
Nail-head Trim (Leather)	Small	Std.	Std.	Std.	Std.	Std.	Std.
	Medium	15	15	15	15	15	15

*Nailhead Trim is not included on the base border of the Skirted Base option

Style Number		1(XXX)-78			1(XXX)-79		
Leather Number		L-1(XXX)-78			L-1(XXX)-79		
Name		Armless Chair			Armless Loveseat		
		ENGLISH ARM	PANEL ARM SOCK ARM	SLOPE ARM TRACK ARM	ENGLISH ARM	PANEL ARM SOCK ARM	SLOPE ARM TRACK ARM
Overall Dimensions	Width	25			50		
	Depth	40			40		
	Height	38.5			38.5		
	Arm Height	N/A			N/A		
	Seat Height	19			19		
	Seat Depth	21			21		
	Inside Width	N/A			N/A		
Standard Blendown Throw Pillow(s) <i>Fabric SKUs only</i>		N/A			N/A		
Wrap, Carton Weight, Cubes		63 , 82 , 31.99			125 , 152 , 50.95		
Grade D		\$2,031			\$2,937		
Grade E		\$2,049			\$2,967		
Grade F		\$2,067			\$2,997		
Grade G		\$2,085			\$3,027		
Grade H		\$2,103			\$3,057		
Grade J		\$2,121			\$3,087		
Grade K (COM)		\$2,139			\$3,117		
Grade L		\$2,157			\$3,147		
Grade M (COL)		\$2,175			\$3,177		
Grade N		\$2,193			\$3,207		
Grade O		\$2,211			\$3,237		
Grade P		\$2,229			\$3,267		
Grade Q		\$2,247			\$3,297		
Grade R		\$2,265			\$3,327		
Grade S		\$2,283			\$3,357		
Grade T		\$2,301			\$3,387		
Grade U		\$2,319			\$3,417		
U+ Formula (See pg.12)		(# above U) x 7 + 992			(# above U) x 7 + 992		
RISER		18			30		
COM (Yards)		6.00			9.75		
COL (sq. ft.)		102			169		
Leather 1		\$3,150			\$4,725		
Leather 2		\$3,315			\$4,980		
Leather 3		\$3,480			\$5,235		
Leather 4		\$3,645			\$5,490		
Leather 5		\$3,810			\$5,745		
Leather 6		\$3,975			\$6,000		
Leather 8		\$5,385			\$8,325		
Standard Seat Cushion		Classic Plush			Classic Plush		
Finish Options		Y			Y		
Nail-head Trim (Fabric)	Small	45	45	45	60	60	60
	Medium	60	60	60	75	75	75
Nail-head Trim (Leather)	Small	Std.	Std.	Std.	Std.	Std.	Std.
	Medium	15	15	15	15	15	15

*Nailhead Trim is not included on the base border of the Skirted Base option

URBANLIVING

Offering comprehensive choices and personalized seating designs that reflect your unique style. Urban Living styles are standard with Blendown throw pillows, back pillows and seat cushions. Nailhead trim is available as an optional upgrade. Throw pillows are not standard with vinyl application.

1300+ Fairfield Fabrics (plus COM)

2 seat options

4 arm options





2 back options

5 base options

48 frame options

step 1: select a seat option (S) = Standard Cushion or (B) = Bench Seat, available on sofas only | Then select additional frame options

step 2: select an arm option

<p>Border Track Arm XBXX-XX</p>  <p>8" wide</p> <p>Optional nailhead trim is available.</p> <ul style="list-style-type: none"> • Small size nailhead trim is available in the place of welt. Trim is placed as a double border on front rail, arm panel, top of arm and top of back rail. • Medium nailhead trim is available on the welt of borders. Spaced 1" apart from the front rail, arm panel, top of arm and top of back rail. 	<p>Chamfered Arm XHXX-XX</p>  <p>top 3.5" bottom 8"</p> <p>Optional nailhead trim is available.</p> <ul style="list-style-type: none"> • Small size nailhead trim is available at the base. Placement is on the front rail, side rails and back rail. • Medium nailhead trim is available and spaced 1" apart and placed on the base of the front rail, side rails and back rail.
<p>Clipped Arm XCXX-XX</p>  <p>top 4" bottom 8"</p> <p>Optional nailhead trim is available.</p> <ul style="list-style-type: none"> • Small size nailhead trim is available. Placement is head to head on the base of the front rail, side rails and back rail. • Medium nailhead trim is available and spaced 1" apart and placed on the base of the front rail, side rails and back rail. 	<p>Small Track Arm XSXX-XX</p>  <p>2.75" wide</p> <p>Optional nailhead trim is available.</p> <ul style="list-style-type: none"> • Small size nailhead trim is available on the inside arm over welt (rectangular shape), on the outside arm over welt (rectangular shape) and on the outside back over welt (rectangular shape). • Medium nailhead trim is not available

step 3: select a back option Standard with English Seam



XXBX-XX
Border Back



XXMX-XX
20" Multi-Pillow Back

step 4: select a base option



XXXA-XX
Acrylic Leg
w4 d 4h 3.5 in.



XXXM-XX
Metal Leg
nickel finish | w4 d4 h3.5 in.



XXXM-XX
Metal Leg
bronze finish | w4 d4 h3.5 in.



XXXP-XX
Plinth Base
brown finish | w5 d5 h1 in.



XXXW-XX
Wood Leg
w5 d5 h3.5 in.



Style Build Example:

S C M W - 50
Standard Cushion Clipped Arm Multi-Pillow Back Wood Leg Sofa

step 5: select your individual styles

Border Track Arm (B) & Chamfered Arm (H)

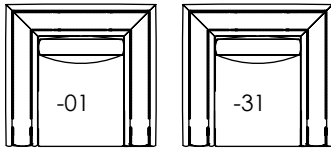

XXXX-01 Lounge Chair
w38 d38.5 h32.5 in.
ah26 sh19.5 sd21.5 iw22 in.

XXXX-31 Swivel Chair
w38 d38.5 h32.5 in.
ah26 sh19.5 sd21.5 iw22 in.
Available with Plinth Base Only

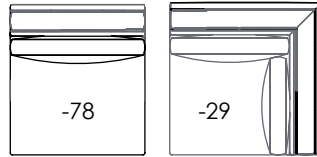

XXXX-78 Armless Chair
w34 d38.5 h32.5 in.
ah26 sh19.5 sd21.5 iw34 in.

XXXX-29 Corner Chair
w38.5 d38.5 h32.5 in.
ah26 sh19.5 sd21.5 iw21.5 in.

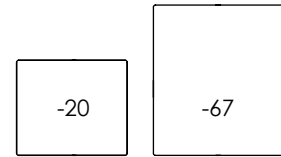

XXXX-20 Ottoman
w28 d24 h16.5 in.

XXXX-67 Bumper Ottoman
w34 d38.5 h19.5 in.

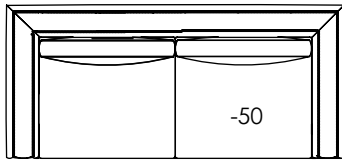

XXXX-50 Sofa
w85 d38.5 h32.5 in.
ah26 sh19.5 sd21.5 iw68 in.
Standard with (2) 18" throw pillows

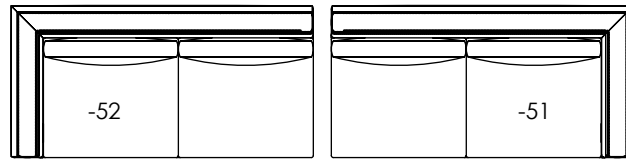

XXXX-52 LAF Sofa | XXXX-51 RAF Sofa
w76 d38.5 h32.5 in.
ah26 sh19.5 sd21.5 iw68 in.
Standard with (1) 18" throw pillow

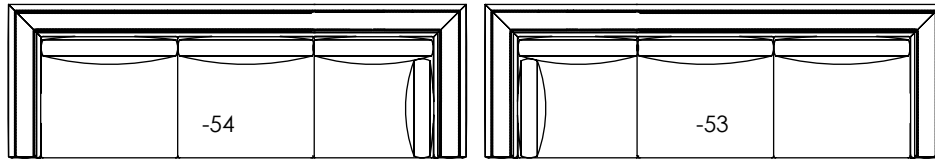

XXXX-54 LAF Corner Sofa | XXXX-53 RAF Corner Sofa
w115 d38.5 h32.5 in.
ah26 sh19.5 sd21.5 iw89.5 in.
Standard with (2) 18" throw pillows

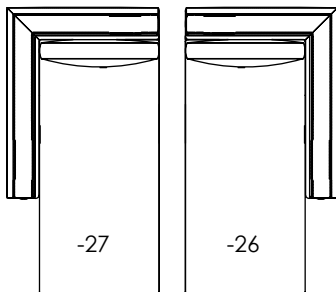

XXXX-27 LAF Chaise | XXXX-26 RAF Chaise
w38.5 d72 h32.5 in.
ah26 sh19.5 sd53 iw30 in.
Standard with (1) 18" throw pillow

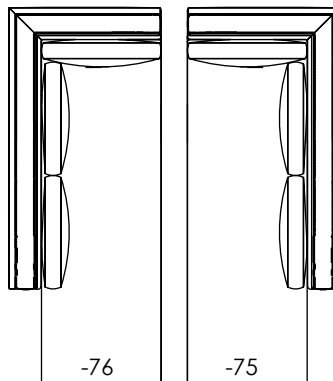

XXXX-75 RAF Cuddle Chaise
w38.5 d95.5 h32.5 in.
ah26 sh19.5 sd78 iw21.5 in.

XXXX-76 LAF Cuddle Chaise
w38.5 d95.5 h32.5 in.
ah26 sh19.5 sd78 iw21.5 in.
Standard with (1) 18" throw pillow

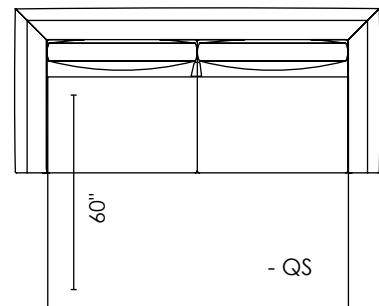

XXXX-QS Queen Sleeper Sofa
w94.75 d39.75 h32 in.
ah25.5 sh17.5 sd23 iw79 in.
Standard with (2) 18" Blendown
throw pillows

The Urban Living Queen Sleeper
is available with each arm style, with
a bench seat, border back pillow and
with the Plinth leg option only

line drawings shown at 1/4 inch scale

Clipped Arm (C)

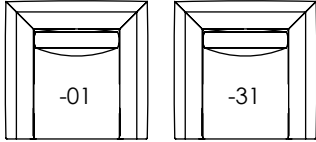

XXXX-01 Lounge Chair
w36 d37.5 h32.5 in.
ah26 sh19.5 sd21.5 iw22 in.

XXXX-31 Swivel Chair
w36 d37.5 h32.5 in.
ah26 sh19.5 sd21.5 iw22 in.
Available with Plinth Base Only

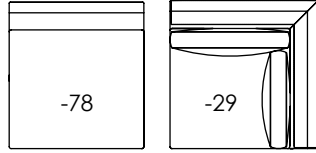

XXXX-78 Armless Chair
w34 d37.5 h32.5 in.
ah26 sh19.5 sd21.5 iw34 in.

XXXX-29 Corner Chair
w34 d37.5 h32.5 in.
ah26 sh19.5 sd21.5 iw21.5 in.

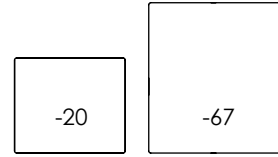

XXXX-20 Ottoman
w28 d24 h16 in.

XXXX-67 Bumper Ottoman
w34 d37.5 h19.5 in.

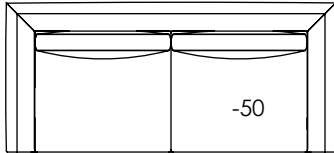

XXXX-50 Sofa
w83 d37.5 h32.5 in.
ah26 sh19.5 sd21.5 iw68 in.
Standard with (2) 18" throw pillows

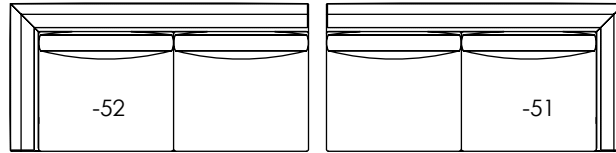

XXXX-52 LAF Sofa | XXXX-51 RAF Sofa
w75 d37.5 h32.5 in.
ah26 sh19.5 sd21.5 iw68 in.
Standard with (1) 18" throw pillow

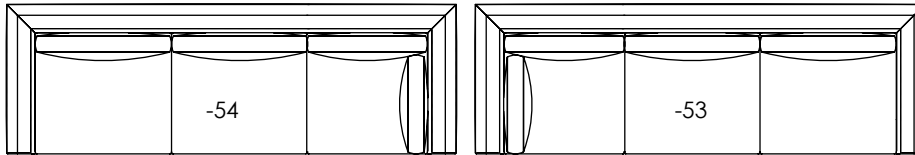

XXXX-54 LAF Corner Sofa | XXXX-53 RAF Corner Sofa
w113 d37.5 h32.5 in.
ah26 sh19.5 sd21.5 iw89.5 in.
Standard with (2) 18" throw pillows

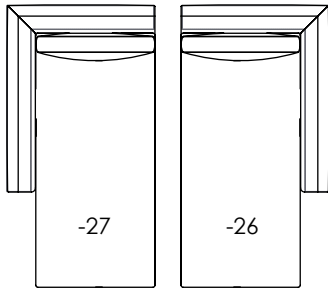

XXXX-27 LAF Chaise | XXXX-26 RAF Chaise
w37.5 d71 h32.5 in.
ah26 sh19.5 sd53 iw30 in.
Standard with (1) 18" throw pillow

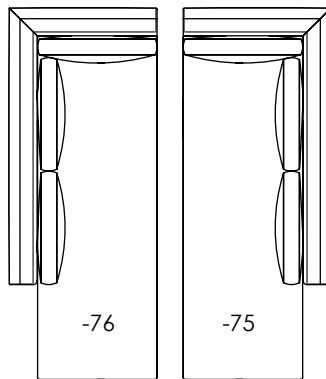

XXXX-76 LAF Cuddle Chaise
w37.5 d94.5 h32.5 in.
ah26 sh19.5 sd78 iw21.5 in.

XXXX-75 RAF Cuddle Chaise
w37.5 d94.5 h32.5 in.
ah26 sh19.5 sd78 iw21.5 in.
Standard with (1) 18" throw pillow

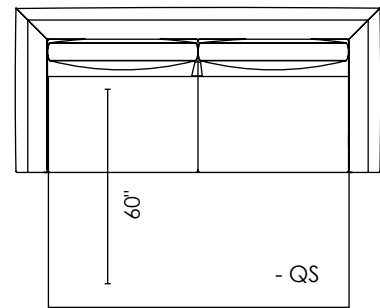

XXXX-QS Queen Sleeper Sofa
w92.75 d38 h32 in.
ah25.5 sh17.5 sd23 iw79 in.
Standard with (2) 18" Blendown
throw pillows

The Urban Living Queen Sleeper
is available with each arm style, with
a bench seat, border back pillow and
with the Plinth leg option only

line drawings shown at 1/4 inch scale

Small Track Arm (S)

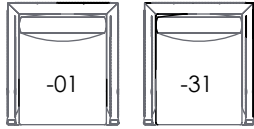

XXXX-01 Lounge Chair
w28 d33 h32.5 in.
ah26 sh19.5 sd21.5 iw22 in.

XXXX-31 Swivel Chair
w28 d32.5 h32.5 in.
ah26 sh19.5 sd21.5 iw22 in.
Available with Plinth Base Only

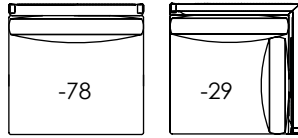

XXXX-78 Armless Chair
w34 d33 h32.5 in.
ah26 sh19.5 sd21.5 iw34 in.

XXXX-29 Corner Chair
w33 d33 h32.5 in.
ah26 sh19.5 sd21.5 iw21.5 in.

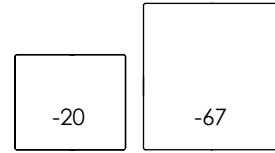

XXXX-20 Ottoman
w28 d24 h16 in.

XXXX-67 Bumper Ottoman
w34 d33 h19.5 in.

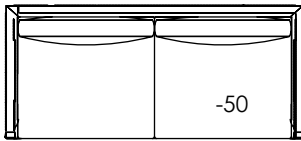

XXXX-50 Sofa
w75 d33 h32.5 in.
ah26 sh19.5 sd21.5 iw68 in.
Standard with (2) 18" throw pillows

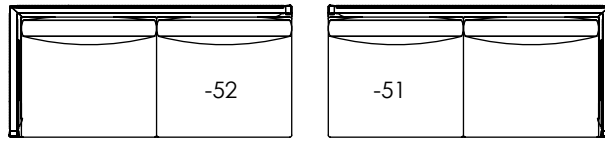

XXXX-52 LAF Sofa | XXXX-51 RAF Sofa
w71 d33 h32.5 in.
ah26 sh19.5 sd21.5 iw68 in.
Standard with (1) 18" throw pillow

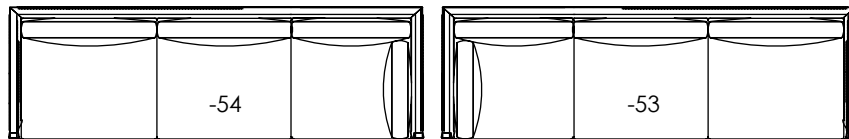

XXXX-54 LAF Corner Sofa | XXXX-53 RAF Corner Sofa
w104 d33 h32.5 in.
ah26 sh19.5 sd21.5 iw89.5 in.
Standard with (2) 18" throw pillows

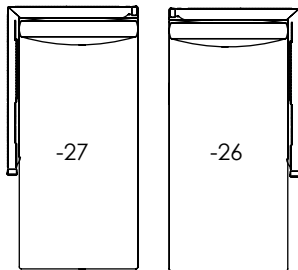

XXXX-27 LAF Chaise
w33 d67 h32.5 in.
ah26 sh19.5 sd53 iw30 in.

XXXX-26 RAF Chaise
w33 d67 h32.5 in.
ah26 sh19.5 sd53 iw30 in.
Standard with (1) 18" throw pillow

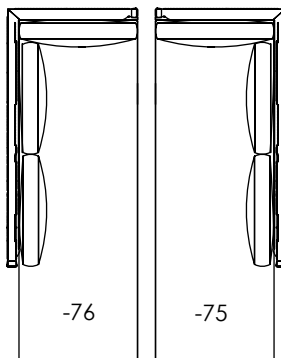

XXXX-76 LAF Cuddle Chaise
w33 d90 h32.5 in.
ah26 sh19.5 sd78 iw21.5 in.

XXXX-75 RAF Cuddle Chaise
w33 d90 h32.5 in.
ah26 sh19.5 sd78 iw21.5 in.
Standard with (1) 18" throw pillow

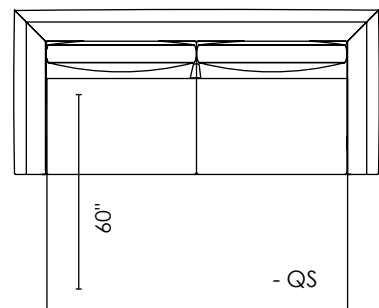

XXXX-QS Queen Sleeper Sofa
w84 d36.5 h32 in.
ah25.5 sh17.5 sd23 iw79 in.
Standard with (2) 18" Blendown
throw pillows

The Urban Living Queen Sleeper
is available with each arm style, with
a bench seat, border back pillow and
with the Plinth leg option only

line drawings shown at 1/4 inch scale

Style Number		(XXXX)-01			(XXXX)-20		
		Lounge Chair			Ottoman		
		BORDER TRACK ARM CHAMFERED ARM	SMALL TRACK ARM	CLIPPED ARM	BORDER TRACK ARM CHAMFERED ARM	SMALL TRACK ARM	CLIPPED ARM
Overall Dimensions	Width	38	28	36	28	28	28
	Depth	38.5	33	37.5	24	24	24
	Height	32.5			16.5		
Arm Height		26			N/A		
Seat Height		19.5			16.5		
Seat Depth		21.5			24		
Inside Width		22			28		
Standard Blendown Throw Pillow(s)		N/A			N/A		
Wrap , Carton Weight, Cubes		80 , 90 , 27.51			33 , 42 , 10.77		
Grade D		\$2,640			\$1,239		
Grade E		\$2,661			\$1,248		
Grade F		\$2,682			\$1,257		
Grade G		\$2,703			\$1,266		
Grade H		\$2,724			\$1,275		
Grade J		\$2,745			\$1,284		
Grade K (COM)		\$2,766			\$1,293		
Grade L		\$2,787			\$1,302		
Grade M (COL)		\$2,808			\$1,311		
Grade N		\$2,829			\$1,320		
Grade O		\$2,850			\$1,329		
Grade P		\$2,871			\$1,338		
Grade Q		\$2,892			\$1,347		
Grade R		\$2,913			\$1,356		
Grade S		\$2,934			\$1,365		
Grade T		\$2,955			\$1,374		
Grade U		\$2,976			\$1,383		
U+ Formula (See pg.12)		(# above U) x 21 + 2976			(# above U) x 9 + 1383		
Riser		21			9		
COM (Yards)		6.50			2.75		
COL (sq. ft.)		N/A			N/A		
Leather 1		N/A			N/A		
Leather 2		N/A			N/A		
Leather 3		N/A			N/A		
Leather 4		N/A			N/A		
Leather 5		N/A			N/A		
Leather 6		N/A			N/A		
Leather 8		N/A			N/A		
Standard Seat Cushion		Blendown			High Resiliency 40		
Finish Options		Y			Y		
Nail-head Trim	Small	45	135	45	45	45	45
	Medium	60	N/A	60	60	N/A	60

Style Number		(XXXX)-26			(XXXX)-27		
		Right Arm Facing Chaise			Left Arm Facing Chaise		
		BORDER TRACK ARM CHAMFERED ARM	SMALL TRACK ARM	CLIPPED ARM	BORDER TRACK ARM CHAMFERED ARM	SMALL TRACK ARM	CLIPPED ARM
Overall Dimensions	Width	38.5	33	37.5	38.5	33	37.5
	Depth	72	67	71	72	67	71
	Height	32.5			32.5		
Arm Height		26			26		
Seat Height		19.5			19.5		
Seat Depth		53			53		
Inside Width		30			30		
Standard Blendown Throw Pillow(s)		(1) 18 x 18			(1) 18 x 18		
Wrap , Carton Weight, Cubes		120 , 149 , 70.78			120 , 155 , 70.78		
Grade D		\$3,960			\$3,960		
Grade E		\$4,005			\$4,005		
Grade F		\$4,050			\$4,050		
Grade G		\$4,095			\$4,095		
Grade H		\$4,140			\$4,140		
Grade J		\$4,185			\$4,185		
Grade K (COM)		\$4,230			\$4,230		
Grade L		\$4,275			\$4,275		
Grade M (COL)		\$4,320			\$4,320		
Grade N		\$4,365			\$4,365		
Grade O		\$4,410			\$4,410		
Grade P		\$4,455			\$4,455		
Grade Q		\$4,500			\$4,500		
Grade R		\$4,545			\$4,545		
Grade S		\$4,590			\$4,590		
Grade T		\$4,635			\$4,635		
Grade U		\$4,680			\$4,680		
U+ Formula (See pg.12)		(# above U) x 45 + 4680			(# above U) x 45 + 4680		
Riser		45			45		
COM (Yards)		13.50			13.50		
COL (sq. ft.)		N/A			N/A		
Leather 1		N/A			N/A		
Leather 2		N/A			N/A		
Leather 3		N/A			N/A		
Leather 4		N/A			N/A		
Leather 5		N/A			N/A		
Leather 6		N/A			N/A		
Leather 8		N/A			N/A		
Standard Seat Cushion		Blendown			Blendown		
Finish Options		Y			Y		
Nail-head Trim	Small	75	75	75	75	75	75
	Medium	90	N/A	90	90	N/A	90

Style Number		(XXXX)-29			(XXXX)-31		
		Corner Chair			Swivel Chair		
		BORDER TRACK ARM CHAMFERED ARM	SMALL TRACK ARM	CLIPPED ARM	BORDER TRACK ARM CHAMFERED ARM	SMALL TRACK ARM	CLIPPED ARM
Overall Dimensions	Width	38.5	33	34	38	28	36
	Depth	38.5	33	37.5	38.5	32.5	37.5
	Height	32.5			32.5		
Arm Height		26			26		
Seat Height		19.5			19.5		
Seat Depth		21.5			21.5		
Inside Width		21.5			22		
Standard Blendown Throw Pillow(s)		N/A			N/A		
Wrap , Carton Weight, Cubes		80 , 97 , 36.49			75 , 92 , 36.49		
Grade D		\$2,805			\$2,640		
Grade E		\$2,835			\$2,661		
Grade F		\$2,865			\$2,682		
Grade G		\$2,895			\$2,703		
Grade H		\$2,925			\$2,724		
Grade J		\$2,955			\$2,745		
Grade K (COM)		\$2,985			\$2,766		
Grade L		\$3,015			\$2,787		
Grade M (COL)		\$3,045			\$2,808		
Grade N		\$3,075			\$2,829		
Grade O		\$3,105			\$2,850		
Grade P		\$3,135			\$2,871		
Grade Q		\$3,165			\$2,892		
Grade R		\$3,195			\$2,913		
Grade S		\$3,225			\$2,934		
Grade T		\$3,255			\$2,955		
Grade U		\$3,285			\$2,976		
U+ Formula (See pg.12)		(# above U) x 30 + 3285			(# above U) x 21 + 2976		
Riser		30			21		
COM (Yards)		8.25			6.50		
COL (sq. ft.)		N/A			N/A		
Leather 1		N/A			N/A		
Leather 2		N/A			N/A		
Leather 3		N/A			N/A		
Leather 4		N/A			N/A		
Leather 5		N/A			N/A		
Leather 6		N/A			N/A		
Leather 8		N/A			N/A		
Standard Seat Cushion		Blendown			Blendown		
Finish Options		Y			N		
Nail-head Trim	Small	60	105	60	45	135	45
	Medium	75	N/A	75	60	N/A	60

Style Number		(XXXX)-50			(XXXX)-51		
		Sofa			Right Arm Facing Sofa		
		BORDER TRACK ARM CHAMFERED ARM	SMALL TRACK ARM	CLIPPED ARM	BORDER TRACK ARM CHAMFERED ARM	SMALL TRACK ARM	CLIPPED ARM
Overall Dimensions	Width	85	75	83	76	71	75
	Depth	38.5	33	37.5	38.5	33	37.5
	Height	32.5			32.5		
Arm Height		26			26		
Seat Height		19.5			19.5		
Seat Depth		21.5			21.5		
Inside Width		68			68		
Standard Blendown Throw Pillow(s)		(2) 18 x 18			(1) 18 x 18		
Wrap , Carton Weight, Cubes		139 , 177 , 79.34			109 , 144 , 73.53		
Grade D		\$4,539			\$4,209		
Grade E		\$4,599			\$4,254		
Grade F		\$4,659			\$4,299		
Grade G		\$4,719			\$4,344		
Grade H		\$4,779			\$4,389		
Grade J		\$4,839			\$4,434		
Grade K (COM)		\$4,899			\$4,479		
Grade L		\$4,959			\$4,524		
Grade M (COL)		\$5,019			\$4,569		
Grade N		\$5,079			\$4,614		
Grade O		\$5,139			\$4,659		
Grade P		\$5,199			\$4,704		
Grade Q		\$5,259			\$4,749		
Grade R		\$5,319			\$4,794		
Grade S		\$5,379			\$4,839		
Grade T		\$5,439			\$4,884		
Grade U		\$5,499			\$4,929		
U+ Formula (See pg.12)		(# above U) x 60 + 5499			(# above U) x 45 + 4929		
Riser		60			45		
COM (Yards)		18.75			16.00		
COL (sq. ft.)		N/A			N/A		
Leather 1		N/A			N/A		
Leather 2		N/A			N/A		
Leather 3		N/A			N/A		
Leather 4		N/A			N/A		
Leather 5		N/A			N/A		
Leather 6		N/A			N/A		
Leather 8		N/A			N/A		
Standard Seat Cushion		Blendown			Blendown		
Finish Options		Y			Y		
Nail-head Trim	Small	75	150	75	75	105	75
	Medium	90	N/A	90	90	N/A	90

Style Number		(XXXX)-52			(XXXX)-53		
		Left Arm Facing Sofa			Right Arm Facing Corner Sofa		
		BORDER TRACK ARM CHAMFERED ARM	SMALL TRACK ARM	CLIPPED ARM	BORDER TRACK ARM CHAMFERED ARM	SMALL TRACK ARM	CLIPPED ARM
Overall Dimensions	Width	76	71	75	115	104	113
	Depth	38.5	33	37.5	38.5	33	37.5
	Height	32.5			32.5		
Arm Height		26			26		
Seat Height		19.5			19.5		
Seat Depth		21.5			21.5		
Inside Width		68			89.5		
Standard Blendown Throw Pillow(s)		(1) 18 x 18			(2) 18 x 18		
Wrap , Carton Weight, Cubes		109 , 147 , 73.53			210 , 262 , 112.18		
Grade D		\$4,209			\$5,529		
Grade E		\$4,254			\$5,592		
Grade F		\$4,299			\$5,655		
Grade G		\$4,344			\$5,718		
Grade H		\$4,389			\$5,781		
Grade J		\$4,434			\$5,844		
Grade K (COM)		\$4,479			\$5,907		
Grade L		\$4,524			\$5,970		
Grade M (COL)		\$4,569			\$6,033		
Grade N		\$4,614			\$6,096		
Grade O		\$4,659			\$6,159		
Grade P		\$4,704			\$6,222		
Grade Q		\$4,749			\$6,285		
Grade R		\$4,794			\$6,348		
Grade S		\$4,839			\$6,411		
Grade T		\$4,884			\$6,474		
Grade U		\$4,929			\$6,537		
U+ Formula (See pg.12)		(# above U) x 45 + 4929			(# above U) x 63 + 6537		
Riser		45			63		
COM (Yards)		16.00			22.50		
COL (sq. ft.)		N/A			N/A		
Leather 1		N/A			N/A		
Leather 2		N/A			N/A		
Leather 3		N/A			N/A		
Leather 4		N/A			N/A		
Leather 5		N/A			N/A		
Leather 6		N/A			N/A		
Leather 8		N/A			N/A		
Standard Seat Cushion		Blendown			Blendown		
Finish Options		Y			Y		
Nail-head Trim	Small	75	105	75	210	150	90
	Medium	90	N/A	90	225	N/A	105

Style Number Name		(XXXX)-54			(XXXX)-67		
		Left Arm Facing Corner Sofa			Bumper Ottoman		
		BORDER TRACK ARM CHAMFERED ARM	SMALL TRACK ARM	CLIPPED ARM	BORDER TRACK ARM CHAMFERED ARM	SMALL TRACK ARM	CLIPPED ARM
Overall Dimensions	Width	115	104	113	34		
	Depth	38.5	33	37.5	38.5	33	37.5
	Height	32.5			19.5		
Arm Height		26			N/A		
Seat Height		19.5			N/A		
Seat Depth		21.5			N/A		
Inside Width		89.5			N/A		
Standard Blendown Throw Pillow(s)		(2) 18 x 18			N/A		
Wrap , Carton Weight, Cubes		210 , 265 , 83.27			55 , 70 , 14.77		
Grade D		\$5,529			\$2,031		
Grade E		\$5,592			\$2,052		
Grade F		\$5,655			\$2,073		
Grade G		\$5,718			\$2,094		
Grade H		\$5,781			\$2,115		
Grade J		\$5,844			\$2,136		
Grade K (COM)		\$5,907			\$2,157		
Grade L		\$5,970			\$2,178		
Grade M (COL)		\$6,033			\$2,199		
Grade N		\$6,096			\$2,220		
Grade O		\$6,159			\$2,241		
Grade P		\$6,222			\$2,262		
Grade Q		\$6,285			\$2,283		
Grade R		\$6,348			\$2,304		
Grade S		\$6,411			\$2,325		
Grade T		\$6,474			\$2,346		
Grade U		\$6,537			\$2,367		
U+ Formula (See pg.12)		(# above U) x 63 + 6537			(# above U) x 21 + 2367		
Riser		63			21		
COM (Yards)		22.50			6.75		
COL (sq. ft.)		N/A			N/A		
Leather 1		N/A			N/A		
Leather 2		N/A			N/A		
Leather 3		N/A			N/A		
Leather 4		N/A			N/A		
Leather 5		N/A			N/A		
Leather 6		N/A			N/A		
Leather 8		N/A			N/A		
Standard Seat Cushion		Blendown			Blendown		
Finish Options		Y			Y		
Nail-head Trim	Small	210	150	90	60	60	60
	Medium	225	N/A	105	75	N/A	75

Style Number		(XXXX)-75			(XXXX)-76		
		Right Arm Facing Cuddle Chaise			Left Arm Facing Cuddle Chaise		
		BORDER TRACK ARM ----- CHAMFERED ARM	SMALL TRACK ARM	CLIPPED ARM	BORDER TRACK ARM ----- CHAMFERED ARM	SMALL TRACK ARM	CLIPPED ARM
Overall Dimensions	Width	38.5	33	37.5	38.5	33	37.5
	Depth	95.5	90	94.5	95.5	90	94.5
	Height	32.5			32.5		
Arm Height		26			26		
Seat Height		19.5			19.5		
Seat Depth		78			78		
Inside Width		21.5			21.5		
Standard Blendown Throw Pillow(s)		(1) 18 x 18			(1) 18 x 18		
Wrap , Carton Weight, Cubes		99 , 141 , 82.92			125 , 170 , 69.15		
Grade D		\$4,605			\$4,605		
Grade E		\$4,659			\$4,659		
Grade F		\$4,713			\$4,713		
Grade G		\$4,767			\$4,767		
Grade H		\$4,821			\$4,821		
Grade J		\$4,875			\$4,875		
Grade K (COM)		\$4,929			\$4,929		
Grade L		\$4,983			\$4,983		
Grade M (COL)		\$5,037			\$5,037		
Grade N		\$5,091			\$5,091		
Grade O		\$5,145			\$5,145		
Grade P		\$5,199			\$5,199		
Grade Q		\$5,253			\$5,253		
Grade R		\$5,307			\$5,307		
Grade S		\$5,361			\$5,361		
Grade T		\$5,415			\$5,415		
Grade U		\$5,469			\$5,469		
U+ Formula (See pg.12)		(# above U) x 54 + 5469			(# above U) x 54 + 5469		
Riser		54			54		
COM (Yards)		18.00			18.00		
COL (sq. ft.)		N/A			N/A		
Leather 1		N/A			N/A		
Leather 2		N/A			N/A		
Leather 3		N/A			N/A		
Leather 4		N/A			N/A		
Leather 5		N/A			N/A		
Leather 6		N/A			N/A		
Leather 8		N/A			N/A		
Standard Seat Cushion		Blendown			Blendown		
Finish Options		Y			Y		
Nail-head Trim	Small	210	150	90	210	150	90
	Medium	225	N/A	105	225	N/A	105

Style Number		(XXXX)-78			(XXXXP)-QS		
		Name			Name		
		Armless Chair			Queen Sleeper		
		BORDER TRACK ARM CHAMFERED ARM	SMALL TRACK ARM	CLIPPED ARM	BORDER TRACK ARM CHAMFERED ARM	SMALL TRACK ARM	CLIPPED ARM
Overall Dimensions	Width	34	34	34	94.75	84	92.75
	Depth	38.5	33	37.5	39.75	36.5	38
	Height	32.5			32		
Arm Height		N/A			25.5		
Seat Height		19.5			17.5		
Seat Depth		21.5			23		
Inside Width		34			79		
Standard Blendown Throw Pillow(s)		N/A			(2) 18 x 18		
Wrap , Carton Weight, Cubes		65 , 82 , 36.49			253 , 297 , 82.92		
Grade D		\$2,559			\$6,105		
Grade E		\$2,589			\$6,153		
Grade F		\$2,619			\$6,201		
Grade G		\$2,649			\$6,249		
Grade H		\$2,679			\$6,297		
Grade J		\$2,709			\$6,345		
Grade K (COM)		\$2,739			\$6,393		
Grade L		\$2,769			\$6,441		
Grade M (COL)		\$2,799			\$6,489		
Grade N		\$2,829			\$6,537		
Grade O		\$2,859			\$6,585		
Grade P		\$2,889			\$6,633		
Grade Q		\$2,919			\$6,681		
Grade R		\$2,949			\$6,729		
Grade S		\$2,979			\$6,777		
Grade T		\$3,009			\$6,825		
Grade U		\$3,039			\$6,873		
U+ Formula (See pg.12)		# above U) x 30 + 3039			# above U) x 48 + 6873		
Riser		30			48		
COM (Yards)		8.25			17.75		
COL (sq. ft.)		N/A			N/A		
Leather 1		N/A			N/A		
Leather 2		N/A			N/A		
Leather 3		N/A			N/A		
Leather 4		N/A			N/A		
Leather 5		N/A			N/A		
Leather 6		N/A			N/A		
Leather 8		N/A			N/A		
Standard Seat Cushion		Blendown			High Resiliency 35		
Finish Options		Y			N		
Nail-head Trim	Small	60	45	60	210	210	210
	Medium	75	N/A	75	N/A	N/A	N/A

Throw Pillows

FB46-00

Channelled Bolster

Width: 46 **Depth:** 7 **Height:** 15

Weight: 5 / 5 lbs **Cube:** 2.79

Standard Filling: Blown Fiber Filling **COM:** 3.75 yards

D	E	F	G	H	J	K _{COM}	L	M	N	O	P	Q	R	S	T	U	(# above U) *
420	420	420	420	420	435	435	435	435	435	465	465	465	465	465	510	510	12 (Riser) + 510 (U)

FB60-00

Channelled Bolster

Width: 60 **Depth:** 7 **Height:** 15

Weight: 8 / 8 lbs **Cube:** 3.64

Standard Filling: Blown Fiber Filling **COM:** 4.75 yards

D	E	F	G	H	J	K _{COM}	L	M	N	O	P	Q	R	S	T	U	(# above U) *
495	495	495	495	495	525	525	525	525	525	585	585	585	585	585	630	630	15 (Riser) + 630 (U)

FF46-00

Bolster

Width: 46 **Depth:** 2 **Height:** 14

Weight: 5 / 5 lbs **Cube:** 0.74

Standard Filling: Blown Fiber Filling **COM:** 1.5 yards

D	E	F	G	H	J	K _{COM}	L	M	N	O	P	Q	R	S	T	U	(# above U) *
315	315	315	315	315	330	330	330	330	330	345	345	345	345	345	375	375	9 (Riser) + 375 (U)

FF60-00

Bolster

Width: 60 **Depth:** 2 **Height:** 14

Weight: 8 / 8 lbs **Cube:** 0.97

Standard Filling: Blown Fiber Filling **COM:** 2 yards

D	E	F	G	H	J	K _{COM}	L	M	N	O	P	Q	R	S	T	U	(# above U) *
360	360	360	360	360	375	375	375	375	375	390	390	390	390	390	420	420	9 (Riser) + 420 (U)

OR12-BD

Sphere Pillow

with Blendown Filling

Width: 12 **Depth:** 12 **Height:** 12

Weight: 2 / 2 lbs **Cube:** 1

Standard Filling: Blendown **COM:** 1.25 yards

D	E	F	G	H	J	K _{COM}	L	M	N	O	P	Q	R	S	T	U	(# above U) *
225	225	225	225	225	240	240	240	240	240	255	255	255	255	255	270	270	3 (Riser) + 270 (U)

OR12-00

Sphere Pillow

with Fiber Filling

Width: 12 **Depth:** 12 **Height:** 12

Weight: 2 / 2 lbs **Cube:** 1

Standard Filling: Blown Fiber Filling **COM:** 1.25 yards

D	E	F	G	H	J	K _{COM}	L	M	N	O	P	Q	R	S	T	U	(# above U) *
195	195	195	195	195	210	210	210	210	210	225	225	225	225	225	240	240	3 (Riser) + 240 (U)

0012-BD

Round Welled Border Pillow

Blendown Filling

Width: 14.5 **Depth:** 6 **Height:** 0

Weight: 2 / 2 lbs **Cube:** 0

Standard Filling: Blendown **COM:** 1.5 yards

D	E	F	G	H	J	K _{COM}	L	M	N	O	P	Q	R	S	T	U	(# above U) *
210	210	210	210	210	225	225	225	225	225	240	240	240	240	240	255	255	6 (Riser) + 255 (U)

Throw Pillows

0012-00

Round Welted Border Pillow

Blown Fiber Filling

Width: 14.5 **Depth:** 6 **Height:** 0

Weight: 2 / 0 lbs **Cube:** 0

Standard Filling: Blown Fiber Filling **COM:** 1.5 yards

D	E	F	G	H	J	K _{COM}	L	M	N	O	P	Q	R	S	T	U	(# above U) *
195	195	195	195	195	210	210	210	210	210	225	225	225	225	225	255	255	6 (Riser) + 255 (U)

0013-BD

Round Welted Border Pillow with buttons

Blendown Filling

Width: 14.5 **Depth:** 6 **Height:** 0

Weight: 2 / 2 lbs **Cube:** 0

Standard Filling: Blendown **COM:** 1.5 yards

D	E	F	G	H	J	K _{COM}	L	M	N	O	P	Q	R	S	T	U	(# above U) *
225	225	225	225	225	240	240	240	240	240	255	255	255	255	255	270	270	6 (Riser) + 270 (U)

0013-00

Round Welted Border Pillow with buttons

Blown Fiber Filling

Width: 14.5 **Depth:** 6 **Height:** 0

Weight: 2 / 2 lbs **Cube:** 0

Standard Filling: Blown Fiber Filling **COM:** 1.5 yards

D	E	F	G	H	J	K _{COM}	L	M	N	O	P	Q	R	S	T	U	(# above U) *
195	195	195	195	195	210	210	210	210	210	225	225	225	225	225	240	240	6 (Riser) + 240 (U)

0014-BD

Welted Square Pillow

Width: 14 **Depth:** 4 **Height:** 14

Weight: 5 / 5 lbs **Cube:** 0.45

Standard Filling: Blendown **COM:** 1 yards

D	E	F	G	H	J	K _{COM}	L	M	N	O	P	Q	R	S	T	U	(# above U) *
180	180	180	180	180	195	195	195	195	195	210	210	210	210	210	240	240	3 (Riser) + 240 (U)

0014-00

Welted Square Pillow

Width: 14 **Depth:** 4 **Height:** 14

Weight: 5 / 5 lbs **Cube:** 0.45

Standard Filling: Blown Fiber Filling **COM:** 1 yards

D	E	F	G	H	J	K _{COM}	L	M	N	O	P	Q	R	S	T	U	(# above U) *
150	150	150	150	150	165	165	165	165	165	180	180	180	180	180	210	210	3 (Riser) + 210 (U)

0016-BD

Welted Square Pillow

Width: 16 **Depth:** 5 **Height:** 16

Weight: 5 / 5 lbs **Cube:** 0.74

Standard Filling: Blendown **COM:** 1.25 yards

D	E	F	G	H	J	K _{COM}	L	M	N	O	P	Q	R	S	T	U	(# above U) *
180	180	180	180	180	195	195	195	195	195	210	210	210	210	210	240	240	6 (Riser) + 240 (U)

0016-00

Welted Square Pillow

Width: 16 **Depth:** 5 **Height:** 16

Weight: 5 / 5 lbs **Cube:** 0.74

Standard Filling: Blown Fiber Filling **COM:** 1.25 yards

D	E	F	G	H	J	K _{COM}	L	M	N	O	P	Q	R	S	T	U	(# above U) *
150	150	150	150	150	165	165	165	165	165	180	180	180	180	180	210	210	6 (Riser) + 210 (U)

Throw Pillows

0018-BD

Wetted Square Pillow

Width: 18 Depth: 6 Height: 18

Weight: 2 / 2 lbs Cube: 1.12

Standard Filling: Blendown COM: 1.25 yards

D	E	F	G	H	J	K _{COM}	L	M	N	O	P	Q	R	S	T	U	(# above U) *
195	195	195	195	195	210	210	210	210	210	225	225	225	225	225	255	255	6 (Riser) + 255 (U)

0018-00

Wetted Square Pillow

Width: 18 Depth: 6 Height: 18

Weight: 2 / 2 lbs Cube: 1.12

Standard Filling: Blown Fiber Filling COM: 1.25 yards

D	E	F	G	H	J	K _{COM}	L	M	N	O	P	Q	R	S	T	U	(# above U) *
165	165	165	165	165	180	180	180	180	180	195	195	195	195	195	225	225	6 (Riser) + 225 (U)

0020-BD

Wetted Square Pillow

Width: 20 Depth: 6 Height: 20

Weight: 5 / 5 lbs Cube: 1.38

Standard Filling: Blendown COM: 1.25 yards

D	E	F	G	H	J	K _{COM}	L	M	N	O	P	Q	R	S	T	U	(# above U) *
210	210	210	210	210	225	225	225	225	225	240	240	240	240	240	270	270	6 (Riser) + 270 (U)

0020-00

Wetted Square Pillow

Width: 20 Depth: 6 Height: 20

Weight: 5 / 5 lbs Cube: 1.38

Standard Filling: Blown Fiber Filling COM: 1.25 yards

D	E	F	G	H	J	K _{COM}	L	M	N	O	P	Q	R	S	T	U	(# above U) *
180	180	180	180	180	195	195	195	195	195	210	210	210	210	210	240	240	6 (Riser) + 240 (U)

0022-BD

Wetted Square Pillow

Width: 22 Depth: 6 Height: 22

Weight: 5 / 5 lbs Cube: 1.68

Standard Filling: Blendown COM: 1.5 yards

D	E	F	G	H	J	K _{COM}	L	M	N	O	P	Q	R	S	T	U	(# above U) *
225	225	225	225	225	240	240	240	240	240	255	255	255	255	255	300	300	6 (Riser) + 300 (U)

0022-00

Wetted Square Pillow

Width: 22 Depth: 6 Height: 22

Weight: 5 / 5 lbs Cube: 1.68

Standard Filling: Blown Fiber Filling COM: 1.5 yards

D	E	F	G	H	J	K _{COM}	L	M	N	O	P	Q	R	S	T	U	(# above U) *
195	195	195	195	195	210	210	210	210	210	225	225	225	225	225	270	270	6 (Riser) + 270 (U)

0024-BD

Wetted Square Pillow

Width: 24 Depth: 0 Height: 24

Weight: 5 / 5 lbs Cube: 0

Standard Filling: Blendown COM: 1.5 yards

D	E	F	G	H	J	K _{COM}	L	M	N	O	P	Q	R	S	T	U	(# above U) *
240	240	240	240	240	255	255	255	255	255	270	270	270	270	270	300	300	6 (Riser) + 300 (U)

Throw Pillows

0024-00

Wetted Square Pillow

Width: 24 Depth: 0 Height: 24

Weight: 5 / 5 lbs Cube: 0

Standard Filling: Blown Fiber Filling COM: 1.5 yards

D	E	F	G	H	J	K _{COM}	L	M	N	O	P	Q	R	S	T	U	(# above U) *
210	210	210	210	210	225	225	225	225	225	240	240	240	240	240	270	270	6 (Riser) + 270 (U)

0066-BD

Wetted Kidney Pillow

Width: 22 Depth: 0 Height: 11

Weight: 5 / 5 lbs Cube: 0

Standard Filling: Blendown COM: 1.5 yards

D	E	F	G	H	J	K _{COM}	L	M	N	O	P	Q	R	S	T	U	(# above U) *
195	195	195	195	195	210	210	210	210	210	225	225	225	225	225	255	255	6 (Riser) + 255 (U)

0066-00

Wetted Kidney Pillow

Width: 22 Depth: 0 Height: 11

Weight: 5 / 5 lbs Cube: 0

Standard Filling: Blown Fiber Filling COM: 1.5 yards

D	E	F	G	H	J	K _{COM}	L	M	N	O	P	Q	R	S	T	U	(# above U) *
165	165	165	165	165	180	180	180	180	180	195	195	195	195	195	225	225	6 (Riser) + 225 (U)

0077-BD

Wetted Kidney Pillow

Width: 16 Depth: 0 Height: 11

Weight: 5 / 5 lbs Cube: 0

Standard Filling: Blendown COM: 1.25 yards

D	E	F	G	H	J	K _{COM}	L	M	N	O	P	Q	R	S	T	U	(# above U) *
180	180	180	180	180	195	195	195	195	195	210	210	210	210	210	225	225	3 (Riser) + 225 (U)

0077-00

Wetted Kidney Pillow

Width: 16 Depth: 0 Height: 11

Weight: 5 / 5 lbs Cube: 0

Standard Filling: Blown Fiber Filling COM: 1.25 yards

D	E	F	G	H	J	K _{COM}	L	M	N	O	P	Q	R	S	T	U	(# above U) *
150	150	150	150	150	165	165	165	165	165	180	180	180	180	180	195	195	3 (Riser) + 195 (U)

0079-BD

Wetted Kidney Pillow

Width: 16 Depth: 0 Height: 9

Weight: 5 / 5 lbs Cube: 0

Standard Filling: Blendown COM: 1.25 yards

D	E	F	G	H	J	K _{COM}	L	M	N	O	P	Q	R	S	T	U	(# above U) *
180	180	180	180	180	195	195	195	195	195	210	210	210	210	210	240	240	3 (Riser) + 240 (U)

0079-00

Wetted Kidney Pillow

Width: 16 Depth: 0 Height: 9

Weight: 5 / 5 lbs Cube: 0

Standard Filling: Blown Fiber Filling COM: 1.25 yards

D	E	F	G	H	J	K _{COM}	L	M	N	O	P	Q	R	S	T	U	(# above U) *
150	150	150	150	150	165	165	165	165	165	180	180	180	180	180	210	210	3 (Riser) + 210 (U)

Throw Pillows

0114-BD

Weltd Square Mitered Pillow

Width: 14 Depth: 0 Height: 14

Weight: 5 / 5 lbs Cube: 0

Standard Filling: Blendown COM: 1.5 yards

D	E	F	G	H	J	K _{COM}	L	M	N	O	P	Q	R	S	T	U	(# above U) *
225	225	225	225	225	240	240	240	240	240	255	255	255	255	255	300	300	6 (Riser) + 300 (U)

0114-00

Weltd Square Mitered Pillow

Width: 14 Depth: 4 Height: 14

Weight: 5 / 5 lbs Cube: 0.45

Standard Filling: Blown Fiber Filling COM: 1.5 yards

D	E	F	G	H	J	K _{COM}	L	M	N	O	P	Q	R	S	T	U	(# above U) *
195	195	195	195	195	210	210	210	210	210	225	225	225	225	225	270	270	6 (Riser) + 270 (U)

0116-BD

Weltd Square Mitered Pillow

Width: 16 Depth: 5 Height: 16

Weight: 5 / 5 lbs Cube: 0.74

Standard Filling: Blendown COM: 1.75 yards

D	E	F	G	H	J	K _{COM}	L	M	N	O	P	Q	R	S	T	U	(# above U) *
225	225	225	225	225	240	240	240	240	240	255	255	255	255	255	300	300	6 (Riser) + 300 (U)

0116-00

Weltd Square Mitered Pillow

Width: 16 Depth: 5 Height: 16

Weight: 5 / 5 lbs Cube: 0.74

Standard Filling: Blown Fiber Filling COM: 1.75 yards

D	E	F	G	H	J	K _{COM}	L	M	N	O	P	Q	R	S	T	U	(# above U) *
195	195	195	195	195	210	210	210	210	210	225	225	225	225	225	270	270	6 (Riser) + 270 (U)

0118-BD

Weltd Square Mitered Pillow

Width: 18 Depth: 0 Height: 18

Weight: 5 / 5 lbs Cube: 0

Standard Filling: Blendown COM: 1.75 yards

D	E	F	G	H	J	K _{COM}	L	M	N	O	P	Q	R	S	T	U	(# above U) *
240	240	240	240	240	255	255	255	255	255	270	270	270	270	270	300	300	6 (Riser) + 300 (U)

0118-00

Weltd Square Mitered Pillow

Width: 18 Depth: 0 Height: 18

Weight: 5 / 5 lbs Cube: 0

Standard Filling: Blown Fiber Filling COM: 1.75 yards

D	E	F	G	H	J	K _{COM}	L	M	N	O	P	Q	R	S	T	U	(# above U) *
210	210	210	210	210	225	225	225	225	225	240	240	240	240	240	270	270	6 (Riser) + 270 (U)

0120-BD

Weltd Square Mitered Pillow

Width: 20 Depth: 0 Height: 20

Weight: 5 / 5 lbs Cube: 0

Standard Filling: Blendown COM: 1.75 yards

D	E	F	G	H	J	K _{COM}	L	M	N	O	P	Q	R	S	T	U	(# above U) *
255	255	255	255	255	270	270	270	270	270	285	285	285	285	285	315	315	6 (Riser) + 315 (U)

Throw Pillows

0120-00

Weltd Square Mitered Pillow

Width: 20 Depth: 0 Height: 20

Weight: 5 / 5 lbs Cube: 0

Standard Filling: Blown Fiber Filling COM: 1.75 yards

D	E	F	G	H	J	K _{COM}	L	M	N	O	P	Q	R	S	T	U	(# above U) *
225	225	225	225	225	240	240	240	240	240	255	255	255	255	255	285	285	6 (Riser) + 285 (U)

0122-BD

Weltd Square Mitered Pillow

Width: 22 Depth: 0 Height: 22

Weight: 5 / 5 lbs Cube: 0

Standard Filling: Blendown COM: 2 yards

D	E	F	G	H	J	K _{COM}	L	M	N	O	P	Q	R	S	T	U	(# above U) *
270	270	270	270	270	285	285	285	285	285	300	300	300	300	300	330	330	6 (Riser) + 330 (U)

0122-00

Weltd Square Mitered Pillow

Width: 22 Depth: 0 Height: 22

Weight: 5 / 5 lbs Cube: 0

Standard Filling: Blown Fiber Filling COM: 2 yards

D	E	F	G	H	J	K _{COM}	L	M	N	O	P	Q	R	S	T	U	(# above U) *
240	240	240	240	240	255	255	255	255	255	270	270	270	270	270	300	300	6 (Riser) + 300 (U)

0124-BD

Weltd Square Mitered Pillow

Width: 24 Depth: 0 Height: 24

Weight: 5 / 5 lbs Cube: 0

Standard Filling: Blendown COM: 2.25 yards

D	E	F	G	H	J	K _{COM}	L	M	N	O	P	Q	R	S	T	U	(# above U) *
285	285	285	285	285	300	300	300	300	300	315	315	315	315	315	345	345	9 (Riser) + 345 (U)

0124-00

Weltd Square Mitered Pillow

Width: 24 Depth: 0 Height: 24

Weight: 5 / 5 lbs Cube: 0

Standard Filling: Blown Fiber Filling COM: 2.25 yards

D	E	F	G	H	J	K _{COM}	L	M	N	O	P	Q	R	S	T	U	(# above U) *
255	255	255	255	255	270	270	270	270	270	285	285	285	285	285	315	315	9 (Riser) + 315 (U)

COLOR BLOCK ACCENT THROW PILLOWS

Made to Ship Within 1-2 Weeks



Introducing our Color Block Accent Throw Pillows,

the perfect way to add a pop of vibrant color to any space! Crafted from luxurious soft velvets, linens, and leathers, these pillows are not only visually stunning but also incredibly comfortable. With their unique color block design, they effortlessly bring a modern and stylish touch to your home decor. Elevate your living room, bedroom, or office with these eye-catching accents that are sure to impress your guests.



Velvet Channel Color Block Throw Pillows

TP01-01 - 20" x 20"

Blocks of deep, plush color to soften the look of your living room, family room, bedroom. Our Color block Linen Throw Pillows are made of 100% linen, wrapped with our most popular lush velvet.

\$177_{MSRP}

Weltless | 80/20 Blendown Inserts | Hidden Zipper

MADE TO SHIP
within
1-2 WEEKS



TP01-01-A Zucchini
3506 Putty on Back and
Outer Channel,
4787 Zucchini Middle Stripe



TP01-01-B Emerald
3506 Putty on Back and
Outer Channel,
- 4787 Emerald Middle Stripe



TP01-01-C Denim
3506 Putty on Back and
Outer Channel,
4787 Denim Middle Stripe



TP01-01-D Heron
3506 Putty on Back and
Outer Channel,
4787 Heron Middle Stripe



TP01-01-E Smoke
3506 Putty on Back and
Outer Channel,
4787 Smoke Middle Stripe



TP01-01-F Flannel
3506 Putty on Back and
Outer Channel,
4787 Flannel Middle Stripe



TP01-01-G Mink
3506 Putty on Back and
Outer Channel,
4787 Mink Middle Stripe



TP01-01-H Organza
3506 Putty on Back and
Outer Channel,
4787 Organza Middle Stripe



TP01-01-I Lagoon
3506 Putty on Back and
Outer Channel,
4787 Lagoon Middle Stripe



TP01-01-J Quince
3506 Putty on Back and
Outer Channel,
4787 Quince Middle Stripe



TP01-01-K Blossom
3506 Putty on Back and
Outer Channel,
4787 Blossom Middle Stripe

Velvet Offset Color Block Throw Pillows

TP02-01 - 20" x 20"

Blocks of deep, plush color to soften the look of your living room, family room, bedroom.
Our Color block Linen Throw Pillows are made of 100% linen, wrapped with our most popular lush velvet.

MADE TO SHIP
within
1-2 WEEKS

\$195 MSRP

Weltless | 80/20 Blendown Inserts | Hidden Zipper



TP02-01-A Zucchini
3506 Putty on Back and
Smaller Channel,
4787 Zucchini Large Block



TP02-01-B Emerald
3506 Putty on Back and
Smaller Channel,
4787 Emerald Large Block



TP02-01-C Denim
3506 Putty on Back and
Smaller Channel,
4787 Denim Large Block



TP02-01-D Heron
3506 Putty on Back and
Smaller Channel,
4787 Heron Large Block



TP02-01-E Smoke
3506 Putty on Back and
Smaller Channel,
4787 Smoke Large Block



TP02-01-F Flannel
3506 Putty on Back and
Smaller Channel,
4787 Flannel Large Block



TP01-02-G Mink
3506 Putty on Back and
Smaller Channel,
4787 Mink Large Block



TP01-02-H Organza
3506 Putty on Back and
Smaller Channel,
4787 Organza Large Block



TP02-01-I Lagoon
3506 Putty on Back and
Smaller Channel,
4787 Lagoon Large Block



TP02-01-J Quince
3506 Putty on Back and
Smaller Channel,
4787 Quince Large Block



TP02-01-K Blossom
3506 Putty on Back and
Smaller Channel,
4787 Blossom Large Block

Velvet Stripe Color Block Kidney Pillows

TP03-01 - 13" x 22"

Blocks of deep, plush color to soften the look of your living room, family room, bedroom.
Our Color block Linen Throw Pillows are made of 100% linen, wrapped with our most popular lush velvet.

\$186 MSRP

Weltless | 80/20 Blendown Inserts | Hidden Zipper

MADE TO SHIP
within
1-2 WEEKS



TP03-01-A Zucchini
3506 Putty on Back and
Outer Channel,
4787 Zucchini Middle Stripe



TP03-01-B Emerald
3506 Putty on Back and
Outer Channel,
4787 Emerald Middle Stripe



TP03-01-C Denim
3506 Putty on Back and
Outer Channel,
4787 Denim Middle Stripe



TP03-01-D Heron
3506 Putty on Back and
Outer Channel,
4787 Heron Middle Stripe



TP03-01-E Smoke
3506 Putty on Back and
Outer Channel,
4787 Smoke Middle Stripe



TP03-01-F Flannel
3506 Putty on Back and
Outer Channel,
4787 Flannel Middle Stripe



TP03-01-G Mink
3506 Putty on Back and
Outer Channel,
4787 Mink Middle Stripe



TP03-01-H Organza
3506 Putty on Back and
Outer Channel,
4787 Organza Middle Stripe



TP03-01-I Lagoon
3506 Putty on Back and
Outer Channel,
4787 Lagoon Middle Stripe

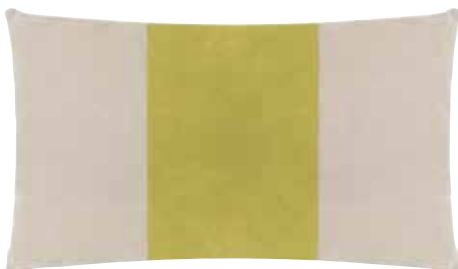

TP03-01-J Quince
3506 Putty on Back and
Outer Channel,
4787 Quince Middle Stripe



TP03-01-K Blossom
3506 Putty on Back and
Outer Channel,
4787 Blossom Middle Stripe

Lincoln Channel Color Block Throw Pillows

TP04-01 - 20" x 20"

Our Linen Color Block throw pillows are made of 100% linen.

Weltless | 80/20 Blendown Inserts | Hidden Zipper

MADE TO SHIP
within
1-2 WEEKS

\$165 MSRP



TP04-01-A Metal
3506 Dune on Back and
Outer Channels,
3506 Metal Middle Stripe



TP04-01-B Denim
3506 Dune on Back and
Outer Channels,
3506 Denim Middle Stripe



TP04-01-C Mushroom
3506 Dune on Back and
Outer Channels,
3506 Mushroom Middle Stripe



TP04-01-D Terracotta
3506 Dune on Back and
Outer Channels,
3506 Terracotta Middle Stripe



TP04-01-E Cream
3506 Dune on Back and
Outer Channels,
3506 Cream Middle Stripe

Linens Offset Color Block Throw Pillows & Kidneys

TP05-01 - 20" x 20"

Our Linens Color Block throw pillows are made of 100% linen.

Weltless | 80/20 Blendown Inserts | Hidden Zipper

MADE TO SHIP
within
1-2 WEEKS

\$180 MSRP



TP05-01-A Metal
3506 Dune on Back and
Small Channel,
3506 Metal



TP05-01-B Denim
3506 Dune on Back and
Small Channel,
3506 Denim



TP05-01-C Mushroom
3506 Dune on Back and
Small Channel,
3506 Mushroom



TP05-01-D Terracotta
3506 Dune on Back and
Small Channel,
3506 Terracotta



TP05-01-E Cream
3506 Dune on Back and
Small Channel,
3506 Cream

Linen Stripe Color Block Kidney Pillows

TP06-01 - 13" x 22"

Our Linen Color Block throw pillows are made of 100% linen.

Weltless | 80/20 Blendown Inserts | Hidden Zipper

MADE TO SHIP
within
1-2 WEEKS

\$180 MSRP



TP06-01-A Metal
3506 Dune on Back and
Outer Channels,
3506 Metal Middle Stripe



TP06-01-B Denim
3506 Dune on Back and
Outer Channels,
3506 Denim Middle Stripe



TP06-01-C Mushroom
3506 Dune on Back and
Outer Channels,
3506 Mushroom Middle Stripe



TP06-01-D Terracotta
3506 Dune on Back and
Outer Channels,
3506 Terracotta Middle Stripe



TP06-01-E Cream
3506 Dune on Back and
Outer Channels,
3506 Cream Middle Stripe

Modern Ensemble Pillows in Leather, Linen & Velvet

TP07-01 - 20" x 20" — TP08-01 - 13" x 22"

Our Color block Linen Throw Pillows are made of 100% linen, wrapped with our most popular lush velvet. To emphasize more of a modern look we added our Top grain fully aniline leather block for style and superior look.

MADE TO SHIP
within
1-2 WEEKS

\$210 MSRP

Weltless | 80/20 Blendown Inserts | Hidden Zipper



TP07-01-A Denim

3506 Denim - Bottom Channel (linen), 3506 Putty Back (linen), 1125 Iron (leather), 4787 Organza Top Channel (velvet)



TP07-01-B Toffee

3506 Cream - Bottom Channel and Back (linen), 1102 Grey (leather), 4787 Toffee Top Channel (velvet)



TP07-01-C Zucchini

3506 Dune - Bottom Channel and Back (linen), 1125 Dove (leather), 4787 Zucchini Top Channel (velvet)



TP08-01-A Denim

3506 Denim Top Channel and Back in (linen), 3506 Putty Back (linen), 1125 Iron (leather), 4787 Organza Bottom Channel (velvet)



TP08-01-B Toffee

3506 Cream on Top Channel and Back (linen), 1102 Grey (leather), 4787 Toffee Bottom Channel (velvet)



TP08-01-C Zucchini

3506 Dune on Top Channel and Back (linen), 1125 Dove (leather), 4787 Zucchini Bottom Channel (velvet)

Modern Linen Stripe Color Block Throw Pillows

TP09-01 - 20" x 20"

Our Linen Color Block throw pillows are made of 100% linen.

Weltless | 80/20 Blendown Inserts | Hidden Zipper

MADE TO SHIP
within
1-2 WEEKS

\$180 MSRP



TP09-01-A
(1) 3506 Metal
(2) 3506 Denim



TP09-01-B
(1) 3506 Cream
(2) 3506 Terracotta



TP09-01-C
(1) 3506 Cream
(2) 3506 Dune

Textured Embroidery Throw Pillows

TP10-01 - 22" x 22"

Weltless | 80/20 Blendown Inserts | Hidden Zipper

MADE TO SHIP
within
1-2 WEEKS

\$165 MSRP



TP10-01-A
Zara Natural



TP10-01-B
Zara Black

Upholstery

**Pillows are not available on leather SKUs*

Fabric SKU: 1002-01

Leather SKU: N/A

Standard Pillows: N/A Finish Req: Y

Standard Cushions: High Resiliency 40 Standard Finish:

COM: 4.25 yards COL: N/A

Chico Lounge Chair

Width: 29 Depth: 31.5 Height: 34.5

AH: 25.5 SH: 19 SD: 20.5 IW: 23

Weight: 40 lbs Cube: 18.23

D	E	F	G	H	J	K COM	L	M	N	O	P	Q	R	S	T	U	(# above U) *	S Nail	M Nail
1875	1887	1899	1911	1923	1935	1947	1959	1971	1983	1995	2007	2019	2031	2043	2055	2067	12 (Riser) + 2067 (U)	105	N/A
Leather 1 N/A		Leather 2 N/A		Leather 3 N/A		Leather 4 N/A		Leather 5 N/A		Leather 6 N/A		Leather 8 N/A		COL N/A		S Nail N/A		M Nail N/A	

Fabric SKU: 1003-01

Leather SKU: L-1003-01

Standard Pillows: N/A Finish Req: Y

Standard Cushions: High Resiliency 40 Standard Finish:

COM: 3.75 yards COL: 68 square feet

Blythe Lounge Chair

Width: 31 Depth: 32 Height: 35

AH: 24 SH: 19 SD: 21 IW: 23

Weight: 33 lbs Cube: 20.09

D	E	F	G	H	J	K COM	L	M	N	O	P	Q	R	S	T	U	(# above U) *	S Nail	M Nail
1650	1662	1674	1686	1698	1710	1722	1734	1746	1758	1770	1782	1794	1806	1818	1830	1842	12 (Riser) + 1842 (U)	90	N/A
Leather 1 2475		Leather 2 2580		Leather 3 2685		Leather 4 2790		Leather 5 2895		Leather 6 3000		Leather 8 3945		COL 1746		S Nail 90		M Nail N/A	

Fabric SKU: 1004-01

Leather SKU: L-1004-01

Standard Pillows: N/A Finish Req: N

Standard Cushions: Classic Plush Standard Finish:

COM: 10 yards COL: 141 square feet

Vail Lounge Chair

Width: 32.25 Depth: 39.5 Height: 32.5

AH: 25 SH: 19 SD: 22 IW: 25.5

Weight: 80 lbs Cube: 23.95

D	E	F	G	H	J	K COM	L	M	N	O	P	Q	R	S	T	U	(# above U) *	S Nail	M Nail
2385	2415	2445	2475	2505	2535	2565	2595	2625	2655	2685	2715	2745	2775	2805	2835	2865	30 (Riser) + 2865 (U)	90	N/A
Leather 1 4050		Leather 2 4260		Leather 3 4470		Leather 4 4680		Leather 5 4890		Leather 6 5100		Leather 8 7050		COL 2625		S Nail 90		M Nail N/A	

Fabric SKU: 1004-31

Leather SKU: L-1004-31

Standard Pillows: N/A Finish Req: N

Standard Cushions: Classic Plush Standard Finish:

COM: 10 yards COL: 141 square feet

Vail Swivel Chair

Width: 32.25 Depth: 39.5 Height: 32.5

AH: 25 SH: 19 SD: 22 IW: 25.5

Weight: 90 lbs Cube: 36.49

D	E	F	G	H	J	K COM	L	M	N	O	P	Q	R	S	T	U	(# above U) *	S Nail	M Nail
2460	2490	2520	2550	2580	2610	2640	2670	2700	2730	2760	2790	2820	2850	2880	2910	2940	30 (Riser) + 2940 (U)	90	N/A
Leather 1 4125		Leather 2 4335		Leather 3 4545		Leather 4 4755		Leather 5 4965		Leather 6 5175		Leather 8 7125		COL 2700		S Nail 90		M Nail N/A	

Fabric SKU: N/A

Leather SKU: L-1010-35

Standard Pillows: N/A Finish Req: N

Standard Cushions: High Resiliency 35 Standard Finish: Nickel

COM: N/A yards COL: 79 square feet

Standard with a gas lift and a locking tilt mechanism. Only available in Leather.

Chrysler Office Swivel Chair

Width: 27.5 Depth: 28 Height: 43

AH: 0 SH: 0 SD: 19 IW: 20.25

Weight: 74 lbs Cube: 21.65

D	E	F	G	H	J	K COM	L	M	N	O	P	Q	R	S	T	U	(# above U) *	S Nail	M Nail
N/A	N/A	N/A	N/A	N/A	N/A	N/A	N/A	N/A	N/A	N/A	N/A	N/A	N/A	N/A	N/A	N/A	N/A (Riser) + N/A (U)	N/A	N/A
Leather 1 3615		Leather 2 3735		Leather 3 3855		Leather 4 3975		Leather 5 4095		Leather 6 4215		Leather 8 5235		COL 3615		S Nail N/A		M Nail N/A	

Fabric SKU: 1014-35

Leather SKU: N/A

Standard Pillows: N/A Finish Req: Y

Standard Cushions: High Resiliency 40 Standard Finish:

COM: 2.75 yards COL: N/A

Standard with a gas lift.

Troy Office Swivel Chair

Width: 27.5 Depth: 29.5 Height: 37.5

AH: 0 SH: 0 SD: 19.5 IW: 21

Weight: 60 lbs Cube: 21.65

D	E	F	G	H	J	K COM	L	M	N	O	P	Q	R	S	T	U	(# above U) *	S Nail	M Nail
1695	1704	1713	1722	1731	1740	1749	1758	1767	1776	1785	1794	1803	1812	1821	1830	1839	9 (Riser) + 1839 (U)	45	60
Leather 1 N/A		Leather 2 N/A		Leather 3 N/A		Leather 4 N/A		Leather 5 N/A		Leather 6 N/A		Leather 8 N/A		COL N/A		S Nail N/A		M Nail N/A	

Upholstery

**Pillows are not available on leather SKUs*

Fabric SKU: 1015-05

Leather SKU: L-1015-05

Standard Pillows: N/A Finish Req: Y

Standard Cushions: High Resiliency 40 Standard Finish:

COM: 2.75 yards COL: 48.6 square feet

Clark Side Chair

Width: 19.5 Depth: 26 Height: 40

AH: 0 SH: 20 SD: 18 IW: 20

Weight: 25 lbs Cube: 15.74

D	E	F	G	H	J	K COM	L	M	N	O	P	Q	R	S	T	U	(# above U) *	S Nail	M Nail
1125	1134	1143	1152	1161	1170	1179	1188	1197	1206	1215	1224	1233	1242	1251	1260	1269	9 (Riser) + 1269 (U)	45	60
Leather 1 1815		Leather 2 1890		Leather 3 1965		Leather 4 2040		Leather 5 2115		Leather 6 2190		Leather 8 2865		COL 1197		S Nail 45		M Nail 60	

Fabric SKU: 1015-07

Leather SKU: L-1015-07

Standard Pillows: N/A Finish Req: Y

Standard Cushions: High Resiliency 40 Standard Finish:

COM: 2.75 yards COL: 48.6 square feet

Clark Bar Stool

Width: 19.5 Depth: 23 Height: 45.5

AH: 0 SH: 30 SD: 16 IW: 19.5

Weight: 23 lbs Cube: 19.6

D	E	F	G	H	J	K COM	L	M	N	O	P	Q	R	S	T	U	(# above U) *	S Nail	M Nail
1230	1239	1248	1257	1266	1275	1284	1293	1302	1311	1320	1329	1338	1347	1356	1365	1374	9 (Riser) + 1374 (U)	45	60
Leather 1 1845		Leather 2 1920		Leather 3 1995		Leather 4 2070		Leather 5 2145		Leather 6 2220		Leather 8 2895		COL 1302		S Nail 45		M Nail 60	

Fabric SKU: 1015-C7

Leather SKU: L-1015-C7

Standard Pillows: N/A Finish Req: Y

Standard Cushions: High Resiliency 40 Standard Finish:

COM: 2.75 yards COL: 48.6 square feet

Clark Counter Stool

Width: 19.5 Depth: 23 Height: 41.5

AH: 0 SH: 26 SD: 16 IW: 19.5

Weight: 20 lbs Cube: 15.74

D	E	F	G	H	J	K COM	L	M	N	O	P	Q	R	S	T	U	(# above U) *	S Nail	M Nail
1230	1239	1248	1257	1266	1275	1284	1293	1302	1311	1320	1329	1338	1347	1356	1365	1374	9 (Riser) + 1374 (U)	45	60
Leather 1 1845		Leather 2 1920		Leather 3 1995		Leather 4 2070		Leather 5 2145		Leather 6 2220		Leather 8 2895		COL 1302		S Nail 45		M Nail 60	

Fabric SKU: 1019-01

Leather SKU: L-1019-01

Standard Pillows: N/A Finish Req: Y

Standard Cushions: High Resiliency 40 Standard Finish:

COM: 2.25 yards COL: 38.7 square feet

Thayer Occasional Chair

Width: 24.5 Depth: 23 Height: 30

AH: 24.5 SH: 18.5 SD: 18 IW: 19.5

Weight: 25 lbs Cube: 15.74

D	E	F	G	H	J	K COM	L	M	N	O	P	Q	R	S	T	U	(# above U) *	S Nail	M Nail
1200	1206	1212	1218	1224	1230	1236	1242	1248	1254	1260	1266	1272	1278	1284	1290	1296	6 (Riser) + 1296 (U)	Std.	N/A
Leather 1 1725		Leather 2 1785		Leather 3 1845		Leather 4 1905		Leather 5 1965		Leather 6 2025		Leather 8 2565		COL 1248		S Nail Std.		M Nail N/A	

Fabric SKU: 1019-A4

Leather SKU: L-1019-A4

Standard Pillows: N/A Finish Req: Y

Standard Cushions: High Resiliency 40 Standard Finish:

COM: 2.25 yards COL: 38.7 square feet

Thayer Occasional Chair

Width: 24.5 Depth: 23 Height: 30

AH: 24.5 SH: 18.5 SD: 18 IW: 19.5

Weight: 25 lbs Cube: 15.74

D	E	F	G	H	J	K COM	L	M	N	O	P	Q	R	S	T	U	(# above U) *	S Nail	M Nail
1272	1278	1284	1290	1296	1302	1308	1314	1320	1326	1332	1338	1344	1350	1356	1362	1368	6 (Riser) + 1368 (U)	Std.	N/A
Leather 1 1815		Leather 2 1875		Leather 3 1935		Leather 4 1995		Leather 5 2055		Leather 6 2115		Leather 8 2655		COL 1320		S Nail Std.		M Nail N/A	

Fabric SKU: 1021-04

Leather SKU: L-1021-04

Standard Pillows: N/A Finish Req: Y

Standard Cushions: High Resiliency 40 Standard Finish:

COM: 3.25 yards COL: 53.1 square feet

Bedford Arm Chair

Width: 24 Depth: 25.5 Height: 40

AH: 25.5 SH: 20 SD: 18 IW: 20.5

Weight: 25 lbs Cube: 21.65

D	E	F	G	H	J	K COM	L	M	N	O	P	Q	R	S	T	U	(# above U) *	S Nail	M Nail
1305	1314	1323	1332	1341	1350	1359	1368	1377	1386	1395	1404	1413	1422	1431	1440	1449	9 (Riser) + 1449 (U)	45	60
Leather 1 1980		Leather 2 2070		Leather 3 2160		Leather 4 2250		Leather 5 2340		Leather 6 2430		Leather 8 3165		COL 1377		S Nail 45		M Nail 60	

Upholstery

**Pillows are not available on leather SKUs*

Fabric SKU: 1021-05

Leather SKU: L-1021-05

Standard Pillows: N/A Finish Req: Y

Standard Cushions: High Resiliency 40 Standard Finish:

COM: 3.25 yards COL: 53.1 square feet

Bedford Side Chair

Width: 22.5 Depth: 25.5 Height: 40

AH: 0 SH: 20 SD: 18 IW: 22.5

Weight: 30 lbs Cube: 15.74

D	E	F	G	H	J	K COM	L	M	N	O	P	Q	R	S	T	U	(# above U) *	S Nail	M Nail
1275	1284	1293	1302	1311	1320	1329	1338	1347	1356	1365	1374	1383	1392	1401	1410	1419	9 (Riser) + 1419 (U)	60	75
Leather 1 1947		Leather 2 2037		Leather 3 2127		Leather 4 2217		Leather 5 2307		Leather 6 2397		Leather 8 3132		COL 1347		S Nail 60		M Nail 75	

Fabric SKU: 1029-35

Leather SKU: L-1029-35

Standard Pillows: N/A Finish Req: Y

Standard Cushions: High Resiliency 40 Standard Finish:

COM: 4 yards COL: 51 square feet

Standard with a gas lift.

Eaton Office Swivel Chair

Width: 25 Depth: 30.5 Height: 40.5

AH: 0 SH: 0 SD: 20 IW: 20

Weight: 65 lbs Cube: 26.89

D	E	F	G	H	J	K COM	L	M	N	O	P	Q	R	S	T	U	(# above U) *	S Nail	M Nail
1845	1857	1869	1881	1893	1905	1917	1929	1941	1953	1965	1977	1989	2001	2013	2025	2037	12 (Riser) + 2037 (U)	N/A	N/A
Leather 1 2520		Leather 2 2595		Leather 3 2670		Leather 4 2745		Leather 5 2820		Leather 6 2895		Leather 8 3600		COL 1941		S Nail N/A		M Nail N/A	

Fabric SKU: N/A

Leather SKU: L-1032-35

Standard Pillows: N/A Finish Req: N

Standard Cushions: High Resiliency 30 Standard Finish: Nickel

COM: N/A yards COL: 62 square feet

Standard with a gas lift and a locking tilt mechanism. Only available in Leather.

Gherkin Office Swivel Chair

Width: 27 Depth: 28 Height: 39.5

AH: 0 SH: 0 SD: 19.5 IW: 20

Weight: 50 lbs Cube: 21.65

D	E	F	G	H	J	K COM	L	M	N	O	P	Q	R	S	T	U	(# above U) *	S Nail	M Nail	
N/A	N/A	N/A	N/A	N/A	N/A	N/A	N/A	N/A	N/A	N/A	N/A	N/A	N/A	N/A	N/A	N/A	N/A	N/A (Riser) + N/A (U)	N/A	N/A
Leather 1 3225		Leather 2 3330		Leather 3 3435		Leather 4 3540		Leather 5 3645		Leather 6 3750		Leather 8 4605		COL 3225		S Nail N/A		M Nail N/A		

Fabric SKU: 1036-01

Leather SKU: N/A

Standard Pillows: N/A Finish Req: Y

Standard Cushions: High Resiliency 40 Standard Finish:

COM: 2.75 yards COL: N/A

Cabot Occasional Chair

Width: 25 Depth: 28.5 Height: 40.5

AH: 26 SH: 19.5 SD: 20 IW: 20.5

Weight: 30 lbs Cube: 21.65

D	E	F	G	H	J	K COM	L	M	N	O	P	Q	R	S	T	U	(# above U) *	S Nail	M Nail
1350	1359	1368	1377	1386	1395	1404	1413	1422	1431	1440	1449	1458	1467	1476	1485	1494	9 (Riser) + 1494 (U)	45	60
Leather 1 N/A		Leather 2 N/A		Leather 3 N/A		Leather 4 N/A		Leather 5 N/A		Leather 6 N/A		Leather 8 N/A		COL N/A		S Nail N/A		M Nail N/A	

Fabric SKU: 1046-35

Leather SKU: L-1046-35

Standard Pillows: N/A Finish Req: N

Standard Cushions: Ultra Plush Standard Finish: Nickel

COM: 3.75 yards COL: 62 square feet

Standard with a gas lift and a locking tilt mechanism.

Plaza 66 Office Swivel Chair

Width: 28.25 Depth: 31.75 Height: 43

AH: 0 SH: 0 SD: 20.75 IW: 19.5

Weight: 71 lbs Cube: 22.31

D	E	F	G	H	J	K COM	L	M	N	O	P	Q	R	S	T	U	(# above U) *	S Nail	M Nail
2295	2307	2319	2331	2343	2355	2367	2379	2391	2403	2415	2427	2439	2451	2463	2475	2487	12 (Riser) + 2487 (U)	Std.	N/A
Leather 1 3135		Leather 2 3240		Leather 3 3345		Leather 4 3450		Leather 5 3555		Leather 6 3660		Leather 8 4515		COL 2391		S Nail Std.		M Nail N/A	

Fabric SKU: 1049-35

Leather SKU: L-1049-35

Standard Pillows: N/A Finish Req: Y

Standard Cushions: High Resiliency 40 Standard Finish:

COM: 3.25 yards COL: 51 square feet

Standard with a gas lift.

Taft Office Swivel Chair

Width: 24.5 Depth: 30.5 Height: 36

AH: 25.5 SH: 17 SD: 22 IW: 20

Weight: 50 lbs Cube: 21.65

D	E	F	G	H	J	K COM	L	M	N	O	P	Q	R	S	T	U	(# above U) *	S Nail	M Nail
1860	1869	1878	1887	1896	1905	1914	1923	1932	1941	1950	1959	1968	1977	1986	1995	2004	9 (Riser) + 2004 (U)	Std.	N/A
Leather 1 2640		Leather 2 2715		Leather 3 2790		Leather 4 2865		Leather 5 2940		Leather 6 3015		Leather 8 3720		COL 1932		S Nail Std.		M Nail N/A	

Upholstery

**Pillows are not available on leather SKUs*

Fabric SKU: **1059-35**

Leather SKU: **L-1059-35**

Standard Pillows: N/A **Finish Req:** Y
Standard Cushions: High Resiliency 40 **Standard Finish:**
COM: 3.5 yards **COL:** 62 square feet
 Standard with a gas lift.

Stanford Office Swivel Chair

Width: 25 **Depth:** 31 **Height:** 36.5
AH: 0 **SH:** 0 **SD:** 21 **IW:** 19
Weight: 55 lbs **Cube:** 23.22

D	E	F	G	H	J	K COM	L	M	N	O	P	Q	R	S	T	U	(# above U) *	S Nail	M Nail
1965	1974	1983	1992	2001	2010	2019	2028	2037	2046	2055	2064	2073	2082	2091	2100	2109	9 (Riser) + 2109 (U)	Std.	N/A
Leather 1 2895		Leather 2 3000		Leather 3 3105		Leather 4 3210		Leather 5 3315		Leather 6 3420		Leather 8 4275		COL 2037		S Nail Std.		M Nail N/A	

Fabric SKU: **1073-05**

Leather SKU: **N/A**

Standard Pillows: N/A **Finish Req:** N
Standard Cushions: High Resiliency 40 **Standard Finish:** Traditional
COM: 4 yards **COL:** N/A

Logan Side Chair

Width: 19.5 **Depth:** 26 **Height:** 40
AH: 0 **SH:** 20 **SD:** 18 **IW:** 20
Weight: 25 lbs **Cube:** 15.74

D	E	F	G	H	J	K COM	L	M	N	O	P	Q	R	S	T	U	(# above U) *	S Nail	M Nail
1395	1407	1419	1431	1443	1455	1467	1479	1491	1503	1515	1527	1539	1551	1563	1575	1587	12 (Riser) + 1587 (U)	N/A	N/A
Leather 1 N/A		Leather 2 N/A		Leather 3 N/A		Leather 4 N/A		Leather 5 N/A		Leather 6 N/A		Leather 8 N/A		COL N/A		S Nail N/A		M Nail N/A	

Fabric SKU: **1082-01**

Leather SKU: **L-1082-01**

Standard Pillows: N/A **Finish Req:** Y
Standard Cushions: High Resiliency 40 **Standard Finish:**
COM: 2.75 yards **COL:** 48.6 square feet

Addison Occasional Chair

Width: 24.5 **Depth:** 28.5 **Height:** 40.5
AH: 26.5 **SH:** 19.5 **SD:** 19.5 **IW:** 20
Weight: 30 lbs **Cube:** 21.65

D	E	F	G	H	J	K COM	L	M	N	O	P	Q	R	S	T	U	(# above U) *	S Nail	M Nail
1320	1329	1338	1347	1356	1365	1374	1383	1392	1401	1410	1419	1428	1437	1446	1455	1464	9 (Riser) + 1464 (U)	45	60
Leather 1 1980		Leather 2 2055		Leather 3 2130		Leather 4 2205		Leather 5 2280		Leather 6 2355		Leather 8 3030		COL 1392		S Nail 45		M Nail 60	

Fabric SKU: **1082-A4**

Leather SKU: **L-1082-A4**

Standard Pillows: N/A **Finish Req:** Y
Standard Cushions: High Resiliency 40 **Standard Finish:**
COM: 2.75 yards **COL:** 48.6 square feet

Addison Occasional Chair

Width: 24.5 **Depth:** 28.5 **Height:** 40.5
AH: 26.5 **SH:** 19.5 **SD:** 19.5 **IW:** 20
Weight: 30 lbs **Cube:** 21.65

D	E	F	G	H	J	K COM	L	M	N	O	P	Q	R	S	T	U	(# above U) *	S Nail	M Nail
1392	1401	1410	1419	1428	1437	1446	1455	1464	1473	1482	1491	1500	1509	1518	1527	1536	9 (Riser) + 1536 (U)	45	60
Leather 1 2064		Leather 2 2139		Leather 3 2214		Leather 4 2289		Leather 5 2364		Leather 6 2439		Leather 8 3114		COL 1464		S Nail 45		M Nail 60	

Fabric SKU: **1083-35**

Leather SKU: **L-1083-35**

Standard Pillows: N/A **Finish Req:** Y
Standard Cushions: High Resiliency 30 **Standard Finish:**
COM: 6.25 yards **COL:** 107 square feet
 Standard with a gas lift.

Wendell Office Swivel Chair

Width: 30 **Depth:** 35.5 **Height:** 46.5
AH: 0 **SH:** 0 **SD:** 18 **IW:** 19.5
Weight: 85 lbs **Cube:** 34.38

D	E	F	G	H	J	K COM	L	M	N	O	P	Q	R	S	T	U	(# above U) *	S Nail	M Nail
2895	2913	2931	2949	2967	2985	3003	3021	3039	3057	3075	3093	3111	3129	3147	3165	3183	18 (Riser) + 3183 (U)	Std.	N/A
Leather 1 4275		Leather 2 4440		Leather 3 4605		Leather 4 4770		Leather 5 4935		Leather 6 5100		Leather 8 6570		COL 3039		S Nail Std.		M Nail N/A	

Fabric SKU: **1087-35**

Leather SKU: **L-1087-35**

Standard Pillows: N/A **Finish Req:** N
Standard Cushions: High Resiliency 40 **Standard Finish:** Nickel
COM: 3.5 yards **COL:** 62 square feet
 Standard with a gas lift and a locking tilt mechanism.

Empire Office Swivel Chair

Width: 26.5 **Depth:** 27 **Height:** 42.5
AH: 0 **SH:** 0 **SD:** 20 **IW:** 19
Weight: 73 lbs **Cube:** 21.65

D	E	F	G	H	J	K COM	L	M	N	O	P	Q	R	S	T	U	(# above U) *	S Nail	M Nail
1935	1947	1959	1971	1983	1995	2007	2019	2031	2043	2055	2067	2079	2091	2103	2115	2127	12 (Riser) + 2127 (U)	N/A	N/A
Leather 1 2730		Leather 2 2835		Leather 3 2940		Leather 4 3045		Leather 5 3150		Leather 6 3255		Leather 8 4110		COL 2031		S Nail N/A		M Nail N/A	

Upholstery

**Pillows are not available on leather SKUs*

Fabric SKU: **1088-35**

Leather SKU: **L-1088-35**

Standard Pillows: N/A **Finish Req:** Y

Standard Cushions: High Resiliency 40 **Standard Finish:**

COM: 4.5 yards **COL:** 79 square feet

Standard with a gas lift.

Somerset Office Swivel Chair

Width: 28 **Depth:** 31 **Height:** 44

AH: 27 **SH:** 20.5 **SD:** 20.5 **IW:** 19

Weight: 35 lbs **Cube:** 23.22

D	E	F	G	H	J	K COM	L	M	N	O	P	Q	R	S	T	U	(# above U) *	S Nail	M Nail
2235	2250	2265	2280	2295	2310	2325	2340	2355	2370	2385	2400	2415	2430	2445	2460	2475	15 (Riser) + 2475 (U)	Std.	N/A
Leather 1 3300		Leather 2 3420		Leather 3 3540		Leather 4 3660		Leather 5 3780		Leather 6 3900		Leather 8 4995		COL 2355		S Nail Std.		M Nail N/A	

Fabric SKU: **1100-01**

Leather SKU: **N/A**

Standard Pillows: N/A **Finish Req:** N

Standard Cushions: Classic Plush **Standard Finish:**

COM: 10.25 yards **COL:** N/A

Our Charlton lounge chair is a larger scaled chair with a higher back. Also available in a swivel and swivel glider.

Charlton Lounge Chair

Width: 33.5 **Depth:** 39 **Height:** 41

AH: 23.5 **SH:** 19 **SD:** 23 **IW:** 27

Weight: 80 lbs **Cube:** 41.32

D	E	F	G	H	J	K COM	L	M	N	O	P	Q	R	S	T	U	(# above U) *	S Nail	M Nail
2250	2280	2310	2340	2370	2400	2430	2460	2490	2520	2550	2580	2610	2640	2670	2700	2730	30 (Riser) + 2730 (U)	90	105
Leather 1 N/A		Leather 2 N/A		Leather 3 N/A		Leather 4 N/A		Leather 5 N/A		Leather 6 N/A		Leather 8 N/A		COL N/A		S Nail N/A		M Nail N/A	

Fabric SKU: **1100-31**

Leather SKU: **N/A**

Standard Pillows: N/A **Finish Req:** N

Standard Cushions: Classic Plush **Standard Finish:**

COM: 10.25 yards **COL:** N/A

Charlton Swivel Chair

Width: 33.5 **Depth:** 39 **Height:** 41

AH: 23.5 **SH:** 19 **SD:** 23 **IW:** 27

Weight: 80 lbs **Cube:** 30.99

D	E	F	G	H	J	K COM	L	M	N	O	P	Q	R	S	T	U	(# above U) *	S Nail	M Nail
2325	2355	2385	2415	2445	2475	2505	2535	2565	2595	2625	2655	2685	2715	2745	2775	2805	30 (Riser) + 2805 (U)	90	105
Leather 1 N/A		Leather 2 N/A		Leather 3 N/A		Leather 4 N/A		Leather 5 N/A		Leather 6 N/A		Leather 8 N/A		COL N/A		S Nail N/A		M Nail N/A	

Fabric SKU: **1100-32**

Leather SKU: **N/A**

Standard Pillows: N/A **Finish Req:** N

Standard Cushions: Classic Plush **Standard Finish:**

COM: 10.25 yards **COL:** N/A

Charlton Swivel Glider

Width: 33.5 **Depth:** 39 **Height:** 41

AH: 23.5 **SH:** 19 **SD:** 23 **IW:** 27

Weight: 80 lbs **Cube:** 30.99

D	E	F	G	H	J	K COM	L	M	N	O	P	Q	R	S	T	U	(# above U) *	S Nail	M Nail
2475	2505	2535	2565	2595	2625	2655	2685	2715	2745	2775	2805	2835	2865	2895	2925	2955	30 (Riser) + 2955 (U)	90	105
Leather 1 N/A		Leather 2 N/A		Leather 3 N/A		Leather 4 N/A		Leather 5 N/A		Leather 6 N/A		Leather 8 N/A		COL N/A		S Nail N/A		M Nail N/A	

Fabric SKU: **1102-31**

Leather SKU: **N/A**

Standard Pillows: N/A **Finish Req:** N

Standard Cushions: Classic Plush **Standard Finish:**

COM: 6.5 yards **COL:** N/A

Small Nail Trim Standard

Christine Swivel Chair

Width: 30 **Depth:** 33 **Height:** 35

AH: 27.5 **SH:** 17.5 **SD:** 20 **IW:** 22.5

Weight: 82 lbs **Cube:** 29.69

D	E	F	G	H	J	K COM	L	M	N	O	P	Q	R	S	T	U	(# above U) *	S Nail	M Nail
2085	2103	2121	2139	2157	2175	2193	2211	2229	2247	2265	2283	2301	2319	2337	2355	2373	18 (Riser) + 2373 (U)	Std.	N/A
Leather 1 N/A		Leather 2 N/A		Leather 3 N/A		Leather 4 N/A		Leather 5 N/A		Leather 6 N/A		Leather 8 N/A		COL N/A		S Nail N/A		M Nail N/A	

Fabric SKU: **1102-32**

Leather SKU: **N/A**

Standard Pillows: N/A **Finish Req:** N

Standard Cushions: Classic Plush **Standard Finish:**

COM: 6.5 yards **COL:** N/A

Small Nail Trim Standard

Christine Swivel Glider

Width: 30 **Depth:** 33 **Height:** 35

AH: 27.5 **SH:** 17.5 **SD:** 20 **IW:** 22.5

Weight: 82 lbs **Cube:** 20.05

D	E	F	G	H	J	K COM	L	M	N	O	P	Q	R	S	T	U	(# above U) *	S Nail	M Nail
2235	2253	2271	2289	2307	2325	2343	2361	2379	2397	2415	2433	2451	2469	2487	2505	2523	18 (Riser) + 2523 (U)	Std.	N/A
Leather 1 N/A		Leather 2 N/A		Leather 3 N/A		Leather 4 N/A		Leather 5 N/A		Leather 6 N/A		Leather 8 N/A		COL N/A		S Nail N/A		M Nail N/A	

Upholstery

**Pillows are not available on leather SKUs*

Fabric SKU: 1111-31

Leather SKU: L-1111-31

Standard Pillows: (1) Kidney Pillow **Finish Req:** Y

Standard Cushions: Ultra Plush **Standard Finish:**

COM: 7.5 yards **COL:** 122.4 square feet

Lyon Swivel Chair

Width: 32 **Depth:** 34 **Height:** 36

AH: 25.5 **SH:** 20.5 **SD:** 19 **IW:** 22

Weight: 95 lbs **Cube:** 29.29

D	E	F	G	H	J	K COM	L	M	N	O	P	Q	R	S	T	U	(# above U) *	S Nail	M Nail
2850	2871	2892	2913	2934	2955	2976	2997	3018	3039	3060	3081	3102	3123	3144	3165	3186	21 (Riser) + 3186 (U)	120	N/A
Leather 1 4455		Leather 2 4650		Leather 3 4845		Leather 4 5040		Leather 5 5235		Leather 6 5430		Leather 8 7125		COL 3018		S Nail 120		M Nail N/A	

Fabric SKU: 1121-31

Leather SKU: N/A

Standard Pillows: N/A **Finish Req:** N

Standard Cushions: Ultra Plush **Standard Finish:**

COM: 10 yards **COL:** N/A

Weston Swivel Chair

Width: 32 **Depth:** 37.5 **Height:** 36.5

AH: 25.5 **SH:** 21 **SD:** 20 **IW:** 23

Weight: 65 lbs **Cube:** 33.92

D	E	F	G	H	J	K COM	L	M	N	O	P	Q	R	S	T	U	(# above U) *	S Nail	M Nail
2325	2355	2385	2415	2445	2475	2505	2535	2565	2595	2625	2655	2685	2715	2745	2775	2805	30 (Riser) + 2805 (U)	45	60
Leather 1 N/A		Leather 2 N/A		Leather 3 N/A		Leather 4 N/A		Leather 5 N/A		Leather 6 N/A		Leather 8 N/A		COL N/A		S Nail N/A		M Nail N/A	

Fabric SKU: 1138-01

Leather SKU: L-1138-01

Standard Pillows: N/A **Finish Req:** Y

Standard Cushions: Ultra Plush **Standard Finish:**

COM: 4.75 yards **COL:** 85 square feet

Tipsy Lounge Chair

Wooden Base

Width: 28.75 **Depth:** 32 **Height:** 30.25

AH: 25 **SH:** 19 **SD:** 22.5 **IW:** 22

Weight: 72 lbs **Cube:** 23.89

D	E	F	G	H	J	K COM	L	M	N	O	P	Q	R	S	T	U	(# above U) *	S Nail	M Nail
2100	2115	2130	2145	2160	2175	2190	2205	2220	2235	2250	2265	2280	2295	2310	2325	2340	15 (Riser) + 2340 (U)	60	75
Leather 1 3201		Leather 2 3336		Leather 3 3471		Leather 4 3606		Leather 5 3741		Leather 6 3876		Leather 8 5046		COL 2220		S Nail 60		M Nail 75	

Fabric SKU: 1138-01-2

Leather SKU: L-1138-01-2

Standard Pillows: N/A **Finish Req:** N

Standard Cushions: Ultra Plush **Standard Finish:** Nickel

COM: 4.75 yards **COL:** 85 square feet

Only available in Nickel

Tipsy Lounge Chair

Nickel Base

Width: 28.75 **Depth:** 32 **Height:** 30.25

AH: 25 **SH:** 19 **SD:** 22.5 **IW:** 22

Weight: 72 lbs **Cube:** 23.89

D	E	F	G	H	J	K COM	L	M	N	O	P	Q	R	S	T	U	(# above U) *	S Nail	M Nail
2400	2415	2430	2445	2460	2475	2490	2505	2520	2535	2550	2565	2580	2595	2610	2625	2640	15 (Riser) + 2640 (U)	60	75
Leather 1 3465		Leather 2 3600		Leather 3 3735		Leather 4 3870		Leather 5 4005		Leather 6 4140		Leather 8 5310		COL 2520		S Nail 60		M Nail 75	

Fabric SKU: 1138-01-7

Leather SKU: L-1138-01-7

Standard Pillows: N/A **Finish Req:** N

Standard Cushions: Ultra Plush **Standard Finish:** Bright Brass

COM: 4.75 yards **COL:** 85 square feet

Only available in Bright Brass

Tipsy Lounge Chair

Bright Brass Base

Width: 28.75 **Depth:** 32 **Height:** 30.25

AH: 25 **SH:** 19 **SD:** 22.5 **IW:** 22

Weight: 72 lbs **Cube:** 23.89

D	E	F	G	H	J	K COM	L	M	N	O	P	Q	R	S	T	U	(# above U) *	S Nail	M Nail
2400	2415	2430	2445	2460	2475	2490	2505	2520	2535	2550	2565	2580	2595	2610	2625	2640	15 (Riser) + 2640 (U)	60	75
Leather 1 3465		Leather 2 3600		Leather 3 3735		Leather 4 3870		Leather 5 4005		Leather 6 4140		Leather 8 5310		COL 2520		S Nail 60		M Nail 75	

Fabric SKU: 1138-31

Leather SKU: L-1138-31

Standard Pillows: N/A **Finish Req:** Y

Standard Cushions: Ultra Plush **Standard Finish:**

COM: 4.75 yards **COL:** 85 square feet

Tipsy Swivel Chair

Width: 28.75 **Depth:** 31 **Height:** 30.25

AH: 25 **SH:** 19 **SD:** 22.5 **IW:** 22

Weight: 59 lbs **Cube:** 23.89

D	E	F	G	H	J	K COM	L	M	N	O	P	Q	R	S	T	U	(# above U) *	S Nail	M Nail
2175	2190	2205	2220	2235	2250	2265	2280	2295	2310	2325	2340	2355	2370	2385	2400	2415	15 (Riser) + 2415 (U)	60	75
Leather 1 3285		Leather 2 3420		Leather 3 3555		Leather 4 3690		Leather 5 3825		Leather 6 3960		Leather 8 5130		COL 2295		S Nail 60		M Nail 75	

Upholstery

**Pillows are not available on leather SKUs*

Fabric SKU: 1138-31-2

Leather SKU: L-1138-31-2

Standard Pillows: N/A Finish Req: N

Standard Cushions: Ultra Plush Standard Finish: Nickel

COM: 4.75 yards COL: 85 square feet

Only available in Nickel finish

Tipsy Swivel Chair

Width: 28.75 Depth: 31 Height: 30.25

AH: 25 SH: 19 SD: 22.5 IW: 22

Weight: 59 lbs Cube: 15.6

D	E	F	G	H	J	K COM	L	M	N	O	P	Q	R	S	T	U	(# above U) *	S Nail	M Nail
2475	2490	2505	2520	2535	2550	2565	2580	2595	2610	2625	2640	2655	2670	2685	2700	2715	15 (Riser) + 2715 (U)	60	75
Leather 1 3549		Leather 2 3684		Leather 3 3819		Leather 4 3954		Leather 5 4089		Leather 6 4224		Leather 8 5394		COL 2595		S Nail 60		M Nail 75	

Fabric SKU: 1138-31-7

Leather SKU: L-1138-31-7

Standard Pillows: N/A Finish Req: N

Standard Cushions: Ultra Plush Standard Finish: Bright Brass

COM: 4.75 yards COL: 85 square feet

Only available in Bright Brass finish

Tipsy Swivel Chair

Width: 28.75 Depth: 31 Height: 30.25

AH: 25 SH: 19 SD: 22.5 IW: 22

Weight: 59 lbs Cube: 23.89

D	E	F	G	H	J	K COM	L	M	N	O	P	Q	R	S	T	U	(# above U) *	S Nail	M Nail
2475	2490	2505	2520	2535	2550	2565	2580	2595	2610	2625	2640	2655	2670	2685	2700	2715	15 (Riser) + 2715 (U)	60	75
Leather 1 3549		Leather 2 3684		Leather 3 3819		Leather 4 3954		Leather 5 4089		Leather 6 4224		Leather 8 5394		COL 2595		S Nail 60		M Nail 75	

Fabric SKU: 1139-01

Leather SKU: L-1139-01

Standard Pillows: N/A Finish Req: Y

Standard Cushions: Ultra Plush Standard Finish:

COM: 4.75 yards COL: 102 square feet

Tipsy Lounge Chair

Wooden Base

Width: 28.75 Depth: 31 Height: 30.25

AH: 25.5 SH: 19 SD: 22 IW: 21.25

Weight: 59 lbs Cube: 23.89

D	E	F	G	H	J	K COM	L	M	N	O	P	Q	R	S	T	U	(# above U) *	S Nail	M Nail
2325	2340	2355	2370	2385	2400	2415	2430	2445	2460	2475	2490	2505	2520	2535	2550	2565	15 (Riser) + 2565 (U)	60	75
Leather 1 3531		Leather 2 3696		Leather 3 3861		Leather 4 4026		Leather 5 4191		Leather 6 4356		Leather 8 5766		COL 2445		S Nail 60		M Nail 75	

Fabric SKU: 1139-01-2

Leather SKU: L-1139-01-2

Standard Pillows: N/A Finish Req: N

Standard Cushions: Ultra Plush Standard Finish: Nickel

COM: 4.75 yards COL: 85 square feet

Only available in Nickel

Tipsy Lounge Chair

Nickel Base

Width: 28.75 Depth: 31 Height: 30.25

AH: 25.5 SH: 19 SD: 22 IW: 21.25

Weight: 59 lbs Cube: 23.89

D	E	F	G	H	J	K COM	L	M	N	O	P	Q	R	S	T	U	(# above U) *	S Nail	M Nail
2625	2640	2655	2670	2685	2700	2715	2730	2745	2760	2775	2790	2805	2820	2835	2850	2865	15 (Riser) + 2865 (U)	60	75
Leather 1 3714		Leather 2 3849		Leather 3 3984		Leather 4 4119		Leather 5 4254		Leather 6 4389		Leather 8 5559		COL 2745		S Nail 60		M Nail 75	

Fabric SKU: 1139-01-7

Leather SKU: L-1139-01-7

Standard Pillows: N/A Finish Req: N

Standard Cushions: Ultra Plush Standard Finish: Bright Brass

COM: 4.75 yards COL: 85 square feet

Only available in Bright Brass

Tipsy Lounge Chair

Bright Brass Base

Width: 28.75 Depth: 31 Height: 30.25

AH: 25.5 SH: 19 SD: 22 IW: 21.25

Weight: 59 lbs Cube: 23.89

D	E	F	G	H	J	K COM	L	M	N	O	P	Q	R	S	T	U	(# above U) *	S Nail	M Nail
2625	2640	2655	2670	2685	2700	2715	2730	2745	2760	2775	2790	2805	2820	2835	2850	2865	15 (Riser) + 2865 (U)	60	75
Leather 1 3714		Leather 2 3849		Leather 3 3984		Leather 4 4119		Leather 5 4254		Leather 6 4389		Leather 8 5559		COL 2745		S Nail 60		M Nail 75	

Fabric SKU: 1139-31

Leather SKU: L-1139-31

Standard Pillows: N/A Finish Req: Y

Standard Cushions: Ultra Plush Standard Finish:

COM: 4.75 yards COL: 85 square feet

Tipsy Swivel Chair

Width: 28.75 Depth: 31 Height: 30.25

AH: 25.5 SH: 19 SD: 22 IW: 21.25

Weight: 59 lbs Cube: 23.89

D	E	F	G	H	J	K COM	L	M	N	O	P	Q	R	S	T	U	(# above U) *	S Nail	M Nail
2430	2445	2460	2475	2490	2505	2520	2535	2550	2565	2580	2595	2610	2625	2640	2655	2670	15 (Riser) + 2670 (U)	60	75
Leather 1 3615		Leather 2 3750		Leather 3 3885		Leather 4 4020		Leather 5 4155		Leather 6 4290		Leather 8 5460		COL 2550		S Nail 60		M Nail 75	

Upholstery

**Pillows are not available on leather SKUs*

Fabric SKU: 1139-31-2

Leather SKU: L-1139-31-2

Standard Pillows: N/A Finish Req: N

Standard Cushions: Ultra Plush Standard Finish: Nickel

COM: 4.75 yards COL: 85 square feet

Only available in Nickel finish

Tipsy Swivel Chair

Width: 28.75 Depth: 31 Height: 30.25

AH: 25.5 SH: 19 SD: 22 IW: 21.25

Weight: 59 lbs Cube: 15.6

D	E	F	G	H	J	K COM	L	M	N	O	P	Q	R	S	T	U	(# above U) *	S Nail	M Nail
2700	2715	2730	2745	2760	2775	2790	2805	2820	2835	2850	2865	2880	2895	2910	2925	2940	15 (Riser) + 2940 (U)	60	75
Leather 1 3795		Leather 2 3930		Leather 3 4065		Leather 4 4200		Leather 5 4335		Leather 6 4470		Leather 8 5640		COL 2820		S Nail 60		M Nail 75	

Fabric SKU: 1139-31-7

Leather SKU: L-1139-31-7

Standard Pillows: N/A Finish Req: N

Standard Cushions: Ultra Plush Standard Finish: Bright Brass

COM: 4.75 yards COL: 85 square feet

Only available in Bright Brass finish

Tipsy Swivel Chair

Width: 28.75 Depth: 31 Height: 30.25

AH: 25.5 SH: 19 SD: 22 IW: 21.25

Weight: 59 lbs Cube: 23.89

D	E	F	G	H	J	K COM	L	M	N	O	P	Q	R	S	T	U	(# above U) *	S Nail	M Nail
2700	2715	2730	2745	2760	2775	2790	2805	2820	2835	2850	2865	2880	2895	2910	2925	2940	15 (Riser) + 2940 (U)	60	75
Leather 1 3795		Leather 2 3930		Leather 3 4065		Leather 4 4200		Leather 5 4335		Leather 6 4470		Leather 8 5640		COL 2820		S Nail 60		M Nail 75	

Fabric SKU: 1144-31

Leather SKU: L-1144-31

Standard Pillows: N/A Finish Req: N

Standard Cushions: Ultra Plush Standard Finish:

COM: 6.25 yards COL: 107 square feet

Kyle Swivel Chair

Width: 28.5 Depth: 35 Height: 31.5

AH: 25.5 SH: 20 SD: 23 IW: 22

Weight: 67 lbs Cube: 29.69

D	E	F	G	H	J	K COM	L	M	N	O	P	Q	R	S	T	U	(# above U) *	S Nail	M Nail
2145	2163	2181	2199	2217	2235	2253	2271	2289	2307	2325	2343	2361	2379	2397	2415	2433	18 (Riser) + 2433 (U)	75	90
Leather 1 3525		Leather 2 3690		Leather 3 3855		Leather 4 4020		Leather 5 4185		Leather 6 4350		Leather 8 5820		COL 2289		S Nail 75		M Nail 90	

Fabric SKU: 1180-31

Leather SKU: L-1180-31

Standard Pillows: N/A Finish Req: N

Standard Cushions: Ultra Plush Standard Finish:

COM: 6.5 yards COL: 113 square feet

Emery Swivel Chair

Width: 32 Depth: 37 Height: 32.5

AH: 25 SH: 19 SD: 23 IW: 22

Weight: 81 lbs Cube: 29.69

D	E	F	G	H	J	K COM	L	M	N	O	P	Q	R	S	T	U	(# above U) *	S Nail	M Nail
2280	2298	2316	2334	2352	2370	2388	2406	2424	2442	2460	2478	2496	2514	2532	2550	2568	18 (Riser) + 2568 (U)	90	105
Leather 1 3855		Leather 2 4035		Leather 3 4215		Leather 4 4395		Leather 5 4575		Leather 6 4755		Leather 8 6315		COL 2424		S Nail 90		M Nail 105	

Fabric SKU: 1181-01

Leather SKU: N/A

Standard Pillows: N/A Finish Req: Y

Standard Cushions: Ultra Plush Standard Finish:

COM: 7 yards COL: N/A

Mason Lounge Chair

Width: 30 Depth: 37 Height: 34.5

AH: 25.5 SH: 18.5 SD: 23 IW: 23

Weight: 73 lbs Cube: 29.69

D	E	F	G	H	J	K COM	L	M	N	O	P	Q	R	S	T	U	(# above U) *	S Nail	M Nail
2385	2406	2427	2448	2469	2490	2511	2532	2553	2574	2595	2616	2637	2658	2679	2700	2721	21 (Riser) + 2721 (U)	75	90
Leather 1 N/A		Leather 2 N/A		Leather 3 N/A		Leather 4 N/A		Leather 5 N/A		Leather 6 N/A		Leather 8 N/A		COL N/A		S Nail N/A		M Nail N/A	

Fabric SKU: 1181-31

Leather SKU: N/A

Standard Pillows: N/A Finish Req: N

Standard Cushions: Ultra Plush Standard Finish:

COM: 7 yards COL: N/A

Mason Swivel Chair

Width: 30 Depth: 37 Height: 34.5

AH: 25.5 SH: 18.5 SD: 23 IW: 23

Weight: 73 lbs Cube: 29.69

D	E	F	G	H	J	K COM	L	M	N	O	P	Q	R	S	T	U	(# above U) *	S Nail	M Nail
2385	2406	2427	2448	2469	2490	2511	2532	2553	2574	2595	2616	2637	2658	2679	2700	2721	21 (Riser) + 2721 (U)	75	90
Leather 1 N/A		Leather 2 N/A		Leather 3 N/A		Leather 4 N/A		Leather 5 N/A		Leather 6 N/A		Leather 8 N/A		COL N/A		S Nail N/A		M Nail N/A	

Upholstery

**Pillows are not available on leather SKUs*

Fabric SKU: 1401-01

Leather SKU: L-1401-01

Standard Pillows: N/A Finish Req: N

Standard Cushions: High Resiliency 35 Standard Finish:

COM: 4 yards COL: 79 square feet

Socrates Stationary Barrell Back Dining Chair

Width: 24 Depth: 24 Height: 31.5

AH: 0 SH: 19.5 SD: 20 IW: 20

Weight: 29 lbs Cube: 10.5

D	E	F	G	H	J	K COM	L	M	N	O	P	Q	R	S	T	U	(# above U) *	S Nail	M Nail
1200	1212	1224	1236	1248	1260	1272	1284	1296	1308	1320	1332	1344	1356	1368	1380	1392	12 (Riser) + 1392 (U)	60	N/A
Leather 1 2355		Leather 2 2475		Leather 3 2595		Leather 4 2715		Leather 5 2835		Leather 6 2955		Leather 8 4050		COL 1296		S Nail 60		M Nail N/A	

Fabric SKU: 1401-05

Leather SKU: L-1401-05

Standard Pillows: N/A Finish Req: N

Standard Cushions: High Resiliency 35 Standard Finish:

COM: 4 yards COL: 79 square feet

Features six concealed casters.

Socrates Barrell Back Dining Chair

with Casters

Width: 24 Depth: 24 Height: 31.5

AH: 0 SH: 19.5 SD: 20 IW: 20

Weight: 29 lbs Cube: 10.5

D	E	F	G	H	J	K COM	L	M	N	O	P	Q	R	S	T	U	(# above U) *	S Nail	M Nail
1200	1212	1224	1236	1248	1260	1272	1284	1296	1308	1320	1332	1344	1356	1368	1380	1392	12 (Riser) + 1392 (U)	60	N/A
Leather 1 2355		Leather 2 2475		Leather 3 2595		Leather 4 2715		Leather 5 2835		Leather 6 2955		Leather 8 4050		COL 1296		S Nail 60		M Nail N/A	

Fabric SKU: 1402-01

Leather SKU: L-1402-01

Standard Pillows: N/A Finish Req: N

Standard Cushions: High Resiliency 35 Standard Finish:

COM: 4 yards COL: 74 square feet

Aristotle Stationary Barrell Back Dining Chair

Width: 24 Depth: 24 Height: 31.5

AH: 0 SH: 19.5 SD: 20 IW: 20

Weight: 29 lbs Cube: 10.5

D	E	F	G	H	J	K COM	L	M	N	O	P	Q	R	S	T	U	(# above U) *	S Nail	M Nail
1200	1212	1224	1236	1248	1260	1272	1284	1296	1308	1320	1332	1344	1356	1368	1380	1392	12 (Riser) + 1392 (U)	60	N/A
Leather 1 2355		Leather 2 2475		Leather 3 2595		Leather 4 2715		Leather 5 2835		Leather 6 2955		Leather 8 3975		COL 1296		S Nail 60		M Nail N/A	

Fabric SKU: 1402-05

Leather SKU: L-1402-05

Standard Pillows: N/A Finish Req: N

Standard Cushions: High Resiliency 35 Standard Finish:

COM: 4 yards COL: 74 square feet

Features six concealed casters.

Aristotle Barrell Back Dining Chair

with Casters

Width: 24 Depth: 24 Height: 31.5

AH: 0 SH: 19.5 SD: 20 IW: 20

Weight: 29 lbs Cube: 10.5

D	E	F	G	H	J	K COM	L	M	N	O	P	Q	R	S	T	U	(# above U) *	S Nail	M Nail
1200	1212	1224	1236	1248	1260	1272	1284	1296	1308	1320	1332	1344	1356	1368	1380	1392	12 (Riser) + 1392 (U)	60	N/A
Leather 1 2355		Leather 2 2475		Leather 3 2595		Leather 4 2715		Leather 5 2835		Leather 6 2955		Leather 8 3975		COL 1296		S Nail 60		M Nail N/A	

Fabric SKU: 1404-01

Leather SKU: N/A

Standard Pillows: N/A Finish Req: Y

Standard Cushions: Classic Plush Standard Finish:

COM: 7.75 yards COL: N/A

Like Butter Barrell Lounge Chair

Width: 36 Depth: 37 Height: 34

AH: 25 SH: 20 SD: 20 IW: 21.5

Weight: 96 lbs Cube: 26.2

D	E	F	G	H	J	K COM	L	M	N	O	P	Q	R	S	T	U	(# above U) *	S Nail	M Nail
2550	2574	2598	2622	2646	2670	2694	2718	2742	2766	2790	2814	2838	2862	2886	2910	2934	24 (Riser) + 2934 (U)	N/A	N/A
Leather 1 N/A		Leather 2 N/A		Leather 3 N/A		Leather 4 N/A		Leather 5 N/A		Leather 6 N/A		Leather 8 N/A		COL N/A		S Nail N/A		M Nail N/A	

Fabric SKU: 1406-01

Leather SKU: L-1406-01

Standard Pillows: N/A Finish Req: Y

Standard Cushions: High Resiliency 40 Standard Finish:

COM: 5.25 yards COL: 85 square feet

Features a Clean Out Seat

Clara Lounge Chair

Clean Out Seat

Width: 27.5 Depth: 27 Height: 35.5

AH: 24.5 SH: 19.5 SD: 20 IW: 21

Weight: 46 lbs Cube: 15.25

D	E	F	G	H	J	K COM	L	M	N	O	P	Q	R	S	T	U	(# above U) *	S Nail	M Nail
1875	1893	1911	1929	1947	1965	1983	2001	2019	2037	2055	2073	2091	2109	2127	2145	2163	18 (Riser) + 2163 (U)	150	N/A
Leather 1 2850		Leather 2 2985		Leather 3 3120		Leather 4 3255		Leather 5 3390		Leather 6 3525		Leather 8 4695		COL 2019		S Nail 150		M Nail N/A	

Upholstery

**Pillows are not available on leather SKUs*

Fabric SKU: 1413-01

Leather SKU: N/A

Standard Pillows: N/A Finish Req: N

Standard Cushions: Ultra Plush Standard Finish: Traditional

COM: 11 yards COL: N/A

Milan Lounge Chair

Width: 35.5 Depth: 41 Height: 39.5

AH: 25 SH: 20 SD: 22 IW: 21

Weight: 75 lbs Cube: 40.81

D	E	F	G	H	J	K COM	L	M	N	O	P	Q	R	S	T	U	(# above U) *	S Nail	M Nail
2670	2706	2742	2778	2814	2850	2886	2922	2958	2994	3030	3066	3102	3138	3174	3210	3246	36 (Riser) + 3246 (U)	N/A	N/A
Leather 1 N/A		Leather 2 N/A		Leather 3 N/A		Leather 4 N/A		Leather 5 N/A		Leather 6 N/A		Leather 8 N/A		COL N/A		S Nail N/A		M Nail N/A	

Fabric SKU: 1413-20

Leather SKU: N/A

Standard Pillows: N/A Finish Req: N

Standard Cushions: High Resiliency 20 Standard Finish: Traditional

COM: 5 yards COL: N/A

Milan Ottoman

Width: 31 Depth: 24 Height: 18.5

AH: 0 SH: 0 SD: 0 IW: 0

Weight: 30 lbs Cube: 13.69

D	E	F	G	H	J	K COM	L	M	N	O	P	Q	R	S	T	U	(# above U) *	S Nail	M Nail
1245	1260	1275	1290	1305	1320	1335	1350	1365	1380	1395	1410	1425	1440	1455	1470	1485	15 (Riser) + 1485 (U)	N/A	N/A
Leather 1 N/A		Leather 2 N/A		Leather 3 N/A		Leather 4 N/A		Leather 5 N/A		Leather 6 N/A		Leather 8 N/A		COL N/A		S Nail N/A		M Nail N/A	

Fabric SKU: 1413-31

Leather SKU: N/A

Standard Pillows: N/A Finish Req: N

Standard Cushions: Ultra Plush Standard Finish:

COM: 11 yards COL: N/A

Milan Swivel Chair

Width: 35.5 Depth: 41 Height: 39.5

AH: 25 SH: 20 SD: 22 IW: 21

Weight: 85 lbs Cube: 40.81

D	E	F	G	H	J	K COM	L	M	N	O	P	Q	R	S	T	U	(# above U) *	S Nail	M Nail
2745	2781	2817	2853	2889	2925	2961	2997	3033	3069	3105	3141	3177	3213	3249	3285	3321	36 (Riser) + 3321 (U)	N/A	N/A
Leather 1 N/A		Leather 2 N/A		Leather 3 N/A		Leather 4 N/A		Leather 5 N/A		Leather 6 N/A		Leather 8 N/A		COL N/A		S Nail N/A		M Nail N/A	

Fabric SKU: 1413-32

Leather SKU: N/A

Standard Pillows: N/A Finish Req: N

Standard Cushions: Ultra Plush Standard Finish:

COM: 11 yards COL: N/A

Milan Swivel Glider

Width: 35.5 Depth: 41 Height: 39.5

AH: 25 SH: 20 SD: 22 IW: 21

Weight: 85 lbs Cube: 40.81

D	E	F	G	H	J	K COM	L	M	N	O	P	Q	R	S	T	U	(# above U) *	S Nail	M Nail
2895	2931	2967	3003	3039	3075	3111	3147	3183	3219	3255	3291	3327	3363	3399	3435	3471	36 (Riser) + 3471 (U)	N/A	N/A
Leather 1 N/A		Leather 2 N/A		Leather 3 N/A		Leather 4 N/A		Leather 5 N/A		Leather 6 N/A		Leather 8 N/A		COL N/A		S Nail N/A		M Nail N/A	

Fabric SKU: 1417-01

Leather SKU: N/A

Standard Pillows: N/A Finish Req: Y

Standard Cushions: Ultra Plush Standard Finish:

COM: 6.25 yards COL: N/A

Jean-Michel Lounge Chair

Width: 30.5 Depth: 36 Height: 34

AH: 24 SH: 20 SD: 20.5 IW: 23

Weight: 60 lbs Cube: 29.69

D	E	F	G	H	J	K COM	L	M	N	O	P	Q	R	S	T	U	(# above U) *	S Nail	M Nail
2550	2568	2586	2604	2622	2640	2658	2676	2694	2712	2730	2748	2766	2784	2802	2820	2838	18 (Riser) + 2838 (U)	75	N/A
Leather 1 N/A		Leather 2 N/A		Leather 3 N/A		Leather 4 N/A		Leather 5 N/A		Leather 6 N/A		Leather 8 N/A		COL N/A		S Nail N/A		M Nail N/A	

Fabric SKU: 1417-50

Leather SKU: N/A

Standard Pillows: (2) 20 x 20 Finish Req: Y

Standard Cushions: Ultra Plush Standard Finish:

COM: 14.75 yards COL: N/A

Jean-Michel Sofa

Width: 76 Depth: 36 Height: 34

AH: 24 SH: 20 SD: 20.5 IW: 69

Weight: 113 lbs Cube: 70.78

D	E	F	G	H	J	K COM	L	M	N	O	P	Q	R	S	T	U	(# above U) *	S Nail	M Nail
4455	4500	4545	4590	4635	4680	4725	4770	4815	4860	4905	4950	4995	5040	5085	5130	5175	45 (Riser) + 5175 (U)	105	N/A
Leather 1 N/A		Leather 2 N/A		Leather 3 N/A		Leather 4 N/A		Leather 5 N/A		Leather 6 N/A		Leather 8 N/A		COL N/A		S Nail N/A		M Nail N/A	

Upholstery

**Pillows are not available on leather SKUs*

Fabric SKU: 1418-01

Leather SKU: L-1418-01

Standard Pillows: N/A Finish Req: N

Standard Cushions: High Resiliency 40 Standard Finish:

COM: 4.5 yards COL: 79 square feet

Nova Arm Chair

Width: 24.5 Depth: 25 Height: 31.5

AH: 25 SH: 19 SD: 19 IW: 19.5

Weight: 40 lbs Cube: 11.16

D	E	F	G	H	J	K COM	L	M	N	O	P	Q	R	S	T	U	(# above U) *	S Nail	M Nail
1785	1800	1815	1830	1845	1860	1875	1890	1905	1920	1935	1950	1965	1980	1995	2010	2025	15 (Riser) + 2025 (U)	75	N/A
Leather 1 2775		Leather 2 2895		Leather 3 3015		Leather 4 3135		Leather 5 3255		Leather 6 3375		Leather 8 4470		COL 1905		S Nail 75		M Nail N/A	

Fabric SKU: 1418-04

Leather SKU: L-1418-04

Standard Pillows: N/A Finish Req: N

Standard Cushions: High Resiliency 40 Standard Finish:

COM: 4.5 yards COL: 79 square feet

"Standard with Casters for easy mobility.

Nova Arm Chair

with five casters

Width: 24.5 Depth: 25 Height: 31.5

AH: 25 SH: 19 SD: 19 IW: 19.5

Weight: 40 lbs Cube: 15.74

D	E	F	G	H	J	K COM	L	M	N	O	P	Q	R	S	T	U	(# above U) *	S Nail	M Nail
1785	1800	1815	1830	1845	1860	1875	1890	1905	1920	1935	1950	1965	1980	1995	2010	2025	15 (Riser) + 2025 (U)	75	N/A
Leather 1 2775		Leather 2 2895		Leather 3 3015		Leather 4 3135		Leather 5 3255		Leather 6 3375		Leather 8 4470		COL 1905		S Nail 75		M Nail N/A	

Fabric SKU: 1424-01

Leather SKU: L-1424-01

Standard Pillows: N/A Finish Req: Y

Standard Cushions: Ultra Plush Standard Finish:

COM: 7.5 yards COL: 135 square feet

Presley Lounge Chair

Width: 35 Depth: 39 Height: 39.5

AH: 24 SH: 19 SD: 20.5 IW: 19.5

Weight: 80 lbs Cube: 31.2

D	E	F	G	H	J	K COM	L	M	N	O	P	Q	R	S	T	U	(# above U) *	S Nail	M Nail
2685	2706	2727	2748	2769	2790	2811	2832	2853	2874	2895	2916	2937	2958	2979	3000	3021	21 (Riser) + 3021 (U)	45	60
Leather 1 4455		Leather 2 4665		Leather 3 4875		Leather 4 5085		Leather 5 5295		Leather 6 5505		Leather 8 7365		COL 2853		S Nail 45		M Nail 60	

Fabric SKU: 1424-20

Leather SKU: L-1424-20

Standard Pillows: N/A Finish Req: Y

Standard Cushions: High Resiliency 30 Standard Finish:

COM: 2.75 yards COL: 57 square feet

Presley Ottoman

Width: 26.25 Depth: 21 Height: 16.5

AH: 0 SH: 0 SD: 0 IW: 0

Weight: 26 lbs Cube: 5.26

D	E	F	G	H	J	K COM	L	M	N	O	P	Q	R	S	T	U	(# above U) *	S Nail	M Nail
1155	1164	1173	1182	1191	1200	1209	1218	1227	1236	1245	1254	1263	1272	1281	1290	1299	9 (Riser) + 1299 (U)	30	45
Leather 1 1950		Leather 2 2040		Leather 3 2130		Leather 4 2220		Leather 5 2310		Leather 6 2400		Leather 8 3195		COL 1227		S Nail 30		M Nail 45	

Fabric SKU: 1424-59

Leather SKU: L-1424-59

Standard Pillows: N/A Finish Req: Y

Standard Cushions: Ultra Plush Standard Finish:

COM: 8.75 yards COL: 147 square feet

Presley Tilt-Back Chair

Width: 35 Depth: 39 Height: 39.5

AH: 24 SH: 19 SD: 20.5 IW: 19.5

Weight: 96 lbs Cube: 31.2

D	E	F	G	H	J	K COM	L	M	N	O	P	Q	R	S	T	U	(# above U) *	S Nail	M Nail
3225	3249	3273	3297	3321	3345	3369	3393	3417	3441	3465	3489	3513	3537	3561	3585	3609	24 (Riser) + 3609 (U)	45	60
Leather 1 5025		Leather 2 5250		Leather 3 5475		Leather 4 5700		Leather 5 5925		Leather 6 6150		Leather 8 8175		COL 3417		S Nail 45		M Nail 60	

Fabric SKU: 1425-01

Leather SKU: N/A

Standard Pillows: N/A Finish Req: N

Standard Cushions: Ultra Plush Standard Finish: Traditional

COM: 11.5 yards COL: N/A

Chilton Lounge Chair

Width: 35.5 Depth: 40 Height: 44

AH: 26 SH: 20 SD: 20 IW: 21

Weight: 60 lbs Cube: 36.49

D	E	F	G	H	J	K COM	L	M	N	O	P	Q	R	S	T	U	(# above U) *	S Nail	M Nail
2670	2706	2742	2778	2814	2850	2886	2922	2958	2994	3030	3066	3102	3138	3174	3210	3246	36 (Riser) + 3246 (U)	N/A	N/A
Leather 1 N/A		Leather 2 N/A		Leather 3 N/A		Leather 4 N/A		Leather 5 N/A		Leather 6 N/A		Leather 8 N/A		COL N/A		S Nail N/A		M Nail N/A	

Upholstery

**Pillows are not available on leather SKUs*

Fabric SKU: 1425-20

Leather SKU: N/A

Standard Pillows: N/A Finish Req: N

Standard Cushions: High Resiliency 20 Standard Finish: Traditional

COM: 5 yards COL: N/A

Chilton Ottoman

Width: 31 Depth: 24 Height: 18.5

AH: 0 SH: 0 SD: 0 IW: 0

Weight: 30 lbs Cube: 10.77

D	E	F	G	H	J	K COM	L	M	N	O	P	Q	R	S	T	U	(# above U) *	S Nail	M Nail
1245	1260	1275	1290	1305	1320	1335	1350	1365	1380	1395	1410	1425	1440	1455	1470	1485	15 (Riser) + 1485 (U)	N/A	N/A
Leather 1 N/A		Leather 2 N/A		Leather 3 N/A		Leather 4 N/A		Leather 5 N/A		Leather 6 N/A		Leather 8 N/A		COL N/A		S Nail N/A		M Nail N/A	

Fabric SKU: 1425-31

Leather SKU: N/A

Standard Pillows: N/A Finish Req: N

Standard Cushions: Ultra Plush Standard Finish:

COM: 11.5 yards COL: N/A

Chilton Swivel Chair

Width: 35.5 Depth: 40 Height: 44

AH: 26 SH: 20 SD: 20 IW: 21

Weight: 60 lbs Cube: 41.32

D	E	F	G	H	J	K COM	L	M	N	O	P	Q	R	S	T	U	(# above U) *	S Nail	M Nail
2745	2781	2817	2853	2889	2925	2961	2997	3033	3069	3105	3141	3177	3213	3249	3285	3321	36 (Riser) + 3321 (U)	N/A	N/A
Leather 1 N/A		Leather 2 N/A		Leather 3 N/A		Leather 4 N/A		Leather 5 N/A		Leather 6 N/A		Leather 8 N/A		COL N/A		S Nail N/A		M Nail N/A	

Fabric SKU: 1425-32

Leather SKU: N/A

Standard Pillows: N/A Finish Req: N

Standard Cushions: Ultra Plush Standard Finish:

COM: 11.5 yards COL: N/A

Chilton Swivel Glider

Width: 35.5 Depth: 40 Height: 44

AH: 26 SH: 20 SD: 20 IW: 21

Weight: 60 lbs Cube: 41.32

D	E	F	G	H	J	K COM	L	M	N	O	P	Q	R	S	T	U	(# above U) *	S Nail	M Nail
2895	2931	2967	3003	3039	3075	3111	3147	3183	3219	3255	3291	3327	3363	3399	3435	3471	36 (Riser) + 3471 (U)	N/A	N/A
Leather 1 N/A		Leather 2 N/A		Leather 3 N/A		Leather 4 N/A		Leather 5 N/A		Leather 6 N/A		Leather 8 N/A		COL N/A		S Nail N/A		M Nail N/A	

Fabric SKU: 1426-01

Leather SKU: N/A

Standard Pillows: N/A Finish Req: N

Standard Cushions: Ultra Plush Standard Finish:

COM: 11.75 yards COL: N/A

Randolph Lounge Chair

Width: 32.5 Depth: 40 Height: 44

AH: 26 SH: 20 SD: 20 IW: 21

Weight: 55 lbs Cube: 41.32

D	E	F	G	H	J	K COM	L	M	N	O	P	Q	R	S	T	U	(# above U) *	S Nail	M Nail
2670	2706	2742	2778	2814	2850	2886	2922	2958	2994	3030	3066	3102	3138	3174	3210	3246	36 (Riser) + 3246 (U)	N/A	N/A
Leather 1 N/A		Leather 2 N/A		Leather 3 N/A		Leather 4 N/A		Leather 5 N/A		Leather 6 N/A		Leather 8 N/A		COL N/A		S Nail N/A		M Nail N/A	

Fabric SKU: 1426-20

Leather SKU: N/A

Standard Pillows: N/A Finish Req: N

Standard Cushions: Ultra Plush Standard Finish:

COM: 5 yards COL: N/A

Randolph Ottoman

Width: 31 Depth: 24 Height: 18.5

AH: 0 SH: 0 SD: 0 IW: 0

Weight: 30 lbs Cube: 10.77

D	E	F	G	H	J	K COM	L	M	N	O	P	Q	R	S	T	U	(# above U) *	S Nail	M Nail
1245	1260	1275	1290	1305	1320	1335	1350	1365	1380	1395	1410	1425	1440	1455	1470	1485	15 (Riser) + 1485 (U)	N/A	N/A
Leather 1 N/A		Leather 2 N/A		Leather 3 N/A		Leather 4 N/A		Leather 5 N/A		Leather 6 N/A		Leather 8 N/A		COL N/A		S Nail N/A		M Nail N/A	

Fabric SKU: 1426-31

Leather SKU: N/A

Standard Pillows: N/A Finish Req: N

Standard Cushions: Ultra Plush Standard Finish:

COM: 11.5 yards COL: N/A

Randolph Swivel Chair

Width: 32.5 Depth: 40 Height: 44

AH: 26 SH: 20 SD: 20 IW: 21

Weight: 55 lbs Cube: 41.32

D	E	F	G	H	J	K COM	L	M	N	O	P	Q	R	S	T	U	(# above U) *	S Nail	M Nail
2745	2781	2817	2853	2889	2925	2961	2997	3033	3069	3105	3141	3177	3213	3249	3285	3321	36 (Riser) + 3321 (U)	N/A	N/A
Leather 1 N/A		Leather 2 N/A		Leather 3 N/A		Leather 4 N/A		Leather 5 N/A		Leather 6 N/A		Leather 8 N/A		COL N/A		S Nail N/A		M Nail N/A	

Upholstery

**Pillows are not available on leather SKUs*

Fabric SKU: 1426-32

Leather SKU: N/A

Standard Pillows: N/A Finish Req: N

Standard Cushions: Ultra Plush Standard Finish:

COM: 11.5 yards COL: N/A

Randolph Swivel Glider

Width: 32.5 Depth: 40 Height: 44

AH: 26 SH: 20 SD: 20 IW: 21

Weight: 55 lbs Cube: 41.32

D	E	F	G	H	J	K COM	L	M	N	O	P	Q	R	S	T	U	(# above U) *	S Nail	M Nail
2895	2931	2967	3003	3039	3075	3111	3147	3183	3219	3255	3291	3327	3363	3399	3435	3471	36 (Riser) + 3471 (U)	N/A	N/A
Leather 1 N/A		Leather 2 N/A		Leather 3 N/A		Leather 4 N/A		Leather 5 N/A		Leather 6 N/A		Leather 8 N/A		COL N/A		S Nail N/A		M Nail N/A	

Fabric SKU: 1429-01

Leather SKU: N/A

Standard Pillows: N/A Finish Req: N

Standard Cushions: Ultra Plush Standard Finish: Traditional

COM: 7.75 yards COL: N/A

Holly Lounge Chair

Width: 29 Depth: 34.5 Height: 35

AH: 24.5 SH: 20.5 SD: 19.5 IW: 22.5

Weight: 65 lbs Cube: 29.29

D	E	F	G	H	J	K COM	L	M	N	O	P	Q	R	S	T	U	(# above U) *	S Nail	M Nail
2625	2649	2673	2697	2721	2745	2769	2793	2817	2841	2865	2889	2913	2937	2961	2985	3009	24 (Riser) + 3009 (U)	N/A	N/A
Leather 1 N/A		Leather 2 N/A		Leather 3 N/A		Leather 4 N/A		Leather 5 N/A		Leather 6 N/A		Leather 8 N/A		COL N/A		S Nail N/A		M Nail N/A	

Fabric SKU: 1429-31

Leather SKU: N/A

Standard Pillows: N/A Finish Req: N

Standard Cushions: Ultra Plush Standard Finish:

COM: 7.75 yards COL: N/A

Holly Swivel Chair

Width: 29 Depth: 34.5 Height: 35

AH: 24.5 SH: 20.5 SD: 19.5 IW: 22.5

Weight: 80 lbs Cube: 29.29

D	E	F	G	H	J	K COM	L	M	N	O	P	Q	R	S	T	U	(# above U) *	S Nail	M Nail
2700	2724	2748	2772	2796	2820	2844	2868	2892	2916	2940	2964	2988	3012	3036	3060	3084	24 (Riser) + 3084 (U)	N/A	N/A
Leather 1 N/A		Leather 2 N/A		Leather 3 N/A		Leather 4 N/A		Leather 5 N/A		Leather 6 N/A		Leather 8 N/A		COL N/A		S Nail N/A		M Nail N/A	

Fabric SKU: 1429-32

Leather SKU: N/A

Standard Pillows: N/A Finish Req: N

Standard Cushions: Ultra Plush Standard Finish:

COM: 7.75 yards COL: N/A

Holly Swivel Glider

Width: 29 Depth: 34.5 Height: 35

AH: 24.5 SH: 20.5 SD: 19.5 IW: 22.5

Weight: 65 lbs Cube: 33.92

D	E	F	G	H	J	K COM	L	M	N	O	P	Q	R	S	T	U	(# above U) *	S Nail	M Nail
2850	2874	2898	2922	2946	2970	2994	3018	3042	3066	3090	3114	3138	3162	3186	3210	3234	24 (Riser) + 3234 (U)	N/A	N/A
Leather 1 N/A		Leather 2 N/A		Leather 3 N/A		Leather 4 N/A		Leather 5 N/A		Leather 6 N/A		Leather 8 N/A		COL N/A		S Nail N/A		M Nail N/A	

Fabric SKU: 1430-01

Leather SKU: N/A

Standard Pillows: N/A Finish Req: Y

Standard Cushions: Ultra Plush Standard Finish:

COM: 7.25 yards COL: N/A

Holly Lounge Chair

Width: 29 Depth: 34.5 Height: 35

AH: 24.5 SH: 20.5 SD: 19.5 IW: 22.5

Weight: 60 lbs Cube: 29.29

D	E	F	G	H	J	K COM	L	M	N	O	P	Q	R	S	T	U	(# above U) *	S Nail	M Nail
2250	2274	2298	2322	2346	2370	2394	2418	2442	2466	2490	2514	2538	2562	2586	2610	2634	24 (Riser) + 2634 (U)	60	75
Leather 1 N/A		Leather 2 N/A		Leather 3 N/A		Leather 4 N/A		Leather 5 N/A		Leather 6 N/A		Leather 8 N/A		COL N/A		S Nail N/A		M Nail N/A	

Fabric SKU: 1431-01

Leather SKU: L-1431-01

Standard Pillows: N/A Finish Req: Y

Standard Cushions: High Resiliency 30 Standard Finish:

COM: 5 yards COL: 85 square feet

Chapman Lounge Chair

Width: 30.5 Depth: 32.25 Height: 35.75

AH: 23.25 SH: 19.25 SD: 21.25 IW: 22.5

Weight: 48 lbs Cube: 23.89

D	E	F	G	H	J	K COM	L	M	N	O	P	Q	R	S	T	U	(# above U) *	S Nail	M Nail
2100	2115	2130	2145	2160	2175	2190	2205	2220	2235	2250	2265	2280	2295	2310	2325	2340	15 (Riser) + 2340 (U)	75	90
Leather 1 3135		Leather 2 3270		Leather 3 3405		Leather 4 3540		Leather 5 3675		Leather 6 3810		Leather 8 4980		COL 2220		S Nail 75		M Nail 90	

Upholstery

**Pillows are not available on leather SKUs*

Fabric SKU: 1434-01

Leather SKU: L-1434-01

Standard Pillows: N/A Finish Req: Y

Standard Cushions: Ultra Plush Standard Finish:

COM: 6 yards COL: 102 square feet

Kyle Lounge Chair

Width: 28.5 Depth: 35 Height: 31.5

AH: 25.5 SH: 20 SD: 23 IW: 22

Weight: 65 lbs Cube: 29.69

D	E	F	G	H	J	K COM	L	M	N	O	P	Q	R	S	T	U	(# above U) *	S Nail	M Nail
2295	2313	2331	2349	2367	2385	2403	2421	2439	2457	2475	2493	2511	2529	2547	2565	2583	18 (Riser) + 2583 (U)	75	90
Leather 1 3630		Leather 2 3795		Leather 3 3960		Leather 4 4125		Leather 5 4290		Leather 6 4455		Leather 8 5865		COL 2439		S Nail 75		M Nail 90	

Fabric SKU: 1434-20

Leather SKU: L-1434-20

Standard Pillows: N/A Finish Req: Y

Standard Cushions: High Resiliency 30 Standard Finish:

COM: 2.25 yards COL: 40 square feet

Kyle Ottoman

Width: 26.5 Depth: 21 Height: 17.5

AH: 0 SH: 17.5 SD: 21 IW: 26.5

Weight: 21 lbs Cube: 10.77

D	E	F	G	H	J	K COM	L	M	N	O	P	Q	R	S	T	U	(# above U) *	S Nail	M Nail
960	966	972	978	984	990	996	1002	1008	1014	1020	1026	1032	1038	1044	1050	1056	6 (Riser) + 1056 (U)	30	45
Leather 1 1485		Leather 2 1545		Leather 3 1605		Leather 4 1665		Leather 5 1725		Leather 6 1785		Leather 8 2340		COL 1008		S Nail 30		M Nail 45	

Fabric SKU: 1434-MS-2

Leather SKU: L-1434-MS-2

Standard Pillows: N/A Finish Req: N

Standard Cushions: Ultra Plush Standard Finish: Nickel

COM: 6 yards COL: 102 square feet

Only available in Nickel finish

Kyle Memory Swivel Chair

Width: 28.5 Depth: 35 Height: 31.5

AH: 25.5 SH: 20 SD: 23 IW: 22

Weight: 65 lbs Cube: 29.69

D	E	F	G	H	J	K COM	L	M	N	O	P	Q	R	S	T	U	(# above U) *	S Nail	M Nail
2730	2748	2766	2784	2802	2820	2838	2856	2874	2892	2910	2928	2946	2964	2982	3000	3018	18 (Riser) + 3018 (U)	75	90
Leather 1 4125		Leather 2 4290		Leather 3 4455		Leather 4 4620		Leather 5 4785		Leather 6 4950		Leather 8 6360		COL 2874		S Nail 75		M Nail 90	

Fabric SKU: 1434-MS-6

Leather SKU: L-1434-MS-6

Standard Pillows: N/A Finish Req: N

Standard Cushions: Ultra Plush Standard Finish: Brushed Brass

COM: 6 yards COL: 102 square feet

Only available in Brushed Brass finish

Kyle Memory Swivel Chair

Width: 28.5 Depth: 35 Height: 31.5

AH: 25.5 SH: 20 SD: 23 IW: 22

Weight: 65 lbs Cube: 29.69

D	E	F	G	H	J	K COM	L	M	N	O	P	Q	R	S	T	U	(# above U) *	S Nail	M Nail
2730	2748	2766	2784	2802	2820	2838	2856	2874	2892	2910	2928	2946	2964	2982	3000	3018	18 (Riser) + 3018 (U)	75	90
Leather 1 4125		Leather 2 4290		Leather 3 4455		Leather 4 4620		Leather 5 4785		Leather 6 4950		Leather 8 6360		COL 2874		S Nail 75		M Nail 90	

Fabric SKU: 1435-01

Leather SKU: L-1435-01

Standard Pillows: N/A Finish Req: Y

Standard Cushions: Classic Plush Standard Finish:

COM: 4.5 yards COL: 79 square feet

La Brea Occasional Chair

Width: 27 Depth: 33.75 Height: 33.5

AH: 24 SH: 20.5 SD: 20 IW: 23.5

Weight: 34 lbs Cube: 17.66

D	E	F	G	H	J	K COM	L	M	N	O	P	Q	R	S	T	U	(# above U) *	S Nail	M Nail
2085	2100	2115	2130	2145	2160	2175	2190	2205	2220	2235	2250	2265	2280	2295	2310	2325	15 (Riser) + 2325 (U)	120	N/A
Leather 1 2985		Leather 2 3105		Leather 3 3225		Leather 4 3345		Leather 5 3465		Leather 6 3585		Leather 8 4680		COL 2205		S Nail 120		M Nail N/A	

Fabric SKU: 1439-01

Leather SKU: N/A

Standard Pillows: N/A Finish Req: Y

Standard Cushions: Blendown Standard Finish:

COM: 6.25 yards COL: N/A

Vivian Occasional Chair

Width: 30 Depth: 36.25 Height: 33

AH: 24 SH: 19.75 SD: 20 IW: 26.25

Weight: 54 lbs Cube: 29.69

D	E	F	G	H	J	K COM	L	M	N	O	P	Q	R	S	T	U	(# above U) *	S Nail	M Nail
2895	2913	2931	2949	2967	2985	3003	3021	3039	3057	3075	3093	3111	3129	3147	3165	3183	18 (Riser) + 3183 (U)	75	N/A
Leather 1 N/A		Leather 2 N/A		Leather 3 N/A		Leather 4 N/A		Leather 5 N/A		Leather 6 N/A		Leather 8 N/A		COL N/A		S Nail N/A		M Nail N/A	

Upholstery

**Pillows are not available on leather SKUs*

Fabric SKU: **1443-01**

Leather SKU: **N/A**

Standard Pillows: N/A Finish Req: N

Standard Cushions: Ultra Plush Standard Finish: Traditional

COM: 12 yards COL: N/A

Fairmont Lounge Chair

Width: 34 Depth: 41 Height: 38.5
 AH: 26 SH: 21.5 SD: 22.5 IW: 22.5
 Weight: 89 lbs Cube: 36.54

D	E	F	G	H	J	K COM	L	M	N	O	P	Q	R	S	T	U	(# above U) *	S Nail	M Nail
2610	2646	2682	2718	2754	2790	2826	2862	2898	2934	2970	3006	3042	3078	3114	3150	3186	36 (Riser) + 3186 (U)	N/A	N/A
Leather 1 N/A		Leather 2 N/A		Leather 3 N/A		Leather 4 N/A		Leather 5 N/A		Leather 6 N/A		Leather 8 N/A		COL N/A		S Nail N/A		M Nail N/A	

Fabric SKU: **1443-20**

Leather SKU: **N/A**

Standard Pillows: N/A Finish Req: N

Standard Cushions: High Resiliency 20 Standard Finish: Traditional

COM: 4.75 yards COL: N/A

Fairmont Ottoman

Width: 29.5 Depth: 23.5 Height: 20
 AH: 0 SH: 20 SD: 0 IW: 0
 Weight: 35 lbs Cube: 10.77

D	E	F	G	H	J	K COM	L	M	N	O	P	Q	R	S	T	U	(# above U) *	S Nail	M Nail
1125	1140	1155	1170	1185	1200	1215	1230	1245	1260	1275	1290	1305	1320	1335	1350	1365	15 (Riser) + 1365 (U)	N/A	N/A
Leather 1 N/A		Leather 2 N/A		Leather 3 N/A		Leather 4 N/A		Leather 5 N/A		Leather 6 N/A		Leather 8 N/A		COL N/A		S Nail N/A		M Nail N/A	

Fabric SKU: **1444-01**

Leather SKU: **L-1444-01**

Standard Pillows: N/A Finish Req: Y

Standard Cushions: Ultra Plush Standard Finish:

COM: 7.25 yards COL: 124 square feet

Edgeworth Wing Chair

Width: 32 Depth: 40 Height: 42.5
 AH: 25 SH: 20.5 SD: 19 IW: 20.5
 Weight: 65 lbs Cube: 31.48

D	E	F	G	H	J	K COM	L	M	N	O	P	Q	R	S	T	U	(# above U) *	S Nail	M Nail
2775	2790	2805	2820	2835	2850	2865	2880	2895	2910	2925	2940	2955	2970	2985	3000	3015	15 (Riser) + 3015 (U)	N/A	N/A
Leather 1 4290		Leather 2 4485		Leather 3 4680		Leather 4 4875		Leather 5 5070		Leather 6 5265		Leather 8 6975		COL 2895		S Nail N/A		M Nail N/A	

Fabric SKU: **1444-20**

Leather SKU: **L-1444-20**

Standard Pillows: N/A Finish Req: Y

Standard Cushions: High Resiliency 30 Standard Finish:

COM: 2.25 yards COL: 40 square feet

Edgeworth Ottoman

Width: 23.5 Depth: 19.25 Height: 18
 AH: 0 SH: 0 SD: 0 IW: 0
 Weight: 18 lbs Cube: 4.71

D	E	F	G	H	J	K COM	L	M	N	O	P	Q	R	S	T	U	(# above U) *	S Nail	M Nail
1185	1194	1203	1212	1221	1230	1239	1248	1257	1266	1275	1284	1293	1302	1311	1320	1329	9 (Riser) + 1329 (U)	N/A	N/A
Leather 1 1785		Leather 2 1845		Leather 3 1905		Leather 4 1965		Leather 5 2025		Leather 6 2085		Leather 8 2640		COL 1257		S Nail N/A		M Nail N/A	

Fabric SKU: **1447-01**

Leather SKU: **L-1447-01**

Standard Pillows: N/A Finish Req: Y

Standard Cushions: Ultra Plush Standard Finish:

COM: 5.5 yards COL: 85 square feet

Elgin Lounge Chair

Width: 27 Depth: 30 Height: 31
 AH: 24.5 SH: 20 SD: 20 IW: 20
 Weight: 35 lbs Cube: 21.65

D	E	F	G	H	J	K COM	L	M	N	O	P	Q	R	S	T	U	(# above U) *	S Nail	M Nail
2085	2100	2115	2130	2145	2160	2175	2190	2205	2220	2235	2250	2265	2280	2295	2310	2325	15 (Riser) + 2325 (U)	45	60
Leather 1 3225		Leather 2 3360		Leather 3 3495		Leather 4 3630		Leather 5 3765		Leather 6 3900		Leather 8 5070		COL 2205		S Nail 45		M Nail 60	

Fabric SKU: **1448-01**

Leather SKU: **L-1448-01**

Standard Pillows: N/A Finish Req: Y

Standard Cushions: Ultra Plush Standard Finish:

COM: 6.5 yards COL: 113 square feet

Grover Lounge Chair

Width: 30 Depth: 36.5 Height: 36.5
 AH: 24.5 SH: 20 SD: 24 IW: 20
 Weight: 60 lbs Cube: 29.69

D	E	F	G	H	J	K COM	L	M	N	O	P	Q	R	S	T	U	(# above U) *	S Nail	M Nail
2400	2418	2436	2454	2472	2490	2508	2526	2544	2562	2580	2598	2616	2634	2652	2670	2688	18 (Riser) + 2688 (U)	120	135
Leather 1 3795		Leather 2 3975		Leather 3 4155		Leather 4 4335		Leather 5 4515		Leather 6 4695		Leather 8 6255		COL 2544		S Nail 120		M Nail 135	

Upholstery

**Pillows are not available on leather SKUs*

Fabric SKU: **1448-31**

Leather SKU: **L-1448-31**

Standard Pillows: N/A Finish Req: N

Standard Cushions: Ultra Plush Standard Finish:

COM: 6.75 yards COL: 119 square feet

Grover Swivel Chair

Width: 30 Depth: 36.5 Height: 36.5

AH: 24.5 SH: 20 SD: 24 IW: 20

Weight: 71 lbs Cube: 29.69

D	E	F	G	H	J	K COM	L	M	N	O	P	Q	R	S	T	U	(# above U) *	S Nail	M Nail
2400	2418	2436	2454	2472	2490	2508	2526	2544	2562	2580	2598	2616	2634	2652	2670	2688	18 (Riser) + 2688 (U)	120	135
Leather 1 3795		Leather 2 3975		Leather 3 4155		Leather 4 4335		Leather 5 4515		Leather 6 4695		Leather 8 6330		COL 2544		S Nail 120		M Nail 135	

Fabric SKU: **1448-32**

Leather SKU: **L-1448-32**

Standard Pillows: N/A Finish Req: N

Standard Cushions: Ultra Plush Standard Finish:

COM: 6.75 yards COL: 119 square feet

Grover Swivel Glider

Width: 30 Depth: 36.5 Height: 36.5

AH: 24.5 SH: 20 SD: 24 IW: 20

Weight: 72 lbs Cube: 36.49

D	E	F	G	H	J	K COM	L	M	N	O	P	Q	R	S	T	U	(# above U) *	S Nail	M Nail
2550	2568	2586	2604	2622	2640	2658	2676	2694	2712	2730	2748	2766	2784	2802	2820	2838	18 (Riser) + 2838 (U)	120	135
Leather 1 3960		Leather 2 4140		Leather 3 4320		Leather 4 4500		Leather 5 4680		Leather 6 4860		Leather 8 6495		COL 2694		S Nail 120		M Nail 135	

Fabric SKU: **1452-01**

Leather SKU: **L-1452-01**

Standard Pillows: N/A Finish Req: Y

Standard Cushions: Ultra Plush Standard Finish:

COM: 6 yards COL: 113 square feet

Dellinger Lounge Chair

Width: 35 Depth: 36 Height: 35

AH: 25 SH: 19 SD: 24 IW: 20.5

Weight: 56 lbs Cube: 29.69

D	E	F	G	H	J	K COM	L	M	N	O	P	Q	R	S	T	U	(# above U) *	S Nail	M Nail
2625	2643	2661	2679	2697	2715	2733	2751	2769	2787	2805	2823	2841	2859	2877	2895	2913	18 (Riser) + 2913 (U)	N/A	N/A
Leather 1 4290		Leather 2 4470		Leather 3 4650		Leather 4 4830		Leather 5 5010		Leather 6 5190		Leather 8 6750		COL 2769		S Nail N/A		M Nail N/A	

Fabric SKU: **1452-20**

Leather SKU: **L-1452-20**

Standard Pillows: N/A Finish Req: Y

Standard Cushions: High Resiliency 35 Standard Finish:

COM: 2.5 yards COL: 40 square feet

Dellinger Ottoman

Width: 22.5 Depth: 19.5 Height: 16

AH: 0 SH: 0 SD: 0 IW: 0

Weight: 16 lbs Cube: 10.77

D	E	F	G	H	J	K COM	L	M	N	O	P	Q	R	S	T	U	(# above U) *	S Nail	M Nail
945	954	963	972	981	990	999	1008	1017	1026	1035	1044	1053	1062	1071	1080	1089	9 (Riser) + 1089 (U)	N/A	N/A
Leather 1 1485		Leather 2 1545		Leather 3 1605		Leather 4 1665		Leather 5 1725		Leather 6 1785		Leather 8 2340		COL 1017		S Nail N/A		M Nail N/A	

Fabric SKU: **1465-01**

Leather SKU: **L-1465-01**

Standard Pillows: N/A Finish Req: Y

Standard Cushions: Ultra Plush Standard Finish:

COM: 7.75 yards COL: 113 square feet

Keegan Lounge Chair

Width: 30.5 Depth: 38.5 Height: 34

AH: 23 SH: 18 SD: 22 IW: 24

Weight: 60 lbs Cube: 36.49

D	E	F	G	H	J	K COM	L	M	N	O	P	Q	R	S	T	U	(# above U) *	S Nail	M Nail
2520	2541	2562	2583	2604	2625	2646	2667	2688	2709	2730	2751	2772	2793	2814	2835	2856	21 (Riser) + 2856 (U)	75	90
Leather 1 3960		Leather 2 4140		Leather 3 4320		Leather 4 4500		Leather 5 4680		Leather 6 4860		Leather 8 6420		COL 2688		S Nail 75		M Nail 90	

Fabric SKU: **1465-20**

Leather SKU: **L-1465-20**

Standard Pillows: N/A Finish Req: Y

Standard Cushions: High Resiliency 20 Standard Finish:

COM: 2.5 yards COL: 40 square feet

Keegan Ottoman

Width: 25 Depth: 19 Height: 17

AH: 0 SH: 17 SD: 0 IW: 0

Weight: 24 lbs Cube: 10.77

D	E	F	G	H	J	K COM	L	M	N	O	P	Q	R	S	T	U	(# above U) *	S Nail	M Nail
1230	1239	1248	1257	1266	1275	1284	1293	1302	1311	1320	1329	1338	1347	1356	1365	1374	9 (Riser) + 1374 (U)	30	45
Leather 1 1815		Leather 2 1875		Leather 3 1935		Leather 4 1995		Leather 5 2055		Leather 6 2115		Leather 8 2670		COL 1302		S Nail 30		M Nail 45	

Upholstery

**Pillows are not available on leather SKUs*

Fabric SKU: 1467-01

Leather SKU: N/A

Standard Pillows: N/A Finish Req: N

Standard Cushions: Ultra Plush Standard Finish: Traditional

COM: 8.75 yards COL: N/A

Keegan Lounge Chair

Width: 30.5 Depth: 38.5 Height: 34

AH: 23 SH: 18 SD: 22 IW: 24

Weight: 73 lbs Cube: 36.49

D	E	F	G	H	J	K COM	L	M	N	O	P	Q	R	S	T	U	(# above U) *	S Nail	M Nail
2445	2469	2493	2517	2541	2565	2589	2613	2637	2661	2685	2709	2733	2757	2781	2805	2829	24 (Riser) + 2829 (U)	75	N/A
Leather 1 N/A		Leather 2 N/A		Leather 3 N/A		Leather 4 N/A		Leather 5 N/A		Leather 6 N/A		Leather 8 N/A		COL N/A		S Nail N/A		M Nail N/A	

Fabric SKU: 1467-20

Leather SKU: N/A

Standard Pillows: N/A Finish Req: N

Standard Cushions: High Resiliency 20 Standard Finish: Traditional

COM: 3.5 yards COL: N/A

Keegan Ottoman

Width: 25 Depth: 19 Height: 17

AH: 0 SH: 17 SD: 0 IW: 0

Weight: 24 lbs Cube: 10.77

D	E	F	G	H	J	K COM	L	M	N	O	P	Q	R	S	T	U	(# above U) *	S Nail	M Nail
1020	1029	1038	1047	1056	1065	1074	1083	1092	1101	1110	1119	1128	1137	1146	1155	1164	9 (Riser) + 1164 (U)	N/A	N/A
Leather 1 N/A		Leather 2 N/A		Leather 3 N/A		Leather 4 N/A		Leather 5 N/A		Leather 6 N/A		Leather 8 N/A		COL N/A		S Nail N/A		M Nail N/A	

Fabric SKU: 1467-31

Leather SKU: N/A

Standard Pillows: N/A Finish Req: N

Standard Cushions: Ultra Plush Standard Finish:

COM: 9 yards COL: N/A

Keegan Swivel Chair

Width: 30.5 Depth: 38.5 Height: 34

AH: 23 SH: 18 SD: 22 IW: 24

Weight: 75 lbs Cube: 36.49

D	E	F	G	H	J	K COM	L	M	N	O	P	Q	R	S	T	U	(# above U) *	S Nail	M Nail
2520	2544	2568	2592	2616	2640	2664	2688	2712	2736	2760	2784	2808	2832	2856	2880	2904	24 (Riser) + 2904 (U)	75	N/A
Leather 1 N/A		Leather 2 N/A		Leather 3 N/A		Leather 4 N/A		Leather 5 N/A		Leather 6 N/A		Leather 8 N/A		COL N/A		S Nail N/A		M Nail N/A	

Fabric SKU: 1467-32

Leather SKU: N/A

Standard Pillows: N/A Finish Req: N

Standard Cushions: Ultra Plush Standard Finish:

COM: 9 yards COL: N/A

Keegan Swivel Glider

Width: 30.5 Depth: 38.5 Height: 34

AH: 23 SH: 18 SD: 22 IW: 24

Weight: 90 lbs Cube: 36.49

D	E	F	G	H	J	K COM	L	M	N	O	P	Q	R	S	T	U	(# above U) *	S Nail	M Nail
2670	2694	2718	2742	2766	2790	2814	2838	2862	2886	2910	2934	2958	2982	3006	3030	3054	24 (Riser) + 3054 (U)	75	N/A
Leather 1 N/A		Leather 2 N/A		Leather 3 N/A		Leather 4 N/A		Leather 5 N/A		Leather 6 N/A		Leather 8 N/A		COL N/A		S Nail N/A		M Nail N/A	

Fabric SKU: 1470-01

Leather SKU: N/A

Standard Pillows: N/A Finish Req: Y

Standard Cushions: Ultra Plush Standard Finish:

COM: 5.25 yards COL: N/A

Benton Lounge Chair

Width: 31.5 Depth: 32.5 Height: 36

AH: 25.5 SH: 21 SD: 19.5 IW: 20.5

Weight: 55 lbs Cube: 23.22

D	E	F	G	H	J	K COM	L	M	N	O	P	Q	R	S	T	U	(# above U) *	S Nail	M Nail
2250	2265	2280	2295	2310	2325	2340	2355	2370	2385	2400	2415	2430	2445	2460	2475	2490	15 (Riser) + 2490 (U)	45	60
Leather 1 N/A		Leather 2 N/A		Leather 3 N/A		Leather 4 N/A		Leather 5 N/A		Leather 6 N/A		Leather 8 N/A		COL N/A		S Nail N/A		M Nail N/A	

Fabric SKU: 1485-01

Leather SKU: N/A

Standard Pillows: N/A Finish Req: Y

Standard Cushions: Ultra Plush Standard Finish:

COM: 6.75 yards COL: N/A

Standard with Nickel Finish Casters. Brushed Brass Available.

Leslie Occasional Chair

Width: 31.5 Depth: 38 Height: 39

AH: 25.5 SH: 21 SD: 22 IW: 24.5

Weight: 50 lbs Cube: 36.49

D	E	F	G	H	J	K COM	L	M	N	O	P	Q	R	S	T	U	(# above U) *	S Nail	M Nail
2250	2268	2286	2304	2322	2340	2358	2376	2394	2412	2430	2448	2466	2484	2502	2520	2538	18 (Riser) + 2538 (U)	45	60
Leather 1 N/A		Leather 2 N/A		Leather 3 N/A		Leather 4 N/A		Leather 5 N/A		Leather 6 N/A		Leather 8 N/A		COL N/A		S Nail N/A		M Nail N/A	

Upholstery

**Pillows are not available on leather SKUs*

Fabric SKU: **1486-01**

Leather SKU: **L-1486-01**

Standard Pillows: N/A Finish Req: Y

Standard Cushions: Ultra Plush Standard Finish:

COM: 6.75 yards COL: 107 square feet

Parisian Lounge Chair

Width: 36 Depth: 38 Height: 37.5

AH: 26 SH: 20 SD: 23.5 IW: 20

Weight: 64 lbs Cube: 36.49

D	E	F	G	H	J	K COM	L	M	N	O	P	Q	R	S	T	U	(# above U) *	S Nail	M Nail
2925	2946	2967	2988	3009	3030	3051	3072	3093	3114	3135	3156	3177	3198	3219	3240	3261	21 (Riser) + 3261 (U)	N/A	N/A
Leather 1 4275		Leather 2 4440		Leather 3 4605		Leather 4 4770		Leather 5 4935		Leather 6 5100		Leather 8 6570		COL 3093		S Nail N/A		M Nail N/A	

Fabric SKU: **1486-20**

Leather SKU: **L-1486-20**

Standard Pillows: N/A Finish Req: Y

Standard Cushions: High Resiliency 30 Standard Finish:

COM: 2 yards COL: 40 square feet

Parisian Ottoman

Width: 25.5 Depth: 20.5 Height: 16

AH: 0 SH: 0 SD: 0 IW: 0

Weight: 21 lbs Cube: 4.84

D	E	F	G	H	J	K COM	L	M	N	O	P	Q	R	S	T	U	(# above U) *	S Nail	M Nail
975	981	987	993	999	1005	1011	1017	1023	1029	1035	1041	1047	1053	1059	1065	1071	6 (Riser) + 1071 (U)	N/A	N/A
Leather 1 1485		Leather 2 1545		Leather 3 1605		Leather 4 1665		Leather 5 1725		Leather 6 1785		Leather 8 2340		COL 1023		S Nail N/A		M Nail N/A	

Fabric SKU: **1487-01**

Leather SKU: **L-1487-01**

Standard Pillows: N/A Finish Req: Y

Standard Cushions: Ultra Plush Standard Finish:

COM: 6.5 yards COL: 107 square feet

De Long Lounge Chair

Width: 30.75 Depth: 34 Height: 32

AH: 25.75 SH: 19.5 SD: 20 IW: 23

Weight: 69 lbs Cube: 29.69

D	E	F	G	H	J	K COM	L	M	N	O	P	Q	R	S	T	U	(# above U) *	S Nail	M Nail
2625	2643	2661	2679	2697	2715	2733	2751	2769	2787	2805	2823	2841	2859	2877	2895	2913	18 (Riser) + 2913 (U)	N/A	N/A
Leather 1 4050		Leather 2 4215		Leather 3 4380		Leather 4 4545		Leather 5 4710		Leather 6 4875		Leather 8 6345		COL 2769		S Nail N/A		M Nail N/A	

Fabric SKU: **1487-31**

Leather SKU: **L-1487-31**

Standard Pillows: N/A Finish Req: Y

Standard Cushions: Ultra Plush Standard Finish:

COM: 6.5 yards COL: 107 square feet

De Long Swivel Chair

Width: 30.75 Depth: 34 Height: 32

AH: 25.75 SH: 19.5 SD: 20 IW: 23

Weight: 79 lbs Cube: 19.36

D	E	F	G	H	J	K COM	L	M	N	O	P	Q	R	S	T	U	(# above U) *	S Nail	M Nail
2700	2718	2736	2754	2772	2790	2808	2826	2844	2862	2880	2898	2916	2934	2952	2970	2988	18 (Riser) + 2988 (U)	N/A	N/A
Leather 1 4125		Leather 2 4290		Leather 3 4455		Leather 4 4620		Leather 5 4785		Leather 6 4950		Leather 8 6420		COL 2844		S Nail N/A		M Nail N/A	

Fabric SKU: **1490-01**

Leather SKU: **L-1490-01**

Standard Pillows: N/A Finish Req: Y

Standard Cushions: Blendown Standard Finish:

COM: 4 yards COL: 74 square feet

Oxford Lounge Chair

Width: 29 Depth: 32 Height: 32

AH: 22.5 SH: 18.75 SD: 22.5 IW: 19

Weight: 37 lbs Cube: 23.89

D	E	F	G	H	J	K COM	L	M	N	O	P	Q	R	S	T	U	(# above U) *	S Nail	M Nail
2145	2157	2169	2181	2193	2205	2217	2229	2241	2253	2265	2277	2289	2301	2313	2325	2337	12 (Riser) + 2337 (U)	Std.	N/A
Leather 1 3060		Leather 2 3180		Leather 3 3300		Leather 4 3420		Leather 5 3540		Leather 6 3660		Leather 8 4680		COL 2241		S Nail Std.		M Nail N/A	

Fabric SKU: **1495-01**

Leather SKU: **L-1495-01**

Standard Pillows: N/A Finish Req: Y

Standard Cushions: Ultra Plush Standard Finish:

COM: 5 yards COL: 85 square feet

Dresden Lounge Chair

Width: 29 Depth: 30 Height: 32.75

AH: 25 SH: 20 SD: 20 IW: 20

Weight: 48 lbs Cube: 21.65

D	E	F	G	H	J	K COM	L	M	N	O	P	Q	R	S	T	U	(# above U) *	S Nail	M Nail
2160	2175	2190	2205	2220	2235	2250	2265	2280	2295	2310	2325	2340	2355	2370	2385	2400	15 (Riser) + 2400 (U)	60	75
Leather 1 3375		Leather 2 3510		Leather 3 3645		Leather 4 3780		Leather 5 3915		Leather 6 4050		Leather 8 5220		COL 2280		S Nail Std.		M Nail 15	

Upholstery

**Pillows are not available on leather SKUs*

Fabric SKU: 1495-20

Leather SKU: L-1495-20

Standard Pillows: N/A Finish Req: Y

Standard Cushions: High Resiliency 35 Standard Finish:

COM: 1.75 yards COL: 34 square feet

Dresden Ottoman

Width: 22.5 Depth: 19.5 Height: 17

AH: 0 SH: 0 SD: 0 IW: 0

Weight: 17 lbs Cube: 10.77

D	E	F	G	H	J	K COM	L	M	N	O	P	Q	R	S	T	U	(# above U) *	S Nail	M Nail
930	936	942	948	954	960	966	972	978	984	990	996	1002	1008	1014	1020	1026	6 (Riser) + 1026 (U)	30	N/A
Leather 1 1440		Leather 2 1500		Leather 3 1560		Leather 4 1620		Leather 5 1680		Leather 6 1740		Leather 8 2205		COL 978		S Nail Std.		M Nail N/A	

Fabric SKU: 1495-59

Leather SKU: L-1495-59

Standard Pillows: N/A Finish Req: Y

Standard Cushions: Ultra Plush Standard Finish:

COM: 5.25 yards COL: 96 square feet

Dresden Tilt Back

Width: 29 Depth: 32 Height: 36.75

AH: 25 SH: 20 SD: 20 IW: 20

Weight: 61 lbs Cube: 27.3

D	E	F	G	H	J	K COM	L	M	N	O	P	Q	R	S	T	U	(# above U) *	S Nail	M Nail
2685	2700	2715	2730	2745	2760	2775	2790	2805	2820	2835	2850	2865	2880	2895	2910	2925	15 (Riser) + 2925 (U)	60	75
Leather 1 3960		Leather 2 4110		Leather 3 4260		Leather 4 4410		Leather 5 4560		Leather 6 4710		Leather 8 6030		COL 2805		S Nail Std.		M Nail 15	

Fabric SKU: 1500-20

Leather SKU: L-1500-20

Standard Pillows: N/A Finish Req: N

Standard Cushions: High Resiliency 30 Standard Finish: Traditional

COM: 3.5 yards COL: 40 square feet

Cameron Ottoman

Width: 23 Depth: 23 Height: 18

AH: 0 SH: 0 SD: 0 IW: 0

Weight: 18 lbs Cube: 10.77

D	E	F	G	H	J	K COM	L	M	N	O	P	Q	R	S	T	U	(# above U) *	S Nail	M Nail
975	987	999	1011	1023	1035	1047	1059	1071	1083	1095	1107	1119	1131	1143	1155	1167	12 (Riser) + 1167 (U)	Std.	N/A
Leather 1 1500		Leather 2 1560		Leather 3 1620		Leather 4 1680		Leather 5 1740		Leather 6 1800		Leather 8 2355		COL 1071		S Nail Std.		M Nail N/A	

Fabric SKU: 1515-20

Leather SKU: L-1515-20

Standard Pillows: N/A Finish Req: N

Standard Cushions: High Resiliency 35 Standard Finish: Traditional

COM: 2.5 yards COL: 51 square feet

Anniston Ottoman

Width: 20.5 Depth: 20.5 Height: 20

AH: 0 SH: 0 SD: 0 IW: 0

Weight: 30 lbs Cube: 10.77

D	E	F	G	H	J	K COM	L	M	N	O	P	Q	R	S	T	U	(# above U) *	S Nail	M Nail
1350	1359	1368	1377	1386	1395	1404	1413	1422	1431	1440	1449	1458	1467	1476	1485	1494	9 (Riser) + 1494 (U)	Std.	N/A
Leather 1 2010		Leather 2 2085		Leather 3 2160		Leather 4 2235		Leather 5 2310		Leather 6 2385		Leather 8 3090		COL 1422		S Nail Std.		M Nail N/A	

Fabric SKU: 1520-20

Leather SKU: N/A

Standard Pillows: N/A Finish Req: N

Standard Cushions: High Resiliency 55 Standard Finish:

COM: 2.5 yards COL: N/A

Ressler Pouf Ottoman

Width: 27.5 Depth: 27.5 Height: 19

AH: 0 SH: 0 SD: 0 IW: 0

Weight: 11 lbs Cube: 13.69

D	E	F	G	H	J	K COM	L	M	N	O	P	Q	R	S	T	U	(# above U) *	S Nail	M Nail
675	675	675	675	675	720	720	720	720	720	765	765	765	765	765	810	810	45 (Riser) + 810 (U)	N/A	N/A
Leather 1 N/A		Leather 2 N/A		Leather 3 N/A		Leather 4 N/A		Leather 5 N/A		Leather 6 N/A		Leather 8 N/A		COL N/A		S Nail #N/A		M Nail #N/A	

Fabric SKU: 1552-20

Leather SKU: L-1552-20

Standard Pillows: N/A Finish Req: N

Standard Cushions: High Resiliency 30 Standard Finish: Traditional

COM: 2.25 yards COL: 40 square feet

Kipley Pouf Ottoman

Width: 19 Depth: 19 Height: 19.5

AH: 0 SH: 0 SD: 0 IW: 0

Weight: 28 lbs Cube: 10.77

D	E	F	G	H	J	K COM	L	M	N	O	P	Q	R	S	T	U	(# above U) *	S Nail	M Nail
960	969	978	987	996	1005	1014	1023	1032	1041	1050	1059	1068	1077	1086	1095	1104	9 (Riser) + 1104 (U)	Std.	N/A
Leather 1 1575		Leather 2 1635		Leather 3 1695		Leather 4 1755		Leather 5 1815		Leather 6 1875		Leather 8 2430		COL 1032		S Nail Std.		M Nail N/A	

Upholstery

**Pillows are not available on leather SKUs*

Fabric SKU: 1572-22

Leather SKU: L-1572-22

Standard Pillows: N/A Finish Req: N

Standard Cushions: High Resiliency 30 Standard Finish: Traditional

COM: 2 yards COL: 45 square feet

Interior painted black and features a lift-off lid

Amby Storage Ottoman

Width: 18.5 Depth: 18.5 Height: 20.5

AH: 0 SH: 0 SD: 0 IW: 0

Weight: 35 lbs Cube: 10.77

D	E	F	G	H	J	K COM	L	M	N	O	P	Q	R	S	T	U	(# above U) *	S Nail	M Nail
1005	1011	1017	1023	1029	1035	1041	1047	1053	1059	1065	1071	1077	1083	1089	1095	1101	6 (Riser) + 1101 (U)	Std.	N/A
Leather 1 1680		Leather 2 1755		Leather 3 1830		Leather 4 1905		Leather 5 1980		Leather 6 2055		Leather 8 2685		COL 1053		S Nail Std.		M Nail N/A	

Fabric SKU: 1599-20

Leather SKU: N/A

Standard Pillows: N/A Finish Req: N

Standard Cushions: High Resiliency 30 Standard Finish:

COM: N/A yards COL: N/A

Fully upholstered Muslin Ottoman with a Mango, solid wood base finished in natural. Pairs with 1599-SC-P slipcover.

Muslin Ottoman

Width: 18.5 Depth: 18.5 Height: 18.5

AH: 0 SH: 0 SD: 0 IW: 0

Weight: 29 lbs Cube: 5.48

D	E	F	G	H	J	K COM	L	M	N	O	P	Q	R	S	T	U	(# above U) *	S Nail	M Nail
795	N/A	N/A	N/A	N/A	N/A	N/A	N/A	N/A	N/A	N/A	N/A	N/A	N/A	N/A	N/A	N/A	N/A (Riser) + N/A (U)	N/A	N/A
Leather 1 N/A		Leather 2 N/A		Leather 3 N/A		Leather 4 N/A		Leather 5 N/A		Leather 6 N/A		Leather 8 N/A		COL N/A		S Nail N/A		M Nail N/A	

Fabric SKU: 1599-SC-P

Leather SKU: N/A

Standard Pillows: N/A Finish Req: N

Standard Cushions: N/A Standard Finish:

COM: N/A yards COL: N/A

Pairs the 1599-20 Muslin Ottoman.

Muslin Ottoman Slipcover

Width: 18.5 Depth: 18.5 Height: 18.5

AH: 0 SH: 0 SD: 0 IW: 0

Weight: 2 lbs Cube: 0.87

D	E	F	G	H	J	K COM	L	M	N	O	P	Q	R	S	T	U	(# above U) *	S Nail	M Nail
450	N/A	N/A	N/A	N/A	N/A	N/A	N/A	N/A	N/A	N/A	N/A	N/A	N/A	N/A	N/A	N/A	N/A (Riser) + N/A (U)	N/A	N/A
Leather 1 N/A		Leather 2 N/A		Leather 3 N/A		Leather 4 N/A		Leather 5 N/A		Leather 6 N/A		Leather 8 N/A		COL N/A		S Nail N/A		M Nail N/A	

Fabric SKU: 1601-10

Leather SKU: L-1601-10

Standard Pillows: N/A Finish Req: Y

Standard Cushions: High Resiliency 40 Standard Finish:

COM: 3.75 yards COL: 59.5 square feet

Snyder Bench

Width: 51 Depth: 22 Height: 32

AH: 27 SH: 19.5 SD: 19 IW: 46

Weight: 45 lbs Cube: 21.33

D	E	F	G	H	J	K COM	L	M	N	O	P	Q	R	S	T	U	(# above U) *	S Nail	M Nail
2100	2112	2124	2136	2148	2160	2172	2184	2196	2208	2220	2232	2244	2256	2268	2280	2292	12 (Riser) + 2292 (U)	N/A	N/A
Leather 1 2895		Leather 2 2985		Leather 3 3075		Leather 4 3165		Leather 5 3255		Leather 6 3345		Leather 8 4170		COL 2196		S Nail N/A		M Nail N/A	

Fabric SKU: 1603-10

Leather SKU: L-1603-10

Standard Pillows: N/A Finish Req: Y

Standard Cushions: High Resiliency 40 Standard Finish:

COM: 4 yards COL: 74 square feet

Luna Bench

Width: 56 Depth: 22 Height: 26.5

AH: 26.5 SH: 19.5 SD: 22 IW: 48

Weight: 55 lbs Cube: 23.16

D	E	F	G	H	J	K COM	L	M	N	O	P	Q	R	S	T	U	(# above U) *	S Nail	M Nail
1845	1857	1869	1881	1893	1905	1917	1929	1941	1953	1965	1977	1989	2001	2013	2025	2037	12 (Riser) + 2037 (U)	60	75
Leather 1 2730		Leather 2 2850		Leather 3 2970		Leather 4 3090		Leather 5 3210		Leather 6 3330		Leather 8 4350		COL 1941		S Nail 60		M Nail 75	

Fabric SKU: 1604-20

Leather SKU: L-1604-20

Standard Pillows: N/A Finish Req: N

Standard Cushions: High Resiliency 40 Standard Finish:

COM: 4.25 yards COL: 74 square feet

Kerbey Square Cocktail Ottoman

Width: 38.5 Depth: 38.5 Height: 16

AH: 0 SH: 16 SD: 0 IW: 0

Weight: 37 lbs Cube: 13.72

D	E	F	G	H	J	K COM	L	M	N	O	P	Q	R	S	T	U	(# above U) *	S Nail	M Nail
1050	1062	1074	1086	1098	1110	1122	1134	1146	1158	1170	1182	1194	1206	1218	1230	1242	12 (Riser) + 1242 (U)	N/A	N/A
Leather 1 1950		Leather 2 2070		Leather 3 2190		Leather 4 2310		Leather 5 2430		Leather 6 2550		Leather 8 3570		COL 1146		S Nail N/A		M Nail N/A	

Upholstery

**Pillows are not available on leather SKUs*

Fabric SKU: **1605-20**

Leather SKU: **L-1605-20**

Standard Pillows: N/A Finish Req: N

Standard Cushions: High Resiliency 40 Standard Finish:

COM: 4.25 yards COL: 68 square feet

Kilby Round Cocktail Ottoman

Width: 38.5 Depth: 38.5 Height: 15.25

AH: 0 SH: 15.25 SD: 0 IW: 0

Weight: 37 lbs Cube: 13.08

D	E	F	G	H	J	K COM	L	M	N	O	P	Q	R	S	T	U	(# above U) *	S Nail	M Nail
1050	1062	1074	1086	1098	1110	1122	1134	1146	1158	1170	1182	1194	1206	1218	1230	1242	12 (Riser) + 1242 (U)	N/A	N/A
Leather 1 1920		Leather 2 2025		Leather 3 2130		Leather 4 2235		Leather 5 2340		Leather 6 2445		Leather 8 3390		COL 1146		S Nail N/A		M Nail N/A	

Fabric SKU: **1606-20**

Leather SKU: **L-1606-20**

Standard Pillows: N/A Finish Req: N

Standard Cushions: High Resiliency 40 Standard Finish:

COM: 4.5 yards COL: 79 square feet

Shiloh Round Cocktail Ottoman

Width: 44.5 Depth: 44.5 Height: 15.25

AH: 0 SH: 15.25 SD: 0 IW: 0

Weight: 45 lbs Cube: 17.47

D	E	F	G	H	J	K COM	L	M	N	O	P	Q	R	S	T	U	(# above U) *	S Nail	M Nail
1125	1140	1155	1170	1185	1200	1215	1230	1245	1260	1275	1290	1305	1320	1335	1350	1365	15 (Riser) + 1365 (U)	N/A	N/A
Leather 1 2070		Leather 2 2190		Leather 3 2310		Leather 4 2430		Leather 5 2550		Leather 6 2670		Leather 8 3765		COL 1245		S Nail N/A		M Nail N/A	

Fabric SKU: **1611-10**

Leather SKU: **N/A**

Standard Pillows: N/A Finish Req: Y

Standard Cushions: High Resiliency 30 Standard Finish:

COM: 3.75 yards COL: N/A

Benson Bench

Width: 53.5 Depth: 18.5 Height: 26.5

AH: 26.5 SH: 19.5 SD: 18.5 IW: 41

Weight: 60 lbs Cube: 25.6

D	E	F	G	H	J	K COM	L	M	N	O	P	Q	R	S	T	U	(# above U) *	S Nail	M Nail
1665	1680	1695	1710	1725	1740	1755	1770	1785	1800	1815	1830	1845	1860	1875	1890	1905	15 (Riser) + 1905 (U)	45	60
Leather 1 N/A		Leather 2 N/A		Leather 3 N/A		Leather 4 N/A		Leather 5 N/A		Leather 6 N/A		Leather 8 N/A		COL N/A		S Nail N/A		M Nail N/A	

Fabric SKU: **1615-20**

Leather SKU: **L-1615-20**

Standard Pillows: N/A Finish Req: Y

Standard Cushions: High Resiliency 20 Standard Finish:

COM: 3.75 yards COL: 85 square feet

Roswell Cocktail Ottoman

Width: 33 Depth: 33 Height: 19.5

AH: 0 SH: 0 SD: 0 IW: 0

Weight: 45 lbs Cube: 16.92

D	E	F	G	H	J	K COM	L	M	N	O	P	Q	R	S	T	U	(# above U) *	S Nail	M Nail
1485	1500	1515	1530	1545	1560	1575	1590	1605	1620	1635	1650	1665	1680	1695	1710	1725	15 (Riser) + 1725 (U)	30	45
Leather 1 2400		Leather 2 2535		Leather 3 2670		Leather 4 2805		Leather 5 2940		Leather 6 3075		Leather 8 4245		COL 1605		S Nail 30		M Nail 45	

Fabric SKU: **1618-20**

Leather SKU: **L-1618-20**

Standard Pillows: N/A Finish Req: Y

Standard Cushions: High Resiliency 40 Standard Finish:

COM: 2 yards COL: 34.2 square feet

Stonewood Oval Cocktail Ottoman

Width: 38 Depth: 25.5 Height: 20

AH: 0 SH: 0 SD: 0 IW: 0

Weight: 45 lbs Cube: 20.21

D	E	F	G	H	J	K COM	L	M	N	O	P	Q	R	S	T	U	(# above U) *	S Nail	M Nail
1500	1506	1512	1518	1524	1530	1536	1542	1548	1554	1560	1566	1572	1578	1584	1590	1596	6 (Riser) + 1596 (U)	N/A	N/A
Leather 1 1980		Leather 2 2040		Leather 3 2100		Leather 4 2160		Leather 5 2220		Leather 6 2280		Leather 8 2760		COL 1548		S Nail N/A		M Nail N/A	

Fabric SKU: **1619-20**

Leather SKU: **L-1619-20**

Standard Pillows: N/A Finish Req: Y

Standard Cushions: High Resiliency 40 Standard Finish:

COM: 2.5 yards COL: 45 square feet

Cannon Cocktail Ottoman

Width: 18.5 Depth: 18.5 Height: 19.5

AH: 0 SH: 0 SD: 0 IW: 0

Weight: 25 lbs Cube: 10.77

D	E	F	G	H	J	K COM	L	M	N	O	P	Q	R	S	T	U	(# above U) *	S Nail	M Nail
1215	1224	1233	1242	1251	1260	1269	1278	1287	1296	1305	1314	1323	1332	1341	1350	1359	9 (Riser) + 1359 (U)	30	N/A
Leather 1 1815		Leather 2 1890		Leather 3 1965		Leather 4 2040		Leather 5 2115		Leather 6 2190		Leather 8 2820		COL 1287		S Nail 30		M Nail N/A	

Upholstery

**Pillows are not available on leather SKUs*

Fabric SKU: 1631-20

Leather SKU: L-1631-20

Standard Pillows: N/A Finish Req: Y

Standard Cushions: High Resiliency 40 Standard Finish:

COM: 4.5 yards COL: 62 square feet

Coordinates with 1632-20

Madeline Kidney Shaped Cocktail Ottoman

Width: 61 Depth: 32 Height: 16

AH: 0 SH: 0 SD: 0 IW: 0

Weight: 64 lbs Cube: 29.21

D	E	F	G	H	J	K COM	L	M	N	O	P	Q	R	S	T	U	(# above U) *	S Nail	M Nail
2085	2097	2109	2121	2133	2145	2157	2169	2181	2193	2205	2217	2229	2241	2253	2265	2277	12 (Riser) + 2277 (U)	45	60
Leather 1 2955		Leather 2 3060		Leather 3 3165		Leather 4 3270		Leather 5 3375		Leather 6 3480		Leather 8 4335		COL 2181		S Nail 45		M Nail 60	

Fabric SKU: 1632-20

Leather SKU: L-1632-20

Standard Pillows: N/A Finish Req: Y

Standard Cushions: High Resiliency 40 Standard Finish:

COM: 1.5 yards COL: 29 square feet

Coordinates with 1631-20.

Madeline Ottoman

Width: 18.5 Depth: 18.5 Height: 16

AH: 0 SH: 0 SD: 0 IW: 0

Weight: 20 lbs Cube: 10.77

D	E	F	G	H	J	K COM	L	M	N	O	P	Q	R	S	T	U	(# above U) *	S Nail	M Nail
1095	1104	1113	1122	1131	1140	1149	1158	1167	1176	1185	1194	1203	1212	1221	1230	1239	9 (Riser) + 1239 (U)	30	45
Leather 1 1650		Leather 2 1695		Leather 3 1740		Leather 4 1785		Leather 5 1830		Leather 6 1875		Leather 8 2280		COL 1167		S Nail 30		M Nail 45	

Fabric SKU: 1638-20

Leather SKU: L-1638-20

Standard Pillows: N/A Finish Req: Y

Standard Cushions: High Resiliency 30 Standard Finish:

COM: 3.5 yards COL: 57.6 square feet

Tray Dimensions: W 15 3/8" D14" H 2 7/8".

Haven Cocktail Ottoman

Width: 45 Depth: 45 Height: 21

AH: 0 SH: 21 SD: 45 IW: 0

Weight: 138 lbs Cube: 28.93

D	E	F	G	H	J	K COM	L	M	N	O	P	Q	R	S	T	U	(# above U) *	S Nail	M Nail
2445	2457	2469	2481	2493	2505	2517	2529	2541	2553	2565	2577	2589	2601	2613	2625	2637	12 (Riser) + 2637 (U)	120	N/A
Leather 1 3135		Leather 2 3225		Leather 3 3315		Leather 4 3405		Leather 5 3495		Leather 6 3585		Leather 8 4380		COL 2541		S Nail 120		M Nail N/A	

Fabric SKU: 1652-20

Leather SKU: N/A

Standard Pillows: N/A Finish Req: Y

Standard Cushions: High Resiliency 30 Standard Finish: Traditional

COM: 2.5 yards COL: N/A

Irving Bunching Ottoman

Width: 19 Depth: 19 Height: 20

AH: 0 SH: 0 SD: 0 IW: 0

Weight: 30 lbs Cube: 10.77

D	E	F	G	H	J	K COM	L	M	N	O	P	Q	R	S	T	U	(# above U) *	S Nail	M Nail
750	759	768	777	786	795	804	813	822	831	840	849	858	867	876	885	894	9 (Riser) + 894 (U)	30	45
Leather 1 N/A		Leather 2 N/A		Leather 3 N/A		Leather 4 N/A		Leather 5 N/A		Leather 6 N/A		Leather 8 N/A		COL N/A		S Nail N/A		M Nail N/A	

Fabric SKU: 1660-20

Leather SKU: N/A

Standard Pillows: N/A Finish Req: N

Standard Cushions: High Resiliency 20 Standard Finish: Traditional

COM: 4.75 yards COL: N/A

Alma Cocktail Ottoman

Width: 34.5 Depth: 34.5 Height: 19.5

AH: 0 SH: 0 SD: 0 IW: 0

Weight: 40 lbs Cube: 16.92

D	E	F	G	H	J	K COM	L	M	N	O	P	Q	R	S	T	U	(# above U) *	S Nail	M Nail
1560	1575	1590	1605	1620	1635	1650	1665	1680	1695	1710	1725	1740	1755	1770	1785	1800	15 (Riser) + 1800 (U)	N/A	N/A
Leather 1 N/A		Leather 2 N/A		Leather 3 N/A		Leather 4 N/A		Leather 5 N/A		Leather 6 N/A		Leather 8 N/A		COL N/A		S Nail N/A		M Nail N/A	

Fabric SKU: 1672-22

Leather SKU: L-1672-22

Standard Pillows: N/A Finish Req: N

Standard Cushions: High Resiliency 30 Standard Finish: Traditional

COM: 2.75 yards COL: 51 square feet

Features a Lift-off Lid

Kaplan Storage Ottoman

Width: 19 Depth: 19 Height: 21

AH: 0 SH: 0 SD: 0 IW: 0

Weight: 30 lbs Cube: 10.77

D	E	F	G	H	J	K COM	L	M	N	O	P	Q	R	S	T	U	(# above U) *	S Nail	M Nail
960	972	984	996	1008	1020	1032	1044	1056	1068	1080	1092	1104	1116	1128	1140	1152	12 (Riser) + 1152 (U)	30	45
Leather 1 1650		Leather 2 1725		Leather 3 1800		Leather 4 1875		Leather 5 1950		Leather 6 2025		Leather 8 2730		COL 1056		S Nail 30		M Nail 45	

Upholstery

**Pillows are not available on leather SKUs*

Fabric SKU: 1673-22

Leather SKU: N/A

Standard Pillows: N/A Finish Req: N

Standard Cushions: High Resiliency 30 Standard Finish: Traditional

COM: 3.5 yards COL: N/A

Features a Lift-off Lid

Linden Storage Ottoman

Width: 19 Depth: 19 Height: 21

AH: 0 SH: 0 SD: 0 IW: 0

Weight: 30 lbs Cube: 10.77

D	E	F	G	H	J	K COM	L	M	N	O	P	Q	R	S	T	U	(# above U) *	S Nail	M Nail
1170	1182	1194	1206	1218	1230	1242	1254	1266	1278	1290	1302	1314	1326	1338	1350	1362	12 (Riser) + 1362 (U)	N/A	N/A
Leather 1 N/A		Leather 2 N/A		Leather 3 N/A		Leather 4 N/A		Leather 5 N/A		Leather 6 N/A		Leather 8 N/A		COL N/A		S Nail N/A		M Nail N/A	

Fabric SKU: 1676-20

Leather SKU: L-1676-20

Standard Pillows: N/A Finish Req: Y

Standard Cushions: High Resiliency 30 Standard Finish:

COM: 3.75 yards COL: 63 square feet

Jenkins Cocktail Ottoman

Width: 36.5 Depth: 36.5 Height: 19

AH: 0 SH: 0 SD: 0 IW: 0

Weight: 40 lbs Cube: 16.92

D	E	F	G	H	J	K COM	L	M	N	O	P	Q	R	S	T	U	(# above U) *	S Nail	M Nail
1485	1497	1509	1521	1533	1545	1557	1569	1581	1593	1605	1617	1629	1641	1653	1665	1677	12 (Riser) + 1677 (U)	60	75
Leather 1 2340		Leather 2 2445		Leather 3 2550		Leather 4 2655		Leather 5 2760		Leather 6 2865		Leather 8 3735		COL 1581		S Nail 60		M Nail 75	

Fabric SKU: 1677-20

Leather SKU: L-1677-20

Standard Pillows: N/A Finish Req: Y

Standard Cushions: High Resiliency 35 Standard Finish:

COM: 3.25 yards COL: 57 square feet

Joplin Cocktail Ottoman

Width: 36.5 Depth: 36.5 Height: 20

AH: 0 SH: 0 SD: 0 IW: 0

Weight: 30 lbs Cube: 16.92

D	E	F	G	H	J	K COM	L	M	N	O	P	Q	R	S	T	U	(# above U) *	S Nail	M Nail
1320	1329	1338	1347	1356	1365	1374	1383	1392	1401	1410	1419	1428	1437	1446	1455	1464	9 (Riser) + 1464 (U)	45	60
Leather 1 2064		Leather 2 2154		Leather 3 2244		Leather 4 2334		Leather 5 2424		Leather 6 2514		Leather 8 3309		COL 1392		S Nail 45		M Nail 60	

Fabric SKU: 1685-10

Leather SKU: L-1685-10

Standard Pillows: N/A Finish Req: Y

Standard Cushions: Endurance Standard Finish:

COM: 6.25 yards COL: 102 square feet

Beacon Bench

Width: 55 Depth: 23 Height: 25

AH: 25 SH: 22 SD: 18.5 IW: 46

Weight: 60 lbs Cube: 26.76

D	E	F	G	H	J	K COM	L	M	N	O	P	Q	R	S	T	U	(# above U) *	S Nail	M Nail
2355	2373	2391	2409	2427	2445	2463	2481	2499	2517	2535	2553	2571	2589	2607	2625	2643	18 (Riser) + 2643 (U)	60	75
Leather 1 3585		Leather 2 3750		Leather 3 3915		Leather 4 4080		Leather 5 4245		Leather 6 4410		Leather 8 5820		COL 2499		S Nail 60		M Nail 75	

Fabric SKU: 1693-10

Leather SKU: N/A

Standard Pillows: N/A Finish Req: Y

Standard Cushions: High Resiliency 40 Standard Finish:

COM: 2 yards COL: N/A

Deerfield Bench

Width: 45.5 Depth: 18 Height: 20.5

AH: 0 SH: 0 SD: 0 IW: 0

Weight: 55 lbs Cube: 15.26

D	E	F	G	H	J	K COM	L	M	N	O	P	Q	R	S	T	U	(# above U) *	S Nail	M Nail
1155	1161	1167	1173	1179	1185	1191	1197	1203	1209	1215	1221	1227	1233	1239	1245	1251	6 (Riser) + 1251 (U)	45	60
Leather 1 N/A		Leather 2 N/A		Leather 3 N/A		Leather 4 N/A		Leather 5 N/A		Leather 6 N/A		Leather 8 N/A		COL N/A		S Nail N/A		M Nail N/A	

Fabric SKU: 1695-20

Leather SKU: N/A

Standard Pillows: N/A Finish Req: Y

Standard Cushions: High Resiliency 30 Standard Finish:

COM: 3.75 yards COL: N/A

Erwin Cocktail Ottoman

Width: 33 Depth: 33 Height: 22.5

AH: 0 SH: 0 SD: 0 IW: 0

Weight: 45 lbs Cube: 16.92

D	E	F	G	H	J	K COM	L	M	N	O	P	Q	R	S	T	U	(# above U) *	S Nail	M Nail
1425	1437	1449	1461	1473	1485	1497	1509	1521	1533	1545	1557	1569	1581	1593	1605	1617	12 (Riser) + 1617 (U)	45	60
Leather 1 N/A		Leather 2 N/A		Leather 3 N/A		Leather 4 N/A		Leather 5 N/A		Leather 6 N/A		Leather 8 N/A		COL N/A		S Nail N/A		M Nail N/A	

Upholstery

**Pillows are not available on leather SKUs*

Fabric SKU: 1700-10

Leather SKU: N/A

Standard Pillows: N/A Finish Req: Y

Standard Cushions: High Resiliency 40 Standard Finish:

COM: 4.75 yards COL: N/A

Maeve Bench

Width: 54.5 Depth: 20.5 Height: 26.5

AH: 26.5 SH: 19.5 SD: 17 IW: 48

Weight: 49 lbs Cube: 17.13

D	E	F	G	H	J	K COM	L	M	N	O	P	Q	R	S	T	U	(# above U) *	S Nail	M Nail
1875	1890	1905	1920	1935	1950	1965	1980	1995	2010	2025	2040	2055	2070	2085	2100	2115	15 (Riser) + 2115 (U)	75	N/A
Leather 1 N/A		Leather 2 N/A		Leather 3 N/A		Leather 4 N/A		Leather 5 N/A		Leather 6 N/A		Leather 8 N/A		COL N/A		S Nail N/A		M Nail N/A	

Fabric SKU: 1704-10

Leather SKU: L-1704-10

Standard Pillows: N/A Finish Req: Y

Standard Cushions: High Resiliency 40 Standard Finish:

COM: 2.75 yards COL: 45.9 square feet

Garfield Bench

Width: 47.5 Depth: 19 Height: 27.5

AH: 27.5 SH: 20 SD: 19 IW: 36

Weight: 40 lbs Cube: 15.26

D	E	F	G	H	J	K COM	L	M	N	O	P	Q	R	S	T	U	(# above U) *	S Nail	M Nail
1485	1494	1503	1512	1521	1530	1539	1548	1557	1566	1575	1584	1593	1602	1611	1620	1629	9 (Riser) + 1629 (U)	45	60
Leather 1 2220		Leather 2 2295		Leather 3 2370		Leather 4 2445		Leather 5 2520		Leather 6 2595		Leather 8 3225		COL 1557		S Nail 45		M Nail 60	

Fabric SKU: 1715-20

Leather SKU: N/A

Standard Pillows: N/A Finish Req: Y

Standard Cushions: High Resiliency 55 Standard Finish:

COM: 3.75 yards COL: N/A

Elizabella Cocktail Ottoman

Width: 37.5 Depth: 37.5 Height: 18.5

AH: 0 SH: 18.5 SD: 31 IW: 31

Weight: 50 lbs Cube: 15.05

D	E	F	G	H	J	K COM	L	M	N	O	P	Q	R	S	T	U	(# above U) *	S Nail	M Nail
1500	1512	1524	1536	1548	1560	1572	1584	1596	1608	1620	1632	1644	1656	1668	1680	1692	12 (Riser) + 1692 (U)	N/A	N/A
Leather 1 N/A		Leather 2 N/A		Leather 3 N/A		Leather 4 N/A		Leather 5 N/A		Leather 6 N/A		Leather 8 N/A		COL N/A		S Nail N/A		M Nail N/A	

Fabric SKU: 1724-10

Leather SKU: N/A

Standard Pillows: N/A Finish Req: Y

Standard Cushions: High Resiliency 40 Standard Finish:

COM: 3.5 yards COL: N/A

Hampton Bench

Width: 60 Depth: 19 Height: 28.5

AH: 28.5 SH: 22 SD: 19 IW: 48.5

Weight: 50 lbs Cube: 25.6

D	E	F	G	H	J	K COM	L	M	N	O	P	Q	R	S	T	U	(# above U) *	S Nail	M Nail
1680	1689	1698	1707	1716	1725	1734	1743	1752	1761	1770	1779	1788	1797	1806	1815	1824	9 (Riser) + 1824 (U)	45	60
Leather 1 N/A		Leather 2 N/A		Leather 3 N/A		Leather 4 N/A		Leather 5 N/A		Leather 6 N/A		Leather 8 N/A		COL N/A		S Nail N/A		M Nail N/A	

Fabric SKU: 1742-10

Leather SKU: L-1742-10

Standard Pillows: N/A Finish Req: Y

Standard Cushions: High Resiliency 40 Standard Finish:

COM: 4.25 yards COL: 72 square feet

Evie Bench

Width: 58 Depth: 23.5 Height: 26.5

AH: 26.5 SH: 19 SD: 18 IW: 46.5

Weight: 59 lbs Cube: 23.16

D	E	F	G	H	J	K COM	L	M	N	O	P	Q	R	S	T	U	(# above U) *	S Nail	M Nail
1950	1962	1974	1986	1998	2010	2022	2034	2046	2058	2070	2082	2094	2106	2118	2130	2142	12 (Riser) + 2142 (U)	75	90
Leather 1 2865		Leather 2 2985		Leather 3 3105		Leather 4 3225		Leather 5 3345		Leather 6 3465		Leather 8 4455		COL 2046		S Nail 75		M Nail 90	

Fabric SKU: 1750-10

Leather SKU: L-1750-10

Standard Pillows: N/A Finish Req: Y

Standard Cushions: High Resiliency 40 Standard Finish:

COM: 2.5 yards COL: 51 square feet

Inman Bench

Width: 58.5 Depth: 19 Height: 26

AH: 25.5 SH: 19 SD: 19 IW: 44.5

Weight: 40 lbs Cube: 25.6

D	E	F	G	H	J	K COM	L	M	N	O	P	Q	R	S	T	U	(# above U) *	S Nail	M Nail
1590	1599	1608	1617	1626	1635	1644	1653	1662	1671	1680	1689	1698	1707	1716	1725	1734	9 (Riser) + 1734 (U)	45	N/A
Leather 1 2235		Leather 2 2310		Leather 3 2385		Leather 4 2460		Leather 5 2535		Leather 6 2610		Leather 8 3315		COL 1662		S Nail 45		M Nail N/A	

Upholstery

**Pillows are not available on leather SKUs*

Fabric SKU: 1751-10

Leather SKU: L-1751-10

Standard Pillows: N/A Finish Req: Y

Standard Cushions: High Resiliency 40 Standard Finish:

COM: 4 yards COL: 63.75 square feet

Jena Bench

Width: 58 Depth: 22 Height: 27

AH: 27 SH: 18.5 SD: 17.5 IW: 48

Weight: 40 lbs Cube: 25.6

D	E	F	G	H	J	K COM	L	M	N	O	P	Q	R	S	T	U	(# above U) *	S Nail	M Nail
1890	1902	1914	1926	1938	1950	1962	1974	1986	1998	2010	2022	2034	2046	2058	2070	2082	12 (Riser) + 2082 (U)	45	N/A
Leather 1 2775		Leather 2 2880		Leather 3 2985		Leather 4 3090		Leather 5 3195		Leather 6 3300		Leather 8 4185		COL 1986		S Nail 45		M Nail N/A	

Fabric SKU: 1765-10

Leather SKU: N/A

Standard Pillows: N/A Finish Req: Y

Standard Cushions: High Resiliency 40 Standard Finish:

COM: 3.25 yards COL: N/A

Kenner Bench

Width: 55 Depth: 19 Height: 27

AH: 27 SH: 19 SD: 19 IW: 44

Weight: 40 lbs Cube: 25.6

D	E	F	G	H	J	K COM	L	M	N	O	P	Q	R	S	T	U	(# above U) *	S Nail	M Nail
1470	1479	1488	1497	1506	1515	1524	1533	1542	1551	1560	1569	1578	1587	1596	1605	1614	9 (Riser) + 1614 (U)	45	60
Leather 1 N/A		Leather 2 N/A		Leather 3 N/A		Leather 4 N/A		Leather 5 N/A		Leather 6 N/A		Leather 8 N/A		COL N/A		S Nail N/A		M Nail N/A	

Fabric SKU: 1766-10

Leather SKU: L-1766-10

Standard Pillows: N/A Finish Req: Y

Standard Cushions: High Resiliency 40 Standard Finish:

COM: 4 yards COL: 79 square feet

Lacey Bench

Width: 55 Depth: 21 Height: 26.5

AH: 26 SH: 19.5 SD: 18 IW: 43.5

Weight: 65 lbs Cube: 23.16

D	E	F	G	H	J	K COM	L	M	N	O	P	Q	R	S	T	U	(# above U) *	S Nail	M Nail
1725	1737	1749	1761	1773	1785	1797	1809	1821	1833	1845	1857	1869	1881	1893	1905	1917	12 (Riser) + 1917 (U)	45	60
Leather 1 2640		Leather 2 2760		Leather 3 2880		Leather 4 3000		Leather 5 3120		Leather 6 3240		Leather 8 4335		COL 1821		S Nail 45		M Nail 60	

Fabric SKU: 1770-10

Leather SKU: N/A

Standard Pillows: N/A Finish Req: Y

Standard Cushions: High Resiliency 40 Standard Finish:

COM: 2.25 yards COL: N/A

Malone Bench

Width: 51 Depth: 19 Height: 20.5

AH: 0 SH: 0 SD: 0 IW: 0

Weight: 35 lbs Cube: 21.76

D	E	F	G	H	J	K COM	L	M	N	O	P	Q	R	S	T	U	(# above U) *	S Nail	M Nail
1275	1284	1293	1302	1311	1320	1329	1338	1347	1356	1365	1374	1383	1392	1401	1410	1419	9 (Riser) + 1419 (U)	45	N/A
Leather 1 N/A		Leather 2 N/A		Leather 3 N/A		Leather 4 N/A		Leather 5 N/A		Leather 6 N/A		Leather 8 N/A		COL N/A		S Nail N/A		M Nail N/A	

Fabric SKU: 1777-10

Leather SKU: L-1777-10

Standard Pillows: N/A Finish Req: Y

Standard Cushions: High Resiliency 40 Standard Finish:

COM: 3.5 yards COL: 51 square feet

Lorain Bench

Width: 52.5 Depth: 21.5 Height: 19.5

AH: 0 SH: 0 SD: 0 IW: 0

Weight: 46 lbs Cube: 23.16

D	E	F	G	H	J	K COM	L	M	N	O	P	Q	R	S	T	U	(# above U) *	S Nail	M Nail
1485	1494	1503	1512	1521	1530	1539	1548	1557	1566	1575	1584	1593	1602	1611	1620	1629	9 (Riser) + 1629 (U)	60	75
Leather 1 2235		Leather 2 2310		Leather 3 2385		Leather 4 2460		Leather 5 2535		Leather 6 2610		Leather 8 3315		COL 1557		S Nail 60		M Nail 75	

Fabric SKU: 1786-10

Leather SKU: N/A

Standard Pillows: N/A Finish Req: Y

Standard Cushions: High Resiliency 40 Standard Finish:

COM: 4.75 yards COL: N/A

Lara Bench

Width: 54 Depth: 23 Height: 25.5

AH: 25 SH: 19 SD: 17.5 IW: 46

Weight: 55 lbs Cube: 23.16

D	E	F	G	H	J	K COM	L	M	N	O	P	Q	R	S	T	U	(# above U) *	S Nail	M Nail
1830	1845	1860	1875	1890	1905	1920	1935	1950	1965	1980	1995	2010	2025	2040	2055	2070	15 (Riser) + 2070 (U)	60	75
Leather 1 N/A		Leather 2 N/A		Leather 3 N/A		Leather 4 N/A		Leather 5 N/A		Leather 6 N/A		Leather 8 N/A		COL N/A		S Nail N/A		M Nail N/A	

Upholstery

**Pillows are not available on leather SKUs*

Fabric SKU: 1787-10

Leather SKU: N/A

Standard Pillows: N/A Finish Req: Y

Standard Cushions: High Resiliency 40 Standard Finish:

COM: 4.25 yards COL: N/A

Bradshaw Bench

Width: 54.5 Depth: 23.5 Height: 25

AH: 25 SH: 19 SD: 23.5 IW: 46

Weight: 47 lbs Cube: 23.16

D	E	F	G	H	J	K COM	L	M	N	O	P	Q	R	S	T	U	(# above U) *	S Nail	M Nail
1680	1692	1704	1716	1728	1740	1752	1764	1776	1788	1800	1812	1824	1836	1848	1860	1872	12 (Riser) + 1872 (U)	60	75
Leather 1 N/A		Leather 2 N/A		Leather 3 N/A		Leather 4 N/A		Leather 5 N/A		Leather 6 N/A		Leather 8 N/A		COL N/A		S Nail N/A		M Nail N/A	

Fabric SKU: 2000-07

Leather SKU: L-2000-07

Standard Pillows: N/A Finish Req: Y

Standard Cushions: High Resiliency 40 Standard Finish:

COM: 2.75 yards COL: 45 square feet

Features a Memory Swivel Seat and Sinuous Seating. Standard with two inch channel quilt on outside back.

Robroy Bar Stool

Width: 24.5 Depth: 24.5 Height: 46.5

AH: 33 SH: 30 SD: 19 IW: 19

Weight: 36 lbs Cube: 19.6

D	E	F	G	H	J	K COM	L	M	N	O	P	Q	R	S	T	U	(# above U) *	S Nail	M Nail
1725	1734	1743	1752	1761	1770	1779	1788	1797	1806	1815	1824	1833	1842	1851	1860	1869	9 (Riser) + 1869 (U)	45	N/A
Leather 1 2400		Leather 2 2475		Leather 3 2550		Leather 4 2625		Leather 5 2700		Leather 6 2775		Leather 8 3405		COL 1797		S Nail 45		M Nail N/A	

Fabric SKU: 2000-C7

Leather SKU: L-2000-C7

Standard Pillows: N/A Finish Req: Y

Standard Cushions: High Resiliency 40 Standard Finish:

COM: 2.75 yards COL: 45 square feet

Features a Memory Swivel Seat and Sinuous Seating. Standard with two inch channel quilt on outside back.

Robroy Counter Stool

Width: 24.5 Depth: 24.5 Height: 42.5

AH: 29 SH: 26 SD: 19 IW: 19

Weight: 35 lbs Cube: 19.6

D	E	F	G	H	J	K COM	L	M	N	O	P	Q	R	S	T	U	(# above U) *	S Nail	M Nail
1725	1734	1743	1752	1761	1770	1779	1788	1797	1806	1815	1824	1833	1842	1851	1860	1869	9 (Riser) + 1869 (U)	45	N/A
Leather 1 2400		Leather 2 2475		Leather 3 2550		Leather 4 2625		Leather 5 2700		Leather 6 2775		Leather 8 3405		COL 1797		S Nail 45		M Nail N/A	

Fabric SKU: 2001-07

Leather SKU: L-2001-07

Standard Pillows: N/A Finish Req: Y

Standard Cushions: High Resiliency 40 Standard Finish:

COM: 2.75 yards COL: 45 square feet

Features a Memory Swivel Seat and Sinuous Seating

Robroy Bar Stool

Width: 24.5 Depth: 24.5 Height: 46.5

AH: 33 SH: 30 SD: 19 IW: 19

Weight: 36 lbs Cube: 19.6

D	E	F	G	H	J	K COM	L	M	N	O	P	Q	R	S	T	U	(# above U) *	S Nail	M Nail
1695	1704	1713	1722	1731	1740	1749	1758	1767	1776	1785	1794	1803	1812	1821	1830	1839	9 (Riser) + 1839 (U)	45	N/A
Leather 1 2340		Leather 2 2415		Leather 3 2490		Leather 4 2565		Leather 5 2640		Leather 6 2715		Leather 8 3345		COL 1767		S Nail 45		M Nail N/A	

Fabric SKU: 2001-C7

Leather SKU: L-2001-C7

Standard Pillows: N/A Finish Req: Y

Standard Cushions: High Resiliency 40 Standard Finish:

COM: 2.75 yards COL: 45 square feet

Features a Memory Swivel Seat and Sinuous Seating

Robroy Counter Stool

Width: 24.5 Depth: 24.5 Height: 42.5

AH: 29 SH: 26 SD: 19 IW: 19

Weight: 35 lbs Cube: 19.6

D	E	F	G	H	J	K COM	L	M	N	O	P	Q	R	S	T	U	(# above U) *	S Nail	M Nail
1695	1704	1713	1722	1731	1740	1749	1758	1767	1776	1785	1794	1803	1812	1821	1830	1839	9 (Riser) + 1839 (U)	45	N/A
Leather 1 2340		Leather 2 2415		Leather 3 2490		Leather 4 2565		Leather 5 2640		Leather 6 2715		Leather 8 3345		COL 1767		S Nail 45		M Nail N/A	

Fabric SKU: 2002-07

Leather SKU: L-2002-07

Standard Pillows: N/A Finish Req: Y

Standard Cushions: High Resiliency 40 Standard Finish:

COM: 2.75 yards COL: 45 square feet

Features a Memory Swivel Seat

Vesper Bar Stool

Width: 24 Depth: 26 Height: 44

AH: 0 SH: 30 SD: 20 IW: 20.5

Weight: 35 lbs Cube: 19.6

D	E	F	G	H	J	K COM	L	M	N	O	P	Q	R	S	T	U	(# above U) *	S Nail	M Nail
1650	1659	1668	1677	1686	1695	1704	1713	1722	1731	1740	1749	1758	1767	1776	1785	1794	9 (Riser) + 1794 (U)	45	N/A
Leather 1 2265		Leather 2 2340		Leather 3 2415		Leather 4 2490		Leather 5 2565		Leather 6 2640		Leather 8 3270		COL 1722		S Nail 45		M Nail N/A	

Upholstery

**Pillows are not available on leather SKUs*

Fabric SKU: **2002-C7**

Leather SKU: **L-2002-C7**

Standard Pillows: N/A **Finish Req:** Y

Standard Cushions: High Resiliency 40 **Standard Finish:**

COM: 2.75 yards **COL:** 45 square feet

Features a Memory Swivel Seat and Sinuous Seating

Vesper Counter Stool

Width: 24 **Depth:** 26 **Height:** 20

AH: 0 **SH:** 26 **SD:** 20 **IW:** 20.5

Weight: 35 lbs **Cube:** 19.6

D	E	F	G	H	J	K COM	L	M	N	O	P	Q	R	S	T	U	(# above U) *	S Nail	M Nail
1650	1659	1668	1677	1686	1695	1704	1713	1722	1731	1740	1749	1758	1767	1776	1785	1794	9 (Riser) + 1794 (U)	45	N/A
Leather 1 2265		Leather 2 2340		Leather 3 2415		Leather 4 2490		Leather 5 2565		Leather 6 2640		Leather 8 3270		COL 1722		S Nail 45		M Nail N/A	

Fabric SKU: **2002-M7**

Leather SKU: **L-2002-M7**

Standard Pillows: N/A **Finish Req:** N

Standard Cushions: High Resiliency 40 **Standard Finish:** Nickel

COM: 2.75 yards **COL:** 45 square feet

360 Swivel. Adjustable height.

Vesper Billiard Bar Stool

Width: 24 **Depth:** 26 **Height:** 44

AH: 0 **SH:** 30 **SD:** 20 **IW:** 20.5

Weight: 35 lbs **Cube:** 24.14

D	E	F	G	H	J	K COM	L	M	N	O	P	Q	R	S	T	U	(# above U) *	S Nail	M Nail
2325	2334	2343	2352	2361	2370	2379	2388	2397	2406	2415	2424	2433	2442	2451	2460	2469	9 (Riser) + 2469 (U)	45	N/A
Leather 1 2865		Leather 2 2940		Leather 3 3015		Leather 4 3090		Leather 5 3165		Leather 6 3240		Leather 8 3870		COL 2397		S Nail 45		M Nail N/A	

Fabric SKU: **2003-06**

Leather SKU: **L-2003-06**

Standard Pillows: N/A **Finish Req:** Y

Standard Cushions: High Resiliency 40 **Standard Finish:**

COM: 3.25 yards **COL:** 51 square feet

Features a Memory Swivel Seat

Sidecar Bar Stool

Width: 21.5 **Depth:** 22.75 **Height:** 44.25

AH: 36 **SH:** 30 **SD:** 19.25 **IW:** 16.5

Weight: 33 lbs **Cube:** 19.6

D	E	F	G	H	J	K COM	L	M	N	O	P	Q	R	S	T	U	(# above U) *	S Nail	M Nail
1845	1854	1863	1872	1881	1890	1899	1908	1917	1926	1935	1944	1953	1962	1971	1980	1989	9 (Riser) + 1989 (U)	45	N/A
Leather 1 2610		Leather 2 2685		Leather 3 2760		Leather 4 2835		Leather 5 2910		Leather 6 2985		Leather 8 3690		COL 1917		S Nail 45		M Nail N/A	

Fabric SKU: **2003-C6**

Leather SKU: **L-2003-C6**

Standard Pillows: N/A **Finish Req:** Y

Standard Cushions: High Resiliency 40 **Standard Finish:**

COM: 3.25 yards **COL:** 51 square feet

Features a Memory Swivel Seat

Sidecar Counter Stool

Width: 21.5 **Depth:** 22.75 **Height:** 40.25

AH: 32 **SH:** 26 **SD:** 19.25 **IW:** 16.5

Weight: 32 lbs **Cube:** 15.74

D	E	F	G	H	J	K COM	L	M	N	O	P	Q	R	S	T	U	(# above U) *	S Nail	M Nail
1845	1854	1863	1872	1881	1890	1899	1908	1917	1926	1935	1944	1953	1962	1971	1980	1989	9 (Riser) + 1989 (U)	45	N/A
Leather 1 2610		Leather 2 2685		Leather 3 2760		Leather 4 2835		Leather 5 2910		Leather 6 2985		Leather 8 3690		COL 1917		S Nail 45		M Nail N/A	

Fabric SKU: **2004-06**

Leather SKU: **L-2004-06**

Standard Pillows: N/A **Finish Req:** Y

Standard Cushions: High Resiliency 40 **Standard Finish:**

COM: 2.25 yards **COL:** 40 square feet

Features a Memory Swivel Seat

Gimlet Bar Stool

Width: 22.5 **Depth:** 24.5 **Height:** 41.25

AH: 36 **SH:** 30 **SD:** 19.75 **IW:** 20.25

Weight: 34 lbs **Cube:** 19.6

D	E	F	G	H	J	K COM	L	M	N	O	P	Q	R	S	T	U	(# above U) *	S Nail	M Nail
1725	1734	1743	1752	1761	1770	1779	1788	1797	1806	1815	1824	1833	1842	1851	1860	1869	9 (Riser) + 1869 (U)	45	N/A
Leather 1 2280		Leather 2 2340		Leather 3 2400		Leather 4 2460		Leather 5 2520		Leather 6 2580		Leather 8 3135		COL 1797		S Nail 45		M Nail N/A	

Fabric SKU: **2004-C6**

Leather SKU: **L-2004-C6**

Standard Pillows: N/A **Finish Req:** Y

Standard Cushions: High Resiliency 40 **Standard Finish:**

COM: 2.25 yards **COL:** 40 square feet

Features a Memory Swivel Seat

Gimlet Counter Stool

Width: 22.5 **Depth:** 24.5 **Height:** 37.25

AH: 32 **SH:** 26 **SD:** 19.75 **IW:** 20.25

Weight: 34 lbs **Cube:** 15.74

D	E	F	G	H	J	K COM	L	M	N	O	P	Q	R	S	T	U	(# above U) *	S Nail	M Nail
1725	1734	1743	1752	1761	1770	1779	1788	1797	1806	1815	1824	1833	1842	1851	1860	1869	9 (Riser) + 1869 (U)	45	N/A
Leather 1 2280		Leather 2 2340		Leather 3 2400		Leather 4 2460		Leather 5 2520		Leather 6 2580		Leather 8 3135		COL 1797		S Nail 45		M Nail N/A	

Upholstery

**Pillows are not available on leather SKUs*

Fabric SKU: **2005-07**

Leather SKU: **L-2005-07**

Standard Pillows: N/A **Finish Req:** Y

Standard Cushions: High Resiliency 40 **Standard Finish:**

COM: 2.25 yards **COL:** 40 square feet

Features a Memory Swivel Seat

Cosmo Bar Stool

Width: 22 **Depth:** 22 **Height:** 36.75

AH: 36.75 **SH:** 30 **SD:** 18.75 **IW:** 17.5

Weight: 35 lbs **Cube:** 15.74

D	E	F	G	H	J	K COM	L	M	N	O	P	Q	R	S	T	U	(# above U) *	S Nail	M Nail
1620	1629	1638	1647	1656	1665	1674	1683	1692	1701	1710	1719	1728	1737	1746	1755	1764	9 (Riser) + 1764 (U)	45	N/A
Leather 1 2145		Leather 2 2205		Leather 3 2265		Leather 4 2325		Leather 5 2385		Leather 6 2445		Leather 8 3000		COL 1692		S Nail 45		M Nail N/A	

Fabric SKU: **2005-C7**

Leather SKU: **L-2005-C7**

Standard Pillows: N/A **Finish Req:** Y

Standard Cushions: High Resiliency 40 **Standard Finish:**

COM: 2.25 yards **COL:** 40 square feet

Features a Memory Swivel Seat

Cosmo Counter Stool

Width: 22 **Depth:** 22 **Height:** 32.75

AH: 32.75 **SH:** 26 **SD:** 18.75 **IW:** 17

Weight: 35 lbs **Cube:** 15.74

D	E	F	G	H	J	K COM	L	M	N	O	P	Q	R	S	T	U	(# above U) *	S Nail	M Nail
1620	1629	1638	1647	1656	1665	1674	1683	1692	1701	1710	1719	1728	1737	1746	1755	1764	9 (Riser) + 1764 (U)	45	N/A
Leather 1 2145		Leather 2 2205		Leather 3 2265		Leather 4 2325		Leather 5 2385		Leather 6 2445		Leather 8 3000		COL 1692		S Nail 45		M Nail N/A	

Fabric SKU: **2009-07**

Leather SKU: **L-2009-07**

Standard Pillows: N/A **Finish Req:** Y

Standard Cushions: High Resiliency 40 **Standard Finish:**

COM: 2 yards **COL:** 29 square feet

Juliet Bar Stool

Width: 21 **Depth:** 22 **Height:** 40.5

AH: 0 **SH:** 29.5 **SD:** 19 **IW:** 0

Weight: 25 lbs **Cube:** 17.77

D	E	F	G	H	J	K COM	L	M	N	O	P	Q	R	S	T	U	(# above U) *	S Nail	M Nail
1425	1431	1437	1443	1449	1455	1461	1467	1473	1479	1485	1491	1497	1503	1509	1515	1521	6 (Riser) + 1521 (U)	N/A	N/A
Leather 1 1980		Leather 2 2025		Leather 3 2070		Leather 4 2115		Leather 5 2160		Leather 6 2205		Leather 8 2610		COL 1473		S Nail N/A		M Nail N/A	

Fabric SKU: **2009-C7**

Leather SKU: **L-2009-C7**

Standard Pillows: N/A **Finish Req:** Y

Standard Cushions: High Resiliency 40 **Standard Finish:**

COM: 2 yards **COL:** 29 square feet

Juliet Counter Stool

Width: 21 **Depth:** 22 **Height:** 36.5

AH: 0 **SH:** 25.5 **SD:** 19 **IW:** 0

Weight: 25 lbs **Cube:** 15.74

D	E	F	G	H	J	K COM	L	M	N	O	P	Q	R	S	T	U	(# above U) *	S Nail	M Nail
1425	1431	1437	1443	1449	1455	1461	1467	1473	1479	1485	1491	1497	1503	1509	1515	1521	6 (Riser) + 1521 (U)	N/A	N/A
Leather 1 1980		Leather 2 2025		Leather 3 2070		Leather 4 2115		Leather 5 2160		Leather 6 2205		Leather 8 2610		COL 1473		S Nail N/A		M Nail N/A	

Fabric SKU: **2010-07**

Leather SKU: **L-2010-07**

Standard Pillows: N/A **Finish Req:** Y

Standard Cushions: High Resiliency 40 **Standard Finish:**

COM: 2.5 yards **COL:** 51 square feet

Memory Swivel Standard.

Bellini Bar Stool

Width: 22.5 **Depth:** 26 **Height:** 45

AH: 0 **SH:** 30 **SD:** 19 **IW:** 18.5

Weight: 38 lbs **Cube:** 15.23

D	E	F	G	H	J	K COM	L	M	N	O	P	Q	R	S	T	U	(# above U) *	S Nail	M Nail
1575	1584	1593	1602	1611	1620	1629	1638	1647	1656	1665	1674	1683	1692	1701	1710	1719	9 (Riser) + 1719 (U)	75	N/A
Leather 1 2175		Leather 2 2265		Leather 3 2355		Leather 4 2445		Leather 5 2535		Leather 6 2625		Leather 8 3420		COL 1647		S Nail 75		M Nail N/A	

Fabric SKU: **2010-C7**

Leather SKU: **L-2010-C7**

Standard Pillows: N/A **Finish Req:** Y

Standard Cushions: High Resiliency 40 **Standard Finish:**

COM: 2.5 yards **COL:** 51 square feet

Memory Swivel Standard.

Bellini Counter Stool

Width: 22.5 **Depth:** 26 **Height:** 41

AH: 0 **SH:** 26 **SD:** 19 **IW:** 18.5

Weight: 38 lbs **Cube:** 13.88

D	E	F	G	H	J	K COM	L	M	N	O	P	Q	R	S	T	U	(# above U) *	S Nail	M Nail
1575	1584	1593	1602	1611	1620	1629	1638	1647	1656	1665	1674	1683	1692	1701	1710	1719	9 (Riser) + 1719 (U)	75	N/A
Leather 1 2175		Leather 2 2265		Leather 3 2355		Leather 4 2445		Leather 5 2535		Leather 6 2625		Leather 8 3420		COL 1647		S Nail 75		M Nail N/A	

Upholstery

**Pillows are not available on leather SKUs*

Fabric SKU: 2011-05

Leather SKU: L-2011-05

Standard Pillows: N/A Finish Req: Y

Standard Cushions: High Resiliency 30 Standard Finish:

COM: 2 yards COL: 40 square feet

Magnolia Side Chair

Width: 21.75 Depth: 21 Height: 34

AH: 0 SH: 19 SD: 19 IW: 21.75

Weight: 16 lbs Cube: 8.98

D	E	F	G	H	J	K COM	L	M	N	O	P	Q	R	S	T	U	(# above U) *	S Nail	M Nail
1170	1176	1182	1188	1194	1200	1206	1212	1218	1224	1230	1236	1242	1248	1254	1260	1266	6 (Riser) + 1266 (U)	45	N/A
Leather 1 1740		Leather 2 1800		Leather 3 1860		Leather 4 1920		Leather 5 1980		Leather 6 2040		Leather 8 2595		COL 1218		S Nail 45		M Nail N/A	

Fabric SKU: 2012-06

Leather SKU: L-2012-06

Standard Pillows: N/A Finish Req: Y

Standard Cushions: High Resiliency 30 Standard Finish:

COM: 2.75 yards COL: 57 square feet

Allie Bar Stool

Width: 24.5 Depth: 21.25 Height: 39

AH: 39 SH: 31 SD: 19.5 IW: 18.5

Weight: 43 lbs Cube: 15.74

D	E	F	G	H	J	K COM	L	M	N	O	P	Q	R	S	T	U	(# above U) *	S Nail	M Nail
1980	1989	1998	2007	2016	2025	2034	2043	2052	2061	2070	2079	2088	2097	2106	2115	2124	9 (Riser) + 2124 (U)	N/A	N/A
Leather 1 2775		Leather 2 2865		Leather 3 2955		Leather 4 3045		Leather 5 3135		Leather 6 3225		Leather 8 4020		COL 2052		S Nail N/A		M Nail N/A	

Fabric SKU: 2012-C6

Leather SKU: L-2012-C6

Standard Pillows: N/A Finish Req: Y

Standard Cushions: High Resiliency 30 Standard Finish:

COM: 2.75 yards COL: 57 square feet

Allie Counter Stool

Width: 24.5 Depth: 21.25 Height: 35

AH: 35 SH: 27 SD: 19.5 IW: 18.5

Weight: 42 lbs Cube: 10.54

D	E	F	G	H	J	K COM	L	M	N	O	P	Q	R	S	T	U	(# above U) *	S Nail	M Nail
1980	1989	1998	2007	2016	2025	2034	2043	2052	2061	2070	2079	2088	2097	2106	2115	2124	9 (Riser) + 2124 (U)	N/A	N/A
Leather 1 2775		Leather 2 2865		Leather 3 2955		Leather 4 3045		Leather 5 3135		Leather 6 3225		Leather 8 4020		COL 2052		S Nail N/A		M Nail N/A	

Fabric SKU: 2014-07

Leather SKU: L-2014-07

Standard Pillows: N/A Finish Req: Y

Standard Cushions: High Resiliency 40 Standard Finish:

COM: 2 yards COL: 29 square feet

Features a memory swivel mechanism and a notched opening at the top back edge which provides a convenient holding spot.

Riley Bar Stool

Width: 22 Depth: 25.5 Height: 45.25

AH: 0 SH: 31.5 SD: 18.5 IW: 20.5

Weight: 30 lbs Cube: 14.69

D	E	F	G	H	J	K COM	L	M	N	O	P	Q	R	S	T	U	(# above U) *	S Nail	M Nail
1845	1851	1857	1863	1869	1875	1881	1887	1893	1899	1905	1911	1917	1923	1929	1935	1941	6 (Riser) + 1941 (U)	N/A	N/A
Leather 1 2265		Leather 2 2310		Leather 3 2355		Leather 4 2400		Leather 5 2445		Leather 6 2490		Leather 8 2895		COL 1893		S Nail N/A		M Nail N/A	

Fabric SKU: 2014-C7

Leather SKU: L-2014-C7

Standard Pillows: N/A Finish Req: Y

Standard Cushions: High Resiliency 40 Standard Finish:

COM: 2 yards COL: 29 square feet

Features a memory swivel mechanism and a notched opening at the top back edge which provides a convenient holding spot.

Riley Counter Stool

Width: 22 Depth: 25.5 Height: 41.25

AH: 0 SH: 27.5 SD: 18.5 IW: 20.5

Weight: 30 lbs Cube: 13.39

D	E	F	G	H	J	K COM	L	M	N	O	P	Q	R	S	T	U	(# above U) *	S Nail	M Nail
1845	1851	1857	1863	1869	1875	1881	1887	1893	1899	1905	1911	1917	1923	1929	1935	1941	6 (Riser) + 1941 (U)	N/A	N/A
Leather 1 2265		Leather 2 2310		Leather 3 2355		Leather 4 2400		Leather 5 2445		Leather 6 2490		Leather 8 2895		COL 1893		S Nail N/A		M Nail N/A	

Fabric SKU: 2015-07

Leather SKU: L-2015-07

Standard Pillows: N/A Finish Req: Y

Standard Cushions: High Resiliency 35 Standard Finish:

COM: 2.5 yards COL: 51 square feet

Riverside Drive Bar Stool

Width: 23.5 Depth: 22.5 Height: 48.5

AH: 43.5 SH: 31 SD: 17.5 IW: 23.5

Weight: 23 lbs Cube: 21.65

D	E	F	G	H	J	K COM	L	M	N	O	P	Q	R	S	T	U	(# above U) *	S Nail	M Nail
1755	1764	1773	1782	1791	1800	1809	1818	1827	1836	1845	1854	1863	1872	1881	1890	1899	9 (Riser) + 1899 (U)	Std.	N/A
Leather 1 2400		Leather 2 2475		Leather 3 2550		Leather 4 2625		Leather 5 2700		Leather 6 2775		Leather 8 3480		COL 1827		S Nail Std.		M Nail N/A	

Upholstery

**Pillows are not available on leather SKUs*

Fabric SKU: **2015-C7**

Leather SKU: **L-2015-C7**

Standard Pillows: N/A Finish Req: Y

Standard Cushions: High Resiliency 35 Standard Finish:

COM: 2.5 yards COL: 51 square feet

Riverside Drive Counter Stool

Width: 23.5 Depth: 22.5 Height: 44.5

AH: 39.5 SH: 27 SD: 17.5 IW: 23.5

Weight: 23 lbs Cube: 17.77

D	E	F	G	H	J	K COM	L	M	N	O	P	Q	R	S	T	U	(# above U) *	S Nail	M Nail
1755	1764	1773	1782	1791	1800	1809	1818	1827	1836	1845	1854	1863	1872	1881	1890	1899	9 (Riser) + 1899 (U)	Std.	N/A
Leather 1 2400		Leather 2 2475		Leather 3 2550		Leather 4 2625		Leather 5 2700		Leather 6 2775		Leather 8 3480		COL 1827		S Nail Std.		M Nail N/A	

Fabric SKU: **2016-07**

Leather SKU: **L-2016-07**

Standard Pillows: N/A Finish Req: Y

Standard Cushions: High Resiliency 40 Standard Finish:

COM: 2 yards COL: 40 square feet

Doyers Street Bar Stool

Width: 22.25 Depth: 21.75 Height: 38

AH: 0 SH: 31 SD: 17 IW: 22.25

Weight: 22 lbs Cube: 15.74

D	E	F	G	H	J	K COM	L	M	N	O	P	Q	R	S	T	U	(# above U) *	S Nail	M Nail
1650	1656	1662	1668	1674	1680	1686	1692	1698	1704	1710	1716	1722	1728	1734	1740	1746	6 (Riser) + 1746 (U)	Std.	N/A
Leather 1 2250		Leather 2 2310		Leather 3 2370		Leather 4 2430		Leather 5 2490		Leather 6 2550		Leather 8 3105		COL 1698		S Nail Std.		M Nail N/A	

Fabric SKU: **2016-C7**

Leather SKU: **L-2016-C7**

Standard Pillows: N/A Finish Req: Y

Standard Cushions: High Resiliency 40 Standard Finish:

COM: 2 yards COL: 40 square feet

Doyers Street Counter Stool

Width: 22.25 Depth: 21.75 Height: 34

AH: 0 SH: 27 SD: 17 IW: 22.25

Weight: 22 lbs Cube: 15.74

D	E	F	G	H	J	K COM	L	M	N	O	P	Q	R	S	T	U	(# above U) *	S Nail	M Nail
1650	1656	1662	1668	1674	1680	1686	1692	1698	1704	1710	1716	1722	1728	1734	1740	1746	6 (Riser) + 1746 (U)	Std.	N/A
Leather 1 2250		Leather 2 2310		Leather 3 2370		Leather 4 2430		Leather 5 2490		Leather 6 2550		Leather 8 3105		COL 1698		S Nail Std.		M Nail N/A	

Fabric SKU: **2017-06**

Leather SKU: **L-2017-06**

Standard Pillows: N/A Finish Req: Y

Standard Cushions: Endurance Standard Finish:

COM: 3.25 yards COL: 57 square feet

Finn Bar Stool

with Clean Out Seat

Width: 22 Depth: 22 Height: 41

AH: 34 SH: 30 SD: 18 IW: 18

Weight: 27 lbs Cube: 17.77

D	E	F	G	H	J	K COM	L	M	N	O	P	Q	R	S	T	U	(# above U) *	S Nail	M Nail
2085	2094	2103	2112	2121	2130	2139	2148	2157	2166	2175	2184	2193	2202	2211	2220	2229	9 (Riser) + 2229 (U)	60	N/A
Leather 1 2955		Leather 2 3045		Leather 3 3135		Leather 4 3225		Leather 5 3315		Leather 6 3405		Leather 8 4200		COL 2157		S Nail 60		M Nail N/A	

Fabric SKU: **2017-C6**

Leather SKU: **L-2017-C6**

Standard Pillows: N/A Finish Req: Y

Standard Cushions: Endurance Standard Finish:

COM: 3.25 yards COL: 57 square feet

Finn Counter Stool

with Clean Out Seat

Width: 22 Depth: 22 Height: 35

AH: 30 SH: 26 SD: 18 IW: 18

Weight: 27 lbs Cube: 15.74

D	E	F	G	H	J	K COM	L	M	N	O	P	Q	R	S	T	U	(# above U) *	S Nail	M Nail
2085	2094	2103	2112	2121	2130	2139	2148	2157	2166	2175	2184	2193	2202	2211	2220	2229	9 (Riser) + 2229 (U)	60	N/A
Leather 1 2955		Leather 2 3045		Leather 3 3135		Leather 4 3225		Leather 5 3315		Leather 6 3405		Leather 8 4200		COL 2157		S Nail N/A		M Nail N/A	

Fabric SKU: **2024-05**

Leather SKU: **L-2024-05**

Standard Pillows: N/A Finish Req: N

Standard Cushions: High Resiliency 40 Standard Finish:

COM: 4 yards COL: 68 square feet

Ivy Side Chair

Width: 22.5 Depth: 23.75 Height: 32

AH: 0 SH: 19.5 SD: 21 IW: 22.5

Weight: 36 lbs Cube: 9.89

D	E	F	G	H	J	K COM	L	M	N	O	P	Q	R	S	T	U	(# above U) *	S Nail	M Nail
1050	1065	1080	1095	1110	1125	1140	1155	1170	1185	1200	1215	1230	1245	1260	1275	1290	15 (Riser) + 1290 (U)	45	N/A
Leather 1 1950		Leather 2 2055		Leather 3 2160		Leather 4 2265		Leather 5 2370		Leather 6 2475		Leather 8 3420		COL 1170		S Nail 45		M Nail N/A	

Upholstery

**Pillows are not available on leather SKUs*

Fabric SKU: **2024-C7**

Leather SKU: **L-2024-C7**

Standard Pillows: N/A Finish Req: Y

Standard Cushions: High Resiliency 40 Standard Finish:

COM: 2 yards COL: 38 square feet

Ivy Swivel Counter Stool

Width: 19.5 Depth: 18.5 Height: 35

AH: 0 SH: 25 SD: 16.5 IW: 17.5

Weight: 21 lbs Cube: 7.3

D	E	F	G	H	J	K COM	L	M	N	O	P	Q	R	S	T	U	(# above U) *	S Nail	M Nail
1185	1191	1197	1203	1209	1215	1221	1227	1233	1239	1245	1251	1257	1263	1269	1275	1281	6 (Riser) + 1281 (U)	45	N/A
Leather 1 1650		Leather 2 1710		Leather 3 1770		Leather 4 1830		Leather 5 1890		Leather 6 1950		Leather 8 2475		COL 1233		S Nail 45		M Nail N/A	

Fabric SKU: **2024-C7-C**

Leather SKU: **L-2024-C7-C**

Standard Pillows: N/A Finish Req: N

Standard Cushions: High Resiliency 40 Standard Finish: Charcoal

COM: 2 yards COL: 38 square feet

Ivy Swivel Counter Stool

Charcoal Finish

Width: 19.5 Depth: 18.5 Height: 35

AH: 0 SH: 25 SD: 16.5 IW: 17.5

Weight: 21 lbs Cube: 7.3

D	E	F	G	H	J	K COM	L	M	N	O	P	Q	R	S	T	U	(# above U) *	S Nail	M Nail
1050	1056	1062	1068	1074	1080	1086	1092	1098	1104	1110	1116	1122	1128	1134	1140	1146	6 (Riser) + 1146 (U)	45	N/A
Leather 1 1485		Leather 2 1545		Leather 3 1605		Leather 4 1665		Leather 5 1725		Leather 6 1785		Leather 8 2310		COL 1098		S Nail 45		M Nail N/A	

Fabric SKU: **2024-S5**

Leather SKU: **L-2024-S5**

Standard Pillows: N/A Finish Req: N

Standard Cushions: High Resiliency 40 Standard Finish:

COM: 4 yards COL: 68 square feet

Ivy Side Chair

with Five casters

Width: 22.5 Depth: 23.75 Height: 32

AH: 0 SH: 19.5 SD: 21 IW: 22.5

Weight: 36 lbs Cube: 9.89

D	E	F	G	H	J	K COM	L	M	N	O	P	Q	R	S	T	U	(# above U) *	S Nail	M Nail
1080	1095	1110	1125	1140	1155	1170	1185	1200	1215	1230	1245	1260	1275	1290	1305	1320	15 (Riser) + 1320 (U)	45	N/A
Leather 1 1980		Leather 2 2085		Leather 3 2190		Leather 4 2295		Leather 5 2400		Leather 6 2505		Leather 8 3450		COL 1200		S Nail 45		M Nail N/A	

Fabric SKU: **2101-01**

Leather SKU: **L-2101-01**

Standard Pillows: N/A Finish Req: Y

Standard Cushions: High Resiliency 35 Standard Finish:

COM: 6.5 yards COL: 130 square feet

Dominique Lounge Chair

Hand Tufted

Width: 36 Depth: 33 Height: 31

AH: 30.5 SH: 19.5 SD: 22.5 IW: 22.25

Weight: 80 lbs Cube: 21.31

D	E	F	G	H	J	K COM	L	M	N	O	P	Q	R	S	T	U	(# above U) *	S Nail	M Nail
2685	2706	2727	2748	2769	2790	2811	2832	2853	2874	2895	2916	2937	2958	2979	3000	3021	21 (Riser) + 3021 (U)	150	N/A
Leather 1 4185		Leather 2 4290		Leather 3 4395		Leather 4 4500		Leather 5 4605		Leather 6 4710		Leather 8 5610		COL 2853		S Nail 150		M Nail N/A	

Fabric SKU: **2101-20**

Leather SKU: **L-2101-20**

Standard Pillows: N/A Finish Req: Y

Standard Cushions: High Resiliency 35 Standard Finish:

COM: 2.25 yards COL: 45 square feet

Dominique Ottoman

Hand Tufted

Width: 30 Depth: 24 Height: 17

AH: 0 SH: 17 SD: 24 IW: 30

Weight: 50 lbs Cube: 7.08

D	E	F	G	H	J	K COM	L	M	N	O	P	Q	R	S	T	U	(# above U) *	S Nail	M Nail
1197	1203	1209	1215	1221	1227	1233	1239	1245	1251	1257	1263	1269	1275	1281	1287	1293	6 (Riser) + 1293 (U)	60	N/A
Leather 1 1785		Leather 2 1830		Leather 3 1875		Leather 4 1920		Leather 5 1965		Leather 6 2010		Leather 8 2355		COL 1245		S Nail 60		M Nail N/A	

Fabric SKU: **2101-50**

Leather SKU: **L-2101-50**

Standard Pillows: (2) 20 x 20 Finish Req: Y

Standard Cushions: High Resiliency 35 Standard Finish:

COM: 12 yards COL: 209 square feet

Dominique Sofa

Hand Tufted

Width: 85 Depth: 34 Height: 30.5

AH: 30.5 SH: 19.5 SD: 22.5 IW: 72.25

Weight: 150 lbs Cube: 51

D	E	F	G	H	J	K COM	L	M	N	O	P	Q	R	S	T	U	(# above U) *	S Nail	M Nail
4200	4236	4272	4308	4344	4380	4416	4452	4488	4524	4560	4596	4632	4668	4704	4740	4776	36 (Riser) + 4776 (U)	240	N/A
Leather 1 6585		Leather 2 6735		Leather 3 6885		Leather 4 7035		Leather 5 7185		Leather 6 7335		Leather 8 8715		COL 4488		S Nail 240		M Nail N/A	

Upholstery

**Pillows are not available on leather SKUs*

Fabric SKU: 2101-56

Leather SKU: L-2101-56

Standard Pillows: (2) 20 x 20 Finish Req: Y

Standard Cushions: High Resiliency 35 Standard Finish:

COM: 12.75 yards COL: 231 square feet

Dominique Grande Sofa

Hand Tufted

Width: 90.25 Depth: 34.75 Height: 30.5

AH: 30.5 SH: 19.5 SD: 22.5 IW: 78.25

Weight: 150 lbs Cube: 55.35

D	E	F	G	H	J	K COM	L	M	N	O	P	Q	R	S	T	U	(# above U) *	S Nail	M Nail
4350	4398	4446	4494	4542	4590	4638	4686	4734	4782	4830	4878	4926	4974	5022	5070	5118	48 (Riser) + 5118 (U)	240	N/A
Leather 1 6885		Leather 2 7230		Leather 3 7575		Leather 4 7920		Leather 5 8265		Leather 6 8610		Leather 8 11790		COL 4734		S Nail 240		M Nail N/A	

Fabric SKU: 2101-70

Leather SKU: L-2101-70

Standard Pillows: (2) 20 x 20 Finish Req: Y

Standard Cushions: High Resiliency 35 Standard Finish:

COM: 10.5 yards COL: 180 square feet

Dominique Loveseat

Hand Tufted

Width: 68 Depth: 34 Height: 30.5

AH: 30.5 SH: 19.5 SD: 22.5 IW: 55.25

Weight: 110 lbs Cube: 40.8

D	E	F	G	H	J	K COM	L	M	N	O	P	Q	R	S	T	U	(# above U) *	S Nail	M Nail
4050	4080	4110	4140	4170	4200	4230	4260	4290	4320	4350	4380	4410	4440	4470	4500	4530	30 (Riser) + 4530 (U)	180	N/A
Leather 1 6285		Leather 2 6435		Leather 3 6585		Leather 4 6735		Leather 5 6885		Leather 6 7035		Leather 8 8340		COL 4290		S Nail 180		M Nail N/A	

Fabric SKU: 2102-26

Leather SKU: N/A

Standard Pillows: (1) 20 x 20 Finish Req: Y

Standard Cushions: Blendown Standard Finish:

COM: 11.75 yards COL: N/A

Avalon Right Arm Chaise

Width: 35 Depth: 41 Height: 35

AH: 31 SH: 20 SD: 22 IW: 30.25

Weight: 120 lbs Cube: 29.06

D	E	F	G	H	J	K COM	L	M	N	O	P	Q	R	S	T	U	(# above U) *	S Nail	M Nail
3450	3477	3504	3531	3558	3585	3612	3639	3666	3693	3720	3747	3774	3801	3828	3855	3882	27 (Riser) + 3882 (U)	135	N/A
Leather 1 N/A		Leather 2 N/A		Leather 3 N/A		Leather 4 N/A		Leather 5 N/A		Leather 6 N/A		Leather 8 N/A		COL N/A		S Nail N/A		M Nail N/A	

Fabric SKU: 2102-27

Leather SKU: N/A

Standard Pillows: (1) 20 x 20 Finish Req: Y

Standard Cushions: Blendown Standard Finish:

COM: 11.75 yards COL: N/A

Avalon Left Arm Chaise

Width: 35 Depth: 41 Height: 35

AH: 31 SH: 20 SD: 22 IW: 30.25

Weight: 120 lbs Cube: 29.06

D	E	F	G	H	J	K COM	L	M	N	O	P	Q	R	S	T	U	(# above U) *	S Nail	M Nail
3450	3477	3504	3531	3558	3585	3612	3639	3666	3693	3720	3747	3774	3801	3828	3855	3882	27 (Riser) + 3882 (U)	135	N/A
Leather 1 N/A		Leather 2 N/A		Leather 3 N/A		Leather 4 N/A		Leather 5 N/A		Leather 6 N/A		Leather 8 N/A		COL N/A		S Nail N/A		M Nail N/A	

Fabric SKU: 2102-51

Leather SKU: N/A

Standard Pillows: (1) 20 x 20 Finish Req: Y

Standard Cushions: Blendown Standard Finish:

COM: 21 yards COL: N/A

Avalon Right Arm Sofa

Width: 101.5 Depth: 41 Height: 35

AH: 31 SH: 20 SD: 22 IW: 96.75

Weight: 155 lbs Cube: 84.28

D	E	F	G	H	J	K COM	L	M	N	O	P	Q	R	S	T	U	(# above U) *	S Nail	M Nail
3900	3957	4014	4071	4128	4185	4242	4299	4356	4413	4470	4527	4584	4641	4698	4755	4812	57 (Riser) + 4812 (U)	165	N/A
Leather 1 N/A		Leather 2 N/A		Leather 3 N/A		Leather 4 N/A		Leather 5 N/A		Leather 6 N/A		Leather 8 N/A		COL N/A		S Nail N/A		M Nail N/A	

Fabric SKU: 2102-52

Leather SKU: N/A

Standard Pillows: (1) 20 x 20 Finish Req: Y

Standard Cushions: Blendown Standard Finish:

COM: 21 yards COL: N/A

Avalon Left Arm Sofa

Width: 101.5 Depth: 41 Height: 35

AH: 31 SH: 20 SD: 22 IW: 96.75

Weight: 155 lbs Cube: 84.28

D	E	F	G	H	J	K COM	L	M	N	O	P	Q	R	S	T	U	(# above U) *	S Nail	M Nail
3900	3957	4014	4071	4128	4185	4242	4299	4356	4413	4470	4527	4584	4641	4698	4755	4812	57 (Riser) + 4812 (U)	165	N/A
Leather 1 N/A		Leather 2 N/A		Leather 3 N/A		Leather 4 N/A		Leather 5 N/A		Leather 6 N/A		Leather 8 N/A		COL N/A		S Nail N/A		M Nail N/A	

Upholstery

**Pillows are not available on leather SKUs*

Fabric SKU: **2102-53**

Leather SKU: **N/A**

Standard Pillows: (3) 20 x 20 **Finish Req:** Y

Standard Cushions: Blendown **Standard Finish:**

COM: 23.5 yards **COL:** N/A

Avalon Right Arm Corner Sofa

Width: 108.25 **Depth:** 41 **Height:** 35

AH: 31 **SH:** 20 **SD:** 22 **IW:** 83.75

Weight: 165 lbs **Cube:** 89.89

D	E	F	G	H	J	K COM	L	M	N	O	P	Q	R	S	T	U	(# above U) *	S Nail	M Nail
4200	4266	4332	4398	4464	4530	4596	4662	4728	4794	4860	4926	4992	5058	5124	5190	5256	66 (Riser) + 5256 (U)	N/A	N/A
Leather 1 N/A		Leather 2 N/A		Leather 3 N/A		Leather 4 N/A		Leather 5 N/A		Leather 6 N/A		Leather 8 N/A		COL N/A		S Nail N/A		M Nail N/A	

Fabric SKU: **2102-54**

Leather SKU: **N/A**

Standard Pillows: (3) 20 x 20 **Finish Req:** Y

Standard Cushions: Blendown **Standard Finish:**

COM: 23.5 yards **COL:** N/A

Avalon Left Arm Corner Sofa

Width: 108.25 **Depth:** 41 **Height:** 35

AH: 31 **SH:** 20 **SD:** 22 **IW:** 83.75

Weight: 165 lbs **Cube:** 89.89

D	E	F	G	H	J	K COM	L	M	N	O	P	Q	R	S	T	U	(# above U) *	S Nail	M Nail
4200	4266	4332	4398	4464	4530	4596	4662	4728	4794	4860	4926	4992	5058	5124	5190	5256	66 (Riser) + 5256 (U)	195	N/A
Leather 1 N/A		Leather 2 N/A		Leather 3 N/A		Leather 4 N/A		Leather 5 N/A		Leather 6 N/A		Leather 8 N/A		COL N/A		S Nail N/A		M Nail N/A	

Fabric SKU: **2102-71**

Leather SKU: **N/A**

Standard Pillows: (1) 20 x 20 **Finish Req:** Y

Standard Cushions: Blendown **Standard Finish:**

COM: 15.75 yards **COL:** N/A

Avalon Left Arm Loveseat

Width: 69 **Depth:** 41 **Height:** 35

AH: 31 **SH:** 20 **SD:** 22 **IW:** 64.25

Weight: 150 lbs **Cube:** 57.3

D	E	F	G	H	J	K COM	L	M	N	O	P	Q	R	S	T	U	(# above U) *	S Nail	M Nail
3750	3792	3834	3876	3918	3960	4002	4044	4086	4128	4170	4212	4254	4296	4338	4380	4422	42 (Riser) + 4422 (U)	135	N/A
Leather 1 N/A		Leather 2 N/A		Leather 3 N/A		Leather 4 N/A		Leather 5 N/A		Leather 6 N/A		Leather 8 N/A		COL N/A		S Nail N/A		M Nail N/A	

Fabric SKU: **2102-72**

Leather SKU: **N/A**

Standard Pillows: (1) 20 x 20 **Finish Req:** Y

Standard Cushions: Blendown **Standard Finish:**

COM: 15.75 yards **COL:** N/A

Avalon Right Arm Loveseat

Width: 69 **Depth:** 41 **Height:** 35

AH: 31 **SH:** 20 **SD:** 22 **IW:** 64.25

Weight: 150 lbs **Cube:** 57.3

D	E	F	G	H	J	K COM	L	M	N	O	P	Q	R	S	T	U	(# above U) *	S Nail	M Nail
3750	3792	3834	3876	3918	3960	4002	4044	4086	4128	4170	4212	4254	4296	4338	4380	4422	42 (Riser) + 4422 (U)	135	N/A
Leather 1 N/A		Leather 2 N/A		Leather 3 N/A		Leather 4 N/A		Leather 5 N/A		Leather 6 N/A		Leather 8 N/A		COL N/A		S Nail N/A		M Nail N/A	

Fabric SKU: **2102-84**

Leather SKU: **N/A**

Standard Pillows: (2) 20 x 20 **Finish Req:** Y

Standard Cushions: Blendown **Standard Finish:**

COM: 18 yards **COL:** N/A

Avalon 84" Sofa

Two Seats over Two Backs

Width: 84 **Depth:** 41 **Height:** 35

AH: 31 **SH:** 20 **SD:** 22 **IW:** 62

Weight: 150 lbs **Cube:** 69.75

D	E	F	G	H	J	K COM	L	M	N	O	P	Q	R	S	T	U	(# above U) *	S Nail	M Nail
3900	3945	3990	4035	4080	4125	4170	4215	4260	4305	4350	4395	4440	4485	4530	4575	4620	45 (Riser) + 4620 (U)	165	N/A
Leather 1 N/A		Leather 2 N/A		Leather 3 N/A		Leather 4 N/A		Leather 5 N/A		Leather 6 N/A		Leather 8 N/A		COL N/A		S Nail N/A		M Nail N/A	

Fabric SKU: **2102-94**

Leather SKU: **N/A**

Standard Pillows: (2) 20 x 20 **Finish Req:** Y

Standard Cushions: Blendown **Standard Finish:**

COM: 18 yards **COL:** N/A

Avalon 94" Sofa

Two Seats over Two Backs

Width: 94 **Depth:** 41 **Height:** 35

AH: 31 **SH:** 20 **SD:** 22 **IW:** 62

Weight: 170 lbs **Cube:** 78.06

D	E	F	G	H	J	K COM	L	M	N	O	P	Q	R	S	T	U	(# above U) *	S Nail	M Nail
4050	4098	4146	4194	4242	4290	4338	4386	4434	4482	4530	4578	4626	4674	4722	4770	4818	48 (Riser) + 4818 (U)	165	N/A
Leather 1 N/A		Leather 2 N/A		Leather 3 N/A		Leather 4 N/A		Leather 5 N/A		Leather 6 N/A		Leather 8 N/A		COL N/A		S Nail N/A		M Nail N/A	

Upholstery

**Pillows are not available on leather SKUs*

Fabric SKU: 2102-X4

Leather SKU: N/A

Standard Pillows: (2) 20 x 20 Finish Req: Y

Standard Cushions: Blendown Standard Finish:

COM: 18 yards COL: N/A

Avalon 104" Sofa

Two Seats over Two Backs

Width: 104 Depth: 41 Height: 35

AH: 31 SH: 20 SD: 22 IW: 62

Weight: 180 lbs Cube: 86.36

D	E	F	G	H	J	K COM	L	M	N	O	P	Q	R	S	T	U	(# above U) *	S Nail	M Nail
4200	4251	4302	4353	4404	4455	4506	4557	4608	4659	4710	4761	4812	4863	4914	4965	5016	51 (Riser) + 5016 (U)	195	N/A
Leather 1 N/A		Leather 2 N/A		Leather 3 N/A		Leather 4 N/A		Leather 5 N/A		Leather 6 N/A		Leather 8 N/A		COL N/A		S Nail N/A		M Nail N/A	

Fabric SKU: 2103-01

Leather SKU: L-2103-01

Standard Pillows: N/A Finish Req: N

Standard Cushions: High Resiliency 30 Standard Finish:

COM: 6 yards COL: 102 square feet

Our Coco Lounge and Swivel Chair series are standard with a prefinished base in black. No finish options are available.

Coco Grande Lounge Chair

Width: 31 Depth: 35.5 Height: 34.5

AH: 24.75 SH: 18.25 SD: 19 IW: 23

Weight: 71 lbs Cube: 21.97

D	E	F	G	H	J	K COM	L	M	N	O	P	Q	R	S	T	U	(# above U) *	S Nail	M Nail
2325	2343	2361	2379	2397	2415	2433	2451	2469	2487	2505	2523	2541	2559	2577	2595	2613	18 (Riser) + 2613 (U)	N/A	N/A
Leather 1 3450		Leather 2 3615		Leather 3 3780		Leather 4 3945		Leather 5 4110		Leather 6 4275		Leather 8 5685		COL 2469		S Nail N/A		M Nail N/A	

Fabric SKU: 2103-31

Leather SKU: L-2103-31

Standard Pillows: N/A Finish Req: N

Standard Cushions: High Resiliency 30 Standard Finish:

COM: 6 yards COL: 102 square feet

Our Coco Lounge and Swivel Chair series are standard with a prefinished base in black. No finish options are available.

Coco Grande Swivel Chair

Width: 31 Depth: 35.5 Height: 34.5

AH: 24.75 SH: 18.25 SD: 19 IW: 23

Weight: 71 lbs Cube: 21.97

D	E	F	G	H	J	K COM	L	M	N	O	P	Q	R	S	T	U	(# above U) *	S Nail	M Nail
2400	2418	2436	2454	2472	2490	2508	2526	2544	2562	2580	2598	2616	2634	2652	2670	2688	18 (Riser) + 2688 (U)	N/A	N/A
Leather 1 3525		Leather 2 3690		Leather 3 3855		Leather 4 4020		Leather 5 4185		Leather 6 4350		Leather 8 5760		COL 2544		S Nail N/A		M Nail N/A	

Fabric SKU: 2103-55

Leather SKU: L-2103-55

Standard Pillows: (2) 20 x 20 Finish Req: Y

Standard Cushions: High Resiliency 30 Standard Finish:

COM: 10.5 yards COL: 192 square feet

Coco Tete-A-Tete Conversation Sofa

Width: 76.5 Depth: 34.25 Height: 29.5

AH: 23.75 SH: 18.5 SD: 25 IW: 44

Weight: 120 lbs Cube: 44.73

D	E	F	G	H	J	K COM	L	M	N	O	P	Q	R	S	T	U	(# above U) *	S Nail	M Nail
4185	4218	4251	4284	4317	4350	4383	4416	4449	4482	4515	4548	4581	4614	4647	4680	4713	33 (Riser) + 4713 (U)	N/A	N/A
Leather 1 5685		Leather 2 5985		Leather 3 6285		Leather 4 6585		Leather 5 6885		Leather 6 7185		Leather 8 9825		COL 4449		S Nail N/A		M Nail N/A	

Fabric SKU: 2200-01

Leather SKU: N/A

Standard Pillows: (1) 12x18 Kidney Pillow. Inside seat depth without kidney pillow 24" Finish Req: Y

Standard Cushions: Classic Plush Standard Finish:

COM: 6.25 yards COL: N/A

Audrey Lounge Chair

Width: 29.5 Depth: 37.5 Height: 32.5

AH: 21.5 SH: 18.5 SD: 19.5 IW: 21.5

Weight: 51 lbs Cube: 20.8

D	E	F	G	H	J	K COM	L	M	N	O	P	Q	R	S	T	U	(# above U) *	S Nail	M Nail
2325	2343	2361	2379	2397	2415	2433	2451	2469	2487	2505	2523	2541	2559	2577	2595	2613	18 (Riser) + 2613 (U)	75	N/A
Leather 1 N/A		Leather 2 N/A		Leather 3 N/A		Leather 4 N/A		Leather 5 N/A		Leather 6 N/A		Leather 8 N/A		COL N/A		S Nail N/A		M Nail N/A	

Fabric SKU: 2200-31

Leather SKU: N/A

Standard Pillows: (1) 12x18 Kidney Pillow. Inside seat depth without kidney pillow 24" Finish Req: N

Standard Cushions: Classic Plush Standard Finish: Contemporary

COM: 6.5 yards COL: N/A

Audrey Swivel Chair

Width: 29.5 Depth: 37.5 Height: 32.5

AH: 21.5 SH: 18.5 SD: 19.5 IW: 21.5

Weight: 51 lbs Cube: 36.49

D	E	F	G	H	J	K COM	L	M	N	O	P	Q	R	S	T	U	(# above U) *	S Nail	M Nail
2400	2418	2436	2454	2472	2490	2508	2526	2544	2562	2580	2598	2616	2634	2652	2670	2688	18 (Riser) + 2688 (U)	75	N/A
Leather 1 N/A		Leather 2 N/A		Leather 3 N/A		Leather 4 N/A		Leather 5 N/A		Leather 6 N/A		Leather 8 N/A		COL N/A		S Nail N/A		M Nail N/A	

Upholstery

**Pillows are not available on leather SKUs*

Fabric SKU: **2200-50**

Leather SKU: **N/A**

Standard Pillows: (2) 22 x 22, (1) Kidney 18 x 46 **Finish Req:** Y

Standard Cushions: Classic Plush **Standard Finish:**

COM: 14.75 yards **COL:** N/A

Audrey Sofa

Tight Back with Two Seats

Width: 85 **Depth:** 37.5 **Height:** 32.5

AH: 21 **SH:** 20 **SD:** 21 **IW:** 78

Weight: 114 lbs **Cube:** 59.95

D	E	F	G	H	J	K COM	L	M	N	O	P	Q	R	S	T	U	(# above U) *	S Nail	M Nail
4125	4164	4203	4242	4281	4320	4359	4398	4437	4476	4515	4554	4593	4632	4671	4710	4749	39 (Riser) + 4749 (U)	135	N/A
Leather 1 N/A		Leather 2 N/A		Leather 3 N/A		Leather 4 N/A		Leather 5 N/A		Leather 6 N/A		Leather 8 N/A		COL N/A		S Nail N/A		M Nail N/A	

Fabric SKU: **2210-50**

Leather SKU: **N/A**

Standard Pillows: (2) 22 x 22, (1) Kidney 18 x 46 **Finish Req:** Y

Standard Cushions: Classic Plush **Standard Finish:**

COM: 13.75 yards **COL:** N/A

Audrey Sofa

Tight Back with One Seat

Width: 85 **Depth:** 37.5 **Height:** 32.5

AH: 21 **SH:** 20 **SD:** 21 **IW:** 78

Weight: 114 lbs **Cube:** 59.95

D	E	F	G	H	J	K COM	L	M	N	O	P	Q	R	S	T	U	(# above U) *	S Nail	M Nail
4125	4164	4203	4242	4281	4320	4359	4398	4437	4476	4515	4554	4593	4632	4671	4710	4749	39 (Riser) + 4749 (U)	135	N/A
Leather 1 N/A		Leather 2 N/A		Leather 3 N/A		Leather 4 N/A		Leather 5 N/A		Leather 6 N/A		Leather 8 N/A		COL N/A		S Nail N/A		M Nail N/A	

Fabric SKU: **2600-21**

Leather SKU: **N/A**

Standard Pillows: (3) 26 x 26, (2) 24 x 24, (2) 20 x 20, (1) 24x34 Kidney **Finish Req:** Y

Standard Cushions: High Resiliency 30 **Standard Finish:**

COM: 16 yards **COL:** N/A

Torrance Chofa

Width: 62.5 **Depth:** 69 **Height:** 41

AH: 22.5 **SH:** 19 **SD:** 40 **IW:** 55

Weight: 161 lbs **Cube:** 102.32

D	E	F	G	H	J	K COM	L	M	N	O	P	Q	R	S	T	U	(# above U) *	S Nail	M Nail
4485	4530	4575	4620	4665	4710	4755	4800	4845	4890	4935	4980	5025	5070	5115	5160	5205	45 (Riser) + 5205 (U)	N/A	N/A
Leather 1 N/A		Leather 2 N/A		Leather 3 N/A		Leather 4 N/A		Leather 5 N/A		Leather 6 N/A		Leather 8 N/A		COL N/A		S Nail N/A		M Nail N/A	

Fabric SKU: **2600-31**

Leather SKU: **N/A**

Standard Pillows: N/A **Finish Req:** N

Standard Cushions: High Resiliency 30 **Standard Finish:**

COM: 5.25 yards **COL:** N/A

Torrance Swivel Chair

Width: 32.5 **Depth:** 34 **Height:** 38

AH: 24 **SH:** 20 **SD:** 19 **IW:** 25.5

Weight: 60 lbs **Cube:** 24.29

D	E	F	G	H	J	K COM	L	M	N	O	P	Q	R	S	T	U	(# above U) *	S Nail	M Nail
1950	1965	1980	1995	2010	2025	2040	2055	2070	2085	2100	2115	2130	2145	2160	2175	2190	15 (Riser) + 2190 (U)	N/A	N/A
Leather 1 N/A		Leather 2 N/A		Leather 3 N/A		Leather 4 N/A		Leather 5 N/A		Leather 6 N/A		Leather 8 N/A		COL N/A		S Nail N/A		M Nail N/A	

Fabric SKU: **2601-25**

Leather SKU: **N/A**

Standard Pillows: N/A **Finish Req:** Y

Standard Cushions: Blendown **Standard Finish:**

COM: 10.75 yards **COL:** N/A

Carlyle Chaise Lounge

Width: 28.5 **Depth:** 64 **Height:** 40

AH: 20 **SH:** 21 **SD:** 48 **IW:** 23

Weight: 105 lbs **Cube:** 59.39

D	E	F	G	H	J	K COM	L	M	N	O	P	Q	R	S	T	U	(# above U) *	S Nail	M Nail
3075	3105	3135	3165	3195	3225	3255	3285	3315	3345	3375	3405	3435	3465	3495	3525	3555	30 (Riser) + 3555 (U)	90	105
Leather 1 N/A		Leather 2 N/A		Leather 3 N/A		Leather 4 N/A		Leather 5 N/A		Leather 6 N/A		Leather 8 N/A		COL N/A		S Nail N/A		M Nail N/A	

Fabric SKU: **2674-25**

Leather SKU: **N/A**

Standard Pillows: (2) 22 x 7 Bolster **Finish Req:** Y

Standard Cushions: Ultra Plush **Standard Finish:**

COM: 9.75 yards **COL:** N/A

Countess Chaise Lounge

Width: 76.5 **Depth:** 27.5 **Height:** 30

AH: 30 **SH:** 22 **SD:** 28 **IW:** 45.5

Weight: 96 lbs **Cube:** 68.15

D	E	F	G	H	J	K COM	L	M	N	O	P	Q	R	S	T	U	(# above U) *	S Nail	M Nail
3285	3312	3339	3366	3393	3420	3447	3474	3501	3528	3555	3582	3609	3636	3663	3690	3717	27 (Riser) + 3717 (U)	75	90
Leather 1 N/A		Leather 2 N/A		Leather 3 N/A		Leather 4 N/A		Leather 5 N/A		Leather 6 N/A		Leather 8 N/A		COL N/A		S Nail N/A		M Nail N/A	

Upholstery

**Pillows are not available on leather SKUs*

Fabric SKU: 2701-50

Leather SKU: N/A

Standard Pillows: (2) 20 x 20, (1) 12" Sphere **Finish Req:** Y

Standard Cushions: Classic Plush **Standard Finish:**

COM: 16.5 yards **COL:** N/A

Dreamy Sofa

Width: 94 **Depth:** 39 **Height:** 33.5

AH: 26.5 **SH:** 20.5 **SD:** 23 **IW:** 73

Weight: 132 lbs **Cube:** 92.4

D	E	F	G	H	J	K COM	L	M	N	O	P	Q	R	S	T	U	(# above U) *	S Nail	M Nail
4185	4233	4281	4329	4377	4425	4473	4521	4569	4617	4665	4713	4761	4809	4857	4905	4953	48 (Riser) + 4953 (U)	N/A	N/A
Leather 1 N/A		Leather 2 N/A		Leather 3 N/A		Leather 4 N/A		Leather 5 N/A		Leather 6 N/A		Leather 8 N/A		COL N/A		S Nail N/A		M Nail N/A	

Fabric SKU: 2702-50

Leather SKU: L-2702-50

Standard Pillows: (2) 20 x 20 **Finish Req:** Y

Standard Cushions: Ultra Plush **Standard Finish:**

COM: 19 yards **COL:** 270 square feet

Vincent Sofa

Width: 88.25 **Depth:** 40 **Height:** 41.5

AH: 23 **SH:** 21.5 **SD:** 21 **IW:** 80

Weight: 134 lbs **Cube:** 92.4

D	E	F	G	H	J	K COM	L	M	N	O	P	Q	R	S	T	U	(# above U) *	S Nail	M Nail
4575	4629	4683	4737	4791	4845	4899	4953	5007	5061	5115	5169	5223	5277	5331	5385	5439	54 (Riser) + 5439 (U)	75	N/A
Leather 1 7680		Leather 2 8085		Leather 3 8490		Leather 4 8895		Leather 5 9300		Leather 6 9705		Leather 8 13425		COL 5007		S Nail 75		M Nail N/A	

Fabric SKU: 2703-02

Leather SKU: N/A

Standard Pillows: (1) 20 x 20 **Finish Req:** N

Standard Cushions: Classic Plush **Standard Finish:**

COM: 10 yards **COL:** N/A

Standard with Sectional Attachment Clips.

Noho Right Arm Chair

Width: 38.5 **Depth:** 39 **Height:** 37

AH: 23.5 **SH:** 18.5 **SD:** 24 **IW:** 33

Weight: 70 lbs **Cube:** 32.15

D	E	F	G	H	J	K COM	L	M	N	O	P	Q	R	S	T	U	(# above U) *	S Nail	M Nail
2220	2250	2280	2310	2340	2370	2400	2430	2460	2490	2520	2550	2580	2610	2640	2670	2700	30 (Riser) + 2700 (U)	45	60
Leather 1 N/A		Leather 2 N/A		Leather 3 N/A		Leather 4 N/A		Leather 5 N/A		Leather 6 N/A		Leather 8 N/A		COL N/A		S Nail N/A		M Nail N/A	

Fabric SKU: 2703-03

Leather SKU: N/A

Standard Pillows: (1) 20 x 20 **Finish Req:** N

Standard Cushions: Classic Plush **Standard Finish:**

COM: 10 yards **COL:** N/A

Standard with Sectional Attachment Clips.

Noho Left Arm Chair

Width: 38.5 **Depth:** 39 **Height:** 37

AH: 23.5 **SH:** 18.5 **SD:** 24 **IW:** 33

Weight: 70 lbs **Cube:** 32.15

D	E	F	G	H	J	K COM	L	M	N	O	P	Q	R	S	T	U	(# above U) *	S Nail	M Nail
2220	2250	2280	2310	2340	2370	2400	2430	2460	2490	2520	2550	2580	2610	2640	2670	2700	30 (Riser) + 2700 (U)	45	60
Leather 1 N/A		Leather 2 N/A		Leather 3 N/A		Leather 4 N/A		Leather 5 N/A		Leather 6 N/A		Leather 8 N/A		COL N/A		S Nail N/A		M Nail N/A	

Fabric SKU: 2703-26

Leather SKU: N/A

Standard Pillows: (1) 20 x 20 **Finish Req:** N

Standard Cushions: Classic Plush **Standard Finish:**

COM: 12.25 yards **COL:** N/A

Standard with Sectional Attachment Clips.

Noho Right Arm Chaise

Width: 38.5 **Depth:** 66 **Height:** 37

AH: 23.5 **SH:** 18.5 **SD:** 51 **IW:** 33

Weight: 90 lbs **Cube:** 54.4

D	E	F	G	H	J	K COM	L	M	N	O	P	Q	R	S	T	U	(# above U) *	S Nail	M Nail
2985	3021	3057	3093	3129	3165	3201	3237	3273	3309	3345	3381	3417	3453	3489	3525	3561	36 (Riser) + 3561 (U)	60	75
Leather 1 N/A		Leather 2 N/A		Leather 3 N/A		Leather 4 N/A		Leather 5 N/A		Leather 6 N/A		Leather 8 N/A		COL N/A		S Nail N/A		M Nail N/A	

Fabric SKU: 2703-27

Leather SKU: N/A

Standard Pillows: (1) 20 x 20 **Finish Req:** N

Standard Cushions: Classic Plush **Standard Finish:**

COM: 12.25 yards **COL:** N/A

Standard with Sectional Attachment Clips.

Noho Left Arm Chaise

Width: 38.5 **Depth:** 66 **Height:** 37

AH: 23.5 **SH:** 18.5 **SD:** 51 **IW:** 33

Weight: 90 lbs **Cube:** 54.4

D	E	F	G	H	J	K COM	L	M	N	O	P	Q	R	S	T	U	(# above U) *	S Nail	M Nail
2985	3021	3057	3093	3129	3165	3201	3237	3273	3309	3345	3381	3417	3453	3489	3525	3561	36 (Riser) + 3561 (U)	60	75
Leather 1 N/A		Leather 2 N/A		Leather 3 N/A		Leather 4 N/A		Leather 5 N/A		Leather 6 N/A		Leather 8 N/A		COL N/A		S Nail N/A		M Nail N/A	

Upholstery

**Pillows are not available on leather SKUs*

Fabric SKU: 2703-29

Leather SKU: N/A

Standard Pillows: (2) 20 x 20 Finish Req: N

Standard Cushions: Classic Plush Standard Finish:

COM: 12.5 yards COL: N/A

Standard with Sectional Attachment Clips.

Noho Corner Chair

Width: 38.5 Depth: 39 Height: 37

AH: 0 SH: 18.5 SD: 24 IW: 24

Weight: 74 lbs Cube: 32.15

D	E	F	G	H	J	K COM	L	M	N	O	P	Q	R	S	T	U	(# above U) *	S Nail	M Nail
2370	2406	2442	2478	2514	2550	2586	2622	2658	2694	2730	2766	2802	2838	2874	2910	2946	36 (Riser) + 2946 (U)	45	60
Leather 1 N/A		Leather 2 N/A		Leather 3 N/A		Leather 4 N/A		Leather 5 N/A		Leather 6 N/A		Leather 8 N/A		COL N/A		S Nail N/A		M Nail N/A	

Fabric SKU: 2703-67

Leather SKU: N/A

Standard Pillows: N/A Finish Req: N

Standard Cushions: Classic Plush Standard Finish:

COM: 5.25 yards COL: N/A

Standard with Sectional Attachment Clips.

Noho Bumper Ottoman

Width: 33 Depth: 39 Height: 18.5

AH: 0 SH: 18.5 SD: 39 IW: 33

Weight: 50 lbs Cube: 13.77

D	E	F	G	H	J	K COM	L	M	N	O	P	Q	R	S	T	U	(# above U) *	S Nail	M Nail
1425	1440	1455	1470	1485	1500	1515	1530	1545	1560	1575	1590	1605	1620	1635	1650	1665	15 (Riser) + 1665 (U)	60	75
Leather 1 N/A		Leather 2 N/A		Leather 3 N/A		Leather 4 N/A		Leather 5 N/A		Leather 6 N/A		Leather 8 N/A		COL N/A		S Nail N/A		M Nail N/A	

Fabric SKU: 2703-78

Leather SKU: N/A

Standard Pillows: N/A Finish Req: N

Standard Cushions: Classic Plush Standard Finish:

COM: 8.25 yards COL: N/A

Standard with Sectional Attachment Clips.

Noho Armless Sectional Chair

Width: 33 Depth: 39 Height: 37

AH: 0 SH: 18.5 SD: 24 IW: 33

Weight: 54 lbs Cube: 27.55

D	E	F	G	H	J	K COM	L	M	N	O	P	Q	R	S	T	U	(# above U) *	S Nail	M Nail
1785	1803	1821	1839	1857	1875	1893	1911	1929	1947	1965	1983	2001	2019	2037	2055	2073	18 (Riser) + 2073 (U)	45	60
Leather 1 N/A		Leather 2 N/A		Leather 3 N/A		Leather 4 N/A		Leather 5 N/A		Leather 6 N/A		Leather 8 N/A		COL N/A		S Nail N/A		M Nail N/A	

Fabric SKU: 2704-50

Leather SKU: L-2704-50

Standard Pillows: (2) 20 x 20 Finish Req: Y

Standard Cushions: Classic Plush Standard Finish:

COM: 13.75 yards COL: 220 square feet

Bronson Sofa

Tufted Back over One Seat

Width: 89.75 Depth: 38.5 Height: 34

AH: 23 SH: 18.75 SD: 22 IW: 75

Weight: 130 lbs Cube: 67.98

D	E	F	G	H	J	K COM	L	M	N	O	P	Q	R	S	T	U	(# above U) *	S Nail	M Nail
4785	4824	4863	4902	4941	4980	5019	5058	5097	5136	5175	5214	5253	5292	5331	5370	5409	39 (Riser) + 5409 (U)	90	105
Leather 1 7185		Leather 2 7515		Leather 3 7845		Leather 4 8175		Leather 5 8505		Leather 6 8835		Leather 8 11865		COL 5097		S Nail 90		M Nail 105	

Fabric SKU: 2706-50

Leather SKU: L-2706-50

Standard Pillows: (2) 20 x 20 Finish Req: Y

Standard Cushions: Ultra Plush Standard Finish:

COM: 15.75 yards COL: 237 square feet

McCoy 2 Back over 1 Bench Cushion Sofa

Width: 85 Depth: 40 Height: 38.5

AH: 26.5 SH: 19 SD: 21 IW: 75

Weight: 146 lbs Cube: 75.75

D	E	F	G	H	J	K COM	L	M	N	O	P	Q	R	S	T	U	(# above U) *	S Nail	M Nail
4800	4848	4896	4944	4992	5040	5088	5136	5184	5232	5280	5328	5376	5424	5472	5520	5568	48 (Riser) + 5568 (U)	75	90
Leather 1 7620		Leather 2 7980		Leather 3 8340		Leather 4 8700		Leather 5 9060		Leather 6 9420		Leather 8 12690		COL 5184		S Nail 75		M Nail 90	

Fabric SKU: 2707-01

Leather SKU: L-2707-01

Standard Pillows: N/A Finish Req: Y

Standard Cushions: Ultra Plush Standard Finish:

COM: 7.25 yards COL: 119 square feet

McCoy Lounge Chair

Width: 31.5 Depth: 40 Height: 38.5

AH: 26.5 SH: 19 SD: 21 IW: 21.5

Weight: 67 lbs Cube: 36.49

D	E	F	G	H	J	K COM	L	M	N	O	P	Q	R	S	T	U	(# above U) *	S Nail	M Nail
2775	2796	2817	2838	2859	2880	2901	2922	2943	2964	2985	3006	3027	3048	3069	3090	3111	21 (Riser) + 3111 (U)	45	60
Leather 1 4290		Leather 2 4470		Leather 3 4650		Leather 4 4830		Leather 5 5010		Leather 6 5190		Leather 8 6825		COL 2943		S Nail 45		M Nail 60	

Upholstery

**Pillows are not available on leather SKUs*

Fabric SKU: 2707-20

Leather SKU: L-2707-20

Standard Pillows: N/A Finish Req: Y

Standard Cushions: High Resiliency 30 Standard Finish:

COM: 2.75 yards COL: 57 square feet

McCoy Ottoman

Width: 26 Depth: 21 Height: 17

AH: 0 SH: 0 SD: 0 IW: 0

Weight: 19 lbs Cube: 5.37

D	E	F	G	H	J	K COM	L	M	N	O	P	Q	R	S	T	U	(# above U) *	S Nail	M Nail
1320	1329	1338	1347	1356	1365	1374	1383	1392	1401	1410	1419	1428	1437	1446	1455	1464	9 (Riser) + 1464 (U)	30	45
Leather 1 2070		Leather 2 2160		Leather 3 2250		Leather 4 2340		Leather 5 2430		Leather 6 2520		Leather 8 3315		COL 1392		S Nail 30		M Nail 45	

Fabric SKU: 2707-50

Leather SKU: L-2707-50

Standard Pillows: (2) 20 x 20 Finish Req: Y

Standard Cushions: Ultra Plush Standard Finish:

COM: 16 yards COL: 237 square feet

McCoy 3 Back over 3 Cushion Sofa

Width: 85 Depth: 40 Height: 38.5

AH: 26.5 SH: 19 SD: 21 IW: 75

Weight: 146 lbs Cube: 79.34

D	E	F	G	H	J	K COM	L	M	N	O	P	Q	R	S	T	U	(# above U) *	S Nail	M Nail
4800	4848	4896	4944	4992	5040	5088	5136	5184	5232	5280	5328	5376	5424	5472	5520	5568	48 (Riser) + 5568 (U)	75	90
Leather 1 7620		Leather 2 7980		Leather 3 8340		Leather 4 8700		Leather 5 9060		Leather 6 9420		Leather 8 12690		COL 5184		S Nail 75		M Nail 90	

Fabric SKU: 2708-50

Leather SKU: L-2708-50

Standard Pillows: (2) 20 x 20 Finish Req: Y

Standard Cushions: Ultra Plush Standard Finish:

COM: 17.75 yards COL: 231 square feet

McCoy 2 Back over 2 Cushion Sofa

Width: 85 Depth: 40 Height: 38.5

AH: 26.5 SH: 19 SD: 21 IW: 75

Weight: 146 lbs Cube: 79.34

D	E	F	G	H	J	K COM	L	M	N	O	P	Q	R	S	T	U	(# above U) *	S Nail	M Nail
4725	4773	4821	4869	4917	4965	5013	5061	5109	5157	5205	5253	5301	5349	5397	5445	5493	48 (Riser) + 5493 (U)	75	90
Leather 1 7620		Leather 2 7965		Leather 3 8310		Leather 4 8655		Leather 5 9000		Leather 6 9345		Leather 8 12525		COL 5109		S Nail 75		M Nail 90	

Fabric SKU: 2712-50

Leather SKU: L-2712-50

Standard Pillows: (2) 20 x 20 Finish Req: Y

Standard Cushions: Ultra Plush Standard Finish:

COM: 16.25 yards COL: 254 square feet

Vincent Sofa

Width: 88.25 Depth: 40 Height: 41.5

AH: 23 SH: 21.5 SD: 21 IW: 80

Weight: 134 lbs Cube: 92.4

D	E	F	G	H	J	K COM	L	M	N	O	P	Q	R	S	T	U	(# above U) *	S Nail	M Nail
4350	4395	4440	4485	4530	4575	4620	4665	4710	4755	4800	4845	4890	4935	4980	5025	5070	45 (Riser) + 5070 (U)	75	N/A
Leather 1 7650		Leather 2 8040		Leather 3 8430		Leather 4 8820		Leather 5 9210		Leather 6 9600		Leather 8 13095		COL 4710		S Nail 75		M Nail N/A	

Fabric SKU: 2717-51

Leather SKU: N/A

Standard Pillows: (2) 20 x 20 (2) 24 x 24 Finish Req: N

Standard Cushions: High Resiliency 30 Standard Finish: Traditional

COM: 12 yards COL: N/A
Coordinates with 1631-20 and 1632-20.

Madeline Right Arm Facing Sofa

Width: 90 Depth: 38 Height: 32.5

AH: 24 SH: 18 SD: 27.5 IW: 76

Weight: 118 lbs Cube: 92.4

D	E	F	G	H	J	K COM	L	M	N	O	P	Q	R	S	T	U	(# above U) *	S Nail	M Nail
3720	3756	3792	3828	3864	3900	3936	3972	4008	4044	4080	4116	4152	4188	4224	4260	4296	36 (Riser) + 4296 (U)	105	120
Leather 1 N/A		Leather 2 N/A		Leather 3 N/A		Leather 4 N/A		Leather 5 N/A		Leather 6 N/A		Leather 8 N/A		COL N/A		S Nail N/A		M Nail N/A	

Fabric SKU: 2717-52

Leather SKU: N/A

Standard Pillows: (2) 20 x 20 (2) 24 x 24 Finish Req: N

Standard Cushions: High Resiliency 30 Standard Finish: Traditional

COM: 12 yards COL: N/A
Coordinates with 1631-20 and 1632-20.

Madeline Left Arm Facing Sofa

Width: 90 Depth: 38 Height: 32.5

AH: 24 SH: 18 SD: 27.5 IW: 76

Weight: 118 lbs Cube: 79.34

D	E	F	G	H	J	K COM	L	M	N	O	P	Q	R	S	T	U	(# above U) *	S Nail	M Nail
3720	3756	3792	3828	3864	3900	3936	3972	4008	4044	4080	4116	4152	4188	4224	4260	4296	36 (Riser) + 4296 (U)	105	120
Leather 1 N/A		Leather 2 N/A		Leather 3 N/A		Leather 4 N/A		Leather 5 N/A		Leather 6 N/A		Leather 8 N/A		COL N/A		S Nail N/A		M Nail N/A	

Upholstery

**Pillows are not available on leather SKUs*

Fabric SKU: 2718-50

Leather SKU: N/A

Standard Pillows: (2) 22 x 22 Finish Req: N

Standard Cushions: Classic Plush Standard Finish: Traditional

COM: 18.5 yards COL: N/A

DeMille Sofa

Two Backs over One Seat

Width: 93 Depth: 39 Height: 38

AH: 25 SH: 20 SD: 20.5 IW: 76

Weight: 158 lbs Cube: 79.76

D	E	F	G	H	J	K COM	L	M	N	O	P	Q	R	S	T	U	(# above U) *	S Nail	M Nail
4425	4476	4527	4578	4629	4680	4731	4782	4833	4884	4935	4986	5037	5088	5139	5190	5241	51 (Riser) + 5241 (U)	N/A	N/A
Leather 1 N/A		Leather 2 N/A		Leather 3 N/A		Leather 4 N/A		Leather 5 N/A		Leather 6 N/A		Leather 8 N/A		COL N/A		S Nail N/A		M Nail N/A	

Fabric SKU: 2721-50

Leather SKU: N/A

Standard Pillows: (2) 20 x 20 Finish Req: N

Standard Cushions: Ultra Plush Standard Finish: Traditional

COM: 19.25 yards COL: N/A

Cassandra Sofa

Width: 91.5 Depth: 41.5 Height: 36

AH: 24.75 SH: 19.5 SD: 22 IW: 78.5

Weight: 140 lbs Cube: 79.34

D	E	F	G	H	J	K COM	L	M	N	O	P	Q	R	S	T	U	(# above U) *	S Nail	M Nail
4350	4404	4458	4512	4566	4620	4674	4728	4782	4836	4890	4944	4998	5052	5106	5160	5214	54 (Riser) + 5214 (U)	N/A	N/A
Leather 1 N/A		Leather 2 N/A		Leather 3 N/A		Leather 4 N/A		Leather 5 N/A		Leather 6 N/A		Leather 8 N/A		COL N/A		S Nail N/A		M Nail N/A	

Fabric SKU: 2722-20

Leather SKU: L-2722-20

Standard Pillows: N/A Finish Req: Y

Standard Cushions: High Resiliency 20 Standard Finish:

COM: 3.25 yards COL: 45 square feet

Olivia Ottoman

Width: 28 Depth: 21 Height: 16

AH: 0 SH: 16 SD: 0 IW: 0

Weight: 26 lbs Cube: 10.77

D	E	F	G	H	J	K COM	L	M	N	O	P	Q	R	S	T	U	(# above U) *	S Nail	M Nail
1110	1122	1134	1146	1158	1170	1182	1194	1206	1218	1230	1242	1254	1266	1278	1290	1302	12 (Riser) + 1302 (U)	30	45
Leather 1 2070		Leather 2 2145		Leather 3 2220		Leather 4 2295		Leather 5 2370		Leather 6 2445		Leather 8 3075		COL 1206		S Nail 30		M Nail 45	

Fabric SKU: 2722-31

Leather SKU: L-2722-31

Standard Pillows: N/A Finish Req: N

Standard Cushions: Ultra Plush Standard Finish:

COM: 10.25 yards COL: 119 square feet

Olivia Swivel Chair

Width: 34.5 Depth: 38.5 Height: 35

AH: 24 SH: 17 SD: 22 IW: 24.5

Weight: 60 lbs Cube: 36.49

D	E	F	G	H	J	K COM	L	M	N	O	P	Q	R	S	T	U	(# above U) *	S Nail	M Nail
2325	2349	2373	2397	2421	2445	2469	2493	2517	2541	2565	2589	2613	2637	2661	2685	2709	24 (Riser) + 2709 (U)	90	105
Leather 1 3810		Leather 2 3990		Leather 3 4170		Leather 4 4350		Leather 5 4530		Leather 6 4710		Leather 8 6345		COL 2517		S Nail 90		M Nail 105	

Fabric SKU: 2722-32

Leather SKU: L-2722-32

Standard Pillows: N/A Finish Req: N

Standard Cushions: Ultra Plush Standard Finish:

COM: 8.75 yards COL: 124 square feet

Olivia Swivel Glider

Width: 34.5 Depth: 38.5 Height: 35

AH: 24 SH: 17 SD: 22 IW: 24.5

Weight: 60 lbs Cube: 36.49

D	E	F	G	H	J	K COM	L	M	N	O	P	Q	R	S	T	U	(# above U) *	S Nail	M Nail
2475	2499	2523	2547	2571	2595	2619	2643	2667	2691	2715	2739	2763	2787	2811	2835	2859	24 (Riser) + 2859 (U)	90	105
Leather 1 3960		Leather 2 4155		Leather 3 4350		Leather 4 4545		Leather 5 4740		Leather 6 4935		Leather 8 6645		COL 2667		S Nail 90		M Nail 105	

Fabric SKU: 2725-01

Leather SKU: N/A

Standard Pillows: N/A Finish Req: N

Standard Cushions: Ultra Plush Standard Finish: Traditional

COM: 10 yards COL: N/A

Olivia Lounge Chair

Width: 34.5 Depth: 38.5 Height: 35

AH: 24 SH: 17 SD: 22 IW: 24.5

Weight: 55 lbs Cube: 36.49

D	E	F	G	H	J	K COM	L	M	N	O	P	Q	R	S	T	U	(# above U) *	S Nail	M Nail
2355	2385	2415	2445	2475	2505	2535	2565	2595	2625	2655	2685	2715	2745	2775	2805	2835	30 (Riser) + 2835 (U)	45	N/A
Leather 1 N/A		Leather 2 N/A		Leather 3 N/A		Leather 4 N/A		Leather 5 N/A		Leather 6 N/A		Leather 8 N/A		COL N/A		S Nail N/A		M Nail N/A	

Upholstery

**Pillows are not available on leather SKUs*

Fabric SKU: 2725-20

Leather SKU: N/A

Standard Pillows: N/A Finish Req: N

Standard Cushions: High Resiliency 20 Standard Finish: Traditional

COM: 4.25 yards COL: N/A

Olivia Ottoman

Width: 28 Depth: 21 Height: 16

AH: 0 SH: 16 SD: 0 IW: 0

Weight: 26 lbs Cube: 10.77

D	E	F	G	H	J	K COM	L	M	N	O	P	Q	R	S	T	U	(# above U) *	S Nail	M Nail
1050	1062	1074	1086	1098	1110	1122	1134	1146	1158	1170	1182	1194	1206	1218	1230	1242	12 (Riser) + 1242 (U)	N/A	N/A
Leather 1 N/A		Leather 2 N/A		Leather 3 N/A		Leather 4 N/A		Leather 5 N/A		Leather 6 N/A		Leather 8 N/A		COL N/A		S Nail N/A		M Nail N/A	

Fabric SKU: 2725-31

Leather SKU: N/A

Standard Pillows: N/A Finish Req: N

Standard Cushions: Ultra Plush Standard Finish: Traditional

COM: 10.25 yards COL: N/A

Olivia Swivel Chair

Width: 34.5 Depth: 38.5 Height: 35

AH: 24 SH: 17 SD: 22 IW: 24.5

Weight: 60 lbs Cube: 36.49

D	E	F	G	H	J	K COM	L	M	N	O	P	Q	R	S	T	U	(# above U) *	S Nail	M Nail
2430	2460	2490	2520	2550	2580	2610	2640	2670	2700	2730	2760	2790	2820	2850	2880	2910	30 (Riser) + 2910 (U)	45	N/A
Leather 1 N/A		Leather 2 N/A		Leather 3 N/A		Leather 4 N/A		Leather 5 N/A		Leather 6 N/A		Leather 8 N/A		COL N/A		S Nail N/A		M Nail N/A	

Fabric SKU: 2725-32

Leather SKU: N/A

Standard Pillows: N/A Finish Req: N

Standard Cushions: Ultra Plush Standard Finish: Traditional

COM: 10.25 yards COL: N/A

Olivia Swivel Glider

Width: 34.5 Depth: 38.5 Height: 35

AH: 24 SH: 17 SD: 22 IW: 24.5

Weight: 80 lbs Cube: 36.49

D	E	F	G	H	J	K COM	L	M	N	O	P	Q	R	S	T	U	(# above U) *	S Nail	M Nail
2580	2610	2640	2670	2700	2730	2760	2790	2820	2850	2880	2910	2940	2970	3000	3030	3060	30 (Riser) + 3060 (U)	45	N/A
Leather 1 N/A		Leather 2 N/A		Leather 3 N/A		Leather 4 N/A		Leather 5 N/A		Leather 6 N/A		Leather 8 N/A		COL N/A		S Nail N/A		M Nail N/A	

Fabric SKU: 2725-50

Leather SKU: N/A

Standard Pillows: (2) 18 x 18 Finish Req: N

Standard Cushions: Ultra Plush Standard Finish: Traditional

COM: 21 yards COL: N/A

Olivia Sofa

Width: 91.5 Depth: 41 Height: 37

AH: 25.5 SH: 20 SD: 23.5 IW: 78

Weight: 166 lbs Cube: 79.34

D	E	F	G	H	J	K COM	L	M	N	O	P	Q	R	S	T	U	(# above U) *	S Nail	M Nail
4275	4335	4395	4455	4515	4575	4635	4695	4755	4815	4875	4935	4995	5055	5115	5175	5235	60 (Riser) + 5235 (U)	60	N/A
Leather 1 N/A		Leather 2 N/A		Leather 3 N/A		Leather 4 N/A		Leather 5 N/A		Leather 6 N/A		Leather 8 N/A		COL N/A		S Nail N/A		M Nail N/A	

Fabric SKU: 2726-01

Leather SKU: N/A

Standard Pillows: N/A Finish Req: N

Standard Cushions: Ultra Plush Standard Finish: Contemporary

COM: 11.5 yards COL: N/A

Savannah Skirted Lounge Chair

Width: 31.5 Depth: 39 Height: 40.5

AH: 26 SH: 20 SD: 21.5 IW: 24

Weight: 87 lbs Cube: 36.49

D	E	F	G	H	J	K COM	L	M	N	O	P	Q	R	S	T	U	(# above U) *	S Nail	M Nail
2595	2628	2661	2694	2727	2760	2793	2826	2859	2892	2925	2958	2991	3024	3057	3090	3123	33 (Riser) + 3123 (U)	75	N/A
Leather 1 N/A		Leather 2 N/A		Leather 3 N/A		Leather 4 N/A		Leather 5 N/A		Leather 6 N/A		Leather 8 N/A		COL N/A		S Nail N/A		M Nail N/A	

Fabric SKU: 2726-20

Leather SKU: N/A

Standard Pillows: N/A Finish Req: N

Standard Cushions: Ultra Plush Standard Finish: Contemporary

COM: 4.25 yards COL: N/A

Savannah Skirted Ottoman

Width: 28 Depth: 21 Height: 18.5

AH: 0 SH: 0 SD: 0 IW: 0

Weight: 38 lbs Cube: 10.77

D	E	F	G	H	J	K COM	L	M	N	O	P	Q	R	S	T	U	(# above U) *	S Nail	M Nail
1050	1062	1074	1086	1098	1110	1122	1134	1146	1158	1170	1182	1194	1206	1218	1230	1242	12 (Riser) + 1242 (U)	N/A	N/A
Leather 1 N/A		Leather 2 N/A		Leather 3 N/A		Leather 4 N/A		Leather 5 N/A		Leather 6 N/A		Leather 8 N/A		COL N/A		S Nail N/A		M Nail N/A	

Upholstery

**Pillows are not available on leather SKUs*

Fabric SKU: **2726-31** Leather SKU: **N/A**
 SAVANNAH
Savannah Skirted Swivel Chair

Standard Pillows: N/A **Finish Req:** N
Standard Cushions: Ultra Plush **Standard Finish:**
COM: 11.5 yards **COL:** N/A

Width: 31.5 **Depth:** 39 **Height:** 40.5
AH: 26 **SH:** 20 **SD:** 21.5 **IW:** 24
Weight: 87 lbs **Cube:** 36.49

D	E	F	G	H	J	K COM	L	M	N	O	P	Q	R	S	T	U	(# above U) *	S Nail	M Nail
2640	2673	2706	2739	2772	2805	2838	2871	2904	2937	2970	3003	3036	3069	3102	3135	3168	33 (Riser) + 3168 (U)	N/A	N/A
Leather 1 N/A		Leather 2 N/A		Leather 3 N/A		Leather 4 N/A		Leather 5 N/A		Leather 6 N/A		Leather 8 N/A		COL N/A		S Nail N/A		M Nail N/A	

Fabric SKU: **2726-32** Leather SKU: **N/A**
 SAVANNAH
Savannah Skirted Swivel Glider

Standard Pillows: N/A **Finish Req:** N
Standard Cushions: Ultra Plush **Standard Finish:**
COM: 11.5 yards **COL:** N/A

Width: 31.5 **Depth:** 39 **Height:** 40.5
AH: 26 **SH:** 20 **SD:** 21.5 **IW:** 24
Weight: 87 lbs **Cube:** 41.32

D	E	F	G	H	J	K COM	L	M	N	O	P	Q	R	S	T	U	(# above U) *	S Nail	M Nail
2805	2838	2871	2904	2937	2970	3003	3036	3069	3102	3135	3168	3201	3234	3267	3300	3333	33 (Riser) + 3333 (U)	75	N/A
Leather 1 N/A		Leather 2 N/A		Leather 3 N/A		Leather 4 N/A		Leather 5 N/A		Leather 6 N/A		Leather 8 N/A		COL N/A		S Nail N/A		M Nail N/A	

Fabric SKU: **2726-50** Leather SKU: **N/A**
 SAVANNAH
Savannah Skirted Sofa

Standard Pillows: (2) 18 x 18 **Finish Req:** N
Standard Cushions: Ultra Plush **Standard Finish:** Traditional
COM: 22.75 yards **COL:** N/A

Two Backs over Two Seats
Width: 87.5 **Depth:** 40 **Height:** 41
AH: 27 **SH:** 22 **SD:** 21.5 **IW:** 79
Weight: 185 lbs **Cube:** 92.4

D	E	F	G	H	J	K COM	L	M	N	O	P	Q	R	S	T	U	(# above U) *	S Nail	M Nail
4200	4266	4332	4398	4464	4530	4596	4662	4728	4794	4860	4926	4992	5058	5124	5190	5256	66 (Riser) + 5256 (U)	75	N/A
Leather 1 N/A		Leather 2 N/A		Leather 3 N/A		Leather 4 N/A		Leather 5 N/A		Leather 6 N/A		Leather 8 N/A		COL N/A		S Nail N/A		M Nail N/A	

Fabric SKU: **2727-26** Leather SKU: **N/A**
 SAVANNAH
Savannah Right Arm Facing Chaise

Standard Pillows: (1) 18 x 18 **Finish Req:** N
Standard Cushions: Ultra Plush **Standard Finish:** Contemporary
COM: 12.75 yards **COL:** N/A
 This style is not intended to be used as a stand-alone item, it has been designed to connect with other matching sectional components.

Skirted
Width: 27.5 **Depth:** 69.5 **Height:** 41
AH: 26 **SH:** 22 **SD:** 51 **IW:** 24
Weight: 85 lbs **Cube:** 45.34

D	E	F	G	H	J	K COM	L	M	N	O	P	Q	R	S	T	U	(# above U) *	S Nail	M Nail
2955	2991	3027	3063	3099	3135	3171	3207	3243	3279	3315	3351	3387	3423	3459	3495	3531	36 (Riser) + 3531 (U)	60	N/A
Leather 1 N/A		Leather 2 N/A		Leather 3 N/A		Leather 4 N/A		Leather 5 N/A		Leather 6 N/A		Leather 8 N/A		COL N/A		S Nail N/A		M Nail N/A	

Fabric SKU: **2727-27** Leather SKU: **N/A**
 SAVANNAH
Savannah Left Arm Facing Chaise

Standard Pillows: (1) 18 x 18 **Finish Req:** N
Standard Cushions: Ultra Plush **Standard Finish:** Contemporary
COM: 12.75 yards **COL:** N/A
 This style is not intended to be used as a stand-alone item, it has been designed to connect with other matching sectional components.

Skirted
Width: 27.5 **Depth:** 69.5 **Height:** 41
AH: 26 **SH:** 22 **SD:** 51 **IW:** 24
Weight: 85 lbs **Cube:** 59.39

D	E	F	G	H	J	K COM	L	M	N	O	P	Q	R	S	T	U	(# above U) *	S Nail	M Nail
2955	2991	3027	3063	3099	3135	3171	3207	3243	3279	3315	3351	3387	3423	3459	3495	3531	36 (Riser) + 3531 (U)	60	N/A
Leather 1 N/A		Leather 2 N/A		Leather 3 N/A		Leather 4 N/A		Leather 5 N/A		Leather 6 N/A		Leather 8 N/A		COL N/A		S Nail N/A		M Nail N/A	

Fabric SKU: **2727-29** Leather SKU: **N/A**
 SAVANNAH
Savannah Skirted Corner Chair

Standard Pillows: N/A **Finish Req:** N
Standard Cushions: Ultra Plush **Standard Finish:** Contemporary
COM: 8.75 yards **COL:** N/A

Width: 40 **Depth:** 40 **Height:** 41
AH: 0 **SH:** 22 **SD:** 21.5 **IW:** 0
Weight: 75 lbs **Cube:** 37.96

D	E	F	G	H	J	K COM	L	M	N	O	P	Q	R	S	T	U	(# above U) *	S Nail	M Nail
2505	2529	2553	2577	2601	2625	2649	2673	2697	2721	2745	2769	2793	2817	2841	2865	2889	24 (Riser) + 2889 (U)	N/A	N/A
Leather 1 N/A		Leather 2 N/A		Leather 3 N/A		Leather 4 N/A		Leather 5 N/A		Leather 6 N/A		Leather 8 N/A		COL N/A		S Nail N/A		M Nail N/A	

Upholstery

**Pillows are not available on leather SKUs*

Fabric SKU: **2727-50** Leather SKU: **N/A**

SAVANNAH

Savannah Skirted Grand Sofa

Three Backs over Three Seats

Width: 93 **Depth:** 40 **Height:** 41

AH: 27 **SH:** 22 **SD:** 21.5 **IW:** 83.5

Weight: 243 lbs **Cube:** 92.4

Standard Pillows: (2) 18 x 18 **Finish Req:** N

Standard Cushions: Ultra Plush **Standard Finish:** Contemporary

COM: 23.75 yards **COL:** N/A

D 4485	E 4551	F 4617	G 4683	H 4749	J 4815	K COM 4881	L 4947	M 5013	N 5079	O 5145	P 5211	Q 5277	R 5343	S 5409	T 5475	U 5541	(# above U) * 66 (Riser) + 5541 (U)	S Nail 75	M Nail N/A
Leather 1 N/A		Leather 2 N/A		Leather 3 N/A		Leather 4 N/A		Leather 5 N/A		Leather 6 N/A		Leather 8 N/A		COL N/A		S Nail N/A		M Nail N/A	

Fabric SKU: **2727-51** Leather SKU: **N/A**

SAVANNAH

Savannah Right Arm Facing Sofa

Skirted

Width: 80 **Depth:** 40 **Height:** 41

AH: 26 **SH:** 22 **SD:** 21.5 **IW:** 76.5

Weight: 110 lbs **Cube:** 73.53

Standard Pillows: (1) 18 x 18 **Finish Req:** N

Standard Cushions: Ultra Plush **Standard Finish:** Contemporary

COM: 18.25 yards **COL:** N/A

This style is not intended to be used as a stand-alone item, it has been designed to connect with other matching sectional components.

D 4350	E 4401	F 4452	G 4503	H 4554	J 4605	K COM 4656	L 4707	M 4758	N 4809	O 4860	P 4911	Q 4962	R 5013	S 5064	T 5115	U 5166	(# above U) * 51 (Riser) + 5166 (U)	S Nail 75	M Nail N/A
Leather 1 N/A		Leather 2 N/A		Leather 3 N/A		Leather 4 N/A		Leather 5 N/A		Leather 6 N/A		Leather 8 N/A		COL N/A		S Nail N/A		M Nail N/A	

Fabric SKU: **2727-52** Leather SKU: **N/A**

SAVANNAH

Savannah Left Arm Facing Sofa

Skirted

Width: 80 **Depth:** 40 **Height:** 41

AH: 26 **SH:** 22 **SD:** 21.5 **IW:** 76.5

Weight: 110 lbs **Cube:** 79.34

Standard Pillows: (1) 18 x 18 **Finish Req:** N

Standard Cushions: Ultra Plush **Standard Finish:** Contemporary

COM: 18.25 yards **COL:** N/A

This style is not intended to be used as a stand-alone item, it has been designed to connect with other matching sectional components.

D 4350	E 4401	F 4452	G 4503	H 4554	J 4605	K COM 4656	L 4707	M 4758	N 4809	O 4860	P 4911	Q 4962	R 5013	S 5064	T 5115	U 5166	(# above U) * 51 (Riser) + 5166 (U)	S Nail 75	M Nail N/A
Leather 1 N/A		Leather 2 N/A		Leather 3 N/A		Leather 4 N/A		Leather 5 N/A		Leather 6 N/A		Leather 8 N/A		COL N/A		S Nail N/A		M Nail N/A	

Fabric SKU: **2727-53** Leather SKU: **N/A**

SAVANNAH

Savannah Right Arm Facing Corner Sofa

Skirted

Width: 89.5 **Depth:** 40 **Height:** 41

AH: 26 **SH:** 22 **SD:** 21.5 **IW:** 69

Weight: 237 lbs **Cube:** 102.13

Standard Pillows: (2) 18 x 18 **Finish Req:** N

Standard Cushions: Ultra Plush **Standard Finish:** Contemporary

COM: 22.5 yards **COL:** N/A

D 4575	E 4638	F 4701	G 4764	H 4827	J 4890	K COM 4953	L 5016	M 5079	N 5142	O 5205	P 5268	Q 5331	R 5394	S 5457	T 5520	U 5583	(# above U) * 63 (Riser) + 5583 (U)	S Nail 75	M Nail N/A
Leather 1 N/A		Leather 2 N/A		Leather 3 N/A		Leather 4 N/A		Leather 5 N/A		Leather 6 N/A		Leather 8 N/A		COL N/A		S Nail N/A		M Nail N/A	

Fabric SKU: **2727-54** Leather SKU: **N/A**

SAVANNAH

Savannah Left Arm Facing Corner Sofa

Skirted

Width: 89.5 **Depth:** 40 **Height:** 41

AH: 26 **SH:** 22 **SD:** 21.5 **IW:** 69

Weight: 123 lbs **Cube:** 92.4

Standard Pillows: (2) 18 x 18 **Finish Req:** N

Standard Cushions: Ultra Plush **Standard Finish:** Contemporary

COM: 22.5 yards **COL:** N/A

D 4575	E 4638	F 4701	G 4764	H 4827	J 4890	K COM 4953	L 5016	M 5079	N 5142	O 5205	P 5268	Q 5331	R 5394	S 5457	T 5520	U 5583	(# above U) * 63 (Riser) + 5583 (U)	S Nail 75	M Nail N/A
Leather 1 N/A		Leather 2 N/A		Leather 3 N/A		Leather 4 N/A		Leather 5 N/A		Leather 6 N/A		Leather 8 N/A		COL N/A		S Nail N/A		M Nail N/A	

Fabric SKU: **2727-71** Leather SKU: **N/A**

SAVANNAH

Savannah Right Arm Facing Loveseat

Skirted

Width: 53.5 **Depth:** 40 **Height:** 41

AH: 26 **SH:** 22 **SD:** 21.5 **IW:** 49.5

Weight: 73 lbs **Cube:** 66.52

Standard Pillows: (1) 18 x 18 **Finish Req:** N

Standard Cushions: Ultra Plush **Standard Finish:** Contemporary

COM: 14.5 yards **COL:** N/A

This style is not intended to be used as a stand-alone item, it has been designed to connect with other matching sectional components.

D 3300	E 3339	F 3378	G 3417	H 3456	J 3495	K COM 3534	L 3573	M 3612	N 3651	O 3690	P 3729	Q 3768	R 3807	S 3846	T 3885	U 3924	(# above U) * 39 (Riser) + 3924 (U)	S Nail 60	M Nail N/A
Leather 1 N/A		Leather 2 N/A		Leather 3 N/A		Leather 4 N/A		Leather 5 N/A		Leather 6 N/A		Leather 8 N/A		COL N/A		S Nail N/A		M Nail N/A	

Upholstery

**Pillows are not available on leather SKUs*

Fabric SKU: **2727-72** Leather SKU: **N/A**
 SAVANNAH
Savannah Left Arm Facing Loveseat
 Skirted
Width: 52 Depth: 40 Height: 41
AH: 26 SH: 22 SD: 21.5 IW: 49.5
Weight: 135 lbs Cube: 66.52

Standard Pillows: (1) 18 x 18 **Finish Req:** N
Standard Cushions: Ultra Plush **Standard Finish:** Contemporary
COM: 14.5 yards **COL:** N/A
 This style is not intended to be used as a stand-alone item, it has been designed to connect with other matching sectional components.

D	E	F	G	H	J	K COM	L	M	N	O	P	Q	R	S	T	U	(# above U) *	S Nail	M Nail
3300	3339	3378	3417	3456	3495	3534	3573	3612	3651	3690	3729	3768	3807	3846	3885	3924	39 (Riser) + 3924 (U)	60	N/A
Leather 1 N/A		Leather 2 N/A		Leather 3 N/A		Leather 4 N/A		Leather 5 N/A		Leather 6 N/A		Leather 8 N/A		COL N/A		S Nail N/A		M Nail N/A	

Fabric SKU: **2727-78** Leather SKU: **N/A**
 SAVANNAH
Savannah Armless Chair
 Skirted
Width: 25.5 Depth: 40 Height: 41
AH: 0 SH: 22 SD: 21.5 IW: 25
Weight: 48 lbs Cube: 24.2

Standard Pillows: N/A **Finish Req:** N
Standard Cushions: Ultra Plush **Standard Finish:** Contemporary
COM: 6.5 yards **COL:** N/A
 This style is not intended to be used as a stand-alone item, it has been designed to connect with other matching sectional components.

D	E	F	G	H	J	K COM	L	M	N	O	P	Q	R	S	T	U	(# above U) *	S Nail	M Nail
1980	1998	2016	2034	2052	2070	2088	2106	2124	2142	2160	2178	2196	2214	2232	2250	2268	18 (Riser) + 2268 (U)	N/A	N/A
Leather 1 N/A		Leather 2 N/A		Leather 3 N/A		Leather 4 N/A		Leather 5 N/A		Leather 6 N/A		Leather 8 N/A		COL N/A		S Nail N/A		M Nail N/A	

Fabric SKU: **2728-50** Leather SKU: **N/A**
 SAVANNAH
Savannah Skirted Sofa
 Two Backs over One Seat
Width: 87.5 Depth: 40 Height: 41
AH: 27 SH: 22 SD: 21.5 IW: 79
Weight: 185 lbs Cube: 92.4

Standard Pillows: (2) 18 x 18 **Finish Req:** N
Standard Cushions: Ultra Plush **Standard Finish:** Traditional
COM: 20.75 yards **COL:** N/A

D	E	F	G	H	J	K COM	L	M	N	O	P	Q	R	S	T	U	(# above U) *	S Nail	M Nail
4125	4191	4257	4323	4389	4455	4521	4587	4653	4719	4785	4851	4917	4983	5049	5115	5181	66 (Riser) + 5181 (U)	75	N/A
Leather 1 N/A		Leather 2 N/A		Leather 3 N/A		Leather 4 N/A		Leather 5 N/A		Leather 6 N/A		Leather 8 N/A		COL N/A		S Nail N/A		M Nail N/A	

Fabric SKU: **2731-01** Leather SKU: **L-2731-01**
Dyson Lounge Chair
Width: 34.5 Depth: 27.5 Height: 31
AH: 31 SH: 18.5 SD: 18.5 IW: 22
Weight: 53 lbs Cube: 29.69

Standard Pillows: N/A **Finish Req:** Y
Standard Cushions: High Resiliency 40 **Standard Finish:**
COM: 6.25 yards **COL:** 85 square feet

D	E	F	G	H	J	K COM	L	M	N	O	P	Q	R	S	T	U	(# above U) *	S Nail	M Nail
2340	2358	2376	2394	2412	2430	2448	2466	2484	2502	2520	2538	2556	2574	2592	2610	2628	18 (Riser) + 2628 (U)	N/A	N/A
Leather 1 3555		Leather 2 3690		Leather 3 3825		Leather 4 3960		Leather 5 4095		Leather 6 4230		Leather 8 5400		COL 2484		S Nail N/A		M Nail N/A	

Fabric SKU: **2731-50** Leather SKU: **L-2731-50**
Dyson Sofa
Width: 76.5 Depth: 27.5 Height: 31
AH: 31 SH: 18.5 SD: 18.5 IW: 64
Weight: 101 lbs Cube: 68.15

Standard Pillows: N/A **Finish Req:** Y
Standard Cushions: High Resiliency 40 **Standard Finish:**
COM: 7.25 yards **COL:** 141 square feet

D	E	F	G	H	J	K COM	L	M	N	O	P	Q	R	S	T	U	(# above U) *	S Nail	M Nail
3000	3024	3048	3072	3096	3120	3144	3168	3192	3216	3240	3264	3288	3312	3336	3360	3384	24 (Riser) + 3384 (U)	N/A	N/A
Leather 1 4425		Leather 2 4635		Leather 3 4845		Leather 4 5055		Leather 5 5265		Leather 6 5475		Leather 8 7425		COL 3192		S Nail N/A		M Nail N/A	

Fabric SKU: **2731-70** Leather SKU: **L-2731-70**
Dyson Loveseat
Width: 58 Depth: 28 Height: 30
AH: 30 SH: 18.5 SD: 19.5 IW: 49
Weight: 75 lbs Cube: 42.5

Standard Pillows: N/A **Finish Req:** Y
Standard Cushions: High Resiliency 40 **Standard Finish:**
COM: 6.5 yards **COL:** 124 square feet

D	E	F	G	H	J	K COM	L	M	N	O	P	Q	R	S	T	U	(# above U) *	S Nail	M Nail
2685	2703	2721	2739	2757	2775	2793	2811	2829	2847	2865	2883	2901	2919	2937	2955	2973	18 (Riser) + 2973 (U)	N/A	N/A
Leather 1 4050		Leather 2 4245		Leather 3 4440		Leather 4 4635		Leather 5 4830		Leather 6 5025		Leather 8 6735		COL 2829		S Nail N/A		M Nail N/A	

Upholstery

**Pillows are not available on leather SKUs*

Fabric SKU: 2733-01

Leather SKU: N/A

Standard Pillows: N/A Finish Req: Y

Standard Cushions: Blendown Standard Finish:

COM: 9.75 yards COL: N/A

Renwick Lounge chair

Width: 34.5 Depth: 41.75 Height: 35
 AH: 26.25 SH: 19.75 SD: 22.5 IW: 28.25
 Weight: 99 lbs Cube: 29.17

D	E	F	G	H	J	K COM	L	M	N	O	P	Q	R	S	T	U	(# above U) *	S Nail	M Nail
2550	2577	2604	2631	2658	2685	2712	2739	2766	2793	2820	2847	2874	2901	2928	2955	2982	27 (Riser) + 2982 (U)	N/A	N/A
Leather 1 N/A		Leather 2 N/A		Leather 3 N/A		Leather 4 N/A		Leather 5 N/A		Leather 6 N/A		Leather 8 N/A		COL N/A		S Nail N/A		M Nail N/A	

Fabric SKU: 2733-50

Leather SKU: N/A

Standard Pillows: (2) 20x20 Finish Req: Y

Standard Cushions: Blendown Standard Finish:

COM: 18.5 yards COL: N/A

Renwick Sofa

Three backs over three seat cushions
 Width: 94.5 Depth: 41.75 Height: 35
 AH: 26.25 SH: 19.75 SD: 22.5 IW: 88.5
 Weight: 197 lbs Cube: 79.91

D	E	F	G	H	J	K COM	L	M	N	O	P	Q	R	S	T	U	(# above U) *	S Nail	M Nail
4725	4779	4833	4887	4941	4995	5049	5103	5157	5211	5265	5319	5373	5427	5481	5535	5589	54 (Riser) + 5589 (U)	135	N/A
Leather 1 N/A		Leather 2 N/A		Leather 3 N/A		Leather 4 N/A		Leather 5 N/A		Leather 6 N/A		Leather 8 N/A		COL N/A		S Nail N/A		M Nail N/A	

Fabric SKU: 2735-50

Leather SKU: L-2735-50

Standard Pillows: (2) 18 x 18 Finish Req: Y

Standard Cushions: Ultra Plush Standard Finish:

COM: 12.75 yards COL: 197 square feet

Kyle Sofa

Width: 74.5 Depth: 35 Height: 31.5
 AH: 25.5 SH: 20 SD: 23 IW: 68
 Weight: 101 lbs Cube: 70.78

D	E	F	G	H	J	K COM	L	M	N	O	P	Q	R	S	T	U	(# above U) *	S Nail	M Nail
3705	3741	3777	3813	3849	3885	3921	3957	3993	4029	4065	4101	4137	4173	4209	4245	4281	36 (Riser) + 4281 (U)	105	120
Leather 1 6255		Leather 2 6555		Leather 3 6855		Leather 4 7155		Leather 5 7455		Leather 6 7755		Leather 8 10470		COL 3993		S Nail 105		M Nail 120	

Fabric SKU: 2736-50

Leather SKU: N/A

Standard Pillows: (2) 20x20 Finish Req: Y

Standard Cushions: Blendown Standard Finish:

COM: 17 yards COL: N/A

Renwick Sofa

Three Backs over one seat cushion
 Width: 94.5 Depth: 41.75 Height: 35
 AH: 26.25 SH: 19.75 SD: 22.5 IW: 88.5
 Weight: 197 lbs Cube: 79.91

D	E	F	G	H	J	K COM	L	M	N	O	P	Q	R	S	T	U	(# above U) *	S Nail	M Nail
4725	4779	4833	4887	4941	4995	5049	5103	5157	5211	5265	5319	5373	5427	5481	5535	5589	54 (Riser) + 5589 (U)	180	N/A
Leather 1 N/A		Leather 2 N/A		Leather 3 N/A		Leather 4 N/A		Leather 5 N/A		Leather 6 N/A		Leather 8 N/A		COL N/A		S Nail N/A		M Nail N/A	

Fabric SKU: 2737-01

Leather SKU: N/A

Standard Pillows: N/A Finish Req: Y

Standard Cushions: Blendown Standard Finish:

COM: 8.75 yards COL: N/A

Auburn Lounge chair

Width: 34 Depth: 42 Height: 36.5
 AH: 22.75 SH: 20.5 SD: 23 IW: 25
 Weight: 80 lbs Cube: 30.16

D	E	F	G	H	J	K COM	L	M	N	O	P	Q	R	S	T	U	(# above U) *	S Nail	M Nail
2385	2412	2439	2466	2493	2520	2547	2574	2601	2628	2655	2682	2709	2736	2763	2790	2817	27 (Riser) + 2817 (U)	135	150
Leather 1 N/A		Leather 2 N/A		Leather 3 N/A		Leather 4 N/A		Leather 5 N/A		Leather 6 N/A		Leather 8 N/A		COL N/A		S Nail N/A		M Nail N/A	

Fabric SKU: 2737-50

Leather SKU: N/A

Standard Pillows: (2) 18x18, (2) 20x20 weltless pillows Finish Req: Y

Standard Cushions: Blendown Standard Finish:

COM: 19 yards COL: N/A

Auburn Sofa

Three backs over three seat cushions
 Width: 94 Depth: 42 Height: 36.5
 AH: 22.75 SH: 20.5 SD: 23 IW: 85
 Weight: 170 lbs Cube: 83.39

D	E	F	G	H	J	K COM	L	M	N	O	P	Q	R	S	T	U	(# above U) *	S Nail	M Nail
4485	4542	4599	4656	4713	4770	4827	4884	4941	4998	5055	5112	5169	5226	5283	5340	5397	57 (Riser) + 5397 (U)	195	210
Leather 1 N/A		Leather 2 N/A		Leather 3 N/A		Leather 4 N/A		Leather 5 N/A		Leather 6 N/A		Leather 8 N/A		COL N/A		S Nail N/A		M Nail N/A	

Upholstery

**Pillows are not available on leather SKUs*

Fabric SKU: **2738-50**

Leather SKU: **N/A**

Standard Pillows: (2) 18x18, (2) 20x20 weltless pillows **Finish Req:** Y

Standard Cushions: Blendown **Standard Finish:**

COM: 18.25 yards **COL:** N/A

Auburn Sofa

Three Backs over one seat cushion

Width: 94 **Depth:** 42 **Height:** 36.5

AH: 22.75 **SH:** 20.5 **SD:** 23 **IW:** 85

Weight: 170 lbs **Cube:** 83.39

D	E	F	G	H	J	K COM	L	M	N	O	P	Q	R	S	T	U	(# above U) *	S Nail	M Nail
4485	4542	4599	4656	4713	4770	4827	4884	4941	4998	5055	5112	5169	5226	5283	5340	5397	57 (Riser) + 5397 (U)	195	210
Leather 1 N/A		Leather 2 N/A		Leather 3 N/A		Leather 4 N/A		Leather 5 N/A		Leather 6 N/A		Leather 8 N/A		COL N/A		S Nail N/A		M Nail N/A	

Fabric SKU: **2740-50**

Leather SKU: **L-2740-50**

Standard Pillows: (2) 20 x20 **Finish Req:** Y

Standard Cushions: Classic Plush **Standard Finish:**

COM: 15.75 yards **COL:** 242 square feet

Tally Sofa

Three Backs over One Seat

Width: 88 **Depth:** 38 **Height:** 37

AH: 24.5 **SH:** 19.5 **SD:** 22.5 **IW:** 80

Weight: 120 lbs **Cube:** 71.6

D	E	F	G	H	J	K COM	L	M	N	O	P	Q	R	S	T	U	(# above U) *	S Nail	M Nail
4275	4323	4371	4419	4467	4515	4563	4611	4659	4707	4755	4803	4851	4899	4947	4995	5043	48 (Riser) + 5043 (U)	135	N/A
Leather 1 6675		Leather 2 7050		Leather 3 7425		Leather 4 7800		Leather 5 8175		Leather 6 8550		Leather 8 11880		COL 4659		S Nail 135		M Nail N/A	

Fabric SKU: **2743-50**

Leather SKU: **L-2743-50**

Standard Pillows: (2) 20 x20 **Finish Req:** Y

Standard Cushions: Classic Plush **Standard Finish:**

COM: 17.25 yards **COL:** 248 square feet

Tally Sofa

Three Backs over Three Seats

Width: 88 **Depth:** 38 **Height:** 37

AH: 24.5 **SH:** 19.5 **SD:** 22.5 **IW:** 80

Weight: 120 lbs **Cube:** 71.6

D	E	F	G	H	J	K COM	L	M	N	O	P	Q	R	S	T	U	(# above U) *	S Nail	M Nail
4275	4323	4371	4419	4467	4515	4563	4611	4659	4707	4755	4803	4851	4899	4947	4995	5043	48 (Riser) + 5043 (U)	135	N/A
Leather 1 6675		Leather 2 7050		Leather 3 7425		Leather 4 7800		Leather 5 8175		Leather 6 8550		Leather 8 11970		COL 4659		S Nail 135		M Nail N/A	

Fabric SKU: **2744-50**

Leather SKU: **L-2744-50**

Standard Pillows: (2) 20 x 20 **Finish Req:** Y

Standard Cushions: Classic Plush **Standard Finish:**

COM: 14.75 yards **COL:** 220 square feet

Bronson Sofa

Tufted Back over Two Seats

Width: 89.75 **Depth:** 38.5 **Height:** 34

AH: 23 **SH:** 20 **SD:** 22 **IW:** 75.5

Weight: 130 lbs **Cube:** 67.98

D	E	F	G	H	J	K COM	L	M	N	O	P	Q	R	S	T	U	(# above U) *	S Nail	M Nail
4785	4827	4869	4911	4953	4995	5037	5079	5121	5163	5205	5247	5289	5331	5373	5415	5457	42 (Riser) + 5457 (U)	90	105
Leather 1 7185		Leather 2 7515		Leather 3 7845		Leather 4 8175		Leather 5 8505		Leather 6 8835		Leather 8 11865		COL 5121		S Nail 90		M Nail 105	

Fabric SKU: **2745-50**

Leather SKU: **N/A**

Standard Pillows: (2) 18 x 18 **Finish Req:** Y

Standard Cushions: Ultra Plush **Standard Finish:**

COM: 18 yards **COL:** N/A

SAVANNAH

Savannah Sofa with Tapered Leg

Two Backs over One Seat

Width: 87.5 **Depth:** 40 **Height:** 41

AH: 27 **SH:** 22 **SD:** 21.5 **IW:** 79

Weight: 165 lbs **Cube:** 79.34

D	E	F	G	H	J	K COM	L	M	N	O	P	Q	R	S	T	U	(# above U) *	S Nail	M Nail
4125	4179	4233	4287	4341	4395	4449	4503	4557	4611	4665	4719	4773	4827	4881	4935	4989	54 (Riser) + 4989 (U)	165	180
Leather 1 N/A		Leather 2 N/A		Leather 3 N/A		Leather 4 N/A		Leather 5 N/A		Leather 6 N/A		Leather 8 N/A		COL N/A		S Nail N/A		M Nail N/A	

Fabric SKU: **2746-01**

Leather SKU: **N/A**

Standard Pillows: N/A **Finish Req:** Y

Standard Cushions: Ultra Plush **Standard Finish:**

COM: 9.75 yards **COL:** N/A

SAVANNAH

Savannah Lounge Chair with Tapered Leg

Width: 31.5 **Depth:** 39 **Height:** 40.5

AH: 26 **SH:** 20 **SD:** 21.5 **IW:** 24

Weight: 87 lbs **Cube:** 34.38

D	E	F	G	H	J	K COM	L	M	N	O	P	Q	R	S	T	U	(# above U) *	S Nail	M Nail
2550	2577	2604	2631	2658	2685	2712	2739	2766	2793	2820	2847	2874	2901	2928	2955	2982	27 (Riser) + 2982 (U)	120	135
Leather 1 N/A		Leather 2 N/A		Leather 3 N/A		Leather 4 N/A		Leather 5 N/A		Leather 6 N/A		Leather 8 N/A		COL N/A		S Nail N/A		M Nail N/A	

Upholstery

**Pillows are not available on leather SKUs*

Fabric SKU: **2746-20** Leather SKU: **N/A**
 SAVANNAH
Savannah Ottoman with Tapered Leg

Standard Pillows: N/A **Finish Req:** Y
Standard Cushions: High Resiliency 30 **Standard Finish:**
COM: 3.25 yards **COL:** N/A

Width: 28 **Depth:** 21 **Height:** 18
AH: 0 **SH:** 18 **SD:** 21 **IW:** 0
Weight: 38 lbs **Cube:** 10.77

D	E	F	G	H	J	K COM	L	M	N	O	P	Q	R	S	T	U	(# above U) *	S Nail	M Nail
1080	1092	1104	1116	1128	1140	1152	1164	1176	1188	1200	1212	1224	1236	1248	1260	1272	12 (Riser) + 1272 (U)	30	45
Leather 1 N/A		Leather 2 N/A		Leather 3 N/A		Leather 4 N/A		Leather 5 N/A		Leather 6 N/A		Leather 8 N/A		COL N/A		S Nail N/A		M Nail N/A	

Fabric SKU: **2746-50** Leather SKU: **N/A**
 SAVANNAH
Savannah Sofa with Tapered Leg

Standard Pillows: (2) 18 x 18 **Finish Req:** Y
Standard Cushions: Ultra Plush **Standard Finish:**
COM: 19 yards **COL:** N/A

Two Backs over Two Seats
Width: 87.5 **Depth:** 40 **Height:** 41
AH: 27 **SH:** 22 **SD:** 21.5 **IW:** 79
Weight: 165 lbs **Cube:** 79.34

D	E	F	G	H	J	K COM	L	M	N	O	P	Q	R	S	T	U	(# above U) *	S Nail	M Nail
4125	4179	4233	4287	4341	4395	4449	4503	4557	4611	4665	4719	4773	4827	4881	4935	4989	54 (Riser) + 4989 (U)	165	180
Leather 1 N/A		Leather 2 N/A		Leather 3 N/A		Leather 4 N/A		Leather 5 N/A		Leather 6 N/A		Leather 8 N/A		COL N/A		S Nail N/A		M Nail N/A	

Fabric SKU: **2747-26** Leather SKU: **N/A**
 SAVANNAH
Savannah Right Arm Facing Chaise

Standard Pillows: (1) 18 x 18 **Finish Req:** Y
Standard Cushions: Ultra Plush **Standard Finish:**
COM: 10.5 yards **COL:** N/A

Tapered Leg
Width: 27.5 **Depth:** 69.5 **Height:** 41
AH: 26 **SH:** 22 **SD:** 51 **IW:** 24
Weight: 85 lbs **Cube:** 59.39

This style is not intended to be used as a stand-alone item, it has been designed to connect with other matching sectional components.

D	E	F	G	H	J	K COM	L	M	N	O	P	Q	R	S	T	U	(# above U) *	S Nail	M Nail
2925	2955	2985	3015	3045	3075	3105	3135	3165	3195	3225	3255	3285	3315	3345	3375	3405	30 (Riser) + 3405 (U)	90	105
Leather 1 N/A		Leather 2 N/A		Leather 3 N/A		Leather 4 N/A		Leather 5 N/A		Leather 6 N/A		Leather 8 N/A		COL N/A		S Nail N/A		M Nail N/A	

Fabric SKU: **2747-27** Leather SKU: **N/A**
 SAVANNAH
Savannah Left Arm Facing Chaise

Standard Pillows: (1) 18 x 18 **Finish Req:** Y
Standard Cushions: Ultra Plush **Standard Finish:**
COM: 9.75 yards **COL:** N/A

Tapered Leg
Width: 27.5 **Depth:** 69.5 **Height:** 41
AH: 26 **SH:** 22 **SD:** 51 **IW:** 24
Weight: 85 lbs **Cube:** 59.39

This style is not intended to be used as a stand-alone item, it has been designed to connect with other matching sectional components.

D	E	F	G	H	J	K COM	L	M	N	O	P	Q	R	S	T	U	(# above U) *	S Nail	M Nail
2925	2955	2985	3015	3045	3075	3105	3135	3165	3195	3225	3255	3285	3315	3345	3375	3405	30 (Riser) + 3405 (U)	90	105
Leather 1 N/A		Leather 2 N/A		Leather 3 N/A		Leather 4 N/A		Leather 5 N/A		Leather 6 N/A		Leather 8 N/A		COL N/A		S Nail N/A		M Nail N/A	

Fabric SKU: **2747-29** Leather SKU: **N/A**
 SAVANNAH
Savannah Corner Chair

Standard Pillows: N/A **Finish Req:** Y
Standard Cushions: Ultra Plush **Standard Finish:**
COM: 8.75 yards **COL:** N/A

Tapered Leg
Width: 40 **Depth:** 40 **Height:** 41
AH: 0 **SH:** 22 **SD:** 21.5 **IW:** 0
Weight: 75 lbs **Cube:** 37.96

D	E	F	G	H	J	K COM	L	M	N	O	P	Q	R	S	T	U	(# above U) *	S Nail	M Nail
2595	2619	2643	2667	2691	2715	2739	2763	2787	2811	2835	2859	2883	2907	2931	2955	2979	24 (Riser) + 2979 (U)	N/A	N/A
Leather 1 N/A		Leather 2 N/A		Leather 3 N/A		Leather 4 N/A		Leather 5 N/A		Leather 6 N/A		Leather 8 N/A		COL N/A		S Nail N/A		M Nail N/A	

Fabric SKU: **2747-50** Leather SKU: **N/A**
 SAVANNAH
Savannah Grand Sofa with Tapered Leg

Standard Pillows: (2) 18 x 18 **Finish Req:** Y
Standard Cushions: Ultra Plush **Standard Finish:**
COM: 20.75 yards **COL:** N/A

Three Backs over Three Seats
Width: 93 **Depth:** 40 **Height:** 41
AH: 27 **SH:** 22 **SD:** 21.5 **IW:** 83.5
Weight: 147 lbs **Cube:** 102.13

D	E	F	G	H	J	K COM	L	M	N	O	P	Q	R	S	T	U	(# above U) *	S Nail	M Nail
4455	4515	4575	4635	4695	4755	4815	4875	4935	4995	5055	5115	5175	5235	5295	5355	5415	60 (Riser) + 5415 (U)	165	180
Leather 1 N/A		Leather 2 N/A		Leather 3 N/A		Leather 4 N/A		Leather 5 N/A		Leather 6 N/A		Leather 8 N/A		COL N/A		S Nail N/A		M Nail N/A	

Upholstery

**Pillows are not available on leather SKUs*

Fabric SKU: **2747-51** Leather SKU: **N/A**

SAVANNAH

Savannah Right Arm Facing Sofa

Tapered Leg

Width: 80 Depth: 40 Height: 41

AH: 26 SH: 22 SD: 21.5 IW: 76.5

Weight: 110 lbs Cube: 73.53

Standard Pillows: (1) 18 x 18 **Finish Req:** Y

Standard Cushions: Ultra Plush **Standard Finish:**

COM: 15.75 yards **COL:** N/A

This style is not intended to be used as a stand-alone item, it has been designed to connect with other matching sectional components.

D	E	F	G	H	J	K COM	L	M	N	O	P	Q	R	S	T	U	(# above U) *	S Nail	M Nail
3975	4020	4065	4110	4155	4200	4245	4290	4335	4380	4425	4470	4515	4560	4605	4650	4695	45 (Riser) + 4695 (U)	75	N/A
Leather 1 N/A		Leather 2 N/A		Leather 3 N/A		Leather 4 N/A		Leather 5 N/A		Leather 6 N/A		Leather 8 N/A		COL N/A		S Nail N/A		M Nail N/A	

Fabric SKU: **2747-52** Leather SKU: **N/A**

SAVANNAH

Savannah Left Arm Facing Sofa

Tapered Leg

Width: 80 Depth: 40 Height: 41

AH: 26 SH: 22 SD: 21.5 IW: 76.5

Weight: 110 lbs Cube: 73.53

Standard Pillows: (1) 18 x 18 **Finish Req:** Y

Standard Cushions: Ultra Plush **Standard Finish:**

COM: 16 yards **COL:** N/A

This style is not intended to be used as a stand-alone item, it has been designed to connect with other matching sectional components.

D	E	F	G	H	J	K COM	L	M	N	O	P	Q	R	S	T	U	(# above U) *	S Nail	M Nail
3975	4020	4065	4110	4155	4200	4245	4290	4335	4380	4425	4470	4515	4560	4605	4650	4695	45 (Riser) + 4695 (U)	75	N/A
Leather 1 N/A		Leather 2 N/A		Leather 3 N/A		Leather 4 N/A		Leather 5 N/A		Leather 6 N/A		Leather 8 N/A		COL N/A		S Nail N/A		M Nail N/A	

Fabric SKU: **2747-53** Leather SKU: **N/A**

SAVANNAH

Savannah Right Arm Facing Corner Sofa

Tapered Leg

Width: 89.5 Depth: 40 Height: 41

AH: 26 SH: 22 SD: 21.5 IW: 69

Weight: 123 lbs Cube: 92.4

Standard Pillows: (2) 18 x 18 **Finish Req:** Y

Standard Cushions: Ultra Plush **Standard Finish:**

COM: 18.75 yards **COL:** N/A

D	E	F	G	H	J	K COM	L	M	N	O	P	Q	R	S	T	U	(# above U) *	S Nail	M Nail
4485	4539	4593	4647	4701	4755	4809	4863	4917	4971	5025	5079	5133	5187	5241	5295	5349	54 (Riser) + 5349 (U)	75	N/A
Leather 1 N/A		Leather 2 N/A		Leather 3 N/A		Leather 4 N/A		Leather 5 N/A		Leather 6 N/A		Leather 8 N/A		COL N/A		S Nail N/A		M Nail N/A	

Fabric SKU: **2747-54** Leather SKU: **N/A**

SAVANNAH

Savannah Left Arm Facing Corner Sofa

Tapered Leg

Width: 89.5 Depth: 40 Height: 41

AH: 26 SH: 22 SD: 21.5 IW: 69

Weight: 123 lbs Cube: 92.4

Standard Pillows: (2) 18 x 18 **Finish Req:** Y

Standard Cushions: Ultra Plush **Standard Finish:**

COM: 18.75 yards **COL:** N/A

D	E	F	G	H	J	K COM	L	M	N	O	P	Q	R	S	T	U	(# above U) *	S Nail	M Nail
4485	4539	4593	4647	4701	4755	4809	4863	4917	4971	5025	5079	5133	5187	5241	5295	5349	54 (Riser) + 5349 (U)	75	N/A
Leather 1 N/A		Leather 2 N/A		Leather 3 N/A		Leather 4 N/A		Leather 5 N/A		Leather 6 N/A		Leather 8 N/A		COL N/A		S Nail N/A		M Nail N/A	

Fabric SKU: **2747-71** Leather SKU: **N/A**

SAVANNAH

Savannah Right Arm Facing Loveseat

Tapered Leg

Width: 53.5 Depth: 40 Height: 41

AH: 26 SH: 22 SD: 21.5 IW: 49.5

Weight: 73 lbs Cube: 50.95

Standard Pillows: (1) 18 x 18 **Finish Req:** Y

Standard Cushions: Ultra Plush **Standard Finish:**

COM: 12.25 yards **COL:** N/A

This style is not intended to be used as a stand-alone item, it has been designed to connect with other matching sectional components.

D	E	F	G	H	J	K COM	L	M	N	O	P	Q	R	S	T	U	(# above U) *	S Nail	M Nail
3225	3261	3297	3333	3369	3405	3441	3477	3513	3549	3585	3621	3657	3693	3729	3765	3801	36 (Riser) + 3801 (U)	60	N/A
Leather 1 N/A		Leather 2 N/A		Leather 3 N/A		Leather 4 N/A		Leather 5 N/A		Leather 6 N/A		Leather 8 N/A		COL N/A		S Nail N/A		M Nail N/A	

Fabric SKU: **2747-72** Leather SKU: **N/A**

SAVANNAH

Savannah Left Arm Facing Loveseat

Tapered Leg

Width: 53.5 Depth: 40 Height: 41

AH: 26 SH: 22 SD: 21.5 IW: 49.5

Weight: 73 lbs Cube: 50.95

Standard Pillows: (1) 18 x 18 **Finish Req:** Y

Standard Cushions: Ultra Plush **Standard Finish:**

COM: 12.25 yards **COL:** N/A

This style is not intended to be used as a stand-alone item, it has been designed to connect with other matching sectional components.

D	E	F	G	H	J	K COM	L	M	N	O	P	Q	R	S	T	U	(# above U) *	S Nail	M Nail
3225	3261	3297	3333	3369	3405	3441	3477	3513	3549	3585	3621	3657	3693	3729	3765	3801	36 (Riser) + 3801 (U)	60	N/A
Leather 1 N/A		Leather 2 N/A		Leather 3 N/A		Leather 4 N/A		Leather 5 N/A		Leather 6 N/A		Leather 8 N/A		COL N/A		S Nail N/A		M Nail N/A	

Upholstery

**Pillows are not available on leather SKUs*

Fabric SKU: **2747-78** Leather SKU: **N/A**

SAVANNAH
Savannah Armless Chair

Tapered Leg
Width: 25.5 Depth: 40 Height: 41
AH: 0 SH: 22 SD: 21.5 IW: 0
Weight: 48 lbs Cube: 24.2

Standard Pillows: N/A **Finish Req:** Y
Standard Cushions: Ultra Plush **Standard Finish:**
COM: 6 yards **COL:** N/A

This style is not intended to be used as a stand-alone item, it has been designed to connect with other matching sectional components.

D	E	F	G	H	J	K COM	L	M	N	O	P	Q	R	S	T	U	(# above U) *	S Nail	M Nail
2055	2073	2091	2109	2127	2145	2163	2181	2199	2217	2235	2253	2271	2289	2307	2325	2343	18 (Riser) + 2343 (U)	45	60
Leather 1 N/A		Leather 2 N/A		Leather 3 N/A		Leather 4 N/A		Leather 5 N/A		Leather 6 N/A		Leather 8 N/A		COL N/A		S Nail N/A		M Nail N/A	

Fabric SKU: **2748-50** Leather SKU: **N/A**

DeMille Sofa
Two Backs over Two Seats
Width: 93 Depth: 39 Height: 38
AH: 25 SH: 20 SD: 20.5 IW: 76
Weight: 158 lbs Cube: 79.76

Standard Pillows: (2) 22 x 22 **Finish Req:** N
Standard Cushions: Classic Plush **Standard Finish:** Traditional
COM: 20 yards **COL:** N/A

D	E	F	G	H	J	K COM	L	M	N	O	P	Q	R	S	T	U	(# above U) *	S Nail	M Nail
4425	4479	4533	4587	4641	4695	4749	4803	4857	4911	4965	5019	5073	5127	5181	5235	5289	54 (Riser) + 5289 (U)	N/A	N/A
Leather 1 N/A		Leather 2 N/A		Leather 3 N/A		Leather 4 N/A		Leather 5 N/A		Leather 6 N/A		Leather 8 N/A		COL N/A		S Nail N/A		M Nail N/A	

Fabric SKU: **2749-01** Leather SKU: **N/A**

Smythe Lounge Chair
Width: 31.5 Depth: 41.5 Height: 36.5
AH: 25 SH: 19 SD: 22 IW: 24.5
Weight: 54 lbs Cube: 36.49

Standard Pillows: N/A **Finish Req:** Y
Standard Cushions: Ultra Plush **Standard Finish:**
COM: 9.25 yards **COL:** N/A

D	E	F	G	H	J	K COM	L	M	N	O	P	Q	R	S	T	U	(# above U) *	S Nail	M Nail
2475	2502	2529	2556	2583	2610	2637	2664	2691	2718	2745	2772	2799	2826	2853	2880	2907	27 (Riser) + 2907 (U)	90	105
Leather 1 N/A		Leather 2 N/A		Leather 3 N/A		Leather 4 N/A		Leather 5 N/A		Leather 6 N/A		Leather 8 N/A		COL N/A		S Nail N/A		M Nail N/A	

Fabric SKU: **2749-20** Leather SKU: **N/A**

Smythe Ottoman
Width: 28 Depth: 21 Height: 16.5
AH: 0 SH: 0 SD: 0 IW: 0
Weight: 26 lbs Cube: 10.77

Standard Pillows: N/A **Finish Req:** Y
Standard Cushions: High Resiliency 20 **Standard Finish:**
COM: 3.25 yards **COL:** N/A

D	E	F	G	H	J	K COM	L	M	N	O	P	Q	R	S	T	U	(# above U) *	S Nail	M Nail
1095	1107	1119	1131	1143	1155	1167	1179	1191	1203	1215	1227	1239	1251	1263	1275	1287	12 (Riser) + 1287 (U)	30	45
Leather 1 N/A		Leather 2 N/A		Leather 3 N/A		Leather 4 N/A		Leather 5 N/A		Leather 6 N/A		Leather 8 N/A		COL N/A		S Nail N/A		M Nail N/A	

Fabric SKU: **2749-50** Leather SKU: **N/A**

Smythe Sofa
Width: 81.5 Depth: 41.5 Height: 36.5
AH: 25 SH: 19 SD: 22 IW: 74.5
Weight: 115 lbs Cube: 79.34

Standard Pillows: (2) 18 x 18 **Finish Req:** Y
Standard Cushions: Ultra Plush **Standard Finish:**
COM: 19 yards **COL:** N/A

D	E	F	G	H	J	K COM	L	M	N	O	P	Q	R	S	T	U	(# above U) *	S Nail	M Nail
4185	4242	4299	4356	4413	4470	4527	4584	4641	4698	4755	4812	4869	4926	4983	5040	5097	57 (Riser) + 5097 (U)	135	150
Leather 1 N/A		Leather 2 N/A		Leather 3 N/A		Leather 4 N/A		Leather 5 N/A		Leather 6 N/A		Leather 8 N/A		COL N/A		S Nail N/A		M Nail N/A	

Fabric SKU: **2749-56** Leather SKU: **N/A**

Smythe Extra Long Sofa
Width: 106.5 Depth: 41.5 Height: 36.5
AH: 25 SH: 19 SD: 22 IW: 99.5
Weight: 135 lbs Cube: 81.85

Standard Pillows: (2) 18 x 18 **Finish Req:** Y
Standard Cushions: Ultra Plush **Standard Finish:**
COM: 24.25 yards **COL:** N/A

D	E	F	G	H	J	K COM	L	M	N	O	P	Q	R	S	T	U	(# above U) *	S Nail	M Nail
5025	5091	5157	5223	5289	5355	5421	5487	5553	5619	5685	5751	5817	5883	5949	6015	6081	66 (Riser) + 6081 (U)	165	180
Leather 1 N/A		Leather 2 N/A		Leather 3 N/A		Leather 4 N/A		Leather 5 N/A		Leather 6 N/A		Leather 8 N/A		COL N/A		S Nail N/A		M Nail N/A	

Upholstery

**Pillows are not available on leather SKUs*

Fabric SKU: 2749-70

Leather SKU: N/A

Standard Pillows: (2) 18 x 18 Finish Req: Y

Standard Cushions: Ultra Plush Standard Finish:

COM: 13.5 yards COL: N/A

Smythe Loveseat

Width: 57 Depth: 41.5 Height: 36.5

AH: 25 SH: 19 SD: 22 IW: 50

Weight: 99 lbs Cube: 61.76

D	E	F	G	H	J	K COM	L	M	N	O	P	Q	R	S	T	U	(# above U) *	S Nail	M Nail
3450	3492	3534	3576	3618	3660	3702	3744	3786	3828	3870	3912	3954	3996	4038	4080	4122	42 (Riser) + 4122 (U)	120	135
Leather 1 N/A		Leather 2 N/A		Leather 3 N/A		Leather 4 N/A		Leather 5 N/A		Leather 6 N/A		Leather 8 N/A		COL N/A		S Nail N/A		M Nail N/A	

Fabric SKU: 2751-01

Leather SKU: L-2751-01

Standard Pillows: N/A Finish Req: Y

Standard Cushions: Ultra Plush Standard Finish:

COM: 7.25 yards COL: 107 square feet

Wentworth Lounge Chair

Width: 31.5 Depth: 37 Height: 37.5

AH: 24.5 SH: 18.5 SD: 20.5 IW: 24

Weight: 59 lbs Cube: 29.69

D	E	F	G	H	J	K COM	L	M	N	O	P	Q	R	S	T	U	(# above U) *	S Nail	M Nail
2130	2151	2172	2193	2214	2235	2256	2277	2298	2319	2340	2361	2382	2403	2424	2445	2466	21 (Riser) + 2466 (U)	90	105
Leather 1 3555		Leather 2 3720		Leather 3 3885		Leather 4 4050		Leather 5 4215		Leather 6 4380		Leather 8 5850		COL 2298		S Nail 90		M Nail 105	

Fabric SKU: 2751-20

Leather SKU: L-2751-20

Standard Pillows: N/A Finish Req: Y

Standard Cushions: High Resiliency 20 Standard Finish:

COM: 3.25 yards COL: 51 square feet

Wentworth Ottoman

Width: 28 Depth: 21 Height: 16

AH: 0 SH: 0 SD: 0 IW: 0

Weight: 30 lbs Cube: 10.77

D	E	F	G	H	J	K COM	L	M	N	O	P	Q	R	S	T	U	(# above U) *	S Nail	M Nail
1050	1062	1074	1086	1098	1110	1122	1134	1146	1158	1170	1182	1194	1206	1218	1230	1242	12 (Riser) + 1242 (U)	30	N/A
Leather 1 1860		Leather 2 1935		Leather 3 2010		Leather 4 2085		Leather 5 2160		Leather 6 2235		Leather 8 2940		COL 1146		S Nail 30		M Nail N/A	

Fabric SKU: 2772-50

Leather SKU: N/A

Standard Pillows: (2) 18 x 18 Finish Req: Y

Standard Cushions: Ultra Plush Standard Finish:

COM: 16 yards COL: N/A

Dexter Sofa

Width: 73 Depth: 39 Height: 36.5

AH: 24 SH: 20.5 SD: 22 IW: 66

Weight: 145 lbs Cube: 73.53

D	E	F	G	H	J	K COM	L	M	N	O	P	Q	R	S	T	U	(# above U) *	S Nail	M Nail
4125	4170	4215	4260	4305	4350	4395	4440	4485	4530	4575	4620	4665	4710	4755	4800	4845	45 (Riser) + 4845 (U)	75	90
Leather 1 N/A		Leather 2 N/A		Leather 3 N/A		Leather 4 N/A		Leather 5 N/A		Leather 6 N/A		Leather 8 N/A		COL N/A		S Nail N/A		M Nail N/A	

Fabric SKU: 2776-50

Leather SKU: L-2776-50

Standard Pillows: (2) 20 x 20 Finish Req: Y

Standard Cushions: Ultra Plush Standard Finish:

COM: 13.5 yards COL: 214 square feet

Hendrix Sofa

2 Back over 1 Cushion Sofa

Width: 81 Depth: 37 Height: 36

AH: 24 SH: 20.5 SD: 22 IW: 70

Weight: 141 lbs Cube: 62.43

D	E	F	G	H	J	K COM	L	M	N	O	P	Q	R	S	T	U	(# above U) *	S Nail	M Nail
4875	4917	4959	5001	5043	5085	5127	5169	5211	5253	5295	5337	5379	5421	5463	5505	5547	42 (Riser) + 5547 (U)	75	90
Leather 1 7620		Leather 2 7950		Leather 3 8280		Leather 4 8610		Leather 5 8940		Leather 6 9270		Leather 8 12210		COL 5211		S Nail 75		M Nail 90	

Fabric SKU: 2777-01

Leather SKU: L-2777-01

Standard Pillows: N/A Finish Req: Y

Standard Cushions: Ultra Plush Standard Finish:

COM: 6.5 yards COL: 113 square feet

Hendrix Lounge Chair

Width: 32 Depth: 37 Height: 36

AH: 24 SH: 20.5 SD: 22 IW: 21

Weight: 60 lbs Cube: 36.49

D	E	F	G	H	J	K COM	L	M	N	O	P	Q	R	S	T	U	(# above U) *	S Nail	M Nail
2775	2796	2817	2838	2859	2880	2901	2922	2943	2964	2985	3006	3027	3048	3069	3090	3111	21 (Riser) + 3111 (U)	45	60
Leather 1 4290		Leather 2 4470		Leather 3 4650		Leather 4 4830		Leather 5 5010		Leather 6 5190		Leather 8 6750		COL 2943		S Nail 45		M Nail 60	

Upholstery

**Pillows are not available on leather SKUs*

Fabric SKU: 2777-20

Leather SKU: L-2777-20

Standard Pillows: N/A Finish Req: Y

Standard Cushions: Ultra Plush Standard Finish:

COM: 2.75 yards COL: 57 square feet

Hendrix Ottoman

Width: 28 Depth: 21 Height: 18.5

AH: 0 SH: 0 SD: 0 IW: 0

Weight: 19 lbs Cube: 6.29

D	E	F	G	H	J	K COM	L	M	N	O	P	Q	R	S	T	U	(# above U) *	S Nail	M Nail
1275	1284	1293	1302	1311	1320	1329	1338	1347	1356	1365	1374	1383	1392	1401	1410	1419	9 (Riser) + 1419 (U)	30	45
Leather 1 2085		Leather 2 2175		Leather 3 2265		Leather 4 2355		Leather 5 2445		Leather 6 2535		Leather 8 3330		COL 1347		S Nail 30		M Nail 45	

Fabric SKU: 2777-50

Leather SKU: L-2777-50

Standard Pillows: (2) 20 x 20 Finish Req: Y

Standard Cushions: Ultra Plush Standard Finish:

COM: 14.25 yards COL: 214 square feet

Hendrix 3 Back over 3 Cushion Sofa

Width: 81 Depth: 37 Height: 36

AH: 24 SH: 20.5 SD: 22 IW: 70

Weight: 141 lbs Cube: 79.34

D	E	F	G	H	J	K COM	L	M	N	O	P	Q	R	S	T	U	(# above U) *	S Nail	M Nail
4875	4917	4959	5001	5043	5085	5127	5169	5211	5253	5295	5337	5379	5421	5463	5505	5547	42 (Riser) + 5547 (U)	75	90
Leather 1 7620		Leather 2 7950		Leather 3 8280		Leather 4 8610		Leather 5 8940		Leather 6 9270		Leather 8 12210		COL 5211		S Nail 75		M Nail 90	

Fabric SKU: 2778-50

Leather SKU: L-2778-50

Standard Pillows: (2) 20 x 20 Finish Req: Y

Standard Cushions: Ultra Plush Standard Finish:

COM: 14.75 yards COL: 214 square feet

Hendrix 2 Back over 2 Cushion Sofa

Width: 81 Depth: 37 Height: 36

AH: 24 SH: 20.5 SD: 22 IW: 70

Weight: 141 lbs Cube: 79.34

D	E	F	G	H	J	K COM	L	M	N	O	P	Q	R	S	T	U	(# above U) *	S Nail	M Nail
4875	4917	4959	5001	5043	5085	5127	5169	5211	5253	5295	5337	5379	5421	5463	5505	5547	42 (Riser) + 5547 (U)	75	90
Leather 1 7620		Leather 2 7950		Leather 3 8280		Leather 4 8610		Leather 5 8940		Leather 6 9270		Leather 8 12210		COL 5211		S Nail 75		M Nail 90	

Fabric SKU: 2798-70

Leather SKU: N/A

Standard Pillows: (2) 18 x 18 Finish Req: Y

Standard Cushions: Ultra Plush Standard Finish:

COM: 17.25 yards COL: N/A

Anson Loveseat

Width: 67.5 Depth: 41 Height: 34

AH: 31.5 SH: 20.5 SD: 21 IW: 55.5

Weight: 130 lbs Cube: 66.52

D	E	F	G	H	J	K COM	L	M	N	O	P	Q	R	S	T	U	(# above U) *	S Nail	M Nail
3885	3933	3981	4029	4077	4125	4173	4221	4269	4317	4365	4413	4461	4509	4557	4605	4653	48 (Riser) + 4653 (U)	Std.	15
Leather 1 N/A		Leather 2 N/A		Leather 3 N/A		Leather 4 N/A		Leather 5 N/A		Leather 6 N/A		Leather 8 N/A		COL N/A		S Nail N/A		M Nail N/A	

Fabric SKU: 2820-50

Leather SKU: N/A

Standard Pillows: (2) 20x20 Finish Req: Y

Standard Cushions: Classic Plush Standard Finish:

COM: 20.5 yards COL: N/A

Sommet Sofa

Four Backs over four seat cushions

Width: 100 Depth: 34.5 Height: 37.5

AH: 23 SH: 19.25 SD: 20.5 IW: 93.25

Weight: 150 lbs Cube: 74.86

D	E	F	G	H	J	K COM	L	M	N	O	P	Q	R	S	T	U	(# above U) *	S Nail	M Nail
4650	4710	4770	4830	4890	4950	5010	5070	5130	5190	5250	5310	5370	5430	5490	5550	5610	60 (Riser) + 5610 (U)	120	N/A
Leather 1 N/A		Leather 2 N/A		Leather 3 N/A		Leather 4 N/A		Leather 5 N/A		Leather 6 N/A		Leather 8 N/A		COL N/A		S Nail N/A		M Nail N/A	

Fabric SKU: 2821-50

Leather SKU: N/A

Standard Pillows: (2) 20x20 Finish Req: Y

Standard Cushions: Classic Plush Standard Finish:

COM: 18.75 yards COL: N/A

Sommet Sofa

Two backs over two seat cushions

Width: 100 Depth: 34.5 Height: 37.5

AH: 23 SH: 19.25 SD: 20.5 IW: 93.25

Weight: 150 lbs Cube: 74.86

D	E	F	G	H	J	K COM	L	M	N	O	P	Q	R	S	T	U	(# above U) *	S Nail	M Nail
4275	4329	4383	4437	4491	4545	4599	4653	4707	4761	4815	4869	4923	4977	5031	5085	5139	54 (Riser) + 5139 (U)	120	N/A
Leather 1 N/A		Leather 2 N/A		Leather 3 N/A		Leather 4 N/A		Leather 5 N/A		Leather 6 N/A		Leather 8 N/A		COL N/A		S Nail N/A		M Nail N/A	

Upholstery

**Pillows are not available on leather SKUs*

Fabric SKU: **2963-50**

Leather SKU: **N/A**

KELLY

Kelly Skirted Sofa

Two Knife-edge Backs over One Seat

Width: 83 **Depth:** 38.5 **Height:** 41

AH: 25 **SH:** 21.5 **SD:** 21.5 **IW:** 76.5

Weight: 125 lbs **Cube:** 79.34

Standard Pillows: (2) 18 x 18 **Finish Req:** N

Standard Cushions: Ultra Plush **Standard Finish:** Traditional

COM: 19.25 yards **COL:** N/A

D	E	F	G	H	J	K COM	L	M	N	O	P	Q	R	S	T	U	(# above U) *	S Nail	M Nail
4275	4335	4395	4455	4515	4575	4635	4695	4755	4815	4875	4935	4995	5055	5115	5175	5235	60 (Riser) + 5235 (U)	Std.	N/A
Leather 1 N/A		Leather 2 N/A		Leather 3 N/A		Leather 4 N/A		Leather 5 N/A		Leather 6 N/A		Leather 8 N/A		COL N/A		S Nail N/A		M Nail N/A	

Fabric SKU: **2964-50**

Leather SKU: **N/A**

KELLY

Kelly Sofa with Tapered Leg

Two Knife-edge Backs over One Seat

Width: 83 **Depth:** 38.5 **Height:** 41

AH: 25 **SH:** 21.5 **SD:** 21.5 **IW:** 76.5

Weight: 125 lbs **Cube:** 87.69

Standard Pillows: (2) 18 x 18 **Finish Req:** Y

Standard Cushions: Ultra Plush **Standard Finish:**

COM: 16.5 yards **COL:** N/A

Standard with small nails around the inside arm

D	E	F	G	H	J	K COM	L	M	N	O	P	Q	R	S	T	U	(# above U) *	S Nail	M Nail
4275	4329	4383	4437	4491	4545	4599	4653	4707	4761	4815	4869	4923	4977	5031	5085	5139	54 (Riser) + 5139 (U)	Std.	N/A
Leather 1 N/A		Leather 2 N/A		Leather 3 N/A		Leather 4 N/A		Leather 5 N/A		Leather 6 N/A		Leather 8 N/A		COL N/A		S Nail N/A		M Nail N/A	

Fabric SKU: **2965-50**

Leather SKU: **N/A**

KELLY

Kelly Skirted Sofa

Two Boxed Backs over One Seat

Width: 83 **Depth:** 38.5 **Height:** 41

AH: 25 **SH:** 21.5 **SD:** 21.5 **IW:** 76.5

Weight: 125 lbs **Cube:** 87.69

Standard Pillows: (2) 18 x 18 **Finish Req:** N

Standard Cushions: Ultra Plush **Standard Finish:**

COM: 19.25 yards **COL:** N/A

Standard with small nails around the inside arm

D	E	F	G	H	J	K COM	L	M	N	O	P	Q	R	S	T	U	(# above U) *	S Nail	M Nail
4275	4335	4395	4455	4515	4575	4635	4695	4755	4815	4875	4935	4995	5055	5115	5175	5235	60 (Riser) + 5235 (U)	Std.	N/A
Leather 1 N/A		Leather 2 N/A		Leather 3 N/A		Leather 4 N/A		Leather 5 N/A		Leather 6 N/A		Leather 8 N/A		COL N/A		S Nail N/A		M Nail N/A	

Fabric SKU: **2966-50**

Leather SKU: **N/A**

KELLY

Kelly Sofa with Tapered Leg

Two Boxed Backs over One Seat

Width: 83 **Depth:** 38.5 **Height:** 41

AH: 25 **SH:** 21.5 **SD:** 21.5 **IW:** 76.5

Weight: 125 lbs **Cube:** 87.69

Standard Pillows: (2) 18 x 18 **Finish Req:** Y

Standard Cushions: Ultra Plush **Standard Finish:**

COM: 16.25 yards **COL:** N/A

Standard with small nails around the inside arm

D	E	F	G	H	J	K COM	L	M	N	O	P	Q	R	S	T	U	(# above U) *	S Nail	M Nail
4275	4329	4383	4437	4491	4545	4599	4653	4707	4761	4815	4869	4923	4977	5031	5085	5139	54 (Riser) + 5139 (U)	Std.	N/A
Leather 1 N/A		Leather 2 N/A		Leather 3 N/A		Leather 4 N/A		Leather 5 N/A		Leather 6 N/A		Leather 8 N/A		COL N/A		S Nail N/A		M Nail N/A	

Fabric SKU: **2973-01**

Leather SKU: **N/A**

KELLY

Kelly Skirted Lounge Chair

Knife-edge Back

Width: 29 **Depth:** 38.5 **Height:** 41

AH: 25 **SH:** 21.5 **SD:** 21.5 **IW:** 22

Weight: 61 lbs **Cube:** 26.49

Standard Pillows: N/A **Finish Req:** N

Standard Cushions: Ultra Plush **Standard Finish:** Traditional

COM: 9 yards **COL:** N/A

D	E	F	G	H	J	K COM	L	M	N	O	P	Q	R	S	T	U	(# above U) *	S Nail	M Nail
2250	2274	2298	2322	2346	2370	2394	2418	2442	2466	2490	2514	2538	2562	2586	2610	2634	24 (Riser) + 2634 (U)	Std.	N/A
Leather 1 N/A		Leather 2 N/A		Leather 3 N/A		Leather 4 N/A		Leather 5 N/A		Leather 6 N/A		Leather 8 N/A		COL N/A		S Nail N/A		M Nail N/A	

Fabric SKU: **2973-20**

Leather SKU: **N/A**

KELLY

Kelly Skirted Ottoman

Width: 24.5 **Depth:** 19.5 **Height:** 19.5

AH: 0 **SH:** 0 **SD:** 0 **IW:** 0

Weight: 23 lbs **Cube:** 10.77

Standard Pillows: N/A **Finish Req:** N

Standard Cushions: High Resiliency 30 **Standard Finish:** Traditional

COM: 3.5 yards **COL:** N/A

D	E	F	G	H	J	K COM	L	M	N	O	P	Q	R	S	T	U	(# above U) *	S Nail	M Nail
1050	1062	1074	1086	1098	1110	1122	1134	1146	1158	1170	1182	1194	1206	1218	1230	1242	12 (Riser) + 1242 (U)	N/A	N/A
Leather 1 N/A		Leather 2 N/A		Leather 3 N/A		Leather 4 N/A		Leather 5 N/A		Leather 6 N/A		Leather 8 N/A		COL N/A		S Nail N/A		M Nail N/A	

Upholstery

**Pillows are not available on leather SKUs*

Fabric SKU: **2973-26** Leather SKU: **N/A**

KELLY

Kelly Skirted Right Arm Chaise

One Knife-edge Back over One Seat

Width: 31.5 **Depth:** 69 **Height:** 41

AH: 25 **SH:** 21.5 **SD:** 50 **IW:** 31

Weight: 86 lbs **Cube:** 51.57

Standard Pillows: (1) 18 x 18 **Finish Req:** N

Standard Cushions: Ultra Plush **Standard Finish:** Traditional

COM: 12.75 yards **COL:** N/A

This long length transitional sectional has three loose back cushions over a generous bench seat cushion. Modified wings flow down from the back to slim arms accented with nail head trim. The tall skirt has kick pleat corners. This style is not intended to be used as a stand-alone item, it has been designed to connect with other matching sectional components.

D	E	F	G	H	J	K COM	L	M	N	O	P	Q	R	S	T	U	(# above U) *	S Nail	M Nail
2985	3021	3057	3093	3129	3165	3201	3237	3273	3309	3345	3381	3417	3453	3489	3525	3561	36 (Riser) + 3561 (U)	Std.	N/A
Leather 1 N/A		Leather 2 N/A		Leather 3 N/A		Leather 4 N/A		Leather 5 N/A		Leather 6 N/A		Leather 8 N/A		COL N/A		S Nail N/A		M Nail N/A	

Fabric SKU: **2973-27** Leather SKU: **N/A**

KELLY

Kelly Skirted Left Arm Chaise

One Knife-edge Back over One Seat

Width: 31.5 **Depth:** 69 **Height:** 41

AH: 25 **SH:** 21.5 **SD:** 50 **IW:** 31

Weight: 86 lbs **Cube:** 51.57

Standard Pillows: (1) 18 x 18 **Finish Req:** N

Standard Cushions: Ultra Plush **Standard Finish:** Traditional

COM: 12.75 yards **COL:** N/A

This long length transitional sectional has three loose back cushions over a generous bench seat cushion. Modified wings flow down from the back to slim arms accented with nail head trim. The tall skirt has kick pleat corners. This style is not intended to be used as a stand-alone item, it has been designed to connect with other matching sectional components.

D	E	F	G	H	J	K COM	L	M	N	O	P	Q	R	S	T	U	(# above U) *	S Nail	M Nail
2985	3021	3057	3093	3129	3165	3201	3237	3273	3309	3345	3381	3417	3453	3489	3525	3561	36 (Riser) + 3561 (U)	Std.	N/A
Leather 1 N/A		Leather 2 N/A		Leather 3 N/A		Leather 4 N/A		Leather 5 N/A		Leather 6 N/A		Leather 8 N/A		COL N/A		S Nail N/A		M Nail N/A	

Fabric SKU: **2973-29** Leather SKU: **N/A**

KELLY

Kelly Skirted Corner Chair

Two Knife-edge Backs over One Seat

Width: 38.5 **Depth:** 38.5 **Height:** 41

AH: 0 **SH:** 21.5 **SD:** 21.5 **IW:** 21.5

Weight: 78 lbs **Cube:** 35.16

Standard Pillows: (2) 18 x 18 **Finish Req:** N

Standard Cushions: Ultra Plush **Standard Finish:** Traditional

COM: 12.75 yards **COL:** N/A

This long length transitional sectional has three loose back cushions over a generous bench seat cushion. Modified wings flow down from the back to slim arms accented with nail head trim. The tall skirt has kick pleat corners.

D	E	F	G	H	J	K COM	L	M	N	O	P	Q	R	S	T	U	(# above U) *	S Nail	M Nail
2625	2661	2697	2733	2769	2805	2841	2877	2913	2949	2985	3021	3057	3093	3129	3165	3201	36 (Riser) + 3201 (U)	N/A	N/A
Leather 1 N/A		Leather 2 N/A		Leather 3 N/A		Leather 4 N/A		Leather 5 N/A		Leather 6 N/A		Leather 8 N/A		COL N/A		S Nail N/A		M Nail N/A	

Fabric SKU: **2973-31** Leather SKU: **N/A**

KELLY

Kelly Skirted Swivel Chair

Knife-edge Back

Width: 29 **Depth:** 38.5 **Height:** 41

AH: 25 **SH:** 21.5 **SD:** 21.5 **IW:** 22

Weight: 61 lbs **Cube:** 43.25

Standard Pillows: N/A **Finish Req:** N

Standard Cushions: Ultra Plush **Standard Finish:** Traditional

COM: 9.5 yards **COL:** N/A

D	E	F	G	H	J	K COM	L	M	N	O	P	Q	R	S	T	U	(# above U) *	S Nail	M Nail
2325	2349	2373	2397	2421	2445	2469	2493	2517	2541	2565	2589	2613	2637	2661	2685	2709	24 (Riser) + 2709 (U)	Std.	N/A
Leather 1 N/A		Leather 2 N/A		Leather 3 N/A		Leather 4 N/A		Leather 5 N/A		Leather 6 N/A		Leather 8 N/A		COL N/A		S Nail N/A		M Nail N/A	

Fabric SKU: **2973-32** Leather SKU: **N/A**

KELLY

Kelly Skirted Swivel Glider

Knife-edge Back

Width: 29 **Depth:** 38.5 **Height:** 41

AH: 25 **SH:** 21.5 **SD:** 21.5 **IW:** 22

Weight: 61 lbs **Cube:** 29.69

Standard Pillows: N/A **Finish Req:** N

Standard Cushions: Ultra Plush **Standard Finish:**

COM: 9 yards **COL:** N/A

D	E	F	G	H	J	K COM	L	M	N	O	P	Q	R	S	T	U	(# above U) *	S Nail	M Nail
2475	2499	2523	2547	2571	2595	2619	2643	2667	2691	2715	2739	2763	2787	2811	2835	2859	24 (Riser) + 2859 (U)	Std.	N/A
Leather 1 N/A		Leather 2 N/A		Leather 3 N/A		Leather 4 N/A		Leather 5 N/A		Leather 6 N/A		Leather 8 N/A		COL N/A		S Nail N/A		M Nail N/A	

Fabric SKU: **2973-50** Leather SKU: **N/A**

KELLY

Kelly Skirted Sofa

Three Knife-edge Backs over One Seat

Width: 93 **Depth:** 38.5 **Height:** 41

AH: 25 **SH:** 21.5 **SD:** 21.5 **IW:** 86.5

Weight: 143 lbs **Cube:** 92.4

Standard Pillows: (2) 18 x 18 **Finish Req:** N

Standard Cushions: Ultra Plush **Standard Finish:** Traditional

COM: 22.5 yards **COL:** N/A

This long length transitional sofa has three loose back cushions over a generous bench seat cushion. Modified wings flow down from the back to slim arms accented with nail head trim. The tall skirt has kick pleat corners.

D	E	F	G	H	J	K COM	L	M	N	O	P	Q	R	S	T	U	(# above U) *	S Nail	M Nail
4275	4341	4407	4473	4539	4605	4671	4737	4803	4869	4935	5001	5067	5133	5199	5265	5331	66 (Riser) + 5331 (U)	Std.	N/A
Leather 1 N/A		Leather 2 N/A		Leather 3 N/A		Leather 4 N/A		Leather 5 N/A		Leather 6 N/A		Leather 8 N/A		COL N/A		S Nail N/A		M Nail N/A	

Upholstery

**Pillows are not available on leather SKUs*

Fabric SKU: **2973-51** Leather SKU: **N/A**
KELLY

Kelly Skirted Right Arm Sofa

Three Knife-edge Backs over One Seat
Width: 89 **Depth:** 38.5 **Height:** 41
AH: 25 **SH:** 21.5 **SD:** 21.5 **IW:** 86
Weight: 133 lbs **Cube:** 92.4

Standard Pillows: (2) 18 x 18 **Finish Req:** N

Standard Cushions: Ultra Plush **Standard Finish:** Traditional

COM: 19 yards **COL:** N/A

This long length transitional sectional has three loose back cushions over a generous bench seat cushion. Modified wings flow down from the back to slim arms accented with nail head trim. The tall skirt has kick pleat corners. This style is not intended to be used as a stand-alone item, it has been designed to connect with other matching sectional components.

D	E	F	G	H	J	K COM	L	M	N	O	P	Q	R	S	T	U	(# above U) *	S Nail	M Nail
4125	4179	4233	4287	4341	4395	4449	4503	4557	4611	4665	4719	4773	4827	4881	4935	4989	54 (Riser) + 4989 (U)	Std.	N/A
Leather 1 N/A		Leather 2 N/A		Leather 3 N/A		Leather 4 N/A		Leather 5 N/A		Leather 6 N/A		Leather 8 N/A		COL N/A		S Nail N/A		M Nail N/A	

Fabric SKU: **2973-52** Leather SKU: **N/A**
KELLY

Kelly Skirted Left Arm Sofa

Three Knife-edge Backs over One Seat
Width: 89 **Depth:** 38.5 **Height:** 41
AH: 25 **SH:** 21.5 **SD:** 21.5 **IW:** 86
Weight: 133 lbs **Cube:** 81.3

Standard Pillows: (2) 18 x 18 **Finish Req:** N

Standard Cushions: Ultra Plush **Standard Finish:** Traditional

COM: 19 yards **COL:** N/A

This long length transitional sectional has three loose back cushions over a generous bench seat cushion. Modified wings flow down from the back to slim arms accented with nail head trim. The tall skirt has kick pleat corners. This style is not intended to be used as a stand-alone item, it has been designed to connect with other matching sectional components.

D	E	F	G	H	J	K COM	L	M	N	O	P	Q	R	S	T	U	(# above U) *	S Nail	M Nail
4125	4179	4233	4287	4341	4395	4449	4503	4557	4611	4665	4719	4773	4827	4881	4935	4989	54 (Riser) + 4989 (U)	Std.	N/A
Leather 1 N/A		Leather 2 N/A		Leather 3 N/A		Leather 4 N/A		Leather 5 N/A		Leather 6 N/A		Leather 8 N/A		COL N/A		S Nail N/A		M Nail N/A	

Fabric SKU: **2973-53** Leather SKU: **N/A**
KELLY

Kelly Skirted Right Arm Corner Sofa

Four Knife-edge Backs over One Seat
Width: 99 **Depth:** 38.5 **Height:** 41
AH: 25 **SH:** 21.5 **SD:** 21.5 **IW:** 79
Weight: 162 lbs **Cube:** 90.43

Standard Pillows: (2) 18 x 18 **Finish Req:** N

Standard Cushions: Ultra Plush **Standard Finish:** Traditional

COM: 24.5 yards **COL:** N/A

This long length transitional sectional has three loose back cushions over a generous bench seat cushion. Modified wings flow down from the back to slim arms accented with nail head trim. The tall skirt has kick pleat corners.

D	E	F	G	H	J	K COM	L	M	N	O	P	Q	R	S	T	U	(# above U) *	S Nail	M Nail
4650	4719	4788	4857	4926	4995	5064	5133	5202	5271	5340	5409	5478	5547	5616	5685	5754	69 (Riser) + 5754 (U)	Std.	N/A
Leather 1 N/A		Leather 2 N/A		Leather 3 N/A		Leather 4 N/A		Leather 5 N/A		Leather 6 N/A		Leather 8 N/A		COL N/A		S Nail N/A		M Nail N/A	

Fabric SKU: **2973-54** Leather SKU: **N/A**
KELLY

Kelly Skirted Left Arm Corner Sofa

Four Knife-edge Backs over One Seat
Width: 99 **Depth:** 38.5 **Height:** 41
AH: 25 **SH:** 21.5 **SD:** 21.5 **IW:** 79
Weight: 162 lbs **Cube:** 90.43

Standard Pillows: (2) 18 x 18 **Finish Req:** N

Standard Cushions: Ultra Plush **Standard Finish:** Traditional

COM: 24.5 yards **COL:** N/A

This long length transitional sectional has three loose back cushions over a generous bench seat cushion. Modified wings flow down from the back to slim arms accented with nail head trim. The tall skirt has kick pleat corners.

D	E	F	G	H	J	K COM	L	M	N	O	P	Q	R	S	T	U	(# above U) *	S Nail	M Nail
4650	4719	4788	4857	4926	4995	5064	5133	5202	5271	5340	5409	5478	5547	5616	5685	5754	69 (Riser) + 5754 (U)	Std.	N/A
Leather 1 N/A		Leather 2 N/A		Leather 3 N/A		Leather 4 N/A		Leather 5 N/A		Leather 6 N/A		Leather 8 N/A		COL N/A		S Nail N/A		M Nail N/A	

Fabric SKU: **2973-71** Leather SKU: **N/A**
KELLY

Kelly Skirted Right Arm Loveseat

Two Knife-edge Backs over One Seat
Width: 61.25 **Depth:** 38.5 **Height:** 41
AH: 25 **SH:** 21.5 **SD:** 21.5 **IW:** 58.25
Weight: 101 lbs **Cube:** 55.95

Standard Pillows: (2) 18 x 18 **Finish Req:** N

Standard Cushions: Ultra Plush **Standard Finish:** Traditional

COM: 16.5 yards **COL:** N/A

This long length transitional sectional has three loose back cushions over a generous bench seat cushion. Modified wings flow down from the back to slim arms accented with nail head trim. The tall skirt has kick pleat corners. This style is not intended to be used as a stand-alone item, it has been designed to connect with other matching sectional components.

D	E	F	G	H	J	K COM	L	M	N	O	P	Q	R	S	T	U	(# above U) *	S Nail	M Nail
3300	3348	3396	3444	3492	3540	3588	3636	3684	3732	3780	3828	3876	3924	3972	4020	4068	48 (Riser) + 4068 (U)	Std.	N/A
Leather 1 N/A		Leather 2 N/A		Leather 3 N/A		Leather 4 N/A		Leather 5 N/A		Leather 6 N/A		Leather 8 N/A		COL N/A		S Nail N/A		M Nail N/A	

Fabric SKU: **2973-72** Leather SKU: **N/A**
KELLY

Kelly Skirted Left Arm Loveseat

Two Knife-edge Backs over One Seat
Width: 61.25 **Depth:** 38.5 **Height:** 41
AH: 25 **SH:** 21.5 **SD:** 21.5 **IW:** 58.25
Weight: 101 lbs **Cube:** 55.95

Standard Pillows: (2) 18 x 18 **Finish Req:** N

Standard Cushions: Ultra Plush **Standard Finish:** Traditional

COM: 16.5 yards **COL:** N/A

This long length transitional sectional has three loose back cushions over a generous bench seat cushion. Modified wings flow down from the back to slim arms accented with nail head trim. The tall skirt has kick pleat corners. This style is not intended to be used as a stand-alone item, it has been designed to connect with other matching sectional components.

D	E	F	G	H	J	K COM	L	M	N	O	P	Q	R	S	T	U	(# above U) *	S Nail	M Nail
3300	3348	3396	3444	3492	3540	3588	3636	3684	3732	3780	3828	3876	3924	3972	4020	4068	48 (Riser) + 4068 (U)	Std.	N/A
Leather 1 N/A		Leather 2 N/A		Leather 3 N/A		Leather 4 N/A		Leather 5 N/A		Leather 6 N/A		Leather 8 N/A		COL N/A		S Nail N/A		M Nail N/A	

Upholstery

**Pillows are not available on leather SKUs*

Fabric SKU: **2973-78** Leather SKU: **N/A**
KELLY

Kelly Skirted Armless Sectional Chair

One Knife-edge Back over One Seat

Width: 28 **Depth:** 38.5 **Height:** 41

AH: 0 **SH:** 21.5 **SD:** 21.5 **IW:** 27.75

Weight: 30 lbs **Cube:** 25.57

Standard Pillows: N/A **Finish Req:** N

Standard Cushions: Ultra Plush **Standard Finish:** Traditional

COM: 9.5 yards **COL:** N/A

This long length transitional sectional has three loose back cushions over a generous bench seat cushion. Modified wings flow down from the back to slim arms accented with nail head trim. The tall skirt has kick pleat corners. This style is not intended to be used as a stand-alone item, it has been designed to connect with other matching sectional components.

D	E	F	G	H	J	K COM	L	M	N	O	P	Q	R	S	T	U	(# above U) *	S Nail	M Nail
1950	1977	2004	2031	2058	2085	2112	2139	2166	2193	2220	2247	2274	2301	2328	2355	2382	27 (Riser) + 2382 (U)	N/A	N/A
Leather 1 N/A		Leather 2 N/A		Leather 3 N/A		Leather 4 N/A		Leather 5 N/A		Leather 6 N/A		Leather 8 N/A		COL N/A		S Nail N/A		M Nail N/A	

Fabric SKU: **2974-01** Leather SKU: **N/A**
KELLY

Kelly Lounge Chair with Tapered Leg

Knife-edge Back

Width: 29 **Depth:** 38.5 **Height:** 41

AH: 25 **SH:** 21.5 **SD:** 21.5 **IW:** 22

Weight: 61 lbs **Cube:** 41.32

Standard Pillows: N/A **Finish Req:** Y

Standard Cushions: Ultra Plush **Standard Finish:**

COM: 7.25 yards **COL:** N/A

Standard with small nails around the inside arm

D	E	F	G	H	J	K COM	L	M	N	O	P	Q	R	S	T	U	(# above U) *	S Nail	M Nail
2250	2271	2292	2313	2334	2355	2376	2397	2418	2439	2460	2481	2502	2523	2544	2565	2586	21 (Riser) + 2586 (U)	Std.	N/A
Leather 1 N/A		Leather 2 N/A		Leather 3 N/A		Leather 4 N/A		Leather 5 N/A		Leather 6 N/A		Leather 8 N/A		COL N/A		S Nail N/A		M Nail N/A	

Fabric SKU: **2974-20** Leather SKU: **N/A**
KELLY

Kelly Ottoman with Tapered Leg

Width: 24.5 **Depth:** 19.5 **Height:** 19.5

AH: 0 **SH:** 0 **SD:** 0 **IW:** 0

Weight: 23 lbs **Cube:** 10.77

Standard Pillows: N/A **Finish Req:** Y

Standard Cushions: High Resiliency 30 **Standard Finish:**

COM: 2.5 yards **COL:** N/A

D	E	F	G	H	J	K COM	L	M	N	O	P	Q	R	S	T	U	(# above U) *	S Nail	M Nail
1050	1059	1068	1077	1086	1095	1104	1113	1122	1131	1140	1149	1158	1167	1176	1185	1194	9 (Riser) + 1194 (U)	N/A	N/A
Leather 1 N/A		Leather 2 N/A		Leather 3 N/A		Leather 4 N/A		Leather 5 N/A		Leather 6 N/A		Leather 8 N/A		COL N/A		S Nail N/A		M Nail N/A	

Fabric SKU: **2974-26** Leather SKU: **N/A**
KELLY

Kelly Right Arm Chaise with Tapered Leg

One Knife-edge Back over One Seat

Width: 31.5 **Depth:** 69 **Height:** 41

AH: 25 **SH:** 21.5 **SD:** 50 **IW:** 31

Weight: 86 lbs **Cube:** 51.57

Standard Pillows: (1) 18 x 18 **Finish Req:** Y

Standard Cushions: Ultra Plush **Standard Finish:**

COM: 12.25 yards **COL:** N/A

Standard with small nails around the inside arm. This style is not intended to be used as a stand-alone item, it has been designed to connect with other matching sectional components.

D	E	F	G	H	J	K COM	L	M	N	O	P	Q	R	S	T	U	(# above U) *	S Nail	M Nail
2985	3018	3051	3084	3117	3150	3183	3216	3249	3282	3315	3348	3381	3414	3447	3480	3513	33 (Riser) + 3513 (U)	Std.	N/A
Leather 1 N/A		Leather 2 N/A		Leather 3 N/A		Leather 4 N/A		Leather 5 N/A		Leather 6 N/A		Leather 8 N/A		COL N/A		S Nail N/A		M Nail N/A	

Fabric SKU: **2974-27** Leather SKU: **N/A**
KELLY

Kelly Left Arm Chaise with Tapered Leg

One Knife-edge Back over One Seat

Width: 31.5 **Depth:** 69 **Height:** 41

AH: 25 **SH:** 21.5 **SD:** 50 **IW:** 31

Weight: 86 lbs **Cube:** 51.57

Standard Pillows: (1) 18 x 18 **Finish Req:** Y

Standard Cushions: Ultra Plush **Standard Finish:**

COM: 12.25 yards **COL:** N/A

Standard with small nails around the inside arm. This style is not intended to be used as a stand-alone item, it has been designed to connect with other matching sectional components.

D	E	F	G	H	J	K COM	L	M	N	O	P	Q	R	S	T	U	(# above U) *	S Nail	M Nail
2985	3018	3051	3084	3117	3150	3183	3216	3249	3282	3315	3348	3381	3414	3447	3480	3513	33 (Riser) + 3513 (U)	Std.	N/A
Leather 1 N/A		Leather 2 N/A		Leather 3 N/A		Leather 4 N/A		Leather 5 N/A		Leather 6 N/A		Leather 8 N/A		COL N/A		S Nail N/A		M Nail N/A	

Fabric SKU: **2974-29** Leather SKU: **N/A**
KELLY

Kelly Corner Chair with Tapered Leg

Two Knife-edge Backs over One Seat

Width: 38.5 **Depth:** 38.5 **Height:** 41

AH: 0 **SH:** 21.5 **SD:** 21.5 **IW:** 21.5

Weight: 78 lbs **Cube:** 35.16

Standard Pillows: (2) 18 x 18 **Finish Req:** Y

Standard Cushions: Ultra Plush **Standard Finish:**

COM: 12 yards **COL:** N/A

Standard with small nails around the inside arm

D	E	F	G	H	J	K COM	L	M	N	O	P	Q	R	S	T	U	(# above U) *	S Nail	M Nail
2625	2658	2691	2724	2757	2790	2823	2856	2889	2922	2955	2988	3021	3054	3087	3120	3153	33 (Riser) + 3153 (U)	N/A	N/A
Leather 1 N/A		Leather 2 N/A		Leather 3 N/A		Leather 4 N/A		Leather 5 N/A		Leather 6 N/A		Leather 8 N/A		COL N/A		S Nail N/A		M Nail N/A	

Upholstery

**Pillows are not available on leather SKUs*

Fabric SKU: **2974-50** Leather SKU: **N/A**

KELLY

Kelly Sofa with Tapered Leg

Three Knife-edge Backs over One Seat

Width: 93 **Depth:** 38.5 **Height:** 41

AH: 25 **SH:** 21.5 **SD:** 21.5 **IW:** 86.5

Weight: 143 lbs **Cube:** 102.13

Standard Pillows: (2) 18 x 18 **Finish Req:** Y

Standard Cushions: Ultra Plush **Standard Finish:**

COM: 19.75 yards **COL:** N/A

Standard with small nails around the inside arm

D	E	F	G	H	J	K COM	L	M	N	O	P	Q	R	S	T	U	(# above U) *	S Nail	M Nail
4275	4335	4395	4455	4515	4575	4635	4695	4755	4815	4875	4935	4995	5055	5115	5175	5235	60 (Riser) + 5235 (U)	Std.	N/A
Leather 1 N/A		Leather 2 N/A		Leather 3 N/A		Leather 4 N/A		Leather 5 N/A		Leather 6 N/A		Leather 8 N/A		COL N/A		S Nail N/A		M Nail N/A	

Fabric SKU: **2974-51** Leather SKU: **N/A**

KELLY

Kelly Right Arm Sofa with Tapered Leg

Three Knife-edge Backs over One Seat

Width: 89 **Depth:** 38.5 **Height:** 41

AH: 25 **SH:** 21.5 **SD:** 21.5 **IW:** 86

Weight: 133 lbs **Cube:** 81.3

Standard Pillows: (2) 18 x 18 **Finish Req:** Y

Standard Cushions: Ultra Plush **Standard Finish:**

COM: 16.5 yards **COL:** N/A

Standard with small nails around the inside arm. This style is not intended to be used as a stand-alone item, it has been designed to connect with other matching sectional components.

D	E	F	G	H	J	K COM	L	M	N	O	P	Q	R	S	T	U	(# above U) *	S Nail	M Nail
4125	4173	4221	4269	4317	4365	4413	4461	4509	4557	4605	4653	4701	4749	4797	4845	4893	48 (Riser) + 4893 (U)	Std.	N/A
Leather 1 N/A		Leather 2 N/A		Leather 3 N/A		Leather 4 N/A		Leather 5 N/A		Leather 6 N/A		Leather 8 N/A		COL N/A		S Nail N/A		M Nail N/A	

Fabric SKU: **2974-52** Leather SKU: **N/A**

KELLY

Kelly Left Arm Sofa with Tapered Leg

Three Knife-edge Backs over One Seat

Width: 89 **Depth:** 38.5 **Height:** 41

AH: 25 **SH:** 21.5 **SD:** 21.5 **IW:** 86

Weight: 133 lbs **Cube:** 81.3

Standard Pillows: (2) 18 x 18 **Finish Req:** Y

Standard Cushions: Ultra Plush **Standard Finish:**

COM: 16.5 yards **COL:** N/A

Standard with small nails around the inside arm. This style is not intended to be used as a stand-alone item, it has been designed to connect with other matching sectional components.

D	E	F	G	H	J	K COM	L	M	N	O	P	Q	R	S	T	U	(# above U) *	S Nail	M Nail
4125	4173	4221	4269	4317	4365	4413	4461	4509	4557	4605	4653	4701	4749	4797	4845	4893	48 (Riser) + 4893 (U)	Std.	N/A
Leather 1 N/A		Leather 2 N/A		Leather 3 N/A		Leather 4 N/A		Leather 5 N/A		Leather 6 N/A		Leather 8 N/A		COL N/A		S Nail N/A		M Nail N/A	

Fabric SKU: **2974-53** Leather SKU: **N/A**

KELLY

Kelly Right Arm Corner Sofa with Tapered Leg

Four Knife-edge Backs over One Seat

Width: 99 **Depth:** 38.5 **Height:** 41

AH: 25 **SH:** 21.5 **SD:** 21.5 **IW:** 79

Weight: 162 lbs **Cube:** 90.43

Standard Pillows: (2) 18 x 18 **Finish Req:** Y

Standard Cushions: Ultra Plush **Standard Finish:**

COM: 21 yards **COL:** N/A

Standard with small nails around the inside arm

D	E	F	G	H	J	K COM	L	M	N	O	P	Q	R	S	T	U	(# above U) *	S Nail	M Nail
4650	4710	4770	4830	4890	4950	5010	5070	5130	5190	5250	5310	5370	5430	5490	5550	5610	60 (Riser) + 5610 (U)	Std.	N/A
Leather 1 N/A		Leather 2 N/A		Leather 3 N/A		Leather 4 N/A		Leather 5 N/A		Leather 6 N/A		Leather 8 N/A		COL N/A		S Nail N/A		M Nail N/A	

Fabric SKU: **2974-54** Leather SKU: **N/A**

KELLY

Kelly Left Arm Corner Sofa with Tapered Leg

Four Knife-edge Backs over One Seat

Width: 99 **Depth:** 38.5 **Height:** 41

AH: 25 **SH:** 21.5 **SD:** 21.5 **IW:** 79

Weight: 162 lbs **Cube:** 90.43

Standard Pillows: (2) 18 x 18 **Finish Req:** Y

Standard Cushions: Ultra Plush **Standard Finish:**

COM: 21 yards **COL:** N/A

Standard with small nails around the inside arm

D	E	F	G	H	J	K COM	L	M	N	O	P	Q	R	S	T	U	(# above U) *	S Nail	M Nail
4650	4710	4770	4830	4890	4950	5010	5070	5130	5190	5250	5310	5370	5430	5490	5550	5610	60 (Riser) + 5610 (U)	Std.	N/A
Leather 1 N/A		Leather 2 N/A		Leather 3 N/A		Leather 4 N/A		Leather 5 N/A		Leather 6 N/A		Leather 8 N/A		COL N/A		S Nail N/A		M Nail N/A	

Fabric SKU: **2974-71** Leather SKU: **N/A**

KELLY

Kelly Right Arm Loveseat with Tapered Leg

Two Knife-edge Backs over One Seat

Width: 61.25 **Depth:** 38.5 **Height:** 41

AH: 25 **SH:** 21.5 **SD:** 21.5 **IW:** 58.25

Weight: 101 lbs **Cube:** 55.95

Standard Pillows: (2) 18 x 18 **Finish Req:** Y

Standard Cushions: Ultra Plush **Standard Finish:**

COM: 14.75 yards **COL:** N/A

Standard with small nails around the inside arm. This style is not intended to be used as a stand-alone item, it has been designed to connect with other matching sectional components.

D	E	F	G	H	J	K COM	L	M	N	O	P	Q	R	S	T	U	(# above U) *	S Nail	M Nail
3300	3342	3384	3426	3468	3510	3552	3594	3636	3678	3720	3762	3804	3846	3888	3930	3972	42 (Riser) + 3972 (U)	Std.	N/A
Leather 1 N/A		Leather 2 N/A		Leather 3 N/A		Leather 4 N/A		Leather 5 N/A		Leather 6 N/A		Leather 8 N/A		COL N/A		S Nail N/A		M Nail N/A	

Upholstery

**Pillows are not available on leather SKUs*

Fabric SKU: **2974-72** Leather SKU: **N/A**
KELLY

Kelly Left Arm Loveseat with Tapered Leg

Two Knife-edge Backs over One Seat
Width: 61.25 **Depth:** 38.5 **Height:** 41
AH: 25 **SH:** 21.5 **SD:** 21.5 **IW:** 58.25
Weight: 101 lbs **Cube:** 55.95

Standard Pillows: (2) 18 x 18 **Finish Req:** Y
Standard Cushions: Ultra Plush **Standard Finish:**
COM: 14.75 yards **COL:** N/A
Standard with small nails around the inside arm. This style is not intended to be used as a stand-alone item, it has been designed to connect with other matching sectional components.

D	E	F	G	H	J	K COM	L	M	N	O	P	Q	R	S	T	U	(# above U) *	S Nail	M Nail
3300	3342	3384	3426	3468	3510	3552	3594	3636	3678	3720	3762	3804	3846	3888	3930	3972	42 (Riser) + 3972 (U)	Std.	N/A
Leather 1		Leather 2		Leather 3		Leather 4		Leather 5		Leather 6		Leather 8		COL		S Nail		M Nail	
N/A		N/A		N/A		N/A		N/A		N/A		N/A		N/A		N/A		N/A	

Fabric SKU: **2974-78** Leather SKU: **N/A**
KELLY

Kelly Armless Sectional Chair with Tapered Leg

One Knife-edge Back over One Seat
Width: 28 **Depth:** 38.5 **Height:** 41
AH: 0 **SH:** 21.5 **SD:** 21.5 **IW:** 27.75
Weight: 30 lbs **Cube:** 25.57

Standard Pillows: N/A **Finish Req:** Y
Standard Cushions: Ultra Plush **Standard Finish:**
COM: 8.75 yards **COL:** N/A
This style is not intended to be used as a stand-alone item, it has been designed to connect with other matching sectional components.

D	E	F	G	H	J	K COM	L	M	N	O	P	Q	R	S	T	U	(# above U) *	S Nail	M Nail
1950	1974	1998	2022	2046	2070	2094	2118	2142	2166	2190	2214	2238	2262	2286	2310	2334	24 (Riser) + 2334 (U)	N/A	N/A
Leather 1		Leather 2		Leather 3		Leather 4		Leather 5		Leather 6		Leather 8		COL		S Nail		M Nail	
N/A		N/A		N/A		N/A		N/A		N/A		N/A		N/A		N/A		N/A	

Fabric SKU: **2975-01** Leather SKU: **N/A**
KELLY

Kelly Skirted Lounge Chair

Boxed Back
Width: 29 **Depth:** 38.5 **Height:** 41
AH: 25 **SH:** 21.5 **SD:** 21.5 **IW:** 22
Weight: 61 lbs **Cube:** 41.32

Standard Pillows: N/A **Finish Req:** N
Standard Cushions: Ultra Plush **Standard Finish:** Traditional
COM: 9 yards **COL:** N/A
Standard with small nails around the inside arm

D	E	F	G	H	J	K COM	L	M	N	O	P	Q	R	S	T	U	(# above U) *	S Nail	M Nail
2250	2274	2298	2322	2346	2370	2394	2418	2442	2466	2490	2514	2538	2562	2586	2610	2634	24 (Riser) + 2634 (U)	Std.	N/A
Leather 1		Leather 2		Leather 3		Leather 4		Leather 5		Leather 6		Leather 8		COL		S Nail		M Nail	
N/A		N/A		N/A		N/A		N/A		N/A		N/A		N/A		N/A		N/A	

Fabric SKU: **2975-26** Leather SKU: **N/A**
KELLY

Kelly Skirted Right Arm Chaise

One Boxed Back over One Seat
Width: 31.5 **Depth:** 69 **Height:** 41
AH: 25 **SH:** 21.5 **SD:** 50 **IW:** 31
Weight: 86 lbs **Cube:** 51.57

Standard Pillows: (1) 18 x 18 **Finish Req:** N
Standard Cushions: Ultra Plush **Standard Finish:** Traditional
COM: 14.75 yards **COL:** N/A
Standard with small nails around the inside arm. This style is not intended to be used as a stand-alone item, it has been designed to connect with other matching sectional components.

D	E	F	G	H	J	K COM	L	M	N	O	P	Q	R	S	T	U	(# above U) *	S Nail	M Nail
2985	3027	3069	3111	3153	3195	3237	3279	3321	3363	3405	3447	3489	3531	3573	3615	3657	42 (Riser) + 3657 (U)	Std.	N/A
Leather 1		Leather 2		Leather 3		Leather 4		Leather 5		Leather 6		Leather 8		COL		S Nail		M Nail	
N/A		N/A		N/A		N/A		N/A		N/A		N/A		N/A		N/A		N/A	

Fabric SKU: **2975-27** Leather SKU: **N/A**
KELLY

Kelly Skirted Left Arm Chaise

One Boxed Back over One Seat
Width: 31.5 **Depth:** 69 **Height:** 41
AH: 25 **SH:** 21.5 **SD:** 50 **IW:** 31
Weight: 86 lbs **Cube:** 51.57

Standard Pillows: (1) 18 x 18 **Finish Req:** N
Standard Cushions: Ultra Plush **Standard Finish:** Traditional
COM: 14.75 yards **COL:** N/A
Standard with small nails around the inside arm. This style is not intended to be used as a stand-alone item, it has been designed to connect with other matching sectional components.

D	E	F	G	H	J	K COM	L	M	N	O	P	Q	R	S	T	U	(# above U) *	S Nail	M Nail
2985	3027	3069	3111	3153	3195	3237	3279	3321	3363	3405	3447	3489	3531	3573	3615	3657	42 (Riser) + 3657 (U)	Std.	N/A
Leather 1		Leather 2		Leather 3		Leather 4		Leather 5		Leather 6		Leather 8		COL		S Nail		M Nail	
N/A		N/A		N/A		N/A		N/A		N/A		N/A		N/A		N/A		N/A	

Fabric SKU: **2975-29** Leather SKU: **N/A**
KELLY

Kelly Skirted Corner Chair

Two Boxed Backs over One Seat
Width: 38.5 **Depth:** 38.5 **Height:** 41
AH: 0 **SH:** 21.5 **SD:** 21.5 **IW:** 21.5
Weight: 78 lbs **Cube:** 35.16

Standard Pillows: (2) 18 x 18 **Finish Req:** N
Standard Cushions: Ultra Plush **Standard Finish:** Traditional
COM: 12.5 yards **COL:** N/A

D	E	F	G	H	J	K COM	L	M	N	O	P	Q	R	S	T	U	(# above U) *	S Nail	M Nail
2625	2661	2697	2733	2769	2805	2841	2877	2913	2949	2985	3021	3057	3093	3129	3165	3201	36 (Riser) + 3201 (U)	N/A	N/A
Leather 1		Leather 2		Leather 3		Leather 4		Leather 5		Leather 6		Leather 8		COL		S Nail		M Nail	
N/A		N/A		N/A		N/A		N/A		N/A		N/A		N/A		N/A		N/A	

Upholstery

**Pillows are not available on leather SKUs*

Fabric SKU: **2975-31** Leather SKU: **N/A**

KELLY

Kelly Skirted Swivel Chair

Boxed Back

Width: 29 **Depth:** 38.5 **Height:** 41

AH: 25 **SH:** 21.5 **SD:** 21.5 **IW:** 22

Weight: 61 lbs **Cube:** 41.32

Standard Pillows: N/A **Finish Req:** N

Standard Cushions: Ultra Plush **Standard Finish:**

COM: 9 yards **COL:** N/A

Standard with small nails around the inside arm

D	E	F	G	H	J	K COM	L	M	N	O	P	Q	R	S	T	U	(# above U) *	S Nail	M Nail
2325	2349	2373	2397	2421	2445	2469	2493	2517	2541	2565	2589	2613	2637	2661	2685	2709	24 (Riser) + 2709 (U)	Std.	N/A
Leather 1		Leather 2		Leather 3		Leather 4		Leather 5		Leather 6		Leather 8		COL		S Nail		M Nail	
N/A		N/A		N/A		N/A		N/A		N/A		N/A		N/A		N/A		N/A	

Fabric SKU: **2975-32** Leather SKU: **N/A**

KELLY

Kelly Skirted Swivel Glider

Boxed Back

Width: 29 **Depth:** 38.5 **Height:** 41

AH: 25 **SH:** 21.5 **SD:** 21.5 **IW:** 22

Weight: 61 lbs **Cube:** 41.32

Standard Pillows: N/A **Finish Req:** N

Standard Cushions: Ultra Plush **Standard Finish:**

COM: 9 yards **COL:** N/A

D	E	F	G	H	J	K COM	L	M	N	O	P	Q	R	S	T	U	(# above U) *	S Nail	M Nail
2475	2499	2523	2547	2571	2595	2619	2643	2667	2691	2715	2739	2763	2787	2811	2835	2859	24 (Riser) + 2859 (U)	Std.	N/A
Leather 1		Leather 2		Leather 3		Leather 4		Leather 5		Leather 6		Leather 8		COL		S Nail		M Nail	
N/A		N/A		N/A		N/A		N/A		N/A		N/A		N/A		N/A		N/A	

Fabric SKU: **2975-50** Leather SKU: **N/A**

KELLY

Kelly Skirted Sofa

Three Boxed Backs over One Seat

Width: 93 **Depth:** 38.5 **Height:** 41

AH: 25 **SH:** 21.5 **SD:** 21.5 **IW:** 86.5

Weight: 143 lbs **Cube:** 102.13

Standard Pillows: (2) 18 x 18 **Finish Req:** N

Standard Cushions: Ultra Plush **Standard Finish:** Traditional

COM: 21.75 yards **COL:** N/A

Standard with small nails around the inside arm

D	E	F	G	H	J	K COM	L	M	N	O	P	Q	R	S	T	U	(# above U) *	S Nail	M Nail
4275	4341	4407	4473	4539	4605	4671	4737	4803	4869	4935	5001	5067	5133	5199	5265	5331	66 (Riser) + 5331 (U)	Std.	N/A
Leather 1		Leather 2		Leather 3		Leather 4		Leather 5		Leather 6		Leather 8		COL		S Nail		M Nail	
N/A		N/A		N/A		N/A		N/A		N/A		N/A		N/A		N/A		N/A	

Fabric SKU: **2975-51** Leather SKU: **N/A**

KELLY

Kelly Skirted Right Arm Sofa

Three Boxed Backs over One Seat

Width: 89 **Depth:** 38.5 **Height:** 41

AH: 25 **SH:** 21.5 **SD:** 21.5 **IW:** 86

Weight: 133 lbs **Cube:** 81.3

Standard Pillows: (2) 18 x 18 **Finish Req:** N

Standard Cushions: Ultra Plush **Standard Finish:** Traditional

COM: 20.5 yards **COL:** N/A

Standard with small nails around the inside arm. This style is not intended to be used as a stand-alone item, it has been designed to connect with other matching sectional components.

D	E	F	G	H	J	K COM	L	M	N	O	P	Q	R	S	T	U	(# above U) *	S Nail	M Nail
4125	4182	4239	4296	4353	4410	4467	4524	4581	4638	4695	4752	4809	4866	4923	4980	5037	57 (Riser) + 5037 (U)	Std.	N/A
Leather 1		Leather 2		Leather 3		Leather 4		Leather 5		Leather 6		Leather 8		COL		S Nail		M Nail	
N/A		N/A		N/A		N/A		N/A		N/A		N/A		N/A		N/A		N/A	

Fabric SKU: **2975-52** Leather SKU: **N/A**

KELLY

Kelly Skirted Left Arm Sofa

Three Boxed Backs over One Seat

Width: 89 **Depth:** 38.5 **Height:** 41

AH: 25 **SH:** 21.5 **SD:** 21.5 **IW:** 86

Weight: 133 lbs **Cube:** 81.3

Standard Pillows: (2) 18 x 18 **Finish Req:** N

Standard Cushions: Ultra Plush **Standard Finish:** Traditional

COM: 20.5 yards **COL:** N/A

Standard with small nails around the inside arm. This style is not intended to be used as a stand-alone item, it has been designed to connect with other matching sectional components.

D	E	F	G	H	J	K COM	L	M	N	O	P	Q	R	S	T	U	(# above U) *	S Nail	M Nail
4125	4182	4239	4296	4353	4410	4467	4524	4581	4638	4695	4752	4809	4866	4923	4980	5037	57 (Riser) + 5037 (U)	Std.	N/A
Leather 1		Leather 2		Leather 3		Leather 4		Leather 5		Leather 6		Leather 8		COL		S Nail		M Nail	
N/A		N/A		N/A		N/A		N/A		N/A		N/A		N/A		N/A		N/A	

Fabric SKU: **2975-53** Leather SKU: **N/A**

KELLY

Kelly Skirted Right Arm Corner Sofa

Four Boxed Backs over One Seat

Width: 99 **Depth:** 38.5 **Height:** 41

AH: 25 **SH:** 21.5 **SD:** 21.5 **IW:** 79

Weight: 162 lbs **Cube:** 90.43

Standard Pillows: (2) 18 x 18 **Finish Req:** N

Standard Cushions: Ultra Plush **Standard Finish:** Traditional

COM: 23 yards **COL:** N/A

Standard with small nails around the inside arm

D	E	F	G	H	J	K COM	L	M	N	O	P	Q	R	S	T	U	(# above U) *	S Nail	M Nail
4650	4713	4776	4839	4902	4965	5028	5091	5154	5217	5280	5343	5406	5469	5532	5595	5658	63 (Riser) + 5658 (U)	Std.	N/A
Leather 1		Leather 2		Leather 3		Leather 4		Leather 5		Leather 6		Leather 8		COL		S Nail		M Nail	
N/A		N/A		N/A		N/A		N/A		N/A		N/A		N/A		N/A		N/A	

Upholstery

**Pillows are not available on leather SKUs*

Fabric SKU: **2975-54** Leather SKU: **N/A**

KELLY

Kelly Skirted Left Arm Corner Sofa

Four Boxed Backs over One Seat

Width: 99 **Depth:** 38.5 **Height:** 41

AH: 25 **SH:** 21.5 **SD:** 21.5 **IW:** 79

Weight: 162 lbs **Cube:** 90.43

Standard Pillows: (2) 18 x 18 **Finish Req:** N

Standard Cushions: Ultra Plush **Standard Finish:** Traditional

COM: 23 yards **COL:** N/A

Standard with small nails around the inside arm

D	E	F	G	H	J	K COM	L	M	N	O	P	Q	R	S	T	U	(# above U) *	S Nail	M Nail
4650	4713	4776	4839	4902	4965	5028	5091	5154	5217	5280	5343	5406	5469	5532	5595	5658	63 (Riser) + 5658 (U)	Std.	N/A
Leather 1 N/A		Leather 2 N/A		Leather 3 N/A		Leather 4 N/A		Leather 5 N/A		Leather 6 N/A		Leather 8 N/A		COL N/A		S Nail N/A		M Nail N/A	

Fabric SKU: **2975-71** Leather SKU: **N/A**

KELLY

Kelly Skirted Right Arm Loveseat

Two Boxed Backs over One Seat

Width: 61.25 **Depth:** 38.5 **Height:** 41

AH: 25 **SH:** 21.5 **SD:** 21.5 **IW:** 58.25

Weight: 101 lbs **Cube:** 55.95

Standard Pillows: (2) 18 x 18 **Finish Req:** N

Standard Cushions: Ultra Plush **Standard Finish:** Traditional

COM: 16.5 yards **COL:** N/A

Standard with small nails around the inside arm. This style is not intended to be used as a stand-alone item, it has been designed to connect with other matching sectional components.

D	E	F	G	H	J	K COM	L	M	N	O	P	Q	R	S	T	U	(# above U) *	S Nail	M Nail
3300	3348	3396	3444	3492	3540	3588	3636	3684	3732	3780	3828	3876	3924	3972	4020	4068	48 (Riser) + 4068 (U)	Std.	N/A
Leather 1 N/A		Leather 2 N/A		Leather 3 N/A		Leather 4 N/A		Leather 5 N/A		Leather 6 N/A		Leather 8 N/A		COL N/A		S Nail N/A		M Nail N/A	

Fabric SKU: **2975-72** Leather SKU: **N/A**

KELLY

Kelly Skirted Left Arm Loveseat

Two Boxed Backs over One Seat

Width: 61.25 **Depth:** 38.5 **Height:** 41

AH: 25 **SH:** 21.5 **SD:** 21.5 **IW:** 58.25

Weight: 101 lbs **Cube:** 55.95

Standard Pillows: (2) 18 x 18 **Finish Req:** N

Standard Cushions: Ultra Plush **Standard Finish:** Traditional

COM: 16.5 yards **COL:** N/A

Standard with small nails around the inside arm. This style is not intended to be used as a stand-alone item, it has been designed to connect with other matching sectional components.

D	E	F	G	H	J	K COM	L	M	N	O	P	Q	R	S	T	U	(# above U) *	S Nail	M Nail
3300	3348	3396	3444	3492	3540	3588	3636	3684	3732	3780	3828	3876	3924	3972	4020	4068	48 (Riser) + 4068 (U)	Std.	N/A
Leather 1 N/A		Leather 2 N/A		Leather 3 N/A		Leather 4 N/A		Leather 5 N/A		Leather 6 N/A		Leather 8 N/A		COL N/A		S Nail N/A		M Nail N/A	

Fabric SKU: **2975-78** Leather SKU: **N/A**

KELLY

Kelly Skirted Armless Sectional Chair

One Boxed Back over One Seat

Width: 28 **Depth:** 38.5 **Height:** 41

AH: 0 **SH:** 21.5 **SD:** 21.5 **IW:** 27.75

Weight: 30 lbs **Cube:** 25.57

Standard Pillows: N/A **Finish Req:** N

Standard Cushions: Ultra Plush **Standard Finish:** Traditional

COM: 9.75 yards **COL:** N/A

This style is not intended to be used as a stand-alone item, it has been designed to connect with other matching sectional components.

D	E	F	G	H	J	K COM	L	M	N	O	P	Q	R	S	T	U	(# above U) *	S Nail	M Nail
1950	1977	2004	2031	2058	2085	2112	2139	2166	2193	2220	2247	2274	2301	2328	2355	2382	27 (Riser) + 2382 (U)	N/A	N/A
Leather 1 N/A		Leather 2 N/A		Leather 3 N/A		Leather 4 N/A		Leather 5 N/A		Leather 6 N/A		Leather 8 N/A		COL N/A		S Nail N/A		M Nail N/A	

Fabric SKU: **2976-01** Leather SKU: **N/A**

KELLY

Kelly Lounge Chair with Tapered Leg

Boxed Back

Width: 29 **Depth:** 38.5 **Height:** 41

AH: 25 **SH:** 21.5 **SD:** 21.5 **IW:** 22

Weight: 61 lbs **Cube:** 41.32

Standard Pillows: N/A **Finish Req:** Y

Standard Cushions: Ultra Plush **Standard Finish:**

COM: 7.25 yards **COL:** N/A

Standard with small nails around the inside arm

D	E	F	G	H	J	K COM	L	M	N	O	P	Q	R	S	T	U	(# above U) *	S Nail	M Nail
2250	2271	2292	2313	2334	2355	2376	2397	2418	2439	2460	2481	2502	2523	2544	2565	2586	21 (Riser) + 2586 (U)	Std.	N/A
Leather 1 N/A		Leather 2 N/A		Leather 3 N/A		Leather 4 N/A		Leather 5 N/A		Leather 6 N/A		Leather 8 N/A		COL N/A		S Nail N/A		M Nail N/A	

Fabric SKU: **2976-26** Leather SKU: **N/A**

KELLY

Kelly Right Arm Chaise with Tapered Leg

One Boxed Back over One Seat

Width: 31.5 **Depth:** 69 **Height:** 41

AH: 25 **SH:** 21.5 **SD:** 50 **IW:** 31

Weight: 86 lbs **Cube:** 51.57

Standard Pillows: (1) 18 x 18 **Finish Req:** Y

Standard Cushions: Ultra Plush **Standard Finish:**

COM: 12.25 yards **COL:** N/A

Standard with small nails around the inside arm. This style is not intended to be used as a stand-alone item, it has been designed to connect with other matching sectional components.

D	E	F	G	H	J	K COM	L	M	N	O	P	Q	R	S	T	U	(# above U) *	S Nail	M Nail
2985	3018	3051	3084	3117	3150	3183	3216	3249	3282	3315	3348	3381	3414	3447	3480	3513	33 (Riser) + 3513 (U)	Std.	N/A
Leather 1 N/A		Leather 2 N/A		Leather 3 N/A		Leather 4 N/A		Leather 5 N/A		Leather 6 N/A		Leather 8 N/A		COL N/A		S Nail N/A		M Nail N/A	

Upholstery

**Pillows are not available on leather SKUs*

Fabric SKU: **2976-27** Leather SKU: **N/A**

KELLY

Kelly Left Arm Chaise with Tapered Leg

One Boxed Back over One Seat

Width: 31.5 **Depth:** 69 **Height:** 41

AH: 25 **SH:** 21.5 **SD:** 50 **IW:** 31

Weight: 86 lbs **Cube:** 51.57

Standard Pillows: (1) 18 x 18 **Finish Req:** Y

Standard Cushions: Ultra Plush **Standard Finish:**

COM: 12.25 yards **COL:** N/A

Standard with small nails around the inside arm. This style is not intended to be used as a stand-alone item, it has been designed to connect with other matching sectional components.

D	E	F	G	H	J	K COM	L	M	N	O	P	Q	R	S	T	U	(# above U) *	S Nail	M Nail
2985	3018	3051	3084	3117	3150	3183	3216	3249	3282	3315	3348	3381	3414	3447	3480	3513	33 (Riser) + 3513 (U)	Std.	N/A
Leather 1		Leather 2		Leather 3		Leather 4		Leather 5		Leather 6		Leather 8		COL		S Nail		M Nail	
N/A		N/A		N/A		N/A		N/A		N/A		N/A		N/A		N/A		N/A	

Fabric SKU: **2976-29** Leather SKU: **N/A**

KELLY

Kelly Corner Chair with Tapered Leg

Two Boxed Backs over One Seat

Width: 38.5 **Depth:** 38.5 **Height:** 41

AH: 0 **SH:** 21.5 **SD:** 21.5 **IW:** 21.5

Weight: 78 lbs **Cube:** 35.16

Standard Pillows: (2) 18 x 18 **Finish Req:** Y

Standard Cushions: Ultra Plush **Standard Finish:**

COM: 11.75 yards **COL:** N/A

Standard with small nails around the inside arm

D	E	F	G	H	J	K COM	L	M	N	O	P	Q	R	S	T	U	(# above U) *	S Nail	M Nail
2625	2658	2691	2724	2757	2790	2823	2856	2889	2922	2955	2988	3021	3054	3087	3120	3153	33 (Riser) + 3153 (U)	N/A	N/A
Leather 1		Leather 2		Leather 3		Leather 4		Leather 5		Leather 6		Leather 8		COL		S Nail		M Nail	
N/A		N/A		N/A		N/A		N/A		N/A		N/A		N/A		N/A		N/A	

Fabric SKU: **2976-50** Leather SKU: **N/A**

KELLY

Kelly Sofa with Tapered Leg

Three Boxed Backs over One Seat

Width: 93 **Depth:** 38.5 **Height:** 41

AH: 25 **SH:** 21.5 **SD:** 21.5 **IW:** 86.5

Weight: 143 lbs **Cube:** 102.13

Standard Pillows: (2) 18 x 18 **Finish Req:** Y

Standard Cushions: Ultra Plush **Standard Finish:**

COM: 19.25 yards **COL:** N/A

Standard with small nails around the inside arm

D	E	F	G	H	J	K COM	L	M	N	O	P	Q	R	S	T	U	(# above U) *	S Nail	M Nail
4275	4335	4395	4455	4515	4575	4635	4695	4755	4815	4875	4935	4995	5055	5115	5175	5235	60 (Riser) + 5235 (U)	Std.	N/A
Leather 1		Leather 2		Leather 3		Leather 4		Leather 5		Leather 6		Leather 8		COL		S Nail		M Nail	
N/A		N/A		N/A		N/A		N/A		N/A		N/A		N/A		N/A		N/A	

Fabric SKU: **2976-51** Leather SKU: **N/A**

KELLY

Kelly Right Arm Sofa with Tapered Leg

Three Boxed Backs over One Seat

Width: 89 **Depth:** 38.5 **Height:** 41

AH: 25 **SH:** 21.5 **SD:** 21.5 **IW:** 86

Weight: 133 lbs **Cube:** 81.3

Standard Pillows: (2) 18 x 18 **Finish Req:** Y

Standard Cushions: Ultra Plush **Standard Finish:**

COM: 17 yards **COL:** N/A

Standard with small nails around the inside arm. This style is not intended to be used as a stand-alone item, it has been designed to connect with other matching sectional components.

D	E	F	G	H	J	K COM	L	M	N	O	P	Q	R	S	T	U	(# above U) *	S Nail	M Nail
4125	4173	4221	4269	4317	4365	4413	4461	4509	4557	4605	4653	4701	4749	4797	4845	4893	48 (Riser) + 4893 (U)	Std.	N/A
Leather 1		Leather 2		Leather 3		Leather 4		Leather 5		Leather 6		Leather 8		COL		S Nail		M Nail	
N/A		N/A		N/A		N/A		N/A		N/A		N/A		N/A		N/A		N/A	

Fabric SKU: **2976-52** Leather SKU: **N/A**

KELLY

Kelly Left Arm Sofa with Tapered Leg

Three Boxed Backs over One Seat

Width: 89 **Depth:** 38.5 **Height:** 41

AH: 25 **SH:** 21.5 **SD:** 21.5 **IW:** 86

Weight: 133 lbs **Cube:** 81.3

Standard Pillows: (2) 18 x 18 **Finish Req:** Y

Standard Cushions: Ultra Plush **Standard Finish:**

COM: 17 yards **COL:** N/A

Standard with small nails around the inside arm. This style is not intended to be used as a stand-alone item, it has been designed to connect with other matching sectional components.

D	E	F	G	H	J	K COM	L	M	N	O	P	Q	R	S	T	U	(# above U) *	S Nail	M Nail
4125	4173	4221	4269	4317	4365	4413	4461	4509	4557	4605	4653	4701	4749	4797	4845	4893	48 (Riser) + 4893 (U)	Std.	N/A
Leather 1		Leather 2		Leather 3		Leather 4		Leather 5		Leather 6		Leather 8		COL		S Nail		M Nail	
N/A		N/A		N/A		N/A		N/A		N/A		N/A		N/A		N/A		N/A	

Fabric SKU: **2976-53** Leather SKU: **N/A**

KELLY

Kelly Right Arm Corner Sofa with Tapered Leg

Four Boxed Backs over One Seat

Width: 99 **Depth:** 38.5 **Height:** 41

AH: 25 **SH:** 21.5 **SD:** 21.5 **IW:** 79

Weight: 162 lbs **Cube:** 90.43

Standard Pillows: (2) 18 x 18 **Finish Req:** Y

Standard Cushions: Ultra Plush **Standard Finish:**

COM: 20.75 yards **COL:** N/A

Standard with small nails around the inside arm

D	E	F	G	H	J	K COM	L	M	N	O	P	Q	R	S	T	U	(# above U) *	S Nail	M Nail
4650	4710	4770	4830	4890	4950	5010	5070	5130	5190	5250	5310	5370	5430	5490	5550	5610	60 (Riser) + 5610 (U)	Std.	N/A
Leather 1		Leather 2		Leather 3		Leather 4		Leather 5		Leather 6		Leather 8		COL		S Nail		M Nail	
N/A		N/A		N/A		N/A		N/A		N/A		N/A		N/A		N/A		N/A	

Upholstery

**Pillows are not available on leather SKUs*

Fabric SKU: **2976-54** Leather SKU: **N/A**

KELLY

Kelly Left Arm Corner Sofa with Tapered Leg

Four Boxed Backs over One Seat

Width: 99 **Depth:** 38.5 **Height:** 41

AH: 25 **SH:** 21.5 **SD:** 21.5 **IW:** 79

Weight: 162 lbs **Cube:** 90.43

Standard Pillows: (2) 18 x 18 **Finish Req:** Y

Standard Cushions: Ultra Plush **Standard Finish:**

COM: 20.75 yards **COL:** N/A

Standard with small nails around the inside arm

D	E	F	G	H	J	K COM	L	M	N	O	P	Q	R	S	T	U	(# above U) *	S Nail	M Nail
4650	4710	4770	4830	4890	4950	5010	5070	5130	5190	5250	5310	5370	5430	5490	5550	5610	60 (Riser) + 5610 (U)	Std.	N/A
Leather 1 N/A		Leather 2 N/A		Leather 3 N/A		Leather 4 N/A		Leather 5 N/A		Leather 6 N/A		Leather 8 N/A		COL N/A		S Nail N/A		M Nail N/A	

Fabric SKU: **2976-71** Leather SKU: **N/A**

KELLY

Kelly Right Arm Loveseat with Tapered Leg

Two Boxed Backs over One Seat

Width: 61.25 **Depth:** 38.5 **Height:** 41

AH: 25 **SH:** 21.5 **SD:** 21.5 **IW:** 58.25

Weight: 101 lbs **Cube:** 55.95

Standard Pillows: (2) 18 x 18 **Finish Req:** Y

Standard Cushions: Ultra Plush **Standard Finish:**

COM: 15 yards **COL:** N/A

Standard with small nails around the inside arm. This style is not intended to be used as a stand-alone item, it has been designed to connect with other matching sectional components.

D	E	F	G	H	J	K COM	L	M	N	O	P	Q	R	S	T	U	(# above U) *	S Nail	M Nail
3300	3342	3384	3426	3468	3510	3552	3594	3636	3678	3720	3762	3804	3846	3888	3930	3972	42 (Riser) + 3972 (U)	Std.	N/A
Leather 1 N/A		Leather 2 N/A		Leather 3 N/A		Leather 4 N/A		Leather 5 N/A		Leather 6 N/A		Leather 8 N/A		COL N/A		S Nail N/A		M Nail N/A	

Fabric SKU: **2976-72** Leather SKU: **N/A**

KELLY

Kelly Left Arm Loveseat with Tapered Leg

Two Boxed Backs over One Seat

Width: 61.25 **Depth:** 38.5 **Height:** 41

AH: 25 **SH:** 21.5 **SD:** 21.5 **IW:** 58.25

Weight: 101 lbs **Cube:** 55.95

Standard Pillows: (2) 18 x 18 **Finish Req:** Y

Standard Cushions: Ultra Plush **Standard Finish:**

COM: 15 yards **COL:** N/A

Standard with small nails around the inside arm. This style is not intended to be used as a stand-alone item, it has been designed to connect with other matching sectional components.

D	E	F	G	H	J	K COM	L	M	N	O	P	Q	R	S	T	U	(# above U) *	S Nail	M Nail
3300	3342	3384	3426	3468	3510	3552	3594	3636	3678	3720	3762	3804	3846	3888	3930	3972	42 (Riser) + 3972 (U)	Std.	N/A
Leather 1 N/A		Leather 2 N/A		Leather 3 N/A		Leather 4 N/A		Leather 5 N/A		Leather 6 N/A		Leather 8 N/A		COL N/A		S Nail N/A		M Nail N/A	

Fabric SKU: **2976-78** Leather SKU: **N/A**

KELLY

Kelly Armless Sectional Chair with Tapered Leg

One Boxed Back over One Seat

Width: 28 **Depth:** 38.5 **Height:** 41

AH: 0 **SH:** 21.5 **SD:** 21.5 **IW:** 27.75

Weight: 30 lbs **Cube:** 25.57

Standard Pillows: N/A **Finish Req:** Y

Standard Cushions: Ultra Plush **Standard Finish:**

COM: 8.75 yards **COL:** N/A

This style is not intended to be used as a stand-alone item, it has been designed to connect with other matching sectional components.

D	E	F	G	H	J	K COM	L	M	N	O	P	Q	R	S	T	U	(# above U) *	S Nail	M Nail
1950	1974	1998	2022	2046	2070	2094	2118	2142	2166	2190	2214	2238	2262	2286	2310	2334	24 (Riser) + 2334 (U)	N/A	N/A
Leather 1 N/A		Leather 2 N/A		Leather 3 N/A		Leather 4 N/A		Leather 5 N/A		Leather 6 N/A		Leather 8 N/A		COL N/A		S Nail N/A		M Nail N/A	

Fabric SKU: **2983-50** Leather SKU: **N/A**

KELLY

Kelly Skirted Sofa

Two Knife-edge Backs over Two Seats

Width: 83 **Depth:** 38.5 **Height:** 41

AH: 25 **SH:** 21.5 **SD:** 21.5 **IW:** 76.5

Weight: 125 lbs **Cube:** 79.34

Standard Pillows: (2) 18 x 18 **Finish Req:** N

Standard Cushions: Ultra Plush **Standard Finish:** Traditional

COM: 21.5 yards **COL:** N/A

D	E	F	G	H	J	K COM	L	M	N	O	P	Q	R	S	T	U	(# above U) *	S Nail	M Nail
4425	4485	4545	4605	4665	4725	4785	4845	4905	4965	5025	5085	5145	5205	5265	5325	5385	60 (Riser) + 5385 (U)	Std.	N/A
Leather 1 N/A		Leather 2 N/A		Leather 3 N/A		Leather 4 N/A		Leather 5 N/A		Leather 6 N/A		Leather 8 N/A		COL N/A		S Nail N/A		M Nail N/A	

Fabric SKU: **2984-50** Leather SKU: **N/A**

KELLY

Kelly Sofa with Tapered Leg

Two Knife-edge Backs over Two Seats

Width: 83 **Depth:** 38.5 **Height:** 41

AH: 25 **SH:** 21.5 **SD:** 21.5 **IW:** 76.5

Weight: 125 lbs **Cube:** 87.69

Standard Pillows: (2) 18 x 18 **Finish Req:** Y

Standard Cushions: Ultra Plush **Standard Finish:**

COM: 18.75 yards **COL:** N/A

Standard with small nails around the inside arm

D	E	F	G	H	J	K COM	L	M	N	O	P	Q	R	S	T	U	(# above U) *	S Nail	M Nail
4425	4479	4533	4587	4641	4695	4749	4803	4857	4911	4965	5019	5073	5127	5181	5235	5289	54 (Riser) + 5289 (U)	Std.	N/A
Leather 1 N/A		Leather 2 N/A		Leather 3 N/A		Leather 4 N/A		Leather 5 N/A		Leather 6 N/A		Leather 8 N/A		COL N/A		S Nail N/A		M Nail N/A	

Upholstery

**Pillows are not available on leather SKUs*

Fabric SKU: **2985-50** Leather SKU: **N/A**

KELLY

Kelly Skirted Sofa

Two Boxed Backs over Two Seats

Width: 83 **Depth:** 38.5 **Height:** 41

AH: 25 **SH:** 21.5 **SD:** 21.5 **IW:** 76.5

Weight: 125 lbs **Cube:** 87.69

Standard Pillows: (2) 18 x 18 **Finish Req:** N

Standard Cushions: Ultra Plush **Standard Finish:**

COM: 22 yards **COL:** N/A

Standard with small nails around the inside arm

D	E	F	G	H	J	K COM	L	M	N	O	P	Q	R	S	T	U	(# above U) *	S Nail	M Nail
4425	4485	4545	4605	4665	4725	4785	4845	4905	4965	5025	5085	5145	5205	5265	5325	5385	60 (Riser) + 5385 (U)	Std.	N/A
Leather 1 N/A		Leather 2 N/A		Leather 3 N/A		Leather 4 N/A		Leather 5 N/A		Leather 6 N/A		Leather 8 N/A		COL N/A		S Nail N/A		M Nail N/A	

Fabric SKU: **2986-50** Leather SKU: **N/A**

KELLY

Kelly Sofa with Tapered Leg

Two Boxed Backs over Two Seats

Width: 83 **Depth:** 38.5 **Height:** 41

AH: 25 **SH:** 21.5 **SD:** 21.5 **IW:** 76.5

Weight: 125 lbs **Cube:** 87.69

Standard Pillows: (2) 18 x 18 **Finish Req:** Y

Standard Cushions: Ultra Plush **Standard Finish:**

COM: 19.25 yards **COL:** N/A

Standard with small nails around the inside arm

D	E	F	G	H	J	K COM	L	M	N	O	P	Q	R	S	T	U	(# above U) *	S Nail	M Nail
4425	4479	4533	4587	4641	4695	4749	4803	4857	4911	4965	5019	5073	5127	5181	5235	5289	54 (Riser) + 5289 (U)	Std.	N/A
Leather 1 N/A		Leather 2 N/A		Leather 3 N/A		Leather 4 N/A		Leather 5 N/A		Leather 6 N/A		Leather 8 N/A		COL N/A		S Nail N/A		M Nail N/A	

Fabric SKU: **2993-26** Leather SKU: **N/A**

KELLY

Kelly Skirted Right Arm Chaise

One Knife-edge Back over One Seat

Width: 31.5 **Depth:** 69 **Height:** 41

AH: 25 **SH:** 21.5 **SD:** 50 **IW:** 31

Weight: 86 lbs **Cube:** 51.57

Standard Pillows: (1) 18 x 18 **Finish Req:** N

Standard Cushions: Ultra Plush **Standard Finish:** Traditional

COM: 12.75 yards **COL:** N/A

Standard with small nails around the inside arm. This style is not intended to be used as a stand-alone item, it has been designed to connect with other matching sectional components.

D	E	F	G	H	J	K COM	L	M	N	O	P	Q	R	S	T	U	(# above U) *	S Nail	M Nail
2985	3021	3057	3093	3129	3165	3201	3237	3273	3309	3345	3381	3417	3453	3489	3525	3561	36 (Riser) + 3561 (U)	Std.	N/A
Leather 1 N/A		Leather 2 N/A		Leather 3 N/A		Leather 4 N/A		Leather 5 N/A		Leather 6 N/A		Leather 8 N/A		COL N/A		S Nail N/A		M Nail N/A	

Fabric SKU: **2993-27** Leather SKU: **N/A**

KELLY

Kelly Skirted Left Arm Chaise

One Knife-edge Back over One Seat

Width: 31.5 **Depth:** 69 **Height:** 41

AH: 25 **SH:** 21.5 **SD:** 50 **IW:** 31

Weight: 86 lbs **Cube:** 51.57

Standard Pillows: (1) 18 x 18 **Finish Req:** N

Standard Cushions: Ultra Plush **Standard Finish:** Traditional

COM: 12.75 yards **COL:** N/A

Standard with small nails around the inside arm. This style is not intended to be used as a stand-alone item, it has been designed to connect with other matching sectional components.

D	E	F	G	H	J	K COM	L	M	N	O	P	Q	R	S	T	U	(# above U) *	S Nail	M Nail
2985	3021	3057	3093	3129	3165	3201	3237	3273	3309	3345	3381	3417	3453	3489	3525	3561	36 (Riser) + 3561 (U)	Std.	N/A
Leather 1 N/A		Leather 2 N/A		Leather 3 N/A		Leather 4 N/A		Leather 5 N/A		Leather 6 N/A		Leather 8 N/A		COL N/A		S Nail N/A		M Nail N/A	

Fabric SKU: **2993-29** Leather SKU: **N/A**

KELLY

Kelly Skirted Corner Chair

Two Knife-edge Backs over One Seat

Width: 38.5 **Depth:** 38.5 **Height:** 41

AH: 0 **SH:** 21.5 **SD:** 21.5 **IW:** 21.5

Weight: 78 lbs **Cube:** 35.16

Standard Pillows: (2) 18 x 18 **Finish Req:** N

Standard Cushions: Ultra Plush **Standard Finish:** Traditional

COM: 12.75 yards **COL:** N/A

Standard with small nails around the inside arm

D	E	F	G	H	J	K COM	L	M	N	O	P	Q	R	S	T	U	(# above U) *	S Nail	M Nail
2625	2661	2697	2733	2769	2805	2841	2877	2913	2949	2985	3021	3057	3093	3129	3165	3201	36 (Riser) + 3201 (U)	N/A	N/A
Leather 1 N/A		Leather 2 N/A		Leather 3 N/A		Leather 4 N/A		Leather 5 N/A		Leather 6 N/A		Leather 8 N/A		COL N/A		S Nail N/A		M Nail N/A	

Fabric SKU: **2993-50** Leather SKU: **N/A**

KELLY

Kelly Skirted Sofa

Three Knife-edge Backs over Three Seats

Width: 93 **Depth:** 38.5 **Height:** 41

AH: 25 **SH:** 21.5 **SD:** 21.5 **IW:** 86.5

Weight: 143 lbs **Cube:** 92.4

Standard Pillows: (2) 18 x 18 **Finish Req:** N

Standard Cushions: Ultra Plush **Standard Finish:** Traditional

COM: 23 yards **COL:** N/A

D	E	F	G	H	J	K COM	L	M	N	O	P	Q	R	S	T	U	(# above U) *	S Nail	M Nail
4425	4494	4563	4632	4701	4770	4839	4908	4977	5046	5115	5184	5253	5322	5391	5460	5529	69 (Riser) + 5529 (U)	Std.	N/A
Leather 1 N/A		Leather 2 N/A		Leather 3 N/A		Leather 4 N/A		Leather 5 N/A		Leather 6 N/A		Leather 8 N/A		COL N/A		S Nail N/A		M Nail N/A	

Upholstery

**Pillows are not available on leather SKUs*

Fabric SKU: **2993-51** Leather SKU: **N/A**
 KELLY

Kelly Skirted Right Arm Sofa
 Three Knife-edge Backs over Three Seats
Width: 89 **Depth:** 38.5 **Height:** 41
AH: 25 **SH:** 21.5 **SD:** 21.5 **IW:** 86
Weight: 133 lbs **Cube:** 81.3

Standard Pillows: (2) 18 x 18 **Finish Req:** N
Standard Cushions: Ultra Plush **Standard Finish:** Traditional
COM: 22 yards **COL:** N/A
 Standard with small nails around the inside arm. This style is not intended to be used as a stand-alone item, it has been designed to connect with other matching sectional components.

D	E	F	G	H	J	K COM	L	M	N	O	P	Q	R	S	T	U	(# above U) *	S Nail	M Nail
4125	4185	4245	4305	4365	4425	4485	4545	4605	4665	4725	4785	4845	4905	4965	5025	5085	60 (Riser) + 5085 (U)	S Nail Std.	M Nail N/A
Leather 1 N/A		Leather 2 N/A		Leather 3 N/A		Leather 4 N/A		Leather 5 N/A		Leather 6 N/A		Leather 8 N/A		COL N/A		S Nail N/A		M Nail N/A	

Fabric SKU: **2993-52** Leather SKU: **N/A**
 KELLY

Kelly Skirted Left Arm Sofa
 Three Knife-edge Backs over Three Seats
Width: 89 **Depth:** 38.5 **Height:** 41
AH: 25 **SH:** 21.5 **SD:** 21.5 **IW:** 86
Weight: 133 lbs **Cube:** 81.3

Standard Pillows: (2) 18 x 18 **Finish Req:** N
Standard Cushions: Ultra Plush **Standard Finish:** Traditional
COM: 22 yards **COL:** N/A
 Standard with small nails around the inside arm. This style is not intended to be used as a stand-alone item, it has been designed to connect with other matching sectional components.

D	E	F	G	H	J	K COM	L	M	N	O	P	Q	R	S	T	U	(# above U) *	S Nail	M Nail
4125	4185	4245	4305	4365	4425	4485	4545	4605	4665	4725	4785	4845	4905	4965	5025	5085	60 (Riser) + 5085 (U)	S Nail Std.	M Nail N/A
Leather 1 N/A		Leather 2 N/A		Leather 3 N/A		Leather 4 N/A		Leather 5 N/A		Leather 6 N/A		Leather 8 N/A		COL N/A		S Nail N/A		M Nail N/A	

Fabric SKU: **2993-53** Leather SKU: **N/A**
 KELLY

Kelly Skirted Right Arm Corner Sofa
 Four Knife-edge Backs over Three Seats
Width: 99 **Depth:** 38.5 **Height:** 41
AH: 25 **SH:** 21.5 **SD:** 21.5 **IW:** 79
Weight: 162 lbs **Cube:** 90.43

Standard Pillows: (2) 18 x 18 **Finish Req:** N
Standard Cushions: Ultra Plush **Standard Finish:** Traditional
COM: 25.75 yards **COL:** N/A
 Standard with small nails around the inside arm

D	E	F	G	H	J	K COM	L	M	N	O	P	Q	R	S	T	U	(# above U) *	S Nail	M Nail
4650	4722	4794	4866	4938	5010	5082	5154	5226	5298	5370	5442	5514	5586	5658	5730	5802	72 (Riser) + 5802 (U)	S Nail Std.	M Nail N/A
Leather 1 N/A		Leather 2 N/A		Leather 3 N/A		Leather 4 N/A		Leather 5 N/A		Leather 6 N/A		Leather 8 N/A		COL N/A		S Nail N/A		M Nail N/A	

Fabric SKU: **2993-54** Leather SKU: **N/A**
 KELLY

Kelly Skirted Left Arm Corner Sofa
 Four Knife-edge Backs over Three Seats
Width: 99 **Depth:** 38.5 **Height:** 41
AH: 25 **SH:** 21.5 **SD:** 21.5 **IW:** 79
Weight: 162 lbs **Cube:** 90.43

Standard Pillows: (2) 18 x 18 **Finish Req:** N
Standard Cushions: Ultra Plush **Standard Finish:** Traditional
COM: 25.75 yards **COL:** N/A
 Standard with small nails around the inside arm

D	E	F	G	H	J	K COM	L	M	N	O	P	Q	R	S	T	U	(# above U) *	S Nail	M Nail
4650	4722	4794	4866	4938	5010	5082	5154	5226	5298	5370	5442	5514	5586	5658	5730	5802	72 (Riser) + 5802 (U)	S Nail Std.	M Nail N/A
Leather 1 N/A		Leather 2 N/A		Leather 3 N/A		Leather 4 N/A		Leather 5 N/A		Leather 6 N/A		Leather 8 N/A		COL N/A		S Nail N/A		M Nail N/A	

Fabric SKU: **2993-71** Leather SKU: **N/A**
 KELLY

Kelly Skirted Right Arm Loveseat
 Two Knife-edge Backs over Two Seats
Width: 61.25 **Depth:** 38.5 **Height:** 41
AH: 25 **SH:** 21.5 **SD:** 21.5 **IW:** 58.25
Weight: 101 lbs **Cube:** 55.95

Standard Pillows: (2) 18 x 18 **Finish Req:** N
Standard Cushions: Ultra Plush **Standard Finish:** Traditional
COM: 18.25 yards **COL:** N/A
 Standard with small nails around the inside arm. This style is not intended to be used as a stand-alone item, it has been designed to connect with other matching sectional components.

D	E	F	G	H	J	K COM	L	M	N	O	P	Q	R	S	T	U	(# above U) *	S Nail	M Nail
3300	3351	3402	3453	3504	3555	3606	3657	3708	3759	3810	3861	3912	3963	4014	4065	4116	51 (Riser) + 4116 (U)	S Nail Std.	M Nail N/A
Leather 1 N/A		Leather 2 N/A		Leather 3 N/A		Leather 4 N/A		Leather 5 N/A		Leather 6 N/A		Leather 8 N/A		COL N/A		S Nail N/A		M Nail N/A	

Fabric SKU: **2993-72** Leather SKU: **N/A**
 KELLY

Kelly Skirted Left Arm Loveseat
 Two Knife-edge Backs over Two Seats
Width: 61.25 **Depth:** 38.5 **Height:** 41
AH: 25 **SH:** 21.5 **SD:** 21.5 **IW:** 58.25
Weight: 101 lbs **Cube:** 55.95

Standard Pillows: (2) 18 x 18 **Finish Req:** N
Standard Cushions: Ultra Plush **Standard Finish:** Traditional
COM: 18.25 yards **COL:** N/A
 Standard with small nails around the inside arm. This style is not intended to be used as a stand-alone item, it has been designed to connect with other matching sectional components.

D	E	F	G	H	J	K COM	L	M	N	O	P	Q	R	S	T	U	(# above U) *	S Nail	M Nail
3300	3351	3402	3453	3504	3555	3606	3657	3708	3759	3810	3861	3912	3963	4014	4065	4116	51 (Riser) + 4116 (U)	S Nail Std.	M Nail N/A
Leather 1 N/A		Leather 2 N/A		Leather 3 N/A		Leather 4 N/A		Leather 5 N/A		Leather 6 N/A		Leather 8 N/A		COL N/A		S Nail N/A		M Nail N/A	

Upholstery

**Pillows are not available on leather SKUs*

Fabric SKU: **2993-78** Leather SKU: **N/A**

KELLY

Kelly Skirted Armless Sectional Chair

One Knife-edge Back over One Seat

Width: 28 **Depth:** 38.5 **Height:** 41

AH: 0 **SH:** 21.5 **SD:** 21.5 **IW:** 27.75

Weight: 30 lbs **Cube:** 25.57

Standard Pillows: N/A **Finish Req:** N

Standard Cushions: Ultra Plush **Standard Finish:** Traditional

COM: 9.5 yards **COL:** N/A

This style is not intended to be used as a stand-alone item, it has been designed to connect with other matching sectional components.

D	E	F	G	H	J	K COM	L	M	N	O	P	Q	R	S	T	U	(# above U) *	S Nail	M Nail
1950	1977	2004	2031	2058	2085	2112	2139	2166	2193	2220	2247	2274	2301	2328	2355	2382	27 (Riser) + 2382 (U)	N/A	N/A
Leather 1 N/A		Leather 2 N/A		Leather 3 N/A		Leather 4 N/A		Leather 5 N/A		Leather 6 N/A		Leather 8 N/A		COL N/A		S Nail N/A		M Nail N/A	

Fabric SKU: **2994-26** Leather SKU: **N/A**

KELLY

Kelly Right Arm Chaise with Tapered Leg

One Knife-edge Back over Three Seats

Width: 31.5 **Depth:** 69 **Height:** 41

AH: 25 **SH:** 21.5 **SD:** 50 **IW:** 31

Weight: 86 lbs **Cube:** 51.57

Standard Pillows: (1) 18 x 18 **Finish Req:** Y

Standard Cushions: Ultra Plush **Standard Finish:**

COM: 12.25 yards **COL:** N/A

Standard with small nails around the inside arm. This style is not intended to be used as a stand-alone item, it has been designed to connect with other matching sectional components.

D	E	F	G	H	J	K COM	L	M	N	O	P	Q	R	S	T	U	(# above U) *	S Nail	M Nail
2985	3018	3051	3084	3117	3150	3183	3216	3249	3282	3315	3348	3381	3414	3447	3480	3513	33 (Riser) + 3513 (U)	Std.	N/A
Leather 1 N/A		Leather 2 N/A		Leather 3 N/A		Leather 4 N/A		Leather 5 N/A		Leather 6 N/A		Leather 8 N/A		COL N/A		S Nail N/A		M Nail N/A	

Fabric SKU: **2994-27** Leather SKU: **N/A**

KELLY

Kelly Left Arm Chaise with Tapered Leg

One Knife-edge Back over One Seat

Width: 31.5 **Depth:** 69 **Height:** 41

AH: 25 **SH:** 21.5 **SD:** 50 **IW:** 31

Weight: 86 lbs **Cube:** 51.57

Standard Pillows: (1) 18 x 18 **Finish Req:** Y

Standard Cushions: Ultra Plush **Standard Finish:**

COM: 12.25 yards **COL:** N/A

Standard with small nails around the inside arm. This style is not intended to be used as a stand-alone item, it has been designed to connect with other matching sectional components.

D	E	F	G	H	J	K COM	L	M	N	O	P	Q	R	S	T	U	(# above U) *	S Nail	M Nail
2985	3018	3051	3084	3117	3150	3183	3216	3249	3282	3315	3348	3381	3414	3447	3480	3513	33 (Riser) + 3513 (U)	Std.	N/A
Leather 1 N/A		Leather 2 N/A		Leather 3 N/A		Leather 4 N/A		Leather 5 N/A		Leather 6 N/A		Leather 8 N/A		COL N/A		S Nail N/A		M Nail N/A	

Fabric SKU: **2994-29** Leather SKU: **N/A**

KELLY

Kelly Corner Chair with Tapered Leg

Two Knife-edge Backs over One Seat

Width: 38.5 **Depth:** 38.5 **Height:** 41

AH: 0 **SH:** 21.5 **SD:** 21.5 **IW:** 21.5

Weight: 78 lbs **Cube:** 35.16

Standard Pillows: (2) 18 x 18 **Finish Req:** Y

Standard Cushions: Ultra Plush **Standard Finish:**

COM: 12 yards **COL:** N/A

Standard with small nails around the inside arm

D	E	F	G	H	J	K COM	L	M	N	O	P	Q	R	S	T	U	(# above U) *	S Nail	M Nail
2625	2658	2691	2724	2757	2790	2823	2856	2889	2922	2955	2988	3021	3054	3087	3120	3153	33 (Riser) + 3153 (U)	N/A	N/A
Leather 1 N/A		Leather 2 N/A		Leather 3 N/A		Leather 4 N/A		Leather 5 N/A		Leather 6 N/A		Leather 8 N/A		COL N/A		S Nail N/A		M Nail N/A	

Fabric SKU: **2994-50** Leather SKU: **N/A**

KELLY

Kelly Sofa with Tapered Leg

Three Knife-edge Backs over Three Seats

Width: 93 **Depth:** 38.5 **Height:** 41

AH: 25 **SH:** 21.5 **SD:** 21.5 **IW:** 86.5

Weight: 143 lbs **Cube:** 102.13

Standard Pillows: (2) 18 x 18 **Finish Req:** Y

Standard Cushions: Ultra Plush **Standard Finish:**

COM: 20 yards **COL:** N/A

Standard with small nails around the inside arm

D	E	F	G	H	J	K COM	L	M	N	O	P	Q	R	S	T	U	(# above U) *	S Nail	M Nail
4425	4485	4545	4605	4665	4725	4785	4845	4905	4965	5025	5085	5145	5205	5265	5325	5385	60 (Riser) + 5385 (U)	Std.	N/A
Leather 1 N/A		Leather 2 N/A		Leather 3 N/A		Leather 4 N/A		Leather 5 N/A		Leather 6 N/A		Leather 8 N/A		COL N/A		S Nail N/A		M Nail N/A	

Fabric SKU: **2994-51** Leather SKU: **N/A**

KELLY

Kelly Right Arm Sofa with Tapered Leg

Three Knife-edge Backs over Three Seats

Width: 89 **Depth:** 38.5 **Height:** 41

AH: 25 **SH:** 21.5 **SD:** 21.5 **IW:** 86

Weight: 133 lbs **Cube:** 81.3

Standard Pillows: (2) 18 x 18 **Finish Req:** Y

Standard Cushions: Ultra Plush **Standard Finish:**

COM: 19.25 yards **COL:** N/A

Standard with small nails around the inside arm. This style is not intended to be used as a stand-alone item, it has been designed to connect with other matching sectional components.

D	E	F	G	H	J	K COM	L	M	N	O	P	Q	R	S	T	U	(# above U) *	S Nail	M Nail
4125	4179	4233	4287	4341	4395	4449	4503	4557	4611	4665	4719	4773	4827	4881	4935	4989	54 (Riser) + 4989 (U)	Std.	N/A
Leather 1 N/A		Leather 2 N/A		Leather 3 N/A		Leather 4 N/A		Leather 5 N/A		Leather 6 N/A		Leather 8 N/A		COL N/A		S Nail N/A		M Nail N/A	

Upholstery

**Pillows are not available on leather SKUs*

Fabric SKU: **2994-52** Leather SKU: **N/A**
KELLY

Kelly Left Arm Sofa with Tapered Leg

Three Knife-edge Backs over Three Seats

Width: 89 **Depth:** 38.5 **Height:** 41

AH: 25 **SH:** 21.5 **SD:** 21.5 **IW:** 86

Weight: 133 lbs **Cube:** 81.3

Standard Pillows: (2) 18 x 18 **Finish Req:** Y

Standard Cushions: Ultra Plush **Standard Finish:**

COM: 19.25 yards **COL:** N/A

Standard with small nails around the inside arm. This style is not intended to be used as a stand-alone item, it has been designed to connect with other matching sectional components.

D	E	F	G	H	J	K COM	L	M	N	O	P	Q	R	S	T	U	(# above U) *	S Nail	M Nail
4125	4179	4233	4287	4341	4395	4449	4503	4557	4611	4665	4719	4773	4827	4881	4935	4989	54 (Riser) + 4989 (U)	Std.	N/A
Leather 1		Leather 2		Leather 3		Leather 4		Leather 5		Leather 6		Leather 8		COL		S Nail		M Nail	
N/A		N/A		N/A		N/A		N/A		N/A		N/A		N/A		N/A		N/A	

Fabric SKU: **2994-53** Leather SKU: **N/A**
KELLY

Kelly Right Arm Corner Sofa with Tapered Leg

Four Knife-edge Backs over Three Seats

Width: 99 **Depth:** 38.5 **Height:** 41

AH: 25 **SH:** 21.5 **SD:** 21.5 **IW:** 79

Weight: 162 lbs **Cube:** 90.43

Standard Pillows: (2) 18 x 18 **Finish Req:** Y

Standard Cushions: Ultra Plush **Standard Finish:**

COM: 22.75 yards **COL:** N/A

Standard with small nails around the inside arm

D	E	F	G	H	J	K COM	L	M	N	O	P	Q	R	S	T	U	(# above U) *	S Nail	M Nail
4650	4713	4776	4839	4902	4965	5028	5091	5154	5217	5280	5343	5406	5469	5532	5595	5658	63 (Riser) + 5658 (U)	Std.	N/A
Leather 1		Leather 2		Leather 3		Leather 4		Leather 5		Leather 6		Leather 8		COL		S Nail		M Nail	
N/A		N/A		N/A		N/A		N/A		N/A		N/A		N/A		N/A		N/A	

Fabric SKU: **2994-54** Leather SKU: **N/A**
KELLY

Kelly Left Arm Corner Sofa with Tapered Leg

Four Knife-edge Backs over Three Seats

Width: 99 **Depth:** 38.5 **Height:** 41

AH: 25 **SH:** 21.5 **SD:** 21.5 **IW:** 79

Weight: 162 lbs **Cube:** 90.43

Standard Pillows: (2) 18 x 18 **Finish Req:** Y

Standard Cushions: Ultra Plush **Standard Finish:**

COM: 22.75 yards **COL:** N/A

Standard with small nails around the inside arm

D	E	F	G	H	J	K COM	L	M	N	O	P	Q	R	S	T	U	(# above U) *	S Nail	M Nail
4650	4713	4776	4839	4902	4965	5028	5091	5154	5217	5280	5343	5406	5469	5532	5595	5658	63 (Riser) + 5658 (U)	Std.	N/A
Leather 1		Leather 2		Leather 3		Leather 4		Leather 5		Leather 6		Leather 8		COL		S Nail		M Nail	
N/A		N/A		N/A		N/A		N/A		N/A		N/A		N/A		N/A		N/A	

Fabric SKU: **2994-71** Leather SKU: **N/A**
KELLY

Kelly Right Arm Loveseat with Tapered Leg

Two Knife-edge Backs over Two Seats

Width: 61.25 **Depth:** 38.5 **Height:** 41

AH: 25 **SH:** 21.5 **SD:** 21.5 **IW:** 58.25

Weight: 101 lbs **Cube:** 55.95

Standard Pillows: (2) 18 x 18 **Finish Req:** Y

Standard Cushions: Ultra Plush **Standard Finish:**

COM: 16 yards **COL:** N/A

Standard with small nails around the inside arm. This style is not intended to be used as a stand-alone item, it has been designed to connect with other matching sectional components.

D	E	F	G	H	J	K COM	L	M	N	O	P	Q	R	S	T	U	(# above U) *	S Nail	M Nail
3300	3345	3390	3435	3480	3525	3570	3615	3660	3705	3750	3795	3840	3885	3930	3975	4020	45 (Riser) + 4020 (U)	Std.	N/A
Leather 1		Leather 2		Leather 3		Leather 4		Leather 5		Leather 6		Leather 8		COL		S Nail		M Nail	
N/A		N/A		N/A		N/A		N/A		N/A		N/A		N/A		N/A		N/A	

Fabric SKU: **2994-72** Leather SKU: **N/A**
KELLY

Kelly Left Arm Loveseat with Tapered Leg

Two Knife-edge Backs over Two Seats

Width: 61.25 **Depth:** 38.5 **Height:** 41

AH: 25 **SH:** 21.5 **SD:** 21.5 **IW:** 58.25

Weight: 101 lbs **Cube:** 55.95

Standard Pillows: (2) 18 x 18 **Finish Req:** Y

Standard Cushions: Ultra Plush **Standard Finish:**

COM: 16 yards **COL:** N/A

Standard with small nails around the inside arm. This style is not intended to be used as a stand-alone item, it has been designed to connect with other matching sectional components.

D	E	F	G	H	J	K COM	L	M	N	O	P	Q	R	S	T	U	(# above U) *	S Nail	M Nail
3300	3345	3390	3435	3480	3525	3570	3615	3660	3705	3750	3795	3840	3885	3930	3975	4020	45 (Riser) + 4020 (U)	Std.	N/A
Leather 1		Leather 2		Leather 3		Leather 4		Leather 5		Leather 6		Leather 8		COL		S Nail		M Nail	
N/A		N/A		N/A		N/A		N/A		N/A		N/A		N/A		N/A		N/A	

Fabric SKU: **2994-78** Leather SKU: **N/A**
KELLY

Kelly Armless Sectional Chair with Tapered Leg

One Knife-edge Back over One Seat

Width: 28 **Depth:** 38.5 **Height:** 41

AH: 0 **SH:** 21.5 **SD:** 21.5 **IW:** 27.75

Weight: 30 lbs **Cube:** 25.57

Standard Pillows: N/A **Finish Req:** Y

Standard Cushions: Ultra Plush **Standard Finish:**

COM: 8.75 yards **COL:** N/A

This style is not intended to be used as a stand-alone item, it has been designed to connect with other matching sectional components.

D	E	F	G	H	J	K COM	L	M	N	O	P	Q	R	S	T	U	(# above U) *	S Nail	M Nail
1950	1974	1998	2022	2046	2070	2094	2118	2142	2166	2190	2214	2238	2262	2286	2310	2334	24 (Riser) + 2334 (U)	N/A	N/A
Leather 1		Leather 2		Leather 3		Leather 4		Leather 5		Leather 6		Leather 8		COL		S Nail		M Nail	
N/A		N/A		N/A		N/A		N/A		N/A		N/A		N/A		N/A		N/A	

Upholstery

**Pillows are not available on leather SKUs*

Fabric SKU: **2995-26** Leather SKU: **N/A**
 KELLY

Kelly Skirted Right Arm Chaise

One Boxed Back over One Seat
Width: 31.5 **Depth:** 69 **Height:** 41
AH: 25 **SH:** 21.5 **SD:** 50 **IW:** 31
Weight: 86 lbs **Cube:** 51.57

Standard Pillows: (1) 18 x 18 **Finish Req:** N
Standard Cushions: Ultra Plush **Standard Finish:** Traditional
COM: 14.75 yards **COL:** N/A
 Standard with small nails around the inside arm. This style is not intended to be used as a stand-alone item, it has been designed to connect with other matching sectional components.

D	E	F	G	H	J	K COM	L	M	N	O	P	Q	R	S	T	U	(# above U) *	S Nail	M Nail
2985	3027	3069	3111	3153	3195	3237	3279	3321	3363	3405	3447	3489	3531	3573	3615	3657	42 (Riser) + 3657 (U)	Std.	N/A
Leather 1 N/A		Leather 2 N/A		Leather 3 N/A		Leather 4 N/A		Leather 5 N/A		Leather 6 N/A		Leather 8 N/A		COL N/A		S Nail N/A		M Nail N/A	

Fabric SKU: **2995-27** Leather SKU: **N/A**
 KELLY

Kelly Skirted Left Arm Chaise

One Boxed Back over One Seat
Width: 31.5 **Depth:** 69 **Height:** 41
AH: 25 **SH:** 21.5 **SD:** 50 **IW:** 31
Weight: 86 lbs **Cube:** 51.57

Standard Pillows: (1) 18 x 18 **Finish Req:** N
Standard Cushions: Ultra Plush **Standard Finish:** Traditional
COM: 14.75 yards **COL:** N/A
 Standard with small nails around the inside arm. This style is not intended to be used as a stand-alone item, it has been designed to connect with other matching sectional components.

D	E	F	G	H	J	K COM	L	M	N	O	P	Q	R	S	T	U	(# above U) *	S Nail	M Nail
2985	3027	3069	3111	3153	3195	3237	3279	3321	3363	3405	3447	3489	3531	3573	3615	3657	42 (Riser) + 3657 (U)	Std.	N/A
Leather 1 N/A		Leather 2 N/A		Leather 3 N/A		Leather 4 N/A		Leather 5 N/A		Leather 6 N/A		Leather 8 N/A		COL N/A		S Nail N/A		M Nail N/A	

Fabric SKU: **2995-29** Leather SKU: **N/A**
 KELLY

Kelly Skirted Corner Chair

Two Boxed Backs over One Seat
Width: 38.5 **Depth:** 38.5 **Height:** 41
AH: 0 **SH:** 21.5 **SD:** 21.5 **IW:** 21.5
Weight: 78 lbs **Cube:** 35.16

Standard Pillows: (2) 18 x 18 **Finish Req:** N
Standard Cushions: Ultra Plush **Standard Finish:** Traditional
COM: 12.5 yards **COL:** N/A
 Standard with small nails around the inside arm

D	E	F	G	H	J	K COM	L	M	N	O	P	Q	R	S	T	U	(# above U) *	S Nail	M Nail
2625	2661	2697	2733	2769	2805	2841	2877	2913	2949	2985	3021	3057	3093	3129	3165	3201	36 (Riser) + 3201 (U)	N/A	N/A
Leather 1 N/A		Leather 2 N/A		Leather 3 N/A		Leather 4 N/A		Leather 5 N/A		Leather 6 N/A		Leather 8 N/A		COL N/A		S Nail N/A		M Nail N/A	

Fabric SKU: **2995-50** Leather SKU: **N/A**
 KELLY

Kelly Skirted Sofa

Three Boxed Backs over Three Seats
Width: 93 **Depth:** 38.5 **Height:** 41
AH: 25 **SH:** 21.5 **SD:** 21.5 **IW:** 86.5
Weight: 143 lbs **Cube:** 102.13

Standard Pillows: (2) 18 x 18 **Finish Req:** N
Standard Cushions: Ultra Plush **Standard Finish:** Traditional
COM: 23 yards **COL:** N/A
 Standard with small nails around the inside arm

D	E	F	G	H	J	K COM	L	M	N	O	P	Q	R	S	T	U	(# above U) *	S Nail	M Nail
4425	4494	4563	4632	4701	4770	4839	4908	4977	5046	5115	5184	5253	5322	5391	5460	5529	69 (Riser) + 5529 (U)	Std.	N/A
Leather 1 N/A		Leather 2 N/A		Leather 3 N/A		Leather 4 N/A		Leather 5 N/A		Leather 6 N/A		Leather 8 N/A		COL N/A		S Nail N/A		M Nail N/A	

Fabric SKU: **2995-51** Leather SKU: **N/A**
 KELLY

Kelly Skirted Right Arm Sofa

Three Boxed Backs over Three Seats
Width: 89 **Depth:** 38.5 **Height:** 41
AH: 25 **SH:** 21.5 **SD:** 21.5 **IW:** 86
Weight: 133 lbs **Cube:** 81.3

Standard Pillows: (2) 18 x 18 **Finish Req:** N
Standard Cushions: Ultra Plush **Standard Finish:** Traditional
COM: 22 yards **COL:** N/A
 Standard with small nails around the inside arm. This style is not intended to be used as a stand-alone item, it has been designed to connect with other matching sectional components.

D	E	F	G	H	J	K COM	L	M	N	O	P	Q	R	S	T	U	(# above U) *	S Nail	M Nail
4125	4188	4251	4314	4377	4440	4503	4566	4629	4692	4755	4818	4881	4944	5007	5070	5133	63 (Riser) + 5133 (U)	Std.	N/A
Leather 1 N/A		Leather 2 N/A		Leather 3 N/A		Leather 4 N/A		Leather 5 N/A		Leather 6 N/A		Leather 8 N/A		COL N/A		S Nail N/A		M Nail N/A	

Fabric SKU: **2995-52** Leather SKU: **N/A**
 KELLY

Kelly Skirted Left Arm Sofa

Three Boxed Backs over Three Seats
Width: 89 **Depth:** 38.5 **Height:** 41
AH: 25 **SH:** 21.5 **SD:** 21.5 **IW:** 86
Weight: 133 lbs **Cube:** 81.3

Standard Pillows: (2) 18 x 18 **Finish Req:** N
Standard Cushions: Ultra Plush **Standard Finish:** Traditional
COM: 22 yards **COL:** N/A
 Standard with small nails around the inside arm. This style is not intended to be used as a stand-alone item, it has been designed to connect with other matching sectional components.

D	E	F	G	H	J	K COM	L	M	N	O	P	Q	R	S	T	U	(# above U) *	S Nail	M Nail
4125	4188	4251	4314	4377	4440	4503	4566	4629	4692	4755	4818	4881	4944	5007	5070	5133	63 (Riser) + 5133 (U)	Std.	N/A
Leather 1 N/A		Leather 2 N/A		Leather 3 N/A		Leather 4 N/A		Leather 5 N/A		Leather 6 N/A		Leather 8 N/A		COL N/A		S Nail N/A		M Nail N/A	

Upholstery

**Pillows are not available on leather SKUs*

Fabric SKU: **2995-53** Leather SKU: **N/A**
KELLY

Kelly Skirted Right Arm Corner Sofa

Four Boxed Backs over Three Seats
Width: 99 **Depth:** 38.5 **Height:** 41
AH: 25 **SH:** 21.5 **SD:** 21.5 **IW:** 79
Weight: 162 lbs **Cube:** 90.43

Standard Pillows: (2) 18 x 18 **Finish Req:** N
Standard Cushions: Ultra Plush **Standard Finish:** Traditional
COM: 25.75 yards **COL:** N/A
Standard with small nails around the inside arm

D	E	F	G	H	J	K COM	L	M	N	O	P	Q	R	S	T	U	(# above U) *	S Nail	M Nail
4650	4722	4794	4866	4938	5010	5082	5154	5226	5298	5370	5442	5514	5586	5658	5730	5802	72 (Riser) + 5802 (U)	Std.	N/A
Leather 1 N/A		Leather 2 N/A		Leather 3 N/A		Leather 4 N/A		Leather 5 N/A		Leather 6 N/A		Leather 8 N/A		COL N/A		S Nail N/A		M Nail N/A	

Fabric SKU: **2995-54** Leather SKU: **N/A**
KELLY

Kelly Skirted Left Arm Corner Sofa

Four Boxed Backs over Three Seats
Width: 99 **Depth:** 38.5 **Height:** 41
AH: 25 **SH:** 21.5 **SD:** 21.5 **IW:** 79
Weight: 162 lbs **Cube:** 90.43

Standard Pillows: (2) 18 x 18 **Finish Req:** N
Standard Cushions: Ultra Plush **Standard Finish:** Traditional
COM: 25.75 yards **COL:** N/A
Standard with small nails around the inside arm

D	E	F	G	H	J	K COM	L	M	N	O	P	Q	R	S	T	U	(# above U) *	S Nail	M Nail
4650	4722	4794	4866	4938	5010	5082	5154	5226	5298	5370	5442	5514	5586	5658	5730	5802	72 (Riser) + 5802 (U)	Std.	N/A
Leather 1 N/A		Leather 2 N/A		Leather 3 N/A		Leather 4 N/A		Leather 5 N/A		Leather 6 N/A		Leather 8 N/A		COL N/A		S Nail N/A		M Nail N/A	

Fabric SKU: **2995-71** Leather SKU: **N/A**
KELLY

Kelly Skirted Right Arm Loveseat

Two Boxed Backs over Two Seats
Width: 61.25 **Depth:** 38.5 **Height:** 41
AH: 25 **SH:** 21.5 **SD:** 21.5 **IW:** 58.25
Weight: 101 lbs **Cube:** 55.95

Standard Pillows: (2) 18 x 18 **Finish Req:** N
Standard Cushions: Ultra Plush **Standard Finish:** Traditional
COM: 18.5 yards **COL:** N/A
Standard with small nails around the inside arm. This style is not intended to be used as a stand-alone item, it has been designed to connect with other matching sectional components.

D	E	F	G	H	J	K COM	L	M	N	O	P	Q	R	S	T	U	(# above U) *	S Nail	M Nail
3300	3351	3402	3453	3504	3555	3606	3657	3708	3759	3810	3861	3912	3963	4014	4065	4116	51 (Riser) + 4116 (U)	Std.	N/A
Leather 1 N/A		Leather 2 N/A		Leather 3 N/A		Leather 4 N/A		Leather 5 N/A		Leather 6 N/A		Leather 8 N/A		COL N/A		S Nail N/A		M Nail N/A	

Fabric SKU: **2995-72** Leather SKU: **N/A**
KELLY

Kelly Skirted Left Arm Loveseat

Two Boxed Backs over Two Seats
Width: 61.25 **Depth:** 38.5 **Height:** 41
AH: 25 **SH:** 21.5 **SD:** 21.5 **IW:** 58.25
Weight: 101 lbs **Cube:** 55.95

Standard Pillows: (2) 18 x 18 **Finish Req:** N
Standard Cushions: Ultra Plush **Standard Finish:** Traditional
COM: 18.5 yards **COL:** N/A
Standard with small nails around the inside arm. This style is not intended to be used as a stand-alone item, it has been designed to connect with other matching sectional components.

D	E	F	G	H	J	K COM	L	M	N	O	P	Q	R	S	T	U	(# above U) *	S Nail	M Nail
3300	3351	3402	3453	3504	3555	3606	3657	3708	3759	3810	3861	3912	3963	4014	4065	4116	51 (Riser) + 4116 (U)	Std.	N/A
Leather 1 N/A		Leather 2 N/A		Leather 3 N/A		Leather 4 N/A		Leather 5 N/A		Leather 6 N/A		Leather 8 N/A		COL N/A		S Nail N/A		M Nail N/A	

Fabric SKU: **2995-78** Leather SKU: **N/A**
KELLY

Kelly Skirted Armless Sectional Chair

One Boxed Back over One Seat
Width: 28 **Depth:** 38.5 **Height:** 41
AH: 0 **SH:** 21.5 **SD:** 21.5 **IW:** 27.75
Weight: 30 lbs **Cube:** 25.57

Standard Pillows: N/A **Finish Req:** N
Standard Cushions: Ultra Plush **Standard Finish:** Traditional
COM: 9.75 yards **COL:** N/A
This style is not intended to be used as a stand-alone item, it has been designed to connect with other matching sectional components.

D	E	F	G	H	J	K COM	L	M	N	O	P	Q	R	S	T	U	(# above U) *	S Nail	M Nail
1950	1977	2004	2031	2058	2085	2112	2139	2166	2193	2220	2247	2274	2301	2328	2355	2382	27 (Riser) + 2382 (U)	N/A	N/A
Leather 1 N/A		Leather 2 N/A		Leather 3 N/A		Leather 4 N/A		Leather 5 N/A		Leather 6 N/A		Leather 8 N/A		COL N/A		S Nail N/A		M Nail N/A	

Fabric SKU: **2996-26** Leather SKU: **N/A**
KELLY

Kelly Right Arm Chaise with Tapered Leg

One Boxed Back over One Seat
Width: 31.5 **Depth:** 69 **Height:** 41
AH: 25 **SH:** 21.5 **SD:** 50 **IW:** 31
Weight: 86 lbs **Cube:** 51.57

Standard Pillows: (1) 18 x 18 **Finish Req:** Y
Standard Cushions: Ultra Plush **Standard Finish:**
COM: 12.25 yards **COL:** N/A
Standard with small nails around the inside arm. This style is not intended to be used as a stand-alone item, it has been designed to connect with other matching sectional components.

D	E	F	G	H	J	K COM	L	M	N	O	P	Q	R	S	T	U	(# above U) *	S Nail	M Nail
2985	3018	3051	3084	3117	3150	3183	3216	3249	3282	3315	3348	3381	3414	3447	3480	3513	33 (Riser) + 3513 (U)	Std.	N/A
Leather 1 N/A		Leather 2 N/A		Leather 3 N/A		Leather 4 N/A		Leather 5 N/A		Leather 6 N/A		Leather 8 N/A		COL N/A		S Nail N/A		M Nail N/A	

Upholstery

**Pillows are not available on leather SKUs*

Fabric SKU: **2996-27** Leather SKU: **N/A**
KELLY

Kelly Left Arm Chaise with Tapered Leg

One Boxed Back over One Seat
Width: 31.5 **Depth:** 69 **Height:** 41
AH: 25 **SH:** 21.5 **SD:** 50 **IW:** 31
Weight: 86 lbs **Cube:** 51.57

Standard Pillows: (1) 18 x 18 **Finish Req:** Y
Standard Cushions: Ultra Plush **Standard Finish:**
COM: 12.25 yards **COL:** N/A
Standard with small nails around the inside arm. This style is not intended to be used as a stand-alone item, it has been designed to connect with other matching sectional components.

D	E	F	G	H	J	K COM	L	M	N	O	P	Q	R	S	T	U	(# above U) *	S Nail	M Nail
2985	3018	3051	3084	3117	3150	3183	3216	3249	3282	3315	3348	3381	3414	3447	3480	3513	33 (Riser) + 3513 (U)	Std.	N/A
Leather 1 N/A		Leather 2 N/A		Leather 3 N/A		Leather 4 N/A		Leather 5 N/A		Leather 6 N/A		Leather 8 N/A		COL N/A		S Nail N/A		M Nail N/A	

Fabric SKU: **2996-29** Leather SKU: **N/A**
KELLY

Kelly Corner Chair with Tapered Leg

Two Boxed Backs over One Seat
Width: 38.5 **Depth:** 38.5 **Height:** 41
AH: 0 **SH:** 21.5 **SD:** 21.5 **IW:** 21.5
Weight: 78 lbs **Cube:** 35.16

Standard Pillows: (2) 18 x 18 **Finish Req:** Y
Standard Cushions: Ultra Plush **Standard Finish:**
COM: 11.75 yards **COL:** N/A
Standard with small nails around the inside arm

D	E	F	G	H	J	K COM	L	M	N	O	P	Q	R	S	T	U	(# above U) *	S Nail	M Nail
2625	2658	2691	2724	2757	2790	2823	2856	2889	2922	2955	2988	3021	3054	3087	3120	3153	33 (Riser) + 3153 (U)	N/A	N/A
Leather 1 N/A		Leather 2 N/A		Leather 3 N/A		Leather 4 N/A		Leather 5 N/A		Leather 6 N/A		Leather 8 N/A		COL N/A		S Nail N/A		M Nail N/A	

Fabric SKU: **2996-50** Leather SKU: **N/A**
KELLY

Kelly Sofa with Tapered Leg

Three Boxed Backs over Three Seats
Width: 93 **Depth:** 38.5 **Height:** 41
AH: 25 **SH:** 21.5 **SD:** 21.5 **IW:** 86.5
Weight: 143 lbs **Cube:** 102.13

Standard Pillows: (2) 18 x 18 **Finish Req:** Y
Standard Cushions: Ultra Plush **Standard Finish:**
COM: 20 yards **COL:** N/A
Standard with small nails around the inside arm

D	E	F	G	H	J	K COM	L	M	N	O	P	Q	R	S	T	U	(# above U) *	S Nail	M Nail
4425	4485	4545	4605	4665	4725	4785	4845	4905	4965	5025	5085	5145	5205	5265	5325	5385	60 (Riser) + 5385 (U)	Std.	N/A
Leather 1 N/A		Leather 2 N/A		Leather 3 N/A		Leather 4 N/A		Leather 5 N/A		Leather 6 N/A		Leather 8 N/A		COL N/A		S Nail N/A		M Nail N/A	

Fabric SKU: **2996-51** Leather SKU: **N/A**
KELLY

Kelly Right Arm Sofa with Tapered Leg

Three Boxed Backs over Three Seats
Width: 89 **Depth:** 38.5 **Height:** 41
AH: 25 **SH:** 21.5 **SD:** 21.5 **IW:** 86
Weight: 133 lbs **Cube:** 81.3

Standard Pillows: (2) 18 x 18 **Finish Req:** Y
Standard Cushions: Ultra Plush **Standard Finish:**
COM: 19.75 yards **COL:** N/A
Standard with small nails around the inside arm. This style is not intended to be used as a stand-alone item, it has been designed to connect with other matching sectional components.

D	E	F	G	H	J	K COM	L	M	N	O	P	Q	R	S	T	U	(# above U) *	S Nail	M Nail
4125	4179	4233	4287	4341	4395	4449	4503	4557	4611	4665	4719	4773	4827	4881	4935	4989	54 (Riser) + 4989 (U)	Std.	N/A
Leather 1 N/A		Leather 2 N/A		Leather 3 N/A		Leather 4 N/A		Leather 5 N/A		Leather 6 N/A		Leather 8 N/A		COL N/A		S Nail N/A		M Nail N/A	

Fabric SKU: **2996-52** Leather SKU: **N/A**
KELLY

Kelly Left Arm Sofa with Tapered Leg

Three Boxed Backs over Three Seats
Width: 89 **Depth:** 38.5 **Height:** 41
AH: 25 **SH:** 21.5 **SD:** 21.5 **IW:** 86
Weight: 133 lbs **Cube:** 92.4

Standard Pillows: (2) 18 x 18 **Finish Req:** Y
Standard Cushions: Ultra Plush **Standard Finish:**
COM: 19.75 yards **COL:** N/A
Standard with small nails around the inside arm. This style is not intended to be used as a stand-alone item, it has been designed to connect with other matching sectional components.

D	E	F	G	H	J	K COM	L	M	N	O	P	Q	R	S	T	U	(# above U) *	S Nail	M Nail
4125	4179	4233	4287	4341	4395	4449	4503	4557	4611	4665	4719	4773	4827	4881	4935	4989	54 (Riser) + 4989 (U)	Std.	N/A
Leather 1 N/A		Leather 2 N/A		Leather 3 N/A		Leather 4 N/A		Leather 5 N/A		Leather 6 N/A		Leather 8 N/A		COL N/A		S Nail N/A		M Nail N/A	

Fabric SKU: **2996-53** Leather SKU: **N/A**
KELLY

Kelly Right Arm Corner Sofa with Tapered Leg

Four Boxed Backs over Three Seats
Width: 99 **Depth:** 38.5 **Height:** 41
AH: 25 **SH:** 21.5 **SD:** 21.5 **IW:** 79
Weight: 162 lbs **Cube:** 90.43

Standard Pillows: (2) 18 x 18 **Finish Req:** Y
Standard Cushions: Ultra Plush **Standard Finish:**
COM: 22.5 yards **COL:** N/A
Standard with small nails around the inside arm

D	E	F	G	H	J	K COM	L	M	N	O	P	Q	R	S	T	U	(# above U) *	S Nail	M Nail
4650	4713	4776	4839	4902	4965	5028	5091	5154	5217	5280	5343	5406	5469	5532	5595	5658	63 (Riser) + 5658 (U)	Std.	N/A
Leather 1 N/A		Leather 2 N/A		Leather 3 N/A		Leather 4 N/A		Leather 5 N/A		Leather 6 N/A		Leather 8 N/A		COL N/A		S Nail N/A		M Nail N/A	

Upholstery

**Pillows are not available on leather SKUs*

Fabric SKU: **2996-54** Leather SKU: **N/A**

KELLY

Kelly Left Arm Corner Sofa with Tapered Leg

Four Boxed Backs over Three Seats

Width: 99 **Depth:** 38.5 **Height:** 41

AH: 25 **SH:** 21.5 **SD:** 21.5 **IW:** 79

Weight: 162 lbs **Cube:** 90.43

D	E	F	G	H	J	K COM	L	M	N	O	P	Q	R	S	T	U	(# above U) *	S Nail	M Nail
4650	4713	4776	4839	4902	4965	5028	5091	5154	5217	5280	5343	5406	5469	5532	5595	5658	63 (Riser) + 5658 (U)	Std.	N/A
Leather 1		Leather 2		Leather 3		Leather 4		Leather 5		Leather 6		Leather 8		COL		S Nail		M Nail	
N/A		N/A		N/A		N/A		N/A		N/A		N/A		N/A		N/A		N/A	

Standard Pillows: (2) 18 x 18 **Finish Req:** Y

Standard Cushions: Ultra Plush **Standard Finish:**

COM: 22.5 yards **COL:** N/A

Standard with small nails around the inside arm

Fabric SKU: **2996-71** Leather SKU: **N/A**

KELLY

Kelly Right Arm Loveseat with Tapered Leg

Two Boxed Backs over Two Seats

Width: 61.25 **Depth:** 38.5 **Height:** 41

AH: 25 **SH:** 21.5 **SD:** 21.5 **IW:** 58.25

Weight: 101 lbs **Cube:** 55.95

D	E	F	G	H	J	K COM	L	M	N	O	P	Q	R	S	T	U	(# above U) *	S Nail	M Nail
3300	3345	3390	3435	3480	3525	3570	3615	3660	3705	3750	3795	3840	3885	3930	3975	4020	45 (Riser) + 4020 (U)	Std.	N/A
Leather 1		Leather 2		Leather 3		Leather 4		Leather 5		Leather 6		Leather 8		COL		S Nail		M Nail	
N/A		N/A		N/A		N/A		N/A		N/A		N/A		N/A		N/A		N/A	

Standard Pillows: (2) 18 x 18 **Finish Req:** Y

Standard Cushions: Ultra Plush **Standard Finish:**

COM: 16.25 yards **COL:** N/A

Standard with small nails around the inside arm. This style is not intended to be used as a stand-alone item, it has been designed to connect with other matching sectional components.

Fabric SKU: **2996-72** Leather SKU: **N/A**

KELLY

Kelly Left Arm Loveseat with Tapered Leg

Two Boxed Backs over Two Seats

Width: 61.25 **Depth:** 38.5 **Height:** 41

AH: 25 **SH:** 21.5 **SD:** 21.5 **IW:** 58.25

Weight: 101 lbs **Cube:** 55.95

D	E	F	G	H	J	K COM	L	M	N	O	P	Q	R	S	T	U	(# above U) *	S Nail	M Nail
3300	3345	3390	3435	3480	3525	3570	3615	3660	3705	3750	3795	3840	3885	3930	3975	4020	45 (Riser) + 4020 (U)	Std.	N/A
Leather 1		Leather 2		Leather 3		Leather 4		Leather 5		Leather 6		Leather 8		COL		S Nail		M Nail	
N/A		N/A		N/A		N/A		N/A		N/A		N/A		N/A		N/A		N/A	

Standard Pillows: (2) 18 x 18 **Finish Req:** Y

Standard Cushions: Ultra Plush **Standard Finish:**

COM: 16.25 yards **COL:** N/A

Standard with small nails around the inside arm. This style is not intended to be used as a stand-alone item, it has been designed to connect with other matching sectional components.

Fabric SKU: **2996-78** Leather SKU: **N/A**

KELLY

Kelly Armless Sectional Chair with Tapered Leg

One Boxed Back over One Seat

Width: 28 **Depth:** 38.5 **Height:** 41

AH: 0 **SH:** 21.5 **SD:** 21.5 **IW:** 27.75

Weight: 30 lbs **Cube:** 25.57

D	E	F	G	H	J	K COM	L	M	N	O	P	Q	R	S	T	U	(# above U) *	S Nail	M Nail
1950	1974	1998	2022	2046	2070	2094	2118	2142	2166	2190	2214	2238	2262	2286	2310	2334	24 (Riser) + 2334 (U)	N/A	N/A
Leather 1		Leather 2		Leather 3		Leather 4		Leather 5		Leather 6		Leather 8		COL		S Nail		M Nail	
N/A		N/A		N/A		N/A		N/A		N/A		N/A		N/A		N/A		N/A	

Standard Pillows: N/A **Finish Req:** Y

Standard Cushions: Ultra Plush **Standard Finish:**

COM: 8.75 yards **COL:** N/A

This style is not intended to be used as a stand-alone item, it has been designed to connect with other matching sectional components.

Fabric SKU: **3010-61** Leather SKU: **N/A**

Serenity Track Arm Full Size Sleeper

Two backs over two seat cushions

Width: 64.5 **Depth:** 35.25 **Height:** 33

AH: 26 **SH:** 19.5 **SD:** 19.75 **IW:** 59

Weight: 171 lbs **Cube:** 43.41

D	E	F	G	H	J	K COM	L	M	N	O	P	Q	R	S	T	U	(# above U) *	S Nail	M Nail
4725	4773	4821	4869	4917	4965	5013	5061	5109	5157	5205	5253	5301	5349	5397	5445	5493	48 (Riser) + 5493 (U)	150	N/A
Leather 1		Leather 2		Leather 3		Leather 4		Leather 5		Leather 6		Leather 8		COL		S Nail		M Nail	
N/A		N/A		N/A		N/A		N/A		N/A		N/A		N/A		N/A		N/A	

Standard Pillows: (2) 18x18 **Finish Req:** N

Standard Cushions: Endurance **Standard Finish:** Contemporary

COM: 16.25 yards **COL:** N/A

Depth of sleeper open: 87"

Fabric SKU: **3010-66** Leather SKU: **N/A**

Serenity Track Arm Twin Size Sleeper

One Back over one seat cushion

Width: 48.5 **Depth:** 35.25 **Height:** 33

AH: 26 **SH:** 19.5 **SD:** 19.75 **IW:** 42

Weight: 145 lbs **Cube:** 32.64

D	E	F	G	H	J	K COM	L	M	N	O	P	Q	R	S	T	U	(# above U) *	S Nail	M Nail
3975	4005	4035	4065	4095	4125	4155	4185	4215	4245	4275	4305	4335	4365	4395	4425	4455	30 (Riser) + 4455 (U)	135	N/A
Leather 1		Leather 2		Leather 3		Leather 4		Leather 5		Leather 6		Leather 8		COL		S Nail		M Nail	
N/A		N/A		N/A		N/A		N/A		N/A		N/A		N/A		N/A		N/A	

Standard Pillows: (2) 18x18 **Finish Req:** N

Standard Cushions: Endurance **Standard Finish:** Contemporary

COM: 10.5 yards **COL:** N/A

Depth of sleeper open: 87"

Upholstery

**Pillows are not available on leather SKUs*

Fabric SKU: N/A
PELLE PROVISIONS
Isaac Occasional Chair

Leather SKU: L-3452-01

Standard Pillows: N/A Finish Req: Y
Standard Cushions: Ultra Plush Standard Finish:
COM: N/A yards COL: 74 square feet
Only available in Leather.

Width: 25.5 Depth: 31 Height: 35
AH: 25.25 SH: 19.25 SD: 20 IW: 21.5
Weight: 32 lbs Cube: 29.69

D	E	F	G	H	J	K COM	L	M	N	O	P	Q	R	S	T	U	(# above U) *	S Nail	M Nail
N/A	N/A	N/A	N/A	N/A	N/A	N/A	N/A	N/A	N/A	N/A	N/A	N/A	N/A	N/A	N/A	N/A	N/A (Riser) + N/A (U)	N/A	N/A
Leather 1	Leather 2	Leather 3	Leather 4	Leather 5	Leather 6	Leather 8	COL	S Nail	M Nail										
2640	2760	2880	3000	3120	3240	4260	2640	N/A	N/A										

Fabric SKU: 3470-01-2

Leather SKU: L-3470-01-2

Standard Pillows: N/A Finish Req: N
Standard Cushions: High Resiliency 20 Standard Finish: Nickel
COM: 3.5 yards COL: 62 square feet
Metal Base in Nickel

Infinity Occasional Chair
Channel Quilted
Width: 27 Depth: 37.5 Height: 41
AH: 23.5 SH: 19.25 SD: 22.5 IW: 23
Weight: 65 lbs Cube: 24.02

D	E	F	G	H	J	K COM	L	M	N	O	P	Q	R	S	T	U	(# above U) *	S Nail	M Nail
2325	2337	2349	2361	2373	2385	2397	2409	2421	2433	2445	2457	2469	2481	2493	2505	2517	12 (Riser) + 2517 (U)	N/A	N/A
Leather 1	Leather 2	Leather 3	Leather 4	Leather 5	Leather 6	Leather 8	COL	S Nail	M Nail										
3075	3180	3285	3390	3495	3600	4455	2421	N/A	N/A										

Fabric SKU: 3470-01-6

Leather SKU: L-3470-01-6

Standard Pillows: N/A Finish Req: N
Standard Cushions: High Resiliency 20 Standard Finish: Brushed Brass
COM: 3.5 yards COL: 62 square feet
Metal Base in Nickel

Infinity Occasional Chair
Channel Quilted
Width: 27 Depth: 37.5 Height: 41
AH: 23.5 SH: 19.25 SD: 22.5 IW: 23
Weight: 65 lbs Cube: 24.02

D	E	F	G	H	J	K COM	L	M	N	O	P	Q	R	S	T	U	(# above U) *	S Nail	M Nail
2325	2337	2349	2361	2373	2385	2397	2409	2421	2433	2445	2457	2469	2481	2493	2505	2517	12 (Riser) + 2517 (U)	N/A	N/A
Leather 1	Leather 2	Leather 3	Leather 4	Leather 5	Leather 6	Leather 8	COL	S Nail	M Nail										
3075	3180	3285	3390	3495	3600	4455	2421	N/A	N/A										

Fabric SKU: 4500-10

Leather SKU: L-4500-10

Standard Pillows: N/A Finish Req: Y
Standard Cushions: High Resiliency 40 Standard Finish:
COM: 4.5 yards COL: 79 square feet

BD COLLECTION FOR FAIRFIELD
Otis Bench

Width: 60 Depth: 24 Height: 36
AH: 25.25 SH: 19.5 SD: 19 IW: 57
Weight: 46 lbs Cube: 44.07

D	E	F	G	H	J	K COM	L	M	N	O	P	Q	R	S	T	U	(# above U) *	S Nail	M Nail
2850	2865	2880	2895	2910	2925	2940	2955	2970	2985	3000	3015	3030	3045	3060	3075	3090	15 (Riser) + 3090 (U)	150	N/A
Leather 1	Leather 2	Leather 3	Leather 4	Leather 5	Leather 6	Leather 8	COL	S Nail	M Nail										
3825	3945	4065	4185	4305	4425	5520	2970	150	N/A										

Fabric SKU: 4501-10

Leather SKU: N/A

Standard Pillows: N/A Finish Req: Y
Standard Cushions: High Resiliency 40 Standard Finish:
COM: 2.5 yards COL: N/A

BD COLLECTION FOR FAIRFIELD
Sofia Bench

Width: 61.25 Depth: 24.5 Height: 36
AH: 23 SH: 19 SD: 21.5 IW: 57
Weight: 53 lbs Cube: 20.19

D	E	F	G	H	J	K COM	L	M	N	O	P	Q	R	S	T	U	(# above U) *	S Nail	M Nail
3825	3834	3843	3852	3861	3870	3879	3888	3897	3906	3915	3924	3933	3942	3951	3960	3969	9 (Riser) + 3969 (U)	N/A	N/A
Leather 1	Leather 2	Leather 3	Leather 4	Leather 5	Leather 6	Leather 8	COL	S Nail	M Nail										
N/A	N/A	N/A	N/A	N/A	N/A	N/A	N/A	N/A	N/A	N/A	N/A	N/A	N/A	N/A	N/A	N/A	N/A	N/A	N/A

Fabric SKU: 4502-10

Leather SKU: L-4502-10

Standard Pillows: N/A Finish Req: Y
Standard Cushions: High Resiliency 40 Standard Finish:
COM: 2.75 yards COL: 51 square feet

BD COLLECTION FOR FAIRFIELD
Lynn Bench

Width: 60.75 Depth: 21.5 Height: 18.5
AH: 0 SH: 18.5 SD: 21.5 IW: 60.75
Weight: 50 lbs Cube: 23.16

D	E	F	G	H	J	K COM	L	M	N	O	P	Q	R	S	T	U	(# above U) *	S Nail	M Nail
1710	1722	1734	1746	1758	1770	1782	1794	1806	1818	1830	1842	1854	1866	1878	1890	1902	12 (Riser) + 1902 (U)	N/A	N/A
Leather 1	Leather 2	Leather 3	Leather 4	Leather 5	Leather 6	Leather 8	COL	S Nail	M Nail										
2250	2325	2400	2475	2550	2625	3330	1806	N/A	N/A										

Upholstery

**Pillows are not available on leather SKUs*

Fabric SKU: **4503-10** Leather SKU: **N/A**
 BD COLLECTION FOR FAIRFIELD
Cathy Bench

Standard Pillows: N/A **Finish Req:** Y
Standard Cushions: High Resiliency 40 **Standard Finish:**
COM: 5.5 yards **COL:** N/A

Width: 60.75 **Depth:** 26 **Height:** 36.5
AH: 23.75 **SH:** 19.5 **SD:** 18 **IW:** 50
Weight: 64 lbs **Cube:** 55.51

D	E	F	G	H	J	K COM	L	M	N	O	P	Q	R	S	T	U	(# above U) *	S Nail	M Nail
2850	2868	2886	2904	2922	2940	2958	2976	2994	3012	3030	3048	3066	3084	3102	3120	3138	18 (Riser) + 3138 (U)	N/A	N/A
Leather 1 N/A		Leather 2 N/A		Leather 3 N/A		Leather 4 N/A		Leather 5 N/A		Leather 6 N/A		Leather 8 N/A		COL N/A		S Nail N/A		M Nail N/A	

Fabric SKU: **4599-04** Leather SKU: **L-4599-04**
 BD COLLECTION FOR FAIRFIELD
Warner Dining Chair

Standard Pillows: N/A **Finish Req:** N
Standard Cushions: High Resiliency 40 **Standard Finish:** White
COM: 1.75 yards **COL:** 34 square feet

Width: 22.5 **Depth:** 23.5 **Height:** 36.5
AH: 25.5 **SH:** 19 **SD:** 19.5 **IW:** 20.5
Weight: 31 lbs **Cube:** 11.16

D	E	F	G	H	J	K COM	L	M	N	O	P	Q	R	S	T	U	(# above U) *	S Nail	M Nail
1125	1131	1137	1143	1149	1155	1161	1167	1173	1179	1185	1191	1197	1203	1209	1215	1221	6 (Riser) + 1221 (U)	N/A	N/A
Leather 1 1485		Leather 2 1545		Leather 3 1605		Leather 4 1665		Leather 5 1725		Leather 6 1785		Leather 8 2250		COL 1173		S Nail N/A		M Nail N/A	

Fabric SKU: **4599-06** Leather SKU: **L-4599-06**
 BD COLLECTION FOR FAIRFIELD
Warner Bar Stool

Standard Pillows: N/A **Finish Req:** N
Standard Cushions: High Resiliency 40 **Standard Finish:** White
COM: 1.75 yards **COL:** 34 square feet

Width: 21 **Depth:** 23 **Height:** 46.5
AH: 36 **SH:** 31 **SD:** 19 **IW:** 14
Weight: 24 lbs **Cube:** 12.99

D	E	F	G	H	J	K COM	L	M	N	O	P	Q	R	S	T	U	(# above U) *	S Nail	M Nail
1350	1356	1362	1368	1374	1380	1386	1392	1398	1404	1410	1416	1422	1428	1434	1440	1446	6 (Riser) + 1446 (U)	N/A	N/A
Leather 1 1725		Leather 2 1785		Leather 3 1845		Leather 4 1905		Leather 5 1965		Leather 6 2025		Leather 8 2490		COL 1398		S Nail N/A		M Nail N/A	

Fabric SKU: **4599-C6** Leather SKU: **L-4599-C6**
 BD COLLECTION FOR FAIRFIELD
Warner Counter Stool

Standard Pillows: N/A **Finish Req:** N
Standard Cushions: High Resiliency 40 **Standard Finish:** White
COM: 1.75 yards **COL:** 34 square feet

Width: 21 **Depth:** 23 **Height:** 42.5
AH: 32 **SH:** 27 **SD:** 19 **IW:** 14
Weight: 24 lbs **Cube:** 11.87

D	E	F	G	H	J	K COM	L	M	N	O	P	Q	R	S	T	U	(# above U) *	S Nail	M Nail
1350	1356	1362	1368	1374	1380	1386	1392	1398	1404	1410	1416	1422	1428	1434	1440	1446	6 (Riser) + 1446 (U)	N/A	N/A
Leather 1 1725		Leather 2 1785		Leather 3 1845		Leather 4 1905		Leather 5 1965		Leather 6 2025		Leather 8 2490		COL 1398		S Nail N/A		M Nail N/A	

Fabric SKU: **4600-06** Leather SKU: **L-4600-06**
 BD COLLECTION FOR FAIRFIELD
Warner Bar Stool

Standard Pillows: N/A **Finish Req:** N
Standard Cushions: High Resiliency 40 **Standard Finish:** Black
COM: 1.75 yards **COL:** 34 square feet

Width: 21 **Depth:** 23 **Height:** 46.5
AH: 36 **SH:** 31 **SD:** 19 **IW:** 14
Weight: 24 lbs **Cube:** 12.99

D	E	F	G	H	J	K COM	L	M	N	O	P	Q	R	S	T	U	(# above U) *	S Nail	M Nail
1350	1356	1362	1368	1374	1380	1386	1392	1398	1404	1410	1416	1422	1428	1434	1440	1446	6 (Riser) + 1446 (U)	N/A	N/A
Leather 1 1725		Leather 2 1785		Leather 3 1845		Leather 4 1905		Leather 5 1965		Leather 6 2025		Leather 8 2490		COL 1398		S Nail N/A		M Nail N/A	

Fabric SKU: **4600-C6** Leather SKU: **L-4600-C6**
 BD COLLECTION FOR FAIRFIELD
Warner Counter Stool

Standard Pillows: N/A **Finish Req:** N
Standard Cushions: High Resiliency 40 **Standard Finish:** Black
COM: 1.75 yards **COL:** 34 square feet

Width: 21 **Depth:** 23 **Height:** 42.5
AH: 32 **SH:** 27 **SD:** 19 **IW:** 14
Weight: 24 lbs **Cube:** 11.87

D	E	F	G	H	J	K COM	L	M	N	O	P	Q	R	S	T	U	(# above U) *	S Nail	M Nail
1350	1356	1362	1368	1374	1380	1386	1392	1398	1404	1410	1416	1422	1428	1434	1440	1446	6 (Riser) + 1446 (U)	N/A	N/A
Leather 1 1725		Leather 2 1785		Leather 3 1845		Leather 4 1905		Leather 5 1965		Leather 6 2025		Leather 8 2490		COL 1398		S Nail N/A		M Nail N/A	

Upholstery

**Pillows are not available on leather SKUs*

Fabric SKU: **4601-04** Leather SKU: **L-4601-04**

BD COLLECTION FOR FAIRFIELD

Brady Dining Chair

Standard Pillows: N/A **Finish Req:** Y

Standard Cushions: High Resiliency 40 **Standard Finish:**

COM: 1.5 yards **COL:** 29 square feet

Width: 24 **Depth:** 24.5 **Height:** 42.5

AH: 25 **SH:** 19 **SD:** 19.5 **IW:** 20

Weight: 20 lbs **Cube:** 14.46

D	E	F	G	H	J	K COM	L	M	N	O	P	Q	R	S	T	U	(# above U) *	S Nail	M Nail
1155	1161	1167	1173	1179	1185	1191	1197	1203	1209	1215	1221	1227	1233	1239	1245	1251	6 (Riser) + 1251 (U)	45	60
Leather 1 1500		Leather 2 1545		Leather 3 1590		Leather 4 1635		Leather 5 1680		Leather 6 1725		Leather 8 2130		COL 1203		S Nail 45		M Nail 60	

Fabric SKU: **4601-A2** Leather SKU: **L-4601-A2**

BD COLLECTION FOR FAIRFIELD

Brady Dining Chair

Two Casters

Width: 24 **Depth:** 24.5 **Height:** 42.5

AH: 25 **SH:** 19 **SD:** 19.5 **IW:** 20

Weight: 20 lbs **Cube:** 14.46

D	E	F	G	H	J	K COM	L	M	N	O	P	Q	R	S	T	U	(# above U) *	S Nail	M Nail
1191	1197	1203	1209	1215	1221	1227	1233	1239	1245	1251	1257	1263	1269	1275	1281	1287	6 (Riser) + 1287 (U)	45	60
Leather 1 1530		Leather 2 1575		Leather 3 1620		Leather 4 1665		Leather 5 1710		Leather 6 1755		Leather 8 2160		COL 1239		S Nail 45		M Nail 60	

Standard Pillows: N/A **Finish Req:** Y

Standard Cushions: High Resiliency 40 **Standard Finish:**

COM: 1.5 yards **COL:** 29 square feet

Fabric SKU: **4601-C6** Leather SKU: **L-4601-C6**

BD COLLECTION FOR FAIRFIELD

Brady Counter Stool

Width: 23.5 **Depth:** 23.5 **Height:** 43

AH: 32.5 **SH:** 26 **SD:** 20 **IW:** 19

Weight: 20 lbs **Cube:** 13.74

D	E	F	G	H	J	K COM	L	M	N	O	P	Q	R	S	T	U	(# above U) *	S Nail	M Nail
1275	1281	1287	1293	1299	1305	1311	1317	1323	1329	1335	1341	1347	1353	1359	1365	1371	6 (Riser) + 1371 (U)	45	60
Leather 1 1575		Leather 2 1620		Leather 3 1665		Leather 4 1710		Leather 5 1755		Leather 6 1800		Leather 8 2205		COL 1323		S Nail 45		M Nail 60	

Standard Pillows: N/A **Finish Req:** Y

Standard Cushions: High Resiliency 40 **Standard Finish:**

COM: 1.5 yards **COL:** 29 square feet

Fabric SKU: **4603-04** Leather SKU: **N/A**

BD COLLECTION FOR FAIRFIELD

Wren Dining Chair

Width: 24 **Depth:** 27 **Height:** 42.25

AH: 26.5 **SH:** 20.5 **SD:** 20 **IW:** 20.75

Weight: 30 lbs **Cube:** 15.84

D	E	F	G	H	J	K COM	L	M	N	O	P	Q	R	S	T	U	(# above U) *	S Nail	M Nail
1395	1404	1413	1422	1431	1440	1449	1458	1467	1476	1485	1494	1503	1512	1521	1530	1539	9 (Riser) + 1539 (U)	N/A	N/A
Leather 1 N/A		Leather 2 N/A		Leather 3 N/A		Leather 4 N/A		Leather 5 N/A		Leather 6 N/A		Leather 8 N/A		COL N/A		S Nail N/A		M Nail N/A	

Standard Pillows: N/A **Finish Req:** Y

Standard Cushions: High Resiliency 40 **Standard Finish:**

COM: 2.5 yards **COL:** N/A

Fabric SKU: **4603-06** Leather SKU: **N/A**

BD COLLECTION FOR FAIRFIELD

Wren Bar Stool

Width: 24 **Depth:** 27 **Height:** 50.75

AH: 37.75 **SH:** 30 **SD:** 20 **IW:** 20.75

Weight: 32 lbs **Cube:** 19.03

D	E	F	G	H	J	K COM	L	M	N	O	P	Q	R	S	T	U	(# above U) *	S Nail	M Nail
1485	1494	1503	1512	1521	1530	1539	1548	1557	1566	1575	1584	1593	1602	1611	1620	1629	9 (Riser) + 1629 (U)	N/A	N/A
Leather 1 N/A		Leather 2 N/A		Leather 3 N/A		Leather 4 N/A		Leather 5 N/A		Leather 6 N/A		Leather 8 N/A		COL N/A		S Nail N/A		M Nail N/A	

Standard Pillows: N/A **Finish Req:** Y

Standard Cushions: High Resiliency 40 **Standard Finish:**

COM: 2.5 yards **COL:** N/A

Fabric SKU: **4603-A2** Leather SKU: **N/A**

BD COLLECTION FOR FAIRFIELD

Wren Dining Chair

with two front casters

Width: 24 **Depth:** 27 **Height:** 42.25

AH: 26.5 **SH:** 20.5 **SD:** 20 **IW:** 20.75

Weight: 30 lbs **Cube:** 15.84

D	E	F	G	H	J	K COM	L	M	N	O	P	Q	R	S	T	U	(# above U) *	S Nail	M Nail
1431	1440	1449	1458	1467	1476	1485	1494	1503	1512	1521	1530	1539	1548	1557	1566	1575	9 (Riser) + 1575 (U)	N/A	N/A
Leather 1 N/A		Leather 2 N/A		Leather 3 N/A		Leather 4 N/A		Leather 5 N/A		Leather 6 N/A		Leather 8 N/A		COL N/A		S Nail N/A		M Nail N/A	

Standard Pillows: N/A **Finish Req:** Y

Standard Cushions: High Resiliency 40 **Standard Finish:**

COM: 2.5 yards **COL:** N/A

Upholstery

**Pillows are not available on leather SKUs*

Fabric SKU: **4603-C6** Leather SKU: **N/A**
 BD COLLECTION FOR FAIRFIELD
Wren Counter Stool

Standard Pillows: N/A **Finish Req:** Y
Standard Cushions: High Resiliency 40 **Standard Finish:**
COM: 2.5 yards **COL:** N/A

Width: 24 **Depth:** 27 **Height:** 46.75
AH: 33.25 **SH:** 26 **SD:** 20 **IW:** 20.75
Weight: 31 lbs **Cube:** 17.53

D	E	F	G	H	J	K COM	L	M	N	O	P	Q	R	S	T	U	(# above U) *	S Nail	M Nail
1485	1494	1503	1512	1521	1530	1539	1548	1557	1566	1575	1584	1593	1602	1611	1620	1629	9 (Riser) + 1629 (U)	N/A	N/A
Leather 1 N/A		Leather 2 N/A		Leather 3 N/A		Leather 4 N/A		Leather 5 N/A		Leather 6 N/A		Leather 8 N/A		COL N/A		S Nail N/A		M Nail N/A	

Fabric SKU: **4604-04** Leather SKU: **L-4604-04**
 BD COLLECTION FOR FAIRFIELD
Xander Dining Chair

Standard Pillows: N/A **Finish Req:** Y
Standard Cushions: High Resiliency 40 **Standard Finish:**
COM: 2 yards **COL:** 40 square feet

Width: 23.5 **Depth:** 24 **Height:** 39.5
AH: 25 **SH:** 19 **SD:** 18.5 **IW:** 18.5
Weight: 20 lbs **Cube:** 12.89

D	E	F	G	H	J	K COM	L	M	N	O	P	Q	R	S	T	U	(# above U) *	S Nail	M Nail
1245	1251	1257	1263	1269	1275	1281	1287	1293	1299	1305	1311	1317	1323	1329	1335	1341	6 (Riser) + 1341 (U)	N/A	N/A
Leather 1 1725		Leather 2 1785		Leather 3 1845		Leather 4 1905		Leather 5 1965		Leather 6 2025		Leather 8 2580		COL 1293		S Nail N/A		M Nail N/A	

Fabric SKU: **4604-A2** Leather SKU: **L-4604-A2**
 BD COLLECTION FOR FAIRFIELD
Xander Dining Chair

Standard Pillows: N/A **Finish Req:** Y
Standard Cushions: High Resiliency 40 **Standard Finish:**
COM: 2 yards **COL:** 40 square feet

Two Casters
Width: 23.5 **Depth:** 24 **Height:** 39.5
AH: 25 **SH:** 19 **SD:** 18.5 **IW:** 18.5
Weight: 20 lbs **Cube:** 12.89

D	E	F	G	H	J	K COM	L	M	N	O	P	Q	R	S	T	U	(# above U) *	S Nail	M Nail
1281	1287	1293	1299	1305	1311	1317	1323	1329	1335	1341	1347	1353	1359	1365	1371	1377	6 (Riser) + 1377 (U)	N/A	N/A
Leather 1 1770		Leather 2 1830		Leather 3 1890		Leather 4 1950		Leather 5 2010		Leather 6 2070		Leather 8 2625		COL 1329		S Nail N/A		M Nail N/A	

Fabric SKU: **4604-C6** Leather SKU: **L-4604-C6**
 BD COLLECTION FOR FAIRFIELD
Xander Counter Stool

Standard Pillows: N/A **Finish Req:** Y
Standard Cushions: High Resiliency 40 **Standard Finish:**
COM: 2 yards **COL:** 40 square feet

Width: 23.5 **Depth:** 24 **Height:** 42
AH: 30 **SH:** 25.5 **SD:** 18.5 **IW:** 18.5
Weight: 23 lbs **Cube:** 13.7

D	E	F	G	H	J	K COM	L	M	N	O	P	Q	R	S	T	U	(# above U) *	S Nail	M Nail
1350	1356	1362	1368	1374	1380	1386	1392	1398	1404	1410	1416	1422	1428	1434	1440	1446	6 (Riser) + 1446 (U)	N/A	N/A
Leather 1 1875		Leather 2 1935		Leather 3 1995		Leather 4 2055		Leather 5 2115		Leather 6 2175		Leather 8 2730		COL 1398		S Nail N/A		M Nail N/A	

Fabric SKU: **4605-04** Leather SKU: **L-4605-04**
 BD COLLECTION FOR FAIRFIELD
Anderson Arm Chair

Standard Pillows: N/A **Finish Req:** Y
Standard Cushions: High Resiliency 40 **Standard Finish:**
COM: 3.75 yards **COL:** 68 square feet

Width: 24.5 **Depth:** 28.5 **Height:** 39.5
AH: 25.25 **SH:** 19.5 **SD:** 19.5 **IW:** 19.5
Weight: 25 lbs **Cube:** 21.65

D	E	F	G	H	J	K COM	L	M	N	O	P	Q	R	S	T	U	(# above U) *	S Nail	M Nail
1734	1746	1758	1770	1782	1794	1806	1818	1830	1842	1854	1866	1878	1890	1902	1914	1926	12 (Riser) + 1926 (U)	N/A	N/A
Leather 1 2745		Leather 2 2850		Leather 3 2955		Leather 4 3060		Leather 5 3165		Leather 6 3270		Leather 8 4215		COL 1830		S Nail N/A		M Nail N/A	

Fabric SKU: **4605-04-P** Leather SKU: **L-4605-04-P**
 BD COLLECTION FOR FAIRFIELD
Anderson Arm Chair with Pull

Standard Pillows: N/A **Finish Req:** Y
Standard Cushions: High Resiliency 40 **Standard Finish:**
COM: 3.75 yards **COL:** 68 square feet
 Features a decorative leather handle with cream accent stitching.

Width: 24.5 **Depth:** 28.5 **Height:** 39.5
AH: 25.25 **SH:** 19.5 **SD:** 19.5 **IW:** 19.5
Weight: 25 lbs **Cube:** 21.65

D	E	F	G	H	J	K COM	L	M	N	O	P	Q	R	S	T	U	(# above U) *	S Nail	M Nail
1764	1776	1788	1800	1812	1824	1836	1848	1860	1872	1884	1896	1908	1920	1932	1944	1956	12 (Riser) + 1956 (U)	N/A	N/A
Leather 1 2775		Leather 2 2880		Leather 3 2985		Leather 4 3090		Leather 5 3195		Leather 6 3300		Leather 8 4245		COL 1860		S Nail N/A		M Nail N/A	

Upholstery

**Pillows are not available on leather SKUs*

Fabric SKU: **4605-06** Leather SKU: **L-4605-06**
 BD COLLECTION FOR FAIRFIELD
Anderson Arm Bar Stool

Standard Pillows: N/A **Finish Req:** Y
Standard Cushions: High Resiliency 40 **Standard Finish:**
COM: 3.75 yards **COL:** 57 square feet

Width: 24.5 **Depth:** 26 **Height:** 44
AH: 36 **SH:** 31 **SD:** 19.5 **IW:** 19.5
Weight: 30 lbs **Cube:** 24.14

D	E	F	G	H	J	K COM	L	M	N	O	P	Q	R	S	T	U	(# above U) *	S Nail	M Nail
1764	1776	1788	1800	1812	1824	1836	1848	1860	1872	1884	1896	1908	1920	1932	1944	1956	12 (Riser) + 1956 (U)	N/A	N/A
Leather 1 2745		Leather 2 2835		Leather 3 2925		Leather 4 3015		Leather 5 3105		Leather 6 3195		Leather 8 3990		COL 1860		S Nail N/A		M Nail N/A	

Fabric SKU: **4605-06-P** Leather SKU: **L-4605-06-P**
 BD COLLECTION FOR FAIRFIELD
Anderson Arm Bar Stool with Pull

Standard Pillows: N/A **Finish Req:** Y
Standard Cushions: High Resiliency 40 **Standard Finish:**
COM: 3.75 yards **COL:** 57 square feet
 Features a decorative leather handle with cream accent stitching.

Width: 24.5 **Depth:** 26 **Height:** 44
AH: 36 **SH:** 31 **SD:** 19.5 **IW:** 19.5
Weight: 30 lbs **Cube:** 19.6

D	E	F	G	H	J	K COM	L	M	N	O	P	Q	R	S	T	U	(# above U) *	S Nail	M Nail
1794	1806	1818	1830	1842	1854	1866	1878	1890	1902	1914	1926	1938	1950	1962	1974	1986	12 (Riser) + 1986 (U)	N/A	N/A
Leather 1 2775		Leather 2 2865		Leather 3 2955		Leather 4 3045		Leather 5 3135		Leather 6 3225		Leather 8 4020		COL 1890		S Nail N/A		M Nail N/A	

Fabric SKU: **4605-A2** Leather SKU: **L-4605-A2**
 BD COLLECTION FOR FAIRFIELD
Anderson Arm Chair

Standard Pillows: N/A **Finish Req:** Y
Standard Cushions: High Resiliency 40 **Standard Finish:**
COM: 3.75 yards **COL:** 68 square feet

Width: 24.5 **Depth:** 28.5 **Height:** 39.5
AH: 25.25 **SH:** 19.5 **SD:** 19.5 **IW:** 19.5
Weight: 25 lbs **Cube:** 21.65

D	E	F	G	H	J	K COM	L	M	N	O	P	Q	R	S	T	U	(# above U) *	S Nail	M Nail
1770	1782	1794	1806	1818	1830	1842	1854	1866	1878	1890	1902	1914	1926	1938	1950	1962	12 (Riser) + 1962 (U)	N/A	N/A
Leather 1 2775		Leather 2 2880		Leather 3 2985		Leather 4 3090		Leather 5 3195		Leather 6 3300		Leather 8 4245		COL 1866		S Nail N/A		M Nail N/A	

Fabric SKU: **4605-A2-P** Leather SKU: **L-4605-A2-P**
 BD COLLECTION FOR FAIRFIELD
Anderson Arm Chair with Pull

Standard Pillows: N/A **Finish Req:** Y
Standard Cushions: High Resiliency 40 **Standard Finish:**
COM: 3.75 yards **COL:** 68 square feet
 Features a decorative leather handle with cream accent stitching.

Width: 24.5 **Depth:** 28.5 **Height:** 39.5
AH: 25.25 **SH:** 19.5 **SD:** 19.5 **IW:** 19.5
Weight: 25 lbs **Cube:** 21.65

D	E	F	G	H	J	K COM	L	M	N	O	P	Q	R	S	T	U	(# above U) *	S Nail	M Nail
1800	1812	1824	1836	1848	1860	1872	1884	1896	1908	1920	1932	1944	1956	1968	1980	1992	12 (Riser) + 1992 (U)	N/A	N/A
Leather 1 2805		Leather 2 2910		Leather 3 3015		Leather 4 3120		Leather 5 3225		Leather 6 3330		Leather 8 4275		COL 1896		S Nail N/A		M Nail N/A	

Fabric SKU: **4605-A4** Leather SKU: **L-4605-A4**
 BD COLLECTION FOR FAIRFIELD
Anderson Arm Chair

Standard Pillows: N/A **Finish Req:** Y
Standard Cushions: High Resiliency 40 **Standard Finish:**
COM: 3.75 yards **COL:** 68 square feet

Width: 24.5 **Depth:** 28.5 **Height:** 39.5
AH: 25.25 **SH:** 19.5 **SD:** 19.5 **IW:** 19.5
Weight: 25 lbs **Cube:** 21.65

D	E	F	G	H	J	K COM	L	M	N	O	P	Q	R	S	T	U	(# above U) *	S Nail	M Nail
1806	1818	1830	1842	1854	1866	1878	1890	1902	1914	1926	1938	1950	1962	1974	1986	1998	12 (Riser) + 1998 (U)	N/A	N/A
Leather 1 2820		Leather 2 2925		Leather 3 3030		Leather 4 3135		Leather 5 3240		Leather 6 3345		Leather 8 4290		COL 1902		S Nail N/A		M Nail N/A	

Fabric SKU: **4605-A4-P** Leather SKU: **L-4605-A4-P**
 BD COLLECTION FOR FAIRFIELD
Anderson Arm Chair with Pull

Standard Pillows: N/A **Finish Req:** Y
Standard Cushions: High Resiliency 40 **Standard Finish:**
COM: 3.75 yards **COL:** 68 square feet
 Features a decorative leather handle with cream accent stitching.

Width: 24.5 **Depth:** 28.5 **Height:** 39.5
AH: 25.25 **SH:** 19.5 **SD:** 19.5 **IW:** 19.5
Weight: 25 lbs **Cube:** 21.65

D	E	F	G	H	J	K COM	L	M	N	O	P	Q	R	S	T	U	(# above U) *	S Nail	M Nail
1836	1848	1860	1872	1884	1896	1908	1920	1932	1944	1956	1968	1980	1992	2004	2016	2028	12 (Riser) + 2028 (U)	N/A	N/A
Leather 1 2850		Leather 2 2955		Leather 3 3060		Leather 4 3165		Leather 5 3270		Leather 6 3375		Leather 8 4320		COL 1932		S Nail N/A		M Nail N/A	

Upholstery

**Pillows are not available on leather SKUs*

Fabric SKU: **4605-C6** Leather SKU: **L-4605-C6**

BD COLLECTION FOR FAIRFIELD

Anderson Arm Counter Stool

Standard Pillows: N/A **Finish Req:** Y

Standard Cushions: High Resiliency 40 **Standard Finish:**

COM: 3.75 yards **COL:** 57 square feet

Width: 24.5 **Depth:** 26 **Height:** 40

AH: 32 **SH:** 27 **SD:** 19.5 **IW:** 19.5

Weight: 29 lbs **Cube:** 21.65

D	E	F	G	H	J	K COM	L	M	N	O	P	Q	R	S	T	U	(# above U) *	S Nail	M Nail
1764	1776	1788	1800	1812	1824	1836	1848	1860	1872	1884	1896	1908	1920	1932	1944	1956	12 (Riser) + 1956 (U)	N/A	N/A
Leather 1 2745		Leather 2 2835		Leather 3 2925		Leather 4 3015		Leather 5 3105		Leather 6 3195		Leather 8 3990		COL 1860		S Nail N/A		M Nail N/A	

Fabric SKU: **4605-C6-P** Leather SKU: **L-4605-C6-P**

BD COLLECTION FOR FAIRFIELD

Anderson Arm Counter Stool

Standard Pillows: N/A **Finish Req:** Y

Standard Cushions: High Resiliency 40 **Standard Finish:**

COM: 3.75 yards **COL:** 57 square feet

Features a decorative leather handle with cream accent stitching.

Width: 24.5 **Depth:** 26 **Height:** 40

AH: 32 **SH:** 27 **SD:** 19.5 **IW:** 19.5

Weight: 29 lbs **Cube:** 17.77

D	E	F	G	H	J	K COM	L	M	N	O	P	Q	R	S	T	U	(# above U) *	S Nail	M Nail
1794	1806	1818	1830	1842	1854	1866	1878	1890	1902	1914	1926	1938	1950	1962	1974	1986	12 (Riser) + 1986 (U)	N/A	N/A
Leather 1 2775		Leather 2 2865		Leather 3 2955		Leather 4 3045		Leather 5 3135		Leather 6 3225		Leather 8 4020		COL 1890		S Nail N/A		M Nail N/A	

Fabric SKU: **4606-04** Leather SKU: **L-4606-04**

BD COLLECTION FOR FAIRFIELD

Gigi Arm Chair

Standard Pillows: N/A **Finish Req:** Y

Standard Cushions: High Resiliency 40 **Standard Finish:**

COM: 3.5 yards **COL:** 57 square feet

Width: 27.5 **Depth:** 25 **Height:** 33.5

AH: 25.5 **SH:** 18.5 **SD:** 18.5 **IW:** 20.25

Weight: 27 lbs **Cube:** 21.65

D	E	F	G	H	J	K COM	L	M	N	O	P	Q	R	S	T	U	(# above U) *	S Nail	M Nail
2160	2172	2184	2196	2208	2220	2232	2244	2256	2268	2280	2292	2304	2316	2328	2340	2352	12 (Riser) + 2352 (U)	N/A	N/A
Leather 1 3060		Leather 2 3165		Leather 3 3270		Leather 4 3375		Leather 5 3480		Leather 6 3585		Leather 8 4440		COL 2256		S Nail N/A		M Nail N/A	

Fabric SKU: **4606-A2** Leather SKU: **L-4606-A2**

BD COLLECTION FOR FAIRFIELD

Gigi Arm Chair

Standard Pillows: N/A **Finish Req:** Y

Standard Cushions: High Resiliency 40 **Standard Finish:**

COM: 3.5 yards **COL:** 57 square feet

Width: 27.5 **Depth:** 25 **Height:** 33.5

AH: 25.5 **SH:** 18.5 **SD:** 18.5 **IW:** 20.25

Weight: 27 lbs **Cube:** 21.65

D	E	F	G	H	J	K COM	L	M	N	O	P	Q	R	S	T	U	(# above U) *	S Nail	M Nail
2196	2208	2220	2232	2244	2256	2268	2280	2292	2304	2316	2328	2340	2352	2364	2376	2388	12 (Riser) + 2388 (U)	N/A	N/A
Leather 1 3090		Leather 2 3195		Leather 3 3300		Leather 4 3405		Leather 5 3510		Leather 6 3615		Leather 8 4470		COL 2292		S Nail N/A		M Nail N/A	

Fabric SKU: **4606-A4** Leather SKU: **L-4606-A4**

BD COLLECTION FOR FAIRFIELD

Gigi Arm Chair

Standard Pillows: N/A **Finish Req:** Y

Standard Cushions: High Resiliency 40 **Standard Finish:**

COM: 3.5 yards **COL:** 57 square feet

Width: 27.5 **Depth:** 25 **Height:** 33.5

AH: 25.5 **SH:** 18.5 **SD:** 18.5 **IW:** 20.25

Weight: 27 lbs **Cube:** 21.65

D	E	F	G	H	J	K COM	L	M	N	O	P	Q	R	S	T	U	(# above U) *	S Nail	M Nail
2232	2244	2256	2268	2280	2292	2304	2316	2328	2340	2352	2364	2376	2388	2400	2412	2424	12 (Riser) + 2424 (U)	N/A	N/A
Leather 1 3135		Leather 2 3240		Leather 3 3345		Leather 4 3450		Leather 5 3555		Leather 6 3660		Leather 8 4515		COL 2328		S Nail N/A		M Nail N/A	

Fabric SKU: **4606-C6** Leather SKU: **L-4606-C6**

BD COLLECTION FOR FAIRFIELD

Gigi Arm Counter Stool

Standard Pillows: N/A **Finish Req:** Y

Standard Cushions: High Resiliency 40 **Standard Finish:**

COM: 3.5 yards **COL:** 62 square feet

Width: 27.5 **Depth:** 25 **Height:** 40

AH: 32 **SH:** 25 **SD:** 18.5 **IW:** 20.25

Weight: 30 lbs **Cube:** 21.65

D	E	F	G	H	J	K COM	L	M	N	O	P	Q	R	S	T	U	(# above U) *	S Nail	M Nail
2160	2172	2184	2196	2208	2220	2232	2244	2256	2268	2280	2292	2304	2316	2328	2340	2352	12 (Riser) + 2352 (U)	N/A	N/A
Leather 1 3060		Leather 2 3165		Leather 3 3270		Leather 4 3375		Leather 5 3480		Leather 6 3585		Leather 8 4440		COL 2256		S Nail N/A		M Nail N/A	

Upholstery

**Pillows are not available on leather SKUs*

Fabric SKU: **4608-04** Leather SKU: **L-4608-04**
 BD COLLECTION FOR FAIRFIELD
Gerheart Dining Chair

Standard Pillows: N/A **Finish Req:** Y
Standard Cushions: High Resiliency 40 **Standard Finish:**
COM: 2.25 yards **COL:** 45 square feet

Width: 24 **Depth:** 24.5 **Height:** 38
AH: 25.5 **SH:** 20 **SD:** 20 **IW:** 18
Weight: 23 lbs **Cube:** 23.89

D	E	F	G	H	J	K COM	L	M	N	O	P	Q	R	S	T	U	(# above U) *	S Nail	M Nail
1200	1206	1212	1218	1224	1230	1236	1242	1248	1254	1260	1266	1272	1278	1284	1290	1296	6 (Riser) + 1296 (U)	45	N/A
Leather 1 1755		Leather 2 1830		Leather 3 1905		Leather 4 1980		Leather 5 2055		Leather 6 2130		Leather 8 2760		COL 1248		S Nail 45		M Nail N/A	

Fabric SKU: **4608-A2** Leather SKU: **L-4608-A2**
 BD COLLECTION FOR FAIRFIELD
Gerheart Dining Chair

Standard Pillows: N/A **Finish Req:** Y
Standard Cushions: High Resiliency 40 **Standard Finish:**
COM: 2.25 yards **COL:** 45 square feet

Two Casters
Width: 24 **Depth:** 24.5 **Height:** 38
AH: 25.5 **SH:** 20 **SD:** 20 **IW:** 18
Weight: 23 lbs **Cube:** 12.93

D	E	F	G	H	J	K COM	L	M	N	O	P	Q	R	S	T	U	(# above U) *	S Nail	M Nail
1236	1242	1248	1254	1260	1266	1272	1278	1284	1290	1296	1302	1308	1314	1320	1326	1332	6 (Riser) + 1332 (U)	45	N/A
Leather 1 1785		Leather 2 1860		Leather 3 1935		Leather 4 2010		Leather 5 2085		Leather 6 2160		Leather 8 2790		COL 1284		S Nail 45		M Nail N/A	

Fabric SKU: **4608-A4** Leather SKU: **L-4608-A4**
 BD COLLECTION FOR FAIRFIELD
Gerheart Dining Chair

Standard Pillows: N/A **Finish Req:** Y
Standard Cushions: High Resiliency 40 **Standard Finish:**
COM: 2.25 yards **COL:** 45 square feet

Four Casters
Width: 24 **Depth:** 24.5 **Height:** 38
AH: 25.5 **SH:** 20 **SD:** 20 **IW:** 18
Weight: 23 lbs **Cube:** 12.93

D	E	F	G	H	J	K COM	L	M	N	O	P	Q	R	S	T	U	(# above U) *	S Nail	M Nail
1272	1278	1284	1290	1296	1302	1308	1314	1320	1326	1332	1338	1344	1350	1356	1362	1368	6 (Riser) + 1368 (U)	45	N/A
Leather 1 1830		Leather 2 1905		Leather 3 1980		Leather 4 2055		Leather 5 2130		Leather 6 2205		Leather 8 2835		COL 1320		S Nail 45		M Nail N/A	

Fabric SKU: **4608-C6** Leather SKU: **L-4608-C6**
 BD COLLECTION FOR FAIRFIELD
Gerheart Counter Stool

Standard Pillows: N/A **Finish Req:** Y
Standard Cushions: High Resiliency 40 **Standard Finish:**
COM: 2 yards **COL:** 45 square feet

Width: 21 **Depth:** 23.5 **Height:** 42.5
AH: 32 **SH:** 27 **SD:** 19 **IW:** 14
Weight: 24 lbs **Cube:** 12.13

D	E	F	G	H	J	K COM	L	M	N	O	P	Q	R	S	T	U	(# above U) *	S Nail	M Nail
1275	1281	1287	1293	1299	1305	1311	1317	1323	1329	1335	1341	1347	1353	1359	1365	1371	6 (Riser) + 1371 (U)	45	N/A
Leather 1 1800		Leather 2 1875		Leather 3 1950		Leather 4 2025		Leather 5 2100		Leather 6 2175		Leather 8 2805		COL 1323		S Nail 45		M Nail N/A	

Fabric SKU: **4615-04** Leather SKU: **N/A**
 BD COLLECTION FOR FAIRFIELD
Anderson Arm Chair with Half Skirt

Standard Pillows: N/A **Finish Req:** Y
Standard Cushions: High Resiliency 40 **Standard Finish:**
COM: 4.5 yards **COL:** N/A

Width: 24.5 **Depth:** 28.5 **Height:** 39.5
AH: 25.25 **SH:** 19.5 **SD:** 19.5 **IW:** 19.5
Weight: 25 lbs **Cube:** 21.65

D	E	F	G	H	J	K COM	L	M	N	O	P	Q	R	S	T	U	(# above U) *	S Nail	M Nail
1890	1905	1920	1935	1950	1965	1980	1995	2010	2025	2040	2055	2070	2085	2100	2115	2130	15 (Riser) + 2130 (U)	N/A	N/A
Leather 1 N/A		Leather 2 N/A		Leather 3 N/A		Leather 4 N/A		Leather 5 N/A		Leather 6 N/A		Leather 8 N/A		COL N/A		S Nail N/A		M Nail N/A	

Fabric SKU: **4615-04-P** Leather SKU: **N/A**
 BD COLLECTION FOR FAIRFIELD
Anderson Arm Chair with Half Skirt and Pull

Standard Pillows: N/A **Finish Req:** Y
Standard Cushions: High Resiliency 40 **Standard Finish:**
COM: 4.5 yards **COL:** N/A
 Features a decorative leather handle with cream accent stitching.

Width: 24.5 **Depth:** 28.5 **Height:** 39.5
AH: 25.25 **SH:** 19.5 **SD:** 19.5 **IW:** 19.5
Weight: 25 lbs **Cube:** 21.65

D	E	F	G	H	J	K COM	L	M	N	O	P	Q	R	S	T	U	(# above U) *	S Nail	M Nail
1920	1935	1950	1965	1980	1995	2010	2025	2040	2055	2070	2085	2100	2115	2130	2145	2160	15 (Riser) + 2160 (U)	N/A	N/A
Leather 1 N/A		Leather 2 N/A		Leather 3 N/A		Leather 4 N/A		Leather 5 N/A		Leather 6 N/A		Leather 8 N/A		COL N/A		S Nail N/A		M Nail N/A	

Upholstery

**Pillows are not available on leather SKUs*

Fabric SKU: **4615-A2** Leather SKU: **N/A**

BD COLLECTION FOR FAIRFIELD

Anderson Arm Chair with Half Skirt

Standard Pillows: N/A **Finish Req:** Y

Standard Cushions: High Resiliency 40 **Standard Finish:**

COM: 4.5 yards **COL:** N/A

Width: 24.5 **Depth:** 28.5 **Height:** 39.5

AH: 25.25 **SH:** 19.5 **SD:** 19.5 **IW:** 19.5

Weight: 25 lbs **Cube:** 21.65

D	E	F	G	H	J	K COM	L	M	N	O	P	Q	R	S	T	U	(# above U) *	S Nail	M Nail
1926	1941	1956	1971	1986	2001	2016	2031	2046	2061	2076	2091	2106	2121	2136	2151	2166	15 (Riser) + 2166 (U)	N/A	N/A
Leather 1 N/A		Leather 2 N/A		Leather 3 N/A		Leather 4 N/A		Leather 5 N/A		Leather 6 N/A		Leather 8 N/A		COL N/A		S Nail N/A		M Nail N/A	

Fabric SKU: **4615-A2-P** Leather SKU: **N/A**

BD COLLECTION FOR FAIRFIELD

Anderson Arm Chair with Half Skirt and Pull

Standard Pillows: N/A **Finish Req:** Y

Standard Cushions: High Resiliency 40 **Standard Finish:**

COM: 4.5 yards **COL:** N/A

Features a decorative leather handle with cream accent stitching.

Width: 24.5 **Depth:** 28.5 **Height:** 39.5

AH: 25.25 **SH:** 19.5 **SD:** 19.5 **IW:** 19.5

Weight: 25 lbs **Cube:** 21.65

D	E	F	G	H	J	K COM	L	M	N	O	P	Q	R	S	T	U	(# above U) *	S Nail	M Nail
1956	1971	1986	2001	2016	2031	2046	2061	2076	2091	2106	2121	2136	2151	2166	2181	2196	15 (Riser) + 2196 (U)	N/A	N/A
Leather 1 N/A		Leather 2 N/A		Leather 3 N/A		Leather 4 N/A		Leather 5 N/A		Leather 6 N/A		Leather 8 N/A		COL N/A		S Nail N/A		M Nail N/A	

Fabric SKU: **4615-A4** Leather SKU: **N/A**

BD COLLECTION FOR FAIRFIELD

Anderson Arm Chair with Half Skirt

Standard Pillows: N/A **Finish Req:** Y

Standard Cushions: High Resiliency 40 **Standard Finish:**

COM: 4.5 yards **COL:** N/A

Width: 24.5 **Depth:** 28.5 **Height:** 39.5

AH: 25.25 **SH:** 19.5 **SD:** 19.5 **IW:** 19.5

Weight: 25 lbs **Cube:** 21.65

D	E	F	G	H	J	K COM	L	M	N	O	P	Q	R	S	T	U	(# above U) *	S Nail	M Nail
1962	1977	1992	2007	2022	2037	2052	2067	2082	2097	2112	2127	2142	2157	2172	2187	2202	15 (Riser) + 2202 (U)	N/A	N/A
Leather 1 N/A		Leather 2 N/A		Leather 3 N/A		Leather 4 N/A		Leather 5 N/A		Leather 6 N/A		Leather 8 N/A		COL N/A		S Nail N/A		M Nail N/A	

Fabric SKU: **4615-A4-P** Leather SKU: **N/A**

BD COLLECTION FOR FAIRFIELD

Anderson Arm Chair with Half Skirt and Pull

Standard Pillows: N/A **Finish Req:** Y

Standard Cushions: High Resiliency 40 **Standard Finish:**

COM: 4.5 yards **COL:** N/A

Features a decorative leather handle with cream accent stitching.

Width: 24.5 **Depth:** 28.5 **Height:** 39.5

AH: 25.25 **SH:** 19.5 **SD:** 19.5 **IW:** 19.5

Weight: 25 lbs **Cube:** 21.65

D	E	F	G	H	J	K COM	L	M	N	O	P	Q	R	S	T	U	(# above U) *	S Nail	M Nail
1992	2007	2022	2037	2052	2067	2082	2097	2112	2127	2142	2157	2172	2187	2202	2217	2232	15 (Riser) + 2232 (U)	N/A	N/A
Leather 1 N/A		Leather 2 N/A		Leather 3 N/A		Leather 4 N/A		Leather 5 N/A		Leather 6 N/A		Leather 8 N/A		COL N/A		S Nail N/A		M Nail N/A	

Fabric SKU: **4616-04** Leather SKU: **N/A**

BD COLLECTION FOR FAIRFIELD

Gigi Arm Chair with Half Skirt

Standard Pillows: N/A **Finish Req:** Y

Standard Cushions: High Resiliency 40 **Standard Finish:**

COM: 4 yards **COL:** N/A

Width: 27.5 **Depth:** 25 **Height:** 33.5

AH: 25.5 **SH:** 18.5 **SD:** 18.5 **IW:** 20.25

Weight: 27 lbs **Cube:** 21.65

D	E	F	G	H	J	K COM	L	M	N	O	P	Q	R	S	T	U	(# above U) *	S Nail	M Nail
2280	2292	2304	2316	2328	2340	2352	2364	2376	2388	2400	2412	2424	2436	2448	2460	2472	12 (Riser) + 2472 (U)	N/A	N/A
Leather 1 N/A		Leather 2 N/A		Leather 3 N/A		Leather 4 N/A		Leather 5 N/A		Leather 6 N/A		Leather 8 N/A		COL N/A		S Nail N/A		M Nail N/A	

Fabric SKU: **4616-A2** Leather SKU: **N/A**

BD COLLECTION FOR FAIRFIELD

Gigi Arm Chair with Half Skirt

Standard Pillows: N/A **Finish Req:** Y

Standard Cushions: High Resiliency 40 **Standard Finish:**

COM: 4 yards **COL:** N/A

Width: 27.5 **Depth:** 25 **Height:** 33.5

AH: 25.5 **SH:** 18.5 **SD:** 18.5 **IW:** 20.25

Weight: 27 lbs **Cube:** 21.65

D	E	F	G	H	J	K COM	L	M	N	O	P	Q	R	S	T	U	(# above U) *	S Nail	M Nail
2316	2328	2340	2352	2364	2376	2388	2400	2412	2424	2436	2448	2460	2472	2484	2496	2508	12 (Riser) + 2508 (U)	N/A	N/A
Leather 1 N/A		Leather 2 N/A		Leather 3 N/A		Leather 4 N/A		Leather 5 N/A		Leather 6 N/A		Leather 8 N/A		COL N/A		S Nail N/A		M Nail N/A	

Upholstery

**Pillows are not available on leather SKUs*

Fabric SKU: **4616-A4** Leather SKU: **N/A**

BD COLLECTION FOR FAIRFIELD

Gigi Arm Chair with Half Skirt

Standard Pillows: N/A **Finish Req:** Y

Standard Cushions: High Resiliency 40 **Standard Finish:**

COM: 4 yards **COL:** N/A

Width: 27.5 **Depth:** 25 **Height:** 33.5
AH: 25.5 **SH:** 18.5 **SD:** 18.5 **IW:** 20.25
Weight: 27 lbs **Cube:** 21.65

D 2352	E 2364	F 2376	G 2388	H 2400	J 2412	K COM 2424	L 2436	M 2448	N 2460	O 2472	P 2484	Q 2496	R 2508	S 2520	T 2532	U 2544	(# above U) * 12 (Riser) + 2544 (U)	S Nail N/A	M Nail N/A
Leather 1 N/A		Leather 2 N/A		Leather 3 N/A		Leather 4 N/A		Leather 5 N/A		Leather 6 N/A		Leather 8 N/A		COL N/A		S Nail N/A		M Nail N/A	

Fabric SKU: **4625-04** Leather SKU: **N/A**

BD COLLECTION FOR FAIRFIELD

Anderson Arm Chair with Full Skirt

Standard Pillows: N/A **Finish Req:** Y

Standard Cushions: High Resiliency 40 **Standard Finish:**

COM: 5.25 yards **COL:** N/A

Width: 24.5 **Depth:** 28.5 **Height:** 39.5
AH: 25.25 **SH:** 19.5 **SD:** 19.5 **IW:** 19.5
Weight: 25 lbs **Cube:** 21.65

D 1965	E 1986	F 2007	G 2028	H 2049	J 2070	K COM 2091	L 2112	M 2133	N 2154	O 2175	P 2196	Q 2217	R 2238	S 2259	T 2280	U 2301	(# above U) * 21 (Riser) + 2301 (U)	S Nail N/A	M Nail N/A
Leather 1 N/A		Leather 2 N/A		Leather 3 N/A		Leather 4 N/A		Leather 5 N/A		Leather 6 N/A		Leather 8 N/A		COL N/A		S Nail N/A		M Nail N/A	

Fabric SKU: **4625-04-P** Leather SKU: **N/A**

BD COLLECTION FOR FAIRFIELD

Anderson Arm Chair with Full Skirt and Pull

Standard Pillows: N/A **Finish Req:** Y

Standard Cushions: High Resiliency 40 **Standard Finish:**

COM: 5.25 yards **COL:** N/A

Features a decorative leather handle with cream accent stitching.

Width: 24.5 **Depth:** 28.5 **Height:** 39.5
AH: 25.25 **SH:** 19.5 **SD:** 19.5 **IW:** 19.5
Weight: 25 lbs **Cube:** 21.65

D 1995	E 2016	F 2037	G 2058	H 2079	J 2100	K COM 2121	L 2142	M 2163	N 2184	O 2205	P 2226	Q 2247	R 2268	S 2289	T 2310	U 2331	(# above U) * 21 (Riser) + 2331 (U)	S Nail N/A	M Nail N/A
Leather 1 N/A		Leather 2 N/A		Leather 3 N/A		Leather 4 N/A		Leather 5 N/A		Leather 6 N/A		Leather 8 N/A		COL N/A		S Nail N/A		M Nail N/A	

Fabric SKU: **4625-A2** Leather SKU: **N/A**

BD COLLECTION FOR FAIRFIELD

Anderson Arm Chair with Full Skirt

Standard Pillows: N/A **Finish Req:** Y

Standard Cushions: High Resiliency 40 **Standard Finish:**

COM: 5.25 yards **COL:** N/A

Width: 24.5 **Depth:** 28.5 **Height:** 39.5
AH: 25.25 **SH:** 19.5 **SD:** 19.5 **IW:** 19.5
Weight: 25 lbs **Cube:** 21.65

D 2001	E 2022	F 2043	G 2064	H 2085	J 2106	K COM 2127	L 2148	M 2169	N 2190	O 2211	P 2232	Q 2253	R 2274	S 2295	T 2316	U 2337	(# above U) * 21 (Riser) + 2337 (U)	S Nail N/A	M Nail N/A
Leather 1 N/A		Leather 2 N/A		Leather 3 N/A		Leather 4 N/A		Leather 5 N/A		Leather 6 N/A		Leather 8 N/A		COL N/A		S Nail N/A		M Nail N/A	

Fabric SKU: **4625-A2-P** Leather SKU: **N/A**

BD COLLECTION FOR FAIRFIELD

Anderson Arm Chair with Full Skirt and Pull

Standard Pillows: N/A **Finish Req:** Y

Standard Cushions: High Resiliency 40 **Standard Finish:**

COM: 5.25 yards **COL:** N/A

Features a decorative leather handle with cream accent stitching.

Width: 24.5 **Depth:** 28.5 **Height:** 39.5
AH: 25.25 **SH:** 19.5 **SD:** 19.5 **IW:** 19.5
Weight: 25 lbs **Cube:** 21.65

D 2031	E 2052	F 2073	G 2094	H 2115	J 2136	K COM 2157	L 2178	M 2199	N 2220	O 2241	P 2262	Q 2283	R 2304	S 2325	T 2346	U 2367	(# above U) * 21 (Riser) + 2367 (U)	S Nail N/A	M Nail N/A
Leather 1 N/A		Leather 2 N/A		Leather 3 N/A		Leather 4 N/A		Leather 5 N/A		Leather 6 N/A		Leather 8 N/A		COL N/A		S Nail N/A		M Nail N/A	

Fabric SKU: **4625-A4** Leather SKU: **N/A**

BD COLLECTION FOR FAIRFIELD

Anderson Arm Chair with Full Skirt

Standard Pillows: N/A **Finish Req:** Y

Standard Cushions: High Resiliency 40 **Standard Finish:**

COM: 5.25 yards **COL:** N/A

Width: 24.5 **Depth:** 28.5 **Height:** 39.5
AH: 25.25 **SH:** 19.5 **SD:** 19.5 **IW:** 19.5
Weight: 25 lbs **Cube:** 21.65

D 2037	E 2058	F 2079	G 2100	H 2121	J 2142	K COM 2163	L 2184	M 2205	N 2226	O 2247	P 2268	Q 2289	R 2310	S 2331	T 2352	U 2373	(# above U) * 21 (Riser) + 2373 (U)	S Nail N/A	M Nail N/A
Leather 1 N/A		Leather 2 N/A		Leather 3 N/A		Leather 4 N/A		Leather 5 N/A		Leather 6 N/A		Leather 8 N/A		COL N/A		S Nail N/A		M Nail N/A	

Upholstery

**Pillows are not available on leather SKUs*

Fabric SKU: **4625-A4-P** Leather SKU: **N/A**
 BD COLLECTION FOR FAIRFIELD
Anderson Arm Chair with Full Skirt and Pull

Standard Pillows: N/A **Finish Req:** Y
Standard Cushions: High Resiliency 40 **Standard Finish:**
COM: 5.25 yards **COL:** N/A
 Features a decorative leather handle with cream accent stitching.

Width: 24.5 **Depth:** 28.5 **Height:** 39.5
AH: 25.25 **SH:** 19.5 **SD:** 19.5 **IW:** 19.5
Weight: 25 lbs **Cube:** 21.65

D	E	F	G	H	J	K COM	L	M	N	O	P	Q	R	S	T	U	(# above U) *	S Nail	M Nail
2067	2088	2109	2130	2151	2172	2193	2214	2235	2256	2277	2298	2319	2340	2361	2382	2403	21 (Riser) + 2403 (U)	N/A	N/A
Leather 1 N/A		Leather 2 N/A		Leather 3 N/A		Leather 4 N/A		Leather 5 N/A		Leather 6 N/A		Leather 8 N/A		COL N/A		S Nail N/A		M Nail N/A	

Fabric SKU: **4626-04** Leather SKU: **N/A**
 BD COLLECTION FOR FAIRFIELD
Gigi Arm Chair with Full Skirt

Standard Pillows: N/A **Finish Req:** Y
Standard Cushions: High Resiliency 40 **Standard Finish:**
COM: 4.5 yards **COL:** N/A

Width: 27.5 **Depth:** 25 **Height:** 33.5
AH: 25.5 **SH:** 18.5 **SD:** 18.5 **IW:** 20.25
Weight: 27 lbs **Cube:** 21.65

D	E	F	G	H	J	K COM	L	M	N	O	P	Q	R	S	T	U	(# above U) *	S Nail	M Nail
2370	2385	2400	2415	2430	2445	2460	2475	2490	2505	2520	2535	2550	2565	2580	2595	2610	15 (Riser) + 2610 (U)	N/A	N/A
Leather 1 N/A		Leather 2 N/A		Leather 3 N/A		Leather 4 N/A		Leather 5 N/A		Leather 6 N/A		Leather 8 N/A		COL N/A		S Nail N/A		M Nail N/A	

Fabric SKU: **4626-A2** Leather SKU: **N/A**
 BD COLLECTION FOR FAIRFIELD
Gigi Arm Chair with Full Skirt

Standard Pillows: N/A **Finish Req:** Y
Standard Cushions: High Resiliency 40 **Standard Finish:**
COM: 4.5 yards **COL:** N/A

Width: 27.5 **Depth:** 25 **Height:** 33.5
AH: 25.5 **SH:** 18.5 **SD:** 18.5 **IW:** 20.25
Weight: 27 lbs **Cube:** 21.65

D	E	F	G	H	J	K COM	L	M	N	O	P	Q	R	S	T	U	(# above U) *	S Nail	M Nail
2406	2421	2436	2451	2466	2481	2496	2511	2526	2541	2556	2571	2586	2601	2616	2631	2646	15 (Riser) + 2646 (U)	N/A	N/A
Leather 1 N/A		Leather 2 N/A		Leather 3 N/A		Leather 4 N/A		Leather 5 N/A		Leather 6 N/A		Leather 8 N/A		COL N/A		S Nail N/A		M Nail N/A	

Fabric SKU: **4626-A4** Leather SKU: **N/A**
 BD COLLECTION FOR FAIRFIELD
Gigi Arm Chair with Full Skirt

Standard Pillows: N/A **Finish Req:** Y
Standard Cushions: High Resiliency 40 **Standard Finish:**
COM: 4.5 yards **COL:** N/A

Width: 27.5 **Depth:** 25 **Height:** 33.5
AH: 25.5 **SH:** 18.5 **SD:** 18.5 **IW:** 20.25
Weight: 27 lbs **Cube:** 21.65

D	E	F	G	H	J	K COM	L	M	N	O	P	Q	R	S	T	U	(# above U) *	S Nail	M Nail
2442	2457	2472	2487	2502	2517	2532	2547	2562	2577	2592	2607	2622	2637	2652	2667	2682	15 (Riser) + 2682 (U)	N/A	N/A
Leather 1 N/A		Leather 2 N/A		Leather 3 N/A		Leather 4 N/A		Leather 5 N/A		Leather 6 N/A		Leather 8 N/A		COL N/A		S Nail N/A		M Nail N/A	

Fabric SKU: **5013-04** Leather SKU: **N/A**
Portside Arm Chair

Standard Pillows: N/A **Finish Req:** N
Standard Cushions: High Resiliency 30 **Standard Finish:** Natural
COM: 1.5 yards **COL:** N/A
 Features natural cane accents that are handwoven using the peel of natural rattan. As with any natural product, nature's imperfections and hallmarks will be present in the cane materials. Cane is a handcrafted product dating back to the Ancient Egyptians.

Width: 23 **Depth:** 24.25 **Height:** 35
AH: 24.5 **SH:** 19.25 **SD:** 21.5 **IW:** 19.75
Weight: 19 lbs **Cube:** 11.29

D	E	F	G	H	J	K COM	L	M	N	O	P	Q	R	S	T	U	(# above U) *	S Nail	M Nail
1875	1881	1887	1893	1899	1905	1911	1917	1923	1929	1935	1941	1947	1953	1959	1965	1971	6 (Riser) + 1971 (U)	N/A	N/A
Leather 1 N/A		Leather 2 N/A		Leather 3 N/A		Leather 4 N/A		Leather 5 N/A		Leather 6 N/A		Leather 8 N/A		COL N/A		S Nail N/A		M Nail N/A	

Fabric SKU: **5013-05** Leather SKU: **N/A**
Portside Side Chair

Standard Pillows: N/A **Finish Req:** N
Standard Cushions: High Resiliency 30 **Standard Finish:** Natural
COM: 1.5 yards **COL:** N/A
 Features natural cane accents that are handwoven using the peel of natural rattan. As with any natural product, nature's imperfections and hallmarks will be present in the cane materials. Cane is a handcrafted product dating back to the Ancient Egyptians.

Width: 21 **Depth:** 24.5 **Height:** 35
AH: 0 **SH:** 19 **SD:** 21.5 **IW:** 21
Weight: 16 lbs **Cube:** 10.42

D	E	F	G	H	J	K COM	L	M	N	O	P	Q	R	S	T	U	(# above U) *	S Nail	M Nail
1845	1851	1857	1863	1869	1875	1881	1887	1893	1899	1905	1911	1917	1923	1929	1935	1941	6 (Riser) + 1941 (U)	N/A	N/A
Leather 1 N/A		Leather 2 N/A		Leather 3 N/A		Leather 4 N/A		Leather 5 N/A		Leather 6 N/A		Leather 8 N/A		COL N/A		S Nail N/A		M Nail N/A	

Upholstery

**Pillows are not available on leather SKUs*

Fabric SKU: **5026-05**

Leather SKU: **L-5026-05**

Standard Pillows: N/A Finish Req: Y

Standard Cushions: High Resiliency 40 Standard Finish:

COM: 2.25 yards COL: 45 square feet

Darien Side Chair

Width: 21 Depth: 24.5 Height: 34

AH: 0 SH: 20 SD: 19.5 IW: 21

Weight: 25 lbs Cube: 15.74

D	E	F	G	H	J	K COM	L	M	N	O	P	Q	R	S	T	U	(# above U) *	S Nail	M Nail
1350	1359	1368	1377	1386	1395	1404	1413	1422	1431	1440	1449	1458	1467	1476	1485	1494	9 (Riser) + 1494 (U)	45	N/A
Leather 1 1995		Leather 2 2070		Leather 3 2145		Leather 4 2220		Leather 5 2295		Leather 6 2370		Leather 8 3000		COL 1422		S Nail 45		M Nail N/A	

Fabric SKU: **5026-07**

Leather SKU: **L-5026-07**

Standard Pillows: N/A Finish Req: Y

Standard Cushions: High Resiliency 40 Standard Finish:

COM: 2.5 yards COL: 45 square feet

Darien Bar Stool

Width: 21 Depth: 24.5 Height: 44.5

AH: 0 SH: 30.5 SD: 19.5 IW: 21

Weight: 22 lbs Cube: 17.77

D	E	F	G	H	J	K COM	L	M	N	O	P	Q	R	S	T	U	(# above U) *	S Nail	M Nail
1440	1449	1458	1467	1476	1485	1494	1503	1512	1521	1530	1539	1548	1557	1566	1575	1584	9 (Riser) + 1584 (U)	45	N/A
Leather 1 2085		Leather 2 2160		Leather 3 2235		Leather 4 2310		Leather 5 2385		Leather 6 2460		Leather 8 3090		COL 1512		S Nail 45		M Nail N/A	

Fabric SKU: **5026-C7**

Leather SKU: **L-5026-C7**

Standard Pillows: N/A Finish Req: Y

Standard Cushions: High Resiliency 40 Standard Finish:

COM: 2.5 yards COL: 45 square feet

Darien Counter Stool

Width: 21 Depth: 24.5 Height: 40.5

AH: 0 SH: 26.5 SD: 19.5 IW: 21

Weight: 22 lbs Cube: 19.6

D	E	F	G	H	J	K COM	L	M	N	O	P	Q	R	S	T	U	(# above U) *	S Nail	M Nail
1440	1449	1458	1467	1476	1485	1494	1503	1512	1521	1530	1539	1548	1557	1566	1575	1584	9 (Riser) + 1584 (U)	45	N/A
Leather 1 2085		Leather 2 2160		Leather 3 2235		Leather 4 2310		Leather 5 2385		Leather 6 2460		Leather 8 3090		COL 1512		S Nail 45		M Nail N/A	

Fabric SKU: **5026-S4**

Leather SKU: **L-5026-S4**

Standard Pillows: N/A Finish Req: Y

Standard Cushions: High Resiliency 40 Standard Finish:

COM: 2.5 yards COL: 43.2 square feet

Darien Side Chair with four casters

Width: 21 Depth: 24.5 Height: 34

AH: 0 SH: 20 SD: 19.5 IW: 21

Weight: 25 lbs Cube: 15.74

D	E	F	G	H	J	K COM	L	M	N	O	P	Q	R	S	T	U	(# above U) *	S Nail	M Nail
1422	1431	1440	1449	1458	1467	1476	1485	1494	1503	1512	1521	1530	1539	1548	1557	1566	9 (Riser) + 1566 (U)	45	N/A
Leather 1 2085		Leather 2 2160		Leather 3 2235		Leather 4 2310		Leather 5 2385		Leather 6 2460		Leather 8 3060		COL 1494		S Nail 45		M Nail N/A	

Fabric SKU: **5035-07**

Leather SKU: **L-5035-07**

Standard Pillows: N/A Finish Req: Y

Standard Cushions: High Resiliency 40 Standard Finish:

COM: 2 yards COL: 40 square feet

Orleans Bar Stool

Width: 19 Depth: 20 Height: 41.5

AH: 0 SH: 29.5 SD: 18 IW: 19

Weight: 30 lbs Cube: 17.77

D	E	F	G	H	J	K COM	L	M	N	O	P	Q	R	S	T	U	(# above U) *	S Nail	M Nail
1320	1326	1332	1338	1344	1350	1356	1362	1368	1374	1380	1386	1392	1398	1404	1410	1416	6 (Riser) + 1416 (U)	45	N/A
Leather 1 1815		Leather 2 1875		Leather 3 1935		Leather 4 1995		Leather 5 2055		Leather 6 2115		Leather 8 2670		COL 1368		S Nail 45		M Nail N/A	

Fabric SKU: **5035-C7**

Leather SKU: **L-5035-C7**

Standard Pillows: N/A Finish Req: Y

Standard Cushions: High Resiliency 40 Standard Finish:

COM: 2 yards COL: 40 square feet

Orleans Counter Stool

Width: 19 Depth: 20 Height: 37.5

AH: 0 SH: 25.5 SD: 18 IW: 19

Weight: 30 lbs Cube: 15.74

D	E	F	G	H	J	K COM	L	M	N	O	P	Q	R	S	T	U	(# above U) *	S Nail	M Nail
1320	1326	1332	1338	1344	1350	1356	1362	1368	1374	1380	1386	1392	1398	1404	1410	1416	6 (Riser) + 1416 (U)	45	N/A
Leather 1 1815		Leather 2 1875		Leather 3 1935		Leather 4 1995		Leather 5 2055		Leather 6 2115		Leather 8 2670		COL 1368		S Nail 45		M Nail N/A	

Upholstery

**Pillows are not available on leather SKUs*

Fabric SKU: 5049-04

Leather SKU: L-5049-04

Standard Pillows: N/A Finish Req: Y

Standard Cushions: High Resiliency 40 Standard Finish:

COM: 2.25 yards COL: 40 square feet

Dilworth Arm Chair

Width: 22.5 Depth: 23.5 Height: 35.5

AH: 25.5 SH: 19 SD: 19.5 IW: 19

Weight: 30 lbs Cube: 15.74

D	E	F	G	H	J	K COM	L	M	N	O	P	Q	R	S	T	U	(# above U) *	S Nail	M Nail
1350	1356	1362	1368	1374	1380	1386	1392	1398	1404	1410	1416	1422	1428	1434	1440	1446	6 (Riser) + 1446 (U)	45	60
Leather 1 1980		Leather 2 2040		Leather 3 2100		Leather 4 2160		Leather 5 2220		Leather 6 2280		Leather 8 2835		COL 1398		S Nail 45		M Nail 60	

Fabric SKU: 5049-05

Leather SKU: L-5049-05

Standard Pillows: N/A Finish Req: Y

Standard Cushions: High Resiliency 40 Standard Finish:

COM: 2 yards COL: 40 square feet

Dilworth Side Chair

Width: 19 Depth: 23 Height: 35.5

AH: 0 SH: 19 SD: 19 IW: 19

Weight: 20 lbs Cube: 15.74

D	E	F	G	H	J	K COM	L	M	N	O	P	Q	R	S	T	U	(# above U) *	S Nail	M Nail
1320	1326	1332	1338	1344	1350	1356	1362	1368	1374	1380	1386	1392	1398	1404	1410	1416	6 (Riser) + 1416 (U)	45	60
Leather 1 1860		Leather 2 1920		Leather 3 1980		Leather 4 2040		Leather 5 2100		Leather 6 2160		Leather 8 2715		COL 1368		S Nail 45		M Nail 60	

Fabric SKU: 5049-07

Leather SKU: L-5049-07

Standard Pillows: N/A Finish Req: Y

Standard Cushions: High Resiliency 40 Standard Finish:

COM: 2 yards COL: 40 square feet

Dilworth Bar Stool

Width: 19.5 Depth: 22 Height: 41

AH: 0 SH: 30 SD: 19 IW: 19.5

Weight: 22 lbs Cube: 15.74

D	E	F	G	H	J	K COM	L	M	N	O	P	Q	R	S	T	U	(# above U) *	S Nail	M Nail
1455	1461	1467	1473	1479	1485	1491	1497	1503	1509	1515	1521	1527	1533	1539	1545	1551	6 (Riser) + 1551 (U)	45	60
Leather 1 1980		Leather 2 2040		Leather 3 2100		Leather 4 2160		Leather 5 2220		Leather 6 2280		Leather 8 2835		COL 1503		S Nail 45		M Nail 60	

Fabric SKU: 5049-A4

Leather SKU: L-5049-A4

Standard Pillows: N/A Finish Req: Y

Standard Cushions: High Resiliency 40 Standard Finish:

COM: 2.25 yards COL: 40 square feet

Dilworth Arm Chair

Width: 22.5 Depth: 23.5 Height: 35.5

AH: 25.5 SH: 19 SD: 19.5 IW: 19

Weight: 30 lbs Cube: 15.74

D	E	F	G	H	J	K COM	L	M	N	O	P	Q	R	S	T	U	(# above U) *	S Nail	M Nail
1422	1428	1434	1440	1446	1452	1458	1464	1470	1476	1482	1488	1494	1500	1506	1512	1518	6 (Riser) + 1518 (U)	45	60
Leather 1 2055		Leather 2 2115		Leather 3 2175		Leather 4 2235		Leather 5 2295		Leather 6 2355		Leather 8 2910		COL 1470		S Nail 45		M Nail 60	

Fabric SKU: 5049-C7

Leather SKU: L-5049-C7

Standard Pillows: N/A Finish Req: Y

Standard Cushions: High Resiliency 40 Standard Finish:

COM: 2 yards COL: 40 square feet

Dilworth Counter Stool

Width: 19.5 Depth: 22 Height: 37

AH: 0 SH: 26 SD: 19 IW: 19.5

Weight: 21 lbs Cube: 15.74

D	E	F	G	H	J	K COM	L	M	N	O	P	Q	R	S	T	U	(# above U) *	S Nail	M Nail
1455	1461	1467	1473	1479	1485	1491	1497	1503	1509	1515	1521	1527	1533	1539	1545	1551	6 (Riser) + 1551 (U)	45	60
Leather 1 1980		Leather 2 2040		Leather 3 2100		Leather 4 2160		Leather 5 2220		Leather 6 2280		Leather 8 2835		COL 1503		S Nail 45		M Nail 60	

Fabric SKU: 5072-05

Leather SKU: L-5072-05

Standard Pillows: N/A Finish Req: Y

Standard Cushions: High Resiliency 40 Standard Finish:

COM: 2.75 yards COL: 51 square feet

Gavin Side Chair

Width: 22 Depth: 24.5 Height: 36

AH: 0 SH: 18 SD: 19.5 IW: 20

Weight: 23 lbs Cube: 15.74

D	E	F	G	H	J	K COM	L	M	N	O	P	Q	R	S	T	U	(# above U) *	S Nail	M Nail
1500	1509	1518	1527	1536	1545	1554	1563	1572	1581	1590	1599	1608	1617	1626	1635	1644	9 (Riser) + 1644 (U)	45	N/A
Leather 1 2220		Leather 2 2295		Leather 3 2370		Leather 4 2445		Leather 5 2520		Leather 6 2595		Leather 8 3300		COL 1572		S Nail 45		M Nail N/A	

Upholstery

**Pillows are not available on leather SKUs*

Fabric SKU: **5094-07**

Leather SKU: **L-5094-07**

Standard Pillows: N/A Finish Req: Y

Standard Cushions: High Resiliency 40 Standard Finish:

COM: 2.25 yards COL: 40 square feet

Roxanne Bar Stool

Width: 20 Depth: 21 Height: 42.5

AH: 0 SH: 30 SD: 16 IW: 20

Weight: 22 lbs Cube: 17.77

D	E	F	G	H	J	K COM	L	M	N	O	P	Q	R	S	T	U	(# above U) *	S Nail	M Nail
1305	1311	1317	1323	1329	1335	1341	1347	1353	1359	1365	1371	1377	1383	1389	1395	1401	6 (Riser) + 1401 (U)	45	N/A
Leather 1 1815		Leather 2 1875		Leather 3 1935		Leather 4 1995		Leather 5 2055		Leather 6 2115		Leather 8 2670		COL 1353		S Nail 45		M Nail N/A	

Fabric SKU: **5094-C7**

Leather SKU: **L-5094-C7**

Standard Pillows: N/A Finish Req: Y

Standard Cushions: High Resiliency 40 Standard Finish:

COM: 2.25 yards COL: 40 square feet

Roxanne Counter Stool

Width: 20 Depth: 21 Height: 38.5

AH: 0 SH: 26.5 SD: 16 IW: 20

Weight: 22 lbs Cube: 15.74

D	E	F	G	H	J	K COM	L	M	N	O	P	Q	R	S	T	U	(# above U) *	S Nail	M Nail
1305	1311	1317	1323	1329	1335	1341	1347	1353	1359	1365	1371	1377	1383	1389	1395	1401	6 (Riser) + 1401 (U)	45	N/A
Leather 1 1815		Leather 2 1875		Leather 3 1935		Leather 4 1995		Leather 5 2055		Leather 6 2115		Leather 8 2670		COL 1353		S Nail 45		M Nail N/A	

Fabric SKU: **5095-C6**

Leather SKU: **L-5095-C6**

Standard Pillows: N/A Finish Req: Y

Standard Cushions: High Resiliency 40 Standard Finish:

COM: 1.75 yards COL: 34 square feet

Ramsey Counter Stool

Width: 22 Depth: 21.5 Height: 38.5

AH: 29.5 SH: 24 SD: 17.5 IW: 18

Weight: 30 lbs Cube: 15.74

D	E	F	G	H	J	K COM	L	M	N	O	P	Q	R	S	T	U	(# above U) *	S Nail	M Nail
1260	1266	1272	1278	1284	1290	1296	1302	1308	1314	1320	1326	1332	1338	1344	1350	1356	6 (Riser) + 1356 (U)	45	60
Leather 1 1635		Leather 2 1695		Leather 3 1755		Leather 4 1815		Leather 5 1875		Leather 6 1935		Leather 8 2400		COL 1308		S Nail 45		M Nail 60	

Fabric SKU: **5103-01**

Leather SKU: **L-5103-01**

Standard Pillows: (1) 23-1/2 x 15-1/2 Kidney Finish Req: Y

Standard Cushions: Ultra Plush Standard Finish:

COM: 7.75 yards COL: 124 square feet

Taylor Wing Chair

Width: 32 Depth: 36.5 Height: 44.5

AH: 25 SH: 21 SD: 22 IW: 24

Weight: 65 lbs Cube: 34.38

D	E	F	G	H	J	K COM	L	M	N	O	P	Q	R	S	T	U	(# above U) *	S Nail	M Nail
2475	2499	2523	2547	2571	2595	2619	2643	2667	2691	2715	2739	2763	2787	2811	2835	2859	24 (Riser) + 2859 (U)	150	N/A
Leather 1 3885		Leather 2 4080		Leather 3 4275		Leather 4 4470		Leather 5 4665		Leather 6 4860		Leather 8 6570		COL 2667		S Nail 150		M Nail N/A	

Fabric SKU: **5103-31**

Leather SKU: **L-5103-31**

Standard Pillows: (1) 23-1/2 x 15-1/2 Kidney Finish Req: N

Standard Cushions: Ultra Plush Standard Finish:

COM: 7.75 yards COL: 124 square feet

Taylor Swivel Chair

Width: 31.5 Depth: 34.75 Height: 41

AH: 22.5 SH: 18.5 SD: 22 IW: 24

Weight: 65 lbs Cube: 34.3

D	E	F	G	H	J	K COM	L	M	N	O	P	Q	R	S	T	U	(# above U) *	S Nail	M Nail
2475	2499	2523	2547	2571	2595	2619	2643	2667	2691	2715	2739	2763	2787	2811	2835	2859	24 (Riser) + 2859 (U)	150	N/A
Leather 1 3960		Leather 2 4155		Leather 3 4350		Leather 4 4545		Leather 5 4740		Leather 6 4935		Leather 8 6645		COL 2667		S Nail 150		M Nail N/A	

Fabric SKU: **5103-32**

Leather SKU: **L-5103-32**

Standard Pillows: (1) 23-1/2 x 15-1/2 Kidney Finish Req: N

Standard Cushions: Ultra Plush Standard Finish:

COM: 7.75 yards COL: 124 square feet

Taylor Swivel Glider

Width: 32 Depth: 36.5 Height: 44.5

AH: 25 SH: 21 SD: 22 IW: 24

Weight: 65 lbs Cube: 34.3

D	E	F	G	H	J	K COM	L	M	N	O	P	Q	R	S	T	U	(# above U) *	S Nail	M Nail
2625	2649	2673	2697	2721	2745	2769	2793	2817	2841	2865	2889	2913	2937	2961	2985	3009	24 (Riser) + 3009 (U)	150	N/A
Leather 1 4125		Leather 2 4320		Leather 3 4515		Leather 4 4710		Leather 5 4905		Leather 6 5100		Leather 8 6810		COL 2817		S Nail 150		M Nail N/A	

Upholstery

**Pillows are not available on leather SKUs*

Fabric SKU: 5108-01

Leather SKU: L-5108-01

Standard Pillows: (1) 20 x 20 Finish Req: Y

Standard Cushions: Ultra Plush Standard Finish:

COM: 8 yards COL: 141 square feet

Landon Wing Chair

Width: 34 Depth: 38 Height: 40

AH: 23 SH: 20.5 SD: 20.5 IW: 24

Weight: 61 lbs Cube: 41.32

D	E	F	G	H	J	K COM	L	M	N	O	P	Q	R	S	T	U	(# above U) *	S Nail	M Nail
2550	2574	2598	2622	2646	2670	2694	2718	2742	2766	2790	2814	2838	2862	2886	2910	2934	24 (Riser) + 2934 (U)	90	105
Leather 1 4275		Leather 2 4485		Leather 3 4695		Leather 4 4905		Leather 5 5115		Leather 6 5325		Leather 8 7275		COL 2742		S Nail 90		M Nail 105	

Fabric SKU: 5108-20

Leather SKU: L-5108-20

Standard Pillows: N/A Finish Req: Y

Standard Cushions: High Resiliency 30 Standard Finish:

COM: 2.5 yards COL: 45 square feet

Landon Ottoman

Width: 25 Depth: 19 Height: 19

AH: 0 SH: 0 SD: 0 IW: 0

Weight: 19 lbs Cube: 10.77

D	E	F	G	H	J	K COM	L	M	N	O	P	Q	R	S	T	U	(# above U) *	S Nail	M Nail
1050	1059	1068	1077	1086	1095	1104	1113	1122	1131	1140	1149	1158	1167	1176	1185	1194	9 (Riser) + 1194 (U)	30	45
Leather 1 1680		Leather 2 1755		Leather 3 1830		Leather 4 1905		Leather 5 1980		Leather 6 2055		Leather 8 2685		COL 1122		S Nail 30		M Nail 45	

Fabric SKU: 5111-01

Leather SKU: L-5111-01

Standard Pillows: N/A Finish Req: Y

Standard Cushions: Ultra Plush Standard Finish:

COM: 6.5 yards COL: 119 square feet

Constantine Wing Chair

Width: 31.75 Depth: 37 Height: 44

AH: 25.5 SH: 20 SD: 21.5 IW: 22.5

Weight: 62 lbs Cube: 36.49

D	E	F	G	H	J	K COM	L	M	N	O	P	Q	R	S	T	U	(# above U) *	S Nail	M Nail
2730	2748	2766	2784	2802	2820	2838	2856	2874	2892	2910	2928	2946	2964	2982	3000	3018	18 (Riser) + 3018 (U)	Std.	45
Leather 1 4215		Leather 2 4395		Leather 3 4575		Leather 4 4755		Leather 5 4935		Leather 6 5115		Leather 8 6750		COL 2874		S Nail Std.		M Nail 45	

Fabric SKU: 5115-01

Leather SKU: N/A

Standard Pillows: N/A Finish Req: Y

Standard Cushions: High Resiliency 30 Standard Finish:

COM: 3.75 yards COL: N/A

Marcel Wing Chair

Width: 27.25 Depth: 30.5 Height: 42

AH: 25 SH: 18.5 SD: 20 IW: 23

Weight: 39 lbs Cube: 27.3

D	E	F	G	H	J	K COM	L	M	N	O	P	Q	R	S	T	U	(# above U) *	S Nail	M Nail
2430	2442	2454	2466	2478	2490	2502	2514	2526	2538	2550	2562	2574	2586	2598	2610	2622	12 (Riser) + 2622 (U)	60	N/A
Leather 1 N/A		Leather 2 N/A		Leather 3 N/A		Leather 4 N/A		Leather 5 N/A		Leather 6 N/A		Leather 8 N/A		COL N/A		S Nail N/A		M Nail N/A	

Fabric SKU: 5134-01

Leather SKU: N/A

Standard Pillows: N/A Finish Req: Y

Standard Cushions: High Resiliency 40 Standard Finish:

COM: 5 yards COL: N/A

Frances Wing Chair

Width: 28.25 Depth: 35.5 Height: 44.5

AH: 21.5 SH: 18 SD: 21 IW: 22

Weight: 50 lbs Cube: 34.38

D	E	F	G	H	J	K COM	L	M	N	O	P	Q	R	S	T	U	(# above U) *	S Nail	M Nail
2355	2370	2385	2400	2415	2430	2445	2460	2475	2490	2505	2520	2535	2550	2565	2580	2595	15 (Riser) + 2595 (U)	Std.	N/A
Leather 1 N/A		Leather 2 N/A		Leather 3 N/A		Leather 4 N/A		Leather 5 N/A		Leather 6 N/A		Leather 8 N/A		COL N/A		S Nail N/A		M Nail N/A	

Fabric SKU: 5135-01

Leather SKU: N/A

Standard Pillows: N/A Finish Req: Y

Standard Cushions: Ultra Plush Standard Finish:

COM: 5.25 yards COL: N/A

Casper Wing Chair

Width: 33 Depth: 32.5 Height: 42

AH: 21.5 SH: 20 SD: 21.5 IW: 21.5

Weight: 60 lbs Cube: 29.29

D	E	F	G	H	J	K COM	L	M	N	O	P	Q	R	S	T	U	(# above U) *	S Nail	M Nail
2340	2355	2370	2385	2400	2415	2430	2445	2460	2475	2490	2505	2520	2535	2550	2565	2580	15 (Riser) + 2580 (U)	75	90
Leather 1 N/A		Leather 2 N/A		Leather 3 N/A		Leather 4 N/A		Leather 5 N/A		Leather 6 N/A		Leather 8 N/A		COL N/A		S Nail N/A		M Nail N/A	

Upholstery

**Pillows are not available on leather SKUs*

Fabric SKU: 5136-01

Leather SKU: N/A

Standard Pillows: N/A Finish Req: N

Standard Cushions: Ultra Plush Standard Finish:

COM: 5.25 yards COL: N/A

Casper Wing Chair

Width: 33 Depth: 32.5 Height: 42
 AH: 21.5 SH: 20 SD: 21.5 IW: 21.5
 Weight: 60 lbs Cube: 34.38

D	E	F	G	H	J	K COM	L	M	N	O	P	Q	R	S	T	U	(# above U) *	S Nail	M Nail
2400	2415	2430	2445	2460	2475	2490	2505	2520	2535	2550	2565	2580	2595	2610	2625	2640	15 (Riser) + 2640 (U)	75	90
Leather 1 N/A		Leather 2 N/A		Leather 3 N/A		Leather 4 N/A		Leather 5 N/A		Leather 6 N/A		Leather 8 N/A		COL N/A		S Nail N/A		M Nail N/A	

Fabric SKU: 5138-01

Leather SKU: N/A

Standard Pillows: N/A Finish Req: Y

Standard Cushions: Ultra Plush Standard Finish:

COM: 7.5 yards COL: N/A

Walker Wing Chair

Width: 29.5 Depth: 33 Height: 43
 AH: 22.5 SH: 19 SD: 22 IW: 21.5
 Weight: 65 lbs Cube: 33.92

D	E	F	G	H	J	K COM	L	M	N	O	P	Q	R	S	T	U	(# above U) *	S Nail	M Nail
2370	2391	2412	2433	2454	2475	2496	2517	2538	2559	2580	2601	2622	2643	2664	2685	2706	21 (Riser) + 2706 (U)	105	120
Leather 1 N/A		Leather 2 N/A		Leather 3 N/A		Leather 4 N/A		Leather 5 N/A		Leather 6 N/A		Leather 8 N/A		COL N/A		S Nail N/A		M Nail N/A	

Fabric SKU: 5145-01

Leather SKU: N/A

Standard Pillows: N/A Finish Req: Y

Standard Cushions: Ultra Plush Standard Finish:

COM: 6.25 yards COL: N/A

Also Available with buttons on Inback: 5146-01

Yates Wing Chair

Width: 28 Depth: 35 Height: 43.5
 AH: 26 SH: 21 SD: 22.5 IW: 21
 Weight: 65 lbs Cube: 33.92

D	E	F	G	H	J	K COM	L	M	N	O	P	Q	R	S	T	U	(# above U) *	S Nail	M Nail
2295	2313	2331	2349	2367	2385	2403	2421	2439	2457	2475	2493	2511	2529	2547	2565	2583	18 (Riser) + 2583 (U)	N/A	N/A
Leather 1 N/A		Leather 2 N/A		Leather 3 N/A		Leather 4 N/A		Leather 5 N/A		Leather 6 N/A		Leather 8 N/A		COL N/A		S Nail N/A		M Nail N/A	

Fabric SKU: 5145-20

Leather SKU: N/A

Standard Pillows: N/A Finish Req: Y

Standard Cushions: High Resiliency 30 Standard Finish:

COM: 2.5 yards COL: N/A

Yates Ottoman

Width: 24.5 Depth: 19 Height: 20
 AH: 0 SH: 0 SD: 0 IW: 0
 Weight: 25 lbs Cube: 10.77

D	E	F	G	H	J	K COM	L	M	N	O	P	Q	R	S	T	U	(# above U) *	S Nail	M Nail
1125	1134	1143	1152	1161	1170	1179	1188	1197	1206	1215	1224	1233	1242	1251	1260	1269	9 (Riser) + 1269 (U)	N/A	N/A
Leather 1 N/A		Leather 2 N/A		Leather 3 N/A		Leather 4 N/A		Leather 5 N/A		Leather 6 N/A		Leather 8 N/A		COL N/A		S Nail N/A		M Nail N/A	

Fabric SKU: 5146-01

Leather SKU: N/A

Standard Pillows: N/A Finish Req: Y

Standard Cushions: Ultra Plush Standard Finish:

COM: 6.25 yards COL: N/A

Also Available without Buttons: 5147-01

Austin Wing Chair

Width: 28 Depth: 35 Height: 43.5
 AH: 26 SH: 21 SD: 22.5 IW: 21
 Weight: 65 lbs Cube: 33.92

D	E	F	G	H	J	K COM	L	M	N	O	P	Q	R	S	T	U	(# above U) *	S Nail	M Nail
2295	2313	2331	2349	2367	2385	2403	2421	2439	2457	2475	2493	2511	2529	2547	2565	2583	18 (Riser) + 2583 (U)	75	90
Leather 1 N/A		Leather 2 N/A		Leather 3 N/A		Leather 4 N/A		Leather 5 N/A		Leather 6 N/A		Leather 8 N/A		COL N/A		S Nail N/A		M Nail N/A	

Fabric SKU: 5146-20

Leather SKU: N/A

Standard Pillows: N/A Finish Req: Y

Standard Cushions: High Resiliency 30 Standard Finish:

COM: 2.5 yards COL: N/A

Austin Ottoman

Width: 25 Depth: 20 Height: 19.5
 AH: 0 SH: 0 SD: 0 IW: 0
 Weight: 25 lbs Cube: 10.77

D	E	F	G	H	J	K COM	L	M	N	O	P	Q	R	S	T	U	(# above U) *	S Nail	M Nail
1125	1134	1143	1152	1161	1170	1179	1188	1197	1206	1215	1224	1233	1242	1251	1260	1269	9 (Riser) + 1269 (U)	30	45
Leather 1 N/A		Leather 2 N/A		Leather 3 N/A		Leather 4 N/A		Leather 5 N/A		Leather 6 N/A		Leather 8 N/A		COL N/A		S Nail N/A		M Nail N/A	

Upholstery

**Pillows are not available on leather SKUs*

Fabric SKU: 5147-01

Leather SKU: N/A

Standard Pillows: N/A Finish Req: Y

Standard Cushions: Ultra Plush Standard Finish:

COM: 6.25 yards COL: N/A

Also Available with buttons on Inback: 5146-01

Andrew Wing Chair

Width: 28 Depth: 35 Height: 43.5

AH: 26 SH: 21 SD: 22.5 IW: 21

Weight: 65 lbs Cube: 34.38

D	E	F	G	H	J	K COM	L	M	N	O	P	Q	R	S	T	U	(# above U) *	S Nail	M Nail
2430	2448	2466	2484	2502	2520	2538	2556	2574	2592	2610	2628	2646	2664	2682	2700	2718	18 (Riser) + 2718 (U)	Std.	15
Leather 1 N/A		Leather 2 N/A		Leather 3 N/A		Leather 4 N/A		Leather 5 N/A		Leather 6 N/A		Leather 8 N/A		COL N/A		S Nail N/A		M Nail N/A	

Fabric SKU: 5147-20

Leather SKU: N/A

Standard Pillows: N/A Finish Req: Y

Standard Cushions: High Resiliency 30 Standard Finish:

COM: 2.5 yards COL: N/A

Andrew Ottoman

Width: 24.5 Depth: 19 Height: 20

AH: 0 SH: 0 SD: 0 IW: 0

Weight: 25 lbs Cube: 10.77

D	E	F	G	H	J	K COM	L	M	N	O	P	Q	R	S	T	U	(# above U) *	S Nail	M Nail
1125	1134	1143	1152	1161	1170	1179	1188	1197	1206	1215	1224	1233	1242	1251	1260	1269	9 (Riser) + 1269 (U)	Std.	15
Leather 1 N/A		Leather 2 N/A		Leather 3 N/A		Leather 4 N/A		Leather 5 N/A		Leather 6 N/A		Leather 8 N/A		COL N/A		S Nail N/A		M Nail N/A	

Fabric SKU: 5158-01

Leather SKU: N/A

Standard Pillows: N/A Finish Req: Y

Standard Cushions: High Resiliency 20 Standard Finish:

COM: 4.75 yards COL: N/A

Downey Wing Chair

Width: 29.5 Depth: 33 Height: 41.5

AH: 24.5 SH: 20 SD: 21.5 IW: 22.5

Weight: 55 lbs Cube: 34.38

D	E	F	G	H	J	K COM	L	M	N	O	P	Q	R	S	T	U	(# above U) *	S Nail	M Nail
2265	2280	2295	2310	2325	2340	2355	2370	2385	2400	2415	2430	2445	2460	2475	2490	2505	15 (Riser) + 2505 (U)	N/A	N/A
Leather 1 N/A		Leather 2 N/A		Leather 3 N/A		Leather 4 N/A		Leather 5 N/A		Leather 6 N/A		Leather 8 N/A		COL N/A		S Nail N/A		M Nail N/A	

Fabric SKU: 5167-01

Leather SKU: N/A

Standard Pillows: N/A Finish Req: Y

Standard Cushions: Ultra Plush Standard Finish:

COM: 6.5 yards COL: N/A

Tavia Wing Chair

Width: 31.5 Depth: 37 Height: 42.5

AH: 25 SH: 20 SD: 22 IW: 25

Weight: 60 lbs Cube: 41.32

D	E	F	G	H	J	K COM	L	M	N	O	P	Q	R	S	T	U	(# above U) *	S Nail	M Nail
2775	2793	2811	2829	2847	2865	2883	2901	2919	2937	2955	2973	2991	3009	3027	3045	3063	18 (Riser) + 3063 (U)	Std.	30
Leather 1 N/A		Leather 2 N/A		Leather 3 N/A		Leather 4 N/A		Leather 5 N/A		Leather 6 N/A		Leather 8 N/A		COL N/A		S Nail N/A		M Nail N/A	

Fabric SKU: 5178-01

Leather SKU: L-5178-01

Standard Pillows: N/A Finish Req: Y

Standard Cushions: Ultra Plush Standard Finish:

COM: 6 yards COL: 113 square feet

Downing Wing Chair

Width: 29.5 Depth: 35.5 Height: 46

AH: 23 SH: 20.5 SD: 23 IW: 21

Weight: 59 lbs Cube: 34.38

D	E	F	G	H	J	K COM	L	M	N	O	P	Q	R	S	T	U	(# above U) *	S Nail	M Nail
2475	2493	2511	2529	2547	2565	2583	2601	2619	2637	2655	2673	2691	2709	2727	2745	2763	18 (Riser) + 2763 (U)	135	150
Leather 1 4005		Leather 2 4185		Leather 3 4365		Leather 4 4545		Leather 5 4725		Leather 6 4905		Leather 8 6465		COL 2619		S Nail 135		M Nail 150	

Fabric SKU: 5183-01

Leather SKU: N/A

Standard Pillows: N/A Finish Req: Y

Standard Cushions: Ultra Plush Standard Finish:

COM: 6.25 yards COL: N/A

Baird Wing Chair

Width: 34 Depth: 35 Height: 40.5

AH: 21.5 SH: 21.5 SD: 18 IW: 28

Weight: 65 lbs Cube: 33.92

D	E	F	G	H	J	K COM	L	M	N	O	P	Q	R	S	T	U	(# above U) *	S Nail	M Nail
3075	3093	3111	3129	3147	3165	3183	3201	3219	3237	3255	3273	3291	3309	3327	3345	3363	18 (Riser) + 3363 (U)	45	60
Leather 1 N/A		Leather 2 N/A		Leather 3 N/A		Leather 4 N/A		Leather 5 N/A		Leather 6 N/A		Leather 8 N/A		COL N/A		S Nail N/A		M Nail N/A	

Upholstery

**Pillows are not available on leather SKUs*

Fabric SKU: 5187-20

Leather SKU: N/A

Standard Pillows: N/A Finish Req: Y

Standard Cushions: High Resiliency 20 Standard Finish:

COM: 2.5 yards COL: N/A

Johnson Ottoman

Width: 25 Depth: 19 Height: 20

AH: 0 SH: 20 SD: 0 IW: 0

Weight: 25 lbs Cube: 10.77

D	E	F	G	H	J	K COM	L	M	N	O	P	Q	R	S	T	U	(# above U) *	S Nail	M Nail
1125	1134	1143	1152	1161	1170	1179	1188	1197	1206	1215	1224	1233	1242	1251	1260	1269	9 (Riser) + 1269 (U)	30	45
Leather 1 N/A		Leather 2 N/A		Leather 3 N/A		Leather 4 N/A		Leather 5 N/A		Leather 6 N/A		Leather 8 N/A		COL N/A		S Nail N/A		M Nail N/A	

Fabric SKU: 5191-01

Leather SKU: N/A

Standard Pillows: N/A Finish Req: N

Standard Cushions: Ultra Plush Standard Finish: Traditional

COM: 9.25 yards COL: N/A

Kimball Lounge Chair

Width: 30.5 Depth: 36 Height: 43.5

AH: 22.5 SH: 20 SD: 21 IW: 24

Weight: 65 lbs Cube: 36.49

D	E	F	G	H	J	K COM	L	M	N	O	P	Q	R	S	T	U	(# above U) *	S Nail	M Nail
2925	2955	2985	3015	3045	3075	3105	3135	3165	3195	3225	3255	3285	3315	3345	3375	3405	30 (Riser) + 3405 (U)	N/A	N/A
Leather 1 N/A		Leather 2 N/A		Leather 3 N/A		Leather 4 N/A		Leather 5 N/A		Leather 6 N/A		Leather 8 N/A		COL N/A		S Nail N/A		M Nail N/A	

Fabric SKU: 5191-31

Leather SKU: N/A

Standard Pillows: N/A Finish Req: N

Standard Cushions: Ultra Plush Standard Finish:

COM: 9.25 yards COL: N/A

Kimball Swivel Chair

Width: 31.5 Depth: 39 Height: 37.5

AH: 22.5 SH: 20 SD: 21 IW: 24

Weight: 90 lbs Cube: 36.49

D	E	F	G	H	J	K COM	L	M	N	O	P	Q	R	S	T	U	(# above U) *	S Nail	M Nail
3000	3030	3060	3090	3120	3150	3180	3210	3240	3270	3300	3330	3360	3390	3420	3450	3480	30 (Riser) + 3480 (U)	N/A	N/A
Leather 1 N/A		Leather 2 N/A		Leather 3 N/A		Leather 4 N/A		Leather 5 N/A		Leather 6 N/A		Leather 8 N/A		COL N/A		S Nail N/A		M Nail N/A	

Fabric SKU: 5191-32

Leather SKU: N/A

Standard Pillows: N/A Finish Req: N

Standard Cushions: Ultra Plush Standard Finish:

COM: 9.25 yards COL: N/A

Kimball Swivel Glider

Width: 31.5 Depth: 39 Height: 37.5

AH: 22.5 SH: 20 SD: 21 IW: 24

Weight: 110 lbs Cube: 35.12

D	E	F	G	H	J	K COM	L	M	N	O	P	Q	R	S	T	U	(# above U) *	S Nail	M Nail
3150	3180	3210	3240	3270	3300	3330	3360	3390	3420	3450	3480	3510	3540	3570	3600	3630	30 (Riser) + 3630 (U)	N/A	N/A
Leather 1 N/A		Leather 2 N/A		Leather 3 N/A		Leather 4 N/A		Leather 5 N/A		Leather 6 N/A		Leather 8 N/A		COL N/A		S Nail N/A		M Nail N/A	

Fabric SKU: 5192-01

Leather SKU: N/A

Standard Pillows: (1) Kidney Finish Req: Y

Standard Cushions: Ultra Plush Standard Finish:

COM: 5.5 yards COL: N/A

Lawson Wing Chair

Width: 32.5 Depth: 33.5 Height: 44.5

AH: 22.5 SH: 22 SD: 17.5 IW: 26

Weight: 46 lbs Cube: 34.38

D	E	F	G	H	J	K COM	L	M	N	O	P	Q	R	S	T	U	(# above U) *	S Nail	M Nail
3375	3405	3435	3465	3495	3525	3555	3585	3615	3645	3675	3705	3735	3765	3795	3825	3855	30 (Riser) + 3855 (U)	Std.	N/A
Leather 1 N/A		Leather 2 N/A		Leather 3 N/A		Leather 4 N/A		Leather 5 N/A		Leather 6 N/A		Leather 8 N/A		COL N/A		S Nail N/A		M Nail N/A	

Fabric SKU: 5197-01

Leather SKU: L-5197-01

Standard Pillows: (1) 14.25 x 22.5 Kidney Finish Req: Y

Standard Cushions: Ultra Plush Standard Finish:

COM: 6.75 yards COL: 119 square feet

Seat Depth 21 1/2" without kidney pillow

Martin Wing Chair

Width: 28 Depth: 35 Height: 43.5

AH: 25 SH: 21 SD: 16 IW: 25.5

Weight: 65 lbs Cube: 33.92

D	E	F	G	H	J	K COM	L	M	N	O	P	Q	R	S	T	U	(# above U) *	S Nail	M Nail
2895	2919	2943	2967	2991	3015	3039	3063	3087	3111	3135	3159	3183	3207	3231	3255	3279	24 (Riser) + 3279 (U)	75	N/A
Leather 1 4335		Leather 2 4515		Leather 3 4695		Leather 4 4875		Leather 5 5055		Leather 6 5235		Leather 8 6870		COL 3087		S Nail 75		M Nail N/A	

Upholstery

**Pillows are not available on leather SKUs*

Fabric SKU: 5198-01

Leather SKU: L-5198-01

Standard Pillows: N/A Finish Req: Y

Standard Cushions: High Resiliency 40 Standard Finish:

COM: 2.25 yards COL: 38.7 square feet

Warwick Occasional Chair

Width: 23.5 Depth: 26.5 Height: 35

AH: 25.5 SH: 17.5 SD: 19 IW: 18

Weight: 35 lbs Cube: 15.74

D	E	F	G	H	J	K COM	L	M	N	O	P	Q	R	S	T	U	(# above U) *	S Nail	M Nail
1314	1323	1332	1341	1350	1359	1368	1377	1386	1395	1404	1413	1422	1431	1440	1449	1458	9 (Riser) + 1458 (U)	45	60
Leather 1 1875		Leather 2 1935		Leather 3 1995		Leather 4 2055		Leather 5 2115		Leather 6 2175		Leather 8 2715		COL 1386		S Nail 45		M Nail 60	

Fabric SKU: 5198-A2

Leather SKU: L-5198-A2

Standard Pillows: N/A Finish Req: Y

Standard Cushions: High Resiliency 40 Standard Finish:

COM: 2.25 yards COL: 38.7 square feet

Warwick Occasional Chair

Width: 23.5 Depth: 26.5 Height: 35

AH: 25.5 SH: 17.5 SD: 19 IW: 18

Weight: 35 lbs Cube: 15.74

D	E	F	G	H	J	K COM	L	M	N	O	P	Q	R	S	T	U	(# above U) *	S Nail	M Nail
1350	1359	1368	1377	1386	1395	1404	1413	1422	1431	1440	1449	1458	1467	1476	1485	1494	9 (Riser) + 1494 (U)	45	60
Leather 1 1935		Leather 2 1995		Leather 3 2055		Leather 4 2115		Leather 5 2175		Leather 6 2235		Leather 8 2775		COL 1422		S Nail 45		M Nail 60	

Fabric SKU: 5198-A4

Leather SKU: L-5198-A4

Standard Pillows: N/A Finish Req: Y

Standard Cushions: High Resiliency 40 Standard Finish:

COM: 2.25 yards COL: 38.7 square feet

Warwick Occasional Chair

Width: 23.5 Depth: 26.5 Height: 36

AH: 25.5 SH: 17.5 SD: 19 IW: 18

Weight: 35 lbs Cube: 15.74

D	E	F	G	H	J	K COM	L	M	N	O	P	Q	R	S	T	U	(# above U) *	S Nail	M Nail
1386	1395	1404	1413	1422	1431	1440	1449	1458	1467	1476	1485	1494	1503	1512	1521	1530	9 (Riser) + 1530 (U)	45	60
Leather 1 1965		Leather 2 2025		Leather 3 2085		Leather 4 2145		Leather 5 2205		Leather 6 2265		Leather 8 2805		COL 1458		S Nail 45		M Nail 60	

Fabric SKU: 5216-01

Leather SKU: N/A

Standard Pillows: N/A Finish Req: Y

Standard Cushions: Ultra Plush Standard Finish:

COM: 7 yards COL: N/A

Riverton Occasional Chair

Width: 32 Depth: 34.5 Height: 43

AH: 23 SH: 22 SD: 24 IW: 24.5

Weight: 55 lbs Cube: 34.38

D	E	F	G	H	J	K COM	L	M	N	O	P	Q	R	S	T	U	(# above U) *	S Nail	M Nail
2925	2949	2973	2997	3021	3045	3069	3093	3117	3141	3165	3189	3213	3237	3261	3285	3309	24 (Riser) + 3309 (U)	120	N/A
Leather 1 N/A		Leather 2 N/A		Leather 3 N/A		Leather 4 N/A		Leather 5 N/A		Leather 6 N/A		Leather 8 N/A		COL N/A		S Nail N/A		M Nail N/A	

Fabric SKU: 5227-01

Leather SKU: N/A

Standard Pillows: N/A Finish Req: Y

Standard Cushions: Ultra Plush Standard Finish:

COM: 4.75 yards COL: N/A

Ellison Occasional Chair

Width: 27 Depth: 35 Height: 36

AH: 25 SH: 20.5 SD: 20.5 IW: 21

Weight: 40 lbs Cube: 23.89

D	E	F	G	H	J	K COM	L	M	N	O	P	Q	R	S	T	U	(# above U) *	S Nail	M Nail
2550	2565	2580	2595	2610	2625	2640	2655	2670	2685	2700	2715	2730	2745	2760	2775	2790	15 (Riser) + 2790 (U)	150	N/A
Leather 1 N/A		Leather 2 N/A		Leather 3 N/A		Leather 4 N/A		Leather 5 N/A		Leather 6 N/A		Leather 8 N/A		COL N/A		S Nail N/A		M Nail N/A	

Fabric SKU: 5227-20

Leather SKU: N/A

Standard Pillows: N/A Finish Req: Y

Standard Cushions: High Resiliency 30 Standard Finish:

COM: 2.25 yards COL: N/A

Ellison Ottoman

Width: 26 Depth: 21 Height: 18

AH: 0 SH: 0 SD: 0 IW: 0

Weight: 15 lbs Cube: 10.77

D	E	F	G	H	J	K COM	L	M	N	O	P	Q	R	S	T	U	(# above U) *	S Nail	M Nail
1275	1284	1293	1302	1311	1320	1329	1338	1347	1356	1365	1374	1383	1392	1401	1410	1419	9 (Riser) + 1419 (U)	30	N/A
Leather 1 N/A		Leather 2 N/A		Leather 3 N/A		Leather 4 N/A		Leather 5 N/A		Leather 6 N/A		Leather 8 N/A		COL N/A		S Nail N/A		M Nail N/A	

Upholstery

**Pillows are not available on leather SKUs*

Fabric SKU: 5274-01

Leather SKU: N/A

Standard Pillows: N/A Finish Req: Y

Standard Cushions: Ultra Plush Standard Finish:

COM: 5.25 yards COL: N/A

Griffin Occasional Chair

Width: 29.5 Depth: 33.5 Height: 38.5

AH: 23.5 SH: 20.5 SD: 22 IW: 23

Weight: 45 lbs Cube: 29.69

D	E	F	G	H	J	K COM	L	M	N	O	P	Q	R	S	T	U	(# above U) *	S Nail	M Nail
2250	2265	2280	2295	2310	2325	2340	2355	2370	2385	2400	2415	2430	2445	2460	2475	2490	15 (Riser) + 2490 (U)	N/A	N/A
Leather 1 N/A		Leather 2 N/A		Leather 3 N/A		Leather 4 N/A		Leather 5 N/A		Leather 6 N/A		Leather 8 N/A		COL N/A		S Nail N/A		M Nail N/A	

Fabric SKU: 5300-01

Leather SKU: L-5300-01

Standard Pillows: N/A Finish Req: Y

Standard Cushions: Ultra Plush Standard Finish:

COM: 7 yards COL: 102 square feet

Felix Lounge Chair

Width: 34 Depth: 33 Height: 41

AH: 24.5 SH: 21 SD: 22.5 IW: 25

Weight: 70 lbs Cube: 34.38

D	E	F	G	H	J	K COM	L	M	N	O	P	Q	R	S	T	U	(# above U) *	S Nail	M Nail
2490	2511	2532	2553	2574	2595	2616	2637	2658	2679	2700	2721	2742	2763	2784	2805	2826	21 (Riser) + 2826 (U)	75	90
Leather 1 3825		Leather 2 3990		Leather 3 4155		Leather 4 4320		Leather 5 4485		Leather 6 4650		Leather 8 6060		COL 2658		S Nail 75		M Nail 90	

Fabric SKU: 5345-01

Leather SKU: N/A

Standard Pillows: N/A Finish Req: Y

Standard Cushions: High Resiliency 40 Standard Finish:

COM: 2.75 yards COL: N/A

Sophia Occasional Chair

Width: 24 Depth: 27.5 Height: 37

AH: 26 SH: 20 SD: 20 IW: 19

Weight: 25 lbs Cube: 21.65

D	E	F	G	H	J	K COM	L	M	N	O	P	Q	R	S	T	U	(# above U) *	S Nail	M Nail
1575	1584	1593	1602	1611	1620	1629	1638	1647	1656	1665	1674	1683	1692	1701	1710	1719	9 (Riser) + 1719 (U)	N/A	N/A
Leather 1 N/A		Leather 2 N/A		Leather 3 N/A		Leather 4 N/A		Leather 5 N/A		Leather 6 N/A		Leather 8 N/A		COL N/A		S Nail N/A		M Nail N/A	

Fabric SKU: 5366-01

Leather SKU: L-5366-01

Standard Pillows: N/A Finish Req: Y

Standard Cushions: Ultra Plush Standard Finish:

COM: 9 yards COL: 144.5 square feet

Grant Lounge Chair

Width: 34 Depth: 35 Height: 40.5

AH: 24.5 SH: 21 SD: 20 IW: 24

Weight: 65 lbs Cube: 33.92

D	E	F	G	H	J	K COM	L	M	N	O	P	Q	R	S	T	U	(# above U) *	S Nail	M Nail
2520	2544	2568	2592	2616	2640	2664	2688	2712	2736	2760	2784	2808	2832	2856	2880	2904	24 (Riser) + 2904 (U)	135	150
Leather 1 4245		Leather 2 4470		Leather 3 4695		Leather 4 4920		Leather 5 5145		Leather 6 5370		Leather 8 7365		COL 2712		S Nail 135		M Nail 150	

Fabric SKU: 5366-20

Leather SKU: L-5366-20

Standard Pillows: N/A Finish Req: Y

Standard Cushions: High Resiliency 30 Standard Finish:

COM: 3.5 yards COL: 57.6 square feet

Grant Ottoman

Width: 28 Depth: 21.5 Height: 18

AH: 0 SH: 0 SD: 0 IW: 0

Weight: 25 lbs Cube: 10.77

D	E	F	G	H	J	K COM	L	M	N	O	P	Q	R	S	T	U	(# above U) *	S Nail	M Nail
1155	1167	1179	1191	1203	1215	1227	1239	1251	1263	1275	1287	1299	1311	1323	1335	1347	12 (Riser) + 1347 (U)	45	60
Leather 1 2010		Leather 2 2100		Leather 3 2190		Leather 4 2280		Leather 5 2370		Leather 6 2460		Leather 8 3255		COL 1251		S Nail 45		M Nail 60	

Fabric SKU: 5400-01

Leather SKU: N/A

Standard Pillows: N/A Finish Req: Y

Standard Cushions: High Resiliency 40 Standard Finish:

COM: 2.75 yards COL: N/A

Granger Occasional Chair

Width: 28 Depth: 28 Height: 40.5

AH: 28.5 SH: 20.5 SD: 20 IW: 23.5

Weight: 35 lbs Cube: 23.22

D	E	F	G	H	J	K COM	L	M	N	O	P	Q	R	S	T	U	(# above U) *	S Nail	M Nail
1470	1479	1488	1497	1506	1515	1524	1533	1542	1551	1560	1569	1578	1587	1596	1605	1614	9 (Riser) + 1614 (U)	45	N/A
Leather 1 N/A		Leather 2 N/A		Leather 3 N/A		Leather 4 N/A		Leather 5 N/A		Leather 6 N/A		Leather 8 N/A		COL N/A		S Nail N/A		M Nail N/A	

Upholstery

**Pillows are not available on leather SKUs*

Fabric SKU: **5403-04**

Leather SKU: **N/A**

Standard Pillows: N/A **Finish Req:** Y

Standard Cushions: High Resiliency 40 **Standard Finish:**

COM: 3.25 yards **COL:** N/A

Available with Stretchers: 8403-04 "Frame not warranted for Contract/Commercial application."

Harvey Arm Chair

Width: 25 **Depth:** 26 **Height:** 39.5
AH: 23.5 **SH:** 20.5 **SD:** 18.5 **IW:** 27
Weight: 30 lbs **Cube:** 21.65

D	E	F	G	H	J	K COM	L	M	N	O	P	Q	R	S	T	U	(# above U) *	S Nail	M Nail
1530	1539	1548	1557	1566	1575	1584	1593	1602	1611	1620	1629	1638	1647	1656	1665	1674	9 (Riser) + 1674 (U)	N/A	N/A
Leather 1		Leather 2		Leather 3		Leather 4		Leather 5		Leather 6		Leather 8		COL		S Nail		M Nail	
N/A		N/A		N/A		N/A		N/A		N/A		N/A		N/A		N/A		N/A	

Fabric SKU: **5407-01**

Leather SKU: **N/A**

Standard Pillows: (1) 16 x 16 **Finish Req:** Y

Standard Cushions: Blendown **Standard Finish:**

COM: 7 yards **COL:** N/A

Adair Occasional Chair

Width: 33.5 **Depth:** 34 **Height:** 39.5
AH: 25.5 **SH:** 21.5 **SD:** 18 **IW:** 24.5
Weight: 55 lbs **Cube:** 29.69

D	E	F	G	H	J	K COM	L	M	N	O	P	Q	R	S	T	U	(# above U) *	S Nail	M Nail
2460	2484	2508	2532	2556	2580	2604	2628	2652	2676	2700	2724	2748	2772	2796	2820	2844	24 (Riser) + 2844 (U)	N/A	N/A
Leather 1		Leather 2		Leather 3		Leather 4		Leather 5		Leather 6		Leather 8		COL		S Nail		M Nail	
N/A		N/A		N/A		N/A		N/A		N/A		N/A		N/A		N/A		N/A	

Fabric SKU: **5407-20**

Leather SKU: **N/A**

Standard Pillows: N/A **Finish Req:** Y

Standard Cushions: High Resiliency 20 **Standard Finish:**

COM: 2.75 yards **COL:** N/A

Adair Ottoman

Width: 31.5 **Depth:** 23 **Height:** 16
AH: 0 **SH:** 0 **SD:** 0 **IW:** 0
Weight: 17 lbs **Cube:** 13.69

D	E	F	G	H	J	K COM	L	M	N	O	P	Q	R	S	T	U	(# above U) *	S Nail	M Nail
1530	1539	1548	1557	1566	1575	1584	1593	1602	1611	1620	1629	1638	1647	1656	1665	1674	9 (Riser) + 1674 (U)	N/A	N/A
Leather 1		Leather 2		Leather 3		Leather 4		Leather 5		Leather 6		Leather 8		COL		S Nail		M Nail	
N/A		N/A		N/A		N/A		N/A		N/A		N/A		N/A		N/A		N/A	

Fabric SKU: **5410-A4**

Leather SKU: **L-5410-A4**

Standard Pillows: N/A **Finish Req:** Y

Standard Cushions: High Resiliency 40 **Standard Finish:**

COM: 2.25 yards **COL:** 45 square feet

Allen Occasional Chair

Width: 25 **Depth:** 27 **Height:** 37.5
AH: 26.5 **SH:** 20.5 **SD:** 20 **IW:** 18
Weight: 35 lbs **Cube:** 21.65

D	E	F	G	H	J	K COM	L	M	N	O	P	Q	R	S	T	U	(# above U) *	S Nail	M Nail
1410	1419	1428	1437	1446	1455	1464	1473	1482	1491	1500	1509	1518	1527	1536	1545	1554	9 (Riser) + 1554 (U)	Std.	N/A
Leather 1		Leather 2		Leather 3		Leather 4		Leather 5		Leather 6		Leather 8		COL		S Nail		M Nail	
1995		2070		2145		2220		2295		2370		3000		1482		Std.		N/A	

Fabric SKU: **5418-04**

Leather SKU: **L-5418-04**

Standard Pillows: N/A **Finish Req:** Y

Standard Cushions: High Resiliency 40 **Standard Finish:**

COM: 3.75 yards **COL:** 62 square feet

Sabine Arm Chair

Width: 26.5 **Depth:** 26.5 **Height:** 39
AH: 24.25 **SH:** 20 **SD:** 20.25 **IW:** 22.5
Weight: 25 lbs **Cube:** 21.65

D	E	F	G	H	J	K COM	L	M	N	O	P	Q	R	S	T	U	(# above U) *	S Nail	M Nail
2130	2142	2154	2166	2178	2190	2202	2214	2226	2238	2250	2262	2274	2286	2298	2310	2322	12 (Riser) + 2322 (U)	N/A	N/A
Leather 1		Leather 2		Leather 3		Leather 4		Leather 5		Leather 6		Leather 8		COL		S Nail		M Nail	
2835		2940		3045		3150		3255		3360		4215		2226		N/A		N/A	

Fabric SKU: **5421-01**

Leather SKU: **L-5421-01**

Standard Pillows: N/A **Finish Req:** N

Standard Cushions: Classic Plush **Standard Finish:**

COM: 5.5 yards **COL:** 107 square feet

Aster Lounge Chair

Width: 30 **Depth:** 33.25 **Height:** 33.25
AH: 24.75 **SH:** 18.75 **SD:** 19.5 **IW:** 22
Weight: 60 lbs **Cube:** 19.19

D	E	F	G	H	J	K COM	L	M	N	O	P	Q	R	S	T	U	(# above U) *	S Nail	M Nail
2025	2043	2061	2079	2097	2115	2133	2151	2169	2187	2205	2223	2241	2259	2277	2295	2313	18 (Riser) + 2313 (U)	45	60
Leather 1		Leather 2		Leather 3		Leather 4		Leather 5		Leather 6		Leather 8		COL		S Nail		M Nail	
3375		3540		3705		3870		4035		4200		5670		2169		45		60	

Upholstery

**Pillows are not available on leather SKUs*

Fabric SKU: **5421-11**

Leather SKU: **L-5421-31**

Standard Pillows: N/A Finish Req: N

Standard Cushions: Classic Plush Standard Finish: Contemporary

COM: 5.5 yards COL: 107 square feet

Aster Swivel Chair

Width: 30 Depth: 33.25 Height: 33.25

AH: 24.75 SH: 18.75 SD: 19.5 IW: 22

Weight: 60 lbs Cube: 29.69

D	E	F	G	H	J	K COM	L	M	N	O	P	Q	R	S	T	U	(# above U) *	S Nail	M Nail
2100	2118	2136	2154	2172	2190	2208	2226	2244	2262	2280	2298	2316	2334	2352	2370	2388	18 (Riser) + 2388 (U)	45	60
Leather 1 3450		Leather 2 3615		Leather 3 3780		Leather 4 3945		Leather 5 4110		Leather 6 4275		Leather 8 5745		COL 2244		S Nail 45		M Nail 60	

Fabric SKU: **5422-01**

Leather SKU: **N/A**

Standard Pillows: N/A Finish Req: Y

Standard Cushions: Blendown Standard Finish:

COM: 2.75 yards COL: N/A

Lancaster Occasional Chair

Width: 27.5 Depth: 27.5 Height: 40

AH: 27.5 SH: 22.5 SD: 20.5 IW: 24

Weight: 45 lbs Cube: 21.65

D	E	F	G	H	J	K COM	L	M	N	O	P	Q	R	S	T	U	(# above U) *	S Nail	M Nail
1680	1689	1698	1707	1716	1725	1734	1743	1752	1761	1770	1779	1788	1797	1806	1815	1824	9 (Riser) + 1824 (U)	N/A	N/A
Leather 1 N/A		Leather 2 N/A		Leather 3 N/A		Leather 4 N/A		Leather 5 N/A		Leather 6 N/A		Leather 8 N/A		COL N/A		S Nail N/A		M Nail N/A	

Fabric SKU: **5432-04**

Leather SKU: **L-5432-04**

Standard Pillows: N/A Finish Req: Y

Standard Cushions: High Resiliency 55 Standard Finish:

COM: 2 yards COL: 34.2 square feet

Chatham Arm Chair

Width: 23 Depth: 24 Height: 37.5

AH: 24.5 SH: 19.5 SD: 19 IW: 18.5

Weight: 30 lbs Cube: 15.74

D	E	F	G	H	J	K COM	L	M	N	O	P	Q	R	S	T	U	(# above U) *	S Nail	M Nail
1155	1161	1167	1173	1179	1185	1191	1197	1203	1209	1215	1221	1227	1233	1239	1245	1251	6 (Riser) + 1251 (U)	45	N/A
Leather 1 1635		Leather 2 1695		Leather 3 1755		Leather 4 1815		Leather 5 1875		Leather 6 1935		Leather 8 2415		COL 1203		S Nail 45		M Nail N/A	

Fabric SKU: **5432-A4**

Leather SKU: **L-5432-A4**

Standard Pillows: N/A Finish Req: Y

Standard Cushions: High Resiliency 55 Standard Finish:

COM: 2 yards COL: 34.2 square feet

Chatham Arm Chair

Width: 23 Depth: 24 Height: 37.5

AH: 24.5 SH: 19.5 SD: 19 IW: 18.5

Weight: 30 lbs Cube: 15.74

D	E	F	G	H	J	K COM	L	M	N	O	P	Q	R	S	T	U	(# above U) *	S Nail	M Nail
1272	1278	1284	1290	1296	1302	1308	1314	1320	1326	1332	1338	1344	1350	1356	1362	1368	6 (Riser) + 1368 (U)	45	N/A
Leather 1 1710		Leather 2 1770		Leather 3 1830		Leather 4 1890		Leather 5 1950		Leather 6 2010		Leather 8 2490		COL 1320		S Nail 45		M Nail N/A	

Fabric SKU: **5434-04**

Leather SKU: **L-5434-04**

Standard Pillows: N/A Finish Req: Y

Standard Cushions: High Resiliency 55 Standard Finish:

COM: 2 yards COL: 34.2 square feet

Delano Arm Chair

Width: 23 Depth: 24 Height: 37.5

AH: 25.5 SH: 19 SD: 20 IW: 20.5

Weight: 30 lbs Cube: 15.74

D	E	F	G	H	J	K COM	L	M	N	O	P	Q	R	S	T	U	(# above U) *	S Nail	M Nail
1200	1206	1212	1218	1224	1230	1236	1242	1248	1254	1260	1266	1272	1278	1284	1290	1296	6 (Riser) + 1296 (U)	45	N/A
Leather 1 1695		Leather 2 1755		Leather 3 1815		Leather 4 1875		Leather 5 1935		Leather 6 1995		Leather 8 2475		COL 1248		S Nail 45		M Nail N/A	

Fabric SKU: **5434-A4**

Leather SKU: **L-5434-A4**

Standard Pillows: N/A Finish Req: Y

Standard Cushions: High Resiliency 55 Standard Finish:

COM: 2 yards COL: 34.2 square feet

Delano Arm Chair

Width: 24 Depth: 27 Height: 38

AH: 25.5 SH: 19 SD: 20 IW: 20.5

Weight: 35 lbs Cube: 21.09

D	E	F	G	H	J	K COM	L	M	N	O	P	Q	R	S	T	U	(# above U) *	S Nail	M Nail
1272	1278	1284	1290	1296	1302	1308	1314	1320	1326	1332	1338	1344	1350	1356	1362	1368	6 (Riser) + 1368 (U)	45	N/A
Leather 1 1785		Leather 2 1845		Leather 3 1905		Leather 4 1965		Leather 5 2025		Leather 6 2085		Leather 8 2565		COL 1320		S Nail 45		M Nail N/A	

Upholstery

**Pillows are not available on leather SKUs*

Fabric SKU: **5440-01**

Leather SKU: **N/A**

Standard Pillows: N/A Finish Req: Y

Standard Cushions: Blendown Standard Finish:

COM: 4.5 yards COL: N/A

Tessa Occasional Chair

Width: 29 Depth: 33.5 Height: 37.25

AH: 25 SH: 20.75 SD: 21 IW: 26.25

Weight: 47 lbs Cube: 23.89

D	E	F	G	H	J	K COM	L	M	N	O	P	Q	R	S	T	U	(# above U) *	S Nail	M Nail
2310	2325	2340	2355	2370	2385	2400	2415	2430	2445	2460	2475	2490	2505	2520	2535	2550	15 (Riser) + 2550 (U)	N/A	N/A
Leather 1 N/A		Leather 2 N/A		Leather 3 N/A		Leather 4 N/A		Leather 5 N/A		Leather 6 N/A		Leather 8 N/A		COL N/A		S Nail N/A		M Nail N/A	

Fabric SKU: **5449-04**

Leather SKU: **N/A**

Standard Pillows: N/A Finish Req: Y

Standard Cushions: High Resiliency 40 Standard Finish:

COM: 2 yards COL: N/A

Frame not warranted for Contract/Commercial application.

Helena Arm Chair

Width: 24 Depth: 23.5 Height: 39.5

AH: 27.5 SH: 20.5 SD: 18 IW: 19.5

Weight: 25 lbs Cube: 15.74

D	E	F	G	H	J	K COM	L	M	N	O	P	Q	R	S	T	U	(# above U) *	S Nail	M Nail
1350	1356	1362	1368	1374	1380	1386	1392	1398	1404	1410	1416	1422	1428	1434	1440	1446	6 (Riser) + 1446 (U)	45	N/A
Leather 1 N/A		Leather 2 N/A		Leather 3 N/A		Leather 4 N/A		Leather 5 N/A		Leather 6 N/A		Leather 8 N/A		COL N/A		S Nail N/A		M Nail N/A	

Fabric SKU: **5449-05**

Leather SKU: **N/A**

Standard Pillows: N/A Finish Req: Y

Standard Cushions: High Resiliency 40 Standard Finish:

COM: 2 yards COL: N/A

Frame not warranted for Contract/Commercial application.

Helena Side Chair

Width: 20.5 Depth: 24 Height: 39.5

AH: 0 SH: 20.5 SD: 17.5 IW: 0

Weight: 25 lbs Cube: 15.74

D	E	F	G	H	J	K COM	L	M	N	O	P	Q	R	S	T	U	(# above U) *	S Nail	M Nail
1305	1311	1317	1323	1329	1335	1341	1347	1353	1359	1365	1371	1377	1383	1389	1395	1401	6 (Riser) + 1401 (U)	45	N/A
Leather 1 N/A		Leather 2 N/A		Leather 3 N/A		Leather 4 N/A		Leather 5 N/A		Leather 6 N/A		Leather 8 N/A		COL N/A		S Nail N/A		M Nail N/A	

Fabric SKU: **5451-01**

Leather SKU: **N/A**

Standard Pillows: N/A Finish Req: Y

Standard Cushions: Blendown Standard Finish:

COM: 6.75 yards COL: N/A

Brannon Occasional Chair

Width: 30 Depth: 34 Height: 30.75

AH: 26.75 SH: 20.5 SD: 21.5 IW: 26.5

Weight: 60 lbs Cube: 29.69

D	E	F	G	H	J	K COM	L	M	N	O	P	Q	R	S	T	U	(# above U) *	S Nail	M Nail
2550	2568	2586	2604	2622	2640	2658	2676	2694	2712	2730	2748	2766	2784	2802	2820	2838	18 (Riser) + 2838 (U)	N/A	N/A
Leather 1 N/A		Leather 2 N/A		Leather 3 N/A		Leather 4 N/A		Leather 5 N/A		Leather 6 N/A		Leather 8 N/A		COL N/A		S Nail N/A		M Nail N/A	

Fabric SKU: **5452-04**

Leather SKU: **N/A**

Standard Pillows: N/A Finish Req: Y

Standard Cushions: High Resiliency 55 Standard Finish:

COM: 2 yards COL: N/A

Lori Arm Chair

Width: 23 Depth: 24 Height: 37.5

AH: 24.5 SH: 19.5 SD: 19 IW: 18.5

Weight: 30 lbs Cube: 15.74

D	E	F	G	H	J	K COM	L	M	N	O	P	Q	R	S	T	U	(# above U) *	S Nail	M Nail
1050	1056	1062	1068	1074	1080	1086	1092	1098	1104	1110	1116	1122	1128	1134	1140	1146	6 (Riser) + 1146 (U)	45	N/A
Leather 1 N/A		Leather 2 N/A		Leather 3 N/A		Leather 4 N/A		Leather 5 N/A		Leather 6 N/A		Leather 8 N/A		COL N/A		S Nail N/A		M Nail N/A	

Fabric SKU: **5452-A4**

Leather SKU: **N/A**

Standard Pillows: N/A Finish Req: Y

Standard Cushions: High Resiliency 55 Standard Finish:

COM: 2 yards COL: N/A

Lori Arm Chair

Width: 23 Depth: 24 Height: 37.5

AH: 24.5 SH: 19.5 SD: 19 IW: 18.5

Weight: 30 lbs Cube: 15.74

D	E	F	G	H	J	K COM	L	M	N	O	P	Q	R	S	T	U	(# above U) *	S Nail	M Nail
1122	1128	1134	1140	1146	1152	1158	1164	1170	1176	1182	1188	1194	1200	1206	1212	1218	6 (Riser) + 1218 (U)	45	N/A
Leather 1 N/A		Leather 2 N/A		Leather 3 N/A		Leather 4 N/A		Leather 5 N/A		Leather 6 N/A		Leather 8 N/A		COL N/A		S Nail N/A		M Nail N/A	

Upholstery

**Pillows are not available on leather SKUs*

Fabric SKU: **5462-01**

Leather SKU: **N/A**

Standard Pillows: N/A Finish Req: Y

Standard Cushions: High Resiliency 30 Standard Finish:

COM: 6.5 yards COL: N/A

Hawley Lounge Chair

Width: 30 Depth: 38.5 Height: 39.5

AH: 23.5 SH: 17 SD: 22.5 IW: 21.5

Weight: 65 lbs Cube: 33.92

D	E	F	G	H	J	K COM	L	M	N	O	P	Q	R	S	T	U	(# above U) *	S Nail	M Nail
1950	1968	1986	2004	2022	2040	2058	2076	2094	2112	2130	2148	2166	2184	2202	2220	2238	18 (Riser) + 2238 (U)	60	75
Leather 1 N/A		Leather 2 N/A		Leather 3 N/A		Leather 4 N/A		Leather 5 N/A		Leather 6 N/A		Leather 8 N/A		COL N/A		S Nail N/A		M Nail N/A	

Fabric SKU: **5462-20**

Leather SKU: **N/A**

Standard Pillows: N/A Finish Req: Y

Standard Cushions: High Resiliency 30 Standard Finish:

COM: 2 yards COL: N/A

Hawley Ottoman

Width: 26.5 Depth: 20 Height: 18

AH: 0 SH: 0 SD: 0 IW: 0

Weight: 25 lbs Cube: 10.77

D	E	F	G	H	J	K COM	L	M	N	O	P	Q	R	S	T	U	(# above U) *	S Nail	M Nail
900	906	912	918	924	930	936	942	948	954	960	966	972	978	984	990	996	6 (Riser) + 996 (U)	30	45
Leather 1 N/A		Leather 2 N/A		Leather 3 N/A		Leather 4 N/A		Leather 5 N/A		Leather 6 N/A		Leather 8 N/A		COL N/A		S Nail N/A		M Nail N/A	

Fabric SKU: **5464-01**

Leather SKU: **N/A**

Standard Pillows: N/A Finish Req: Y

Standard Cushions: High Resiliency 35 Standard Finish:

COM: 2.25 yards COL: N/A

Jalen Occasional Chair

Width: 27 Depth: 26.25 Height: 29.75

AH: 27.5 SH: 19 SD: 23 IW: 20

Weight: 27 lbs Cube: 21.65

D	E	F	G	H	J	K COM	L	M	N	O	P	Q	R	S	T	U	(# above U) *	S Nail	M Nail
1545	1551	1557	1563	1569	1575	1581	1587	1593	1599	1605	1611	1617	1623	1629	1635	1641	6 (Riser) + 1641 (U)	N/A	N/A
Leather 1 N/A		Leather 2 N/A		Leather 3 N/A		Leather 4 N/A		Leather 5 N/A		Leather 6 N/A		Leather 8 N/A		COL N/A		S Nail N/A		M Nail N/A	

Fabric SKU: **5474-05**

Leather SKU: **L-5474-05**

Standard Pillows: N/A Finish Req: Y

Standard Cushions: High Resiliency 40 Standard Finish:

COM: 3.25 yards COL: 51 square feet

Bartow Side Chair

Width: 24 Depth: 30 Height: 46.5

AH: 0 SH: 20 SD: 19 IW: 24

Weight: 30 lbs Cube: 21.65

D	E	F	G	H	J	K COM	L	M	N	O	P	Q	R	S	T	U	(# above U) *	S Nail	M Nail
1545	1557	1569	1581	1593	1605	1617	1629	1641	1653	1665	1677	1689	1701	1713	1725	1737	12 (Riser) + 1737 (U)	Std.	15
Leather 1 2265		Leather 2 2340		Leather 3 2415		Leather 4 2490		Leather 5 2565		Leather 6 2640		Leather 8 3345		COL 1641		S Nail Std.		M Nail 15	

Fabric SKU: **5481-01**

Leather SKU: **N/A**

Standard Pillows: N/A Finish Req: Y

Standard Cushions: High Resiliency 40 Standard Finish:

COM: 3.25 yards COL: N/A

Marley Occasional Chair

Width: 26.5 Depth: 31 Height: 34.5

AH: 0 SH: 18.5 SD: 21 IW: 0

Weight: 28 lbs Cube: 21.65

D	E	F	G	H	J	K COM	L	M	N	O	P	Q	R	S	T	U	(# above U) *	S Nail	M Nail
1875	1887	1899	1911	1923	1935	1947	1959	1971	1983	1995	2007	2019	2031	2043	2055	2067	12 (Riser) + 2067 (U)	Std.	N/A
Leather 1 N/A		Leather 2 N/A		Leather 3 N/A		Leather 4 N/A		Leather 5 N/A		Leather 6 N/A		Leather 8 N/A		COL N/A		S Nail N/A		M Nail N/A	

Fabric SKU: **5484-05**

Leather SKU: **N/A**

Standard Pillows: N/A Finish Req: Y

Standard Cushions: High Resiliency 40 Standard Finish:

COM: 2.5 yards COL: N/A

Leon Side Chair

Width: 24 Depth: 30 Height: 46.5

AH: 0 SH: 21 SD: 20 IW: 24

Weight: 30 lbs Cube: 24.14

D	E	F	G	H	J	K COM	L	M	N	O	P	Q	R	S	T	U	(# above U) *	S Nail	M Nail
1380	1389	1398	1407	1416	1425	1434	1443	1452	1461	1470	1479	1488	1497	1506	1515	1524	9 (Riser) + 1524 (U)	45	60
Leather 1 N/A		Leather 2 N/A		Leather 3 N/A		Leather 4 N/A		Leather 5 N/A		Leather 6 N/A		Leather 8 N/A		COL N/A		S Nail N/A		M Nail N/A	

Upholstery

**Pillows are not available on leather SKUs*

Fabric SKU: 5493-01

Leather SKU: L-5493-01

Silvio Occasional Chair

Width: 27 Depth: 31.75 Height: 35.5
 AH: 24 SH: 20.5 SD: 18.75 IW: 22.25
 Weight: 40 lbs Cube: 17.61

Standard Pillows: N/A Finish Req: Y
 Standard Cushions: High Resiliency 35 Standard Finish:
 COM: 2.75 yards COL: 45 square feet

Features natural cane accents that are handwoven using the peel of natural rattan. As with any natural product, nature's imperfections and hallmarks will be present in the cane materials. Cane is a handcrafted product dating back to the Ancient Egyptians.

D	E	F	G	H	J	K COM	L	M	N	O	P	Q	R	S	T	U	(# above U) *	S Nail	M Nail
1875	1884	1893	1902	1911	1920	1929	1938	1947	1956	1965	1974	1983	1992	2001	2010	2019	9 (Riser) + 2019 (U)	N/A	N/A
Leather 1 2475		Leather 2 2550		Leather 3 2625		Leather 4 2700		Leather 5 2775		Leather 6 2850		Leather 8 3480		COL 1947		S Nail N/A		M Nail N/A	

Fabric SKU: 5499-01

Leather SKU: N/A

Chadwick Occasional Chair

Width: 30 Depth: 37 Height: 37.5
 AH: 23 SH: 19 SD: 17.5 IW: 26.5
 Weight: 61 lbs Cube: 36.49

Standard Pillows: (1) Kidney Pillow Finish Req: Y
 Standard Cushions: Blendown Standard Finish:
 COM: 5.25 yards COL: N/A

Features natural cane accents that are handwoven using the peel of natural rattan. As with any natural product, nature's imperfections and hallmarks will be present in the cane materials. Cane is a handcrafted product dating back to the Ancient Egyptians.

D	E	F	G	H	J	K COM	L	M	N	O	P	Q	R	S	T	U	(# above U) *	S Nail	M Nail
2760	2775	2790	2805	2820	2835	2850	2865	2880	2895	2910	2925	2940	2955	2970	2985	3000	15 (Riser) + 3000 (U)	N/A	N/A
Leather 1 N/A		Leather 2 N/A		Leather 3 N/A		Leather 4 N/A		Leather 5 N/A		Leather 6 N/A		Leather 8 N/A		COL N/A		S Nail N/A		M Nail N/A	

Fabric SKU: 5706-40

Leather SKU: L-5706-40

Leland Settee

Width: 54.5 Depth: 36 Height: 35
 AH: 25 SH: 21.5 SD: 24 IW: 45
 Weight: 75 lbs Cube: 50.95

Standard Pillows: (2) 16 x 16 Finish Req: Y
 Standard Cushions: Ultra Plush Standard Finish:
 COM: 9.75 yards COL: 158.1 square feet

D	E	F	G	H	J	K COM	L	M	N	O	P	Q	R	S	T	U	(# above U) *	S Nail	M Nail
3000	3030	3060	3090	3120	3150	3180	3210	3240	3270	3300	3330	3360	3390	3420	3450	3480	30 (Riser) + 3480 (U)	60	75
Leather 1 4785		Leather 2 5025		Leather 3 5265		Leather 4 5505		Leather 5 5745		Leather 6 5985		Leather 8 8160		COL 3240		S Nail 60		M Nail 75	

Fabric SKU: 5744-40

Leather SKU: N/A

Dewey Settee

Width: 47 Depth: 27 Height: 38.5
 AH: 0 SH: 20.5 SD: 20.5 IW: 0
 Weight: 50 lbs Cube: 42.5

Standard Pillows: N/A Finish Req: Y
 Standard Cushions: High Resiliency 30 Standard Finish:
 COM: 5 yards COL: N/A

D	E	F	G	H	J	K COM	L	M	N	O	P	Q	R	S	T	U	(# above U) *	S Nail	M Nail
1815	1830	1845	1860	1875	1890	1905	1920	1935	1950	1965	1980	1995	2010	2025	2040	2055	15 (Riser) + 2055 (U)	N/A	0
Leather 1 N/A		Leather 2 N/A		Leather 3 N/A		Leather 4 N/A		Leather 5 N/A		Leather 6 N/A		Leather 8 N/A		COL N/A		S Nail N/A		M Nail N/A	

Fabric SKU: 5747-40

Leather SKU: N/A

Brinkley Settee

Width: 58.5 Depth: 31 Height: 44.5
 AH: 20 SH: 19.5 SD: 20.5 IW: 51
 Weight: 74 lbs Cube: 61.35

Standard Pillows: N/A Finish Req: Y
 Standard Cushions: Endurance Standard Finish:
 COM: 9 yards COL: N/A

D	E	F	G	H	J	K COM	L	M	N	O	P	Q	R	S	T	U	(# above U) *	S Nail	M Nail
3150	3174	3198	3222	3246	3270	3294	3318	3342	3366	3390	3414	3438	3462	3486	3510	3534	24 (Riser) + 3534 (U)	120	135
Leather 1 N/A		Leather 2 N/A		Leather 3 N/A		Leather 4 N/A		Leather 5 N/A		Leather 6 N/A		Leather 8 N/A		COL N/A		S Nail N/A		M Nail N/A	

Fabric SKU: 5751-40

Leather SKU: N/A

Bastille Settee

Width: 66.5 Depth: 31 Height: 40.5
 AH: 40.5 SH: 20 SD: 21.5 IW: 56
 Weight: 87 lbs Cube: 55.51

Standard Pillows: (2) 11 x 20 Kidney Finish Req: Y
 Standard Cushions: High Resiliency 40 Standard Finish:
 COM: 11 yards COL: N/A

D	E	F	G	H	J	K COM	L	M	N	O	P	Q	R	S	T	U	(# above U) *	S Nail	M Nail
3060	3090	3120	3150	3180	3210	3240	3270	3300	3330	3360	3390	3420	3450	3480	3510	3540	30 (Riser) + 3540 (U)	N/A	N/A
Leather 1 N/A		Leather 2 N/A		Leather 3 N/A		Leather 4 N/A		Leather 5 N/A		Leather 6 N/A		Leather 8 N/A		COL N/A		S Nail N/A		M Nail N/A	

Upholstery

**Pillows are not available on leather SKUs*

Fabric SKU: **6000-01**

Leather SKU: **L-6000-01**

Standard Pillows: N/A Finish Req: N

Standard Cushions: Classic Plush Standard Finish: Traditional

COM: 7 yards COL: 107 square feet

Lilly Lounge Chair

Width: 29.25 Depth: 35 Height: 34.5

AH: 24.5 SH: 20 SD: 23 IW: 22

Weight: 52 lbs Cube: 20.43

D	E	F	G	H	J	K COM	L	M	N	O	P	Q	R	S	T	U	(# above U) *	S Nail	M Nail
2325	2346	2367	2388	2409	2430	2451	2472	2493	2514	2535	2556	2577	2598	2619	2640	2661	21 (Riser) + 2661 (U)	N/A	N/A
Leather 1 3525		Leather 2 3690		Leather 3 3855		Leather 4 4020		Leather 5 4185		Leather 6 4350		Leather 8 5760		COL 2493		S Nail N/A		M Nail N/A	

Fabric SKU: **6000-31**

Leather SKU: **L-6000-31**

Standard Pillows: N/A Finish Req: N

Standard Cushions: Classic Plush Standard Finish:

COM: 7 yards COL: 107 square feet

Lilly Swivel Chair

Width: 29.25 Depth: 35 Height: 34.5

AH: 24.5 SH: 20 SD: 23 IW: 22

Weight: 52 lbs Cube: 20.43

D	E	F	G	H	J	K COM	L	M	N	O	P	Q	R	S	T	U	(# above U) *	S Nail	M Nail
2400	2421	2442	2463	2484	2505	2526	2547	2568	2589	2610	2631	2652	2673	2694	2715	2736	21 (Riser) + 2736 (U)	N/A	N/A
Leather 1 3600		Leather 2 3765		Leather 3 3930		Leather 4 4095		Leather 5 4260		Leather 6 4425		Leather 8 5835		COL 2568		S Nail N/A		M Nail N/A	

Fabric SKU: **6001-01**

Leather SKU: **L-6001-01**

Standard Pillows: N/A Finish Req: Y

Standard Cushions: High Resiliency 40 Standard Finish:

COM: 3.75 yards COL: 63 square feet

Lawrence Arm Chair

Width: 24.5 Depth: 30 Height: 42.5

AH: 26 SH: 20.5 SD: 20.5 IW: 20.5

Weight: 35 lbs Cube: 21.65

D	E	F	G	H	J	K COM	L	M	N	O	P	Q	R	S	T	U	(# above U) *	S Nail	M Nail
1650	1662	1674	1686	1698	1710	1722	1734	1746	1758	1770	1782	1794	1806	1818	1830	1842	12 (Riser) + 1842 (U)	45	60
Leather 1 2475		Leather 2 2580		Leather 3 2685		Leather 4 2790		Leather 5 2895		Leather 6 3000		Leather 8 3870		COL 1746		S Nail 45		M Nail 60	

Fabric SKU: **6001-A4**

Leather SKU: **L-6001-A4**

Standard Pillows: N/A Finish Req: Y

Standard Cushions: High Resiliency 40 Standard Finish:

COM: 3.75 yards COL: 70 square feet

Lawrence Arm Chair

Width: 24.5 Depth: 30 Height: 42.5

AH: 26 SH: 20.5 SD: 20.5 IW: 20.5

Weight: 35 lbs Cube: 26.89

D	E	F	G	H	J	K COM	L	M	N	O	P	Q	R	S	T	U	(# above U) *	S Nail	M Nail
1725	1737	1749	1761	1773	1785	1797	1809	1821	1833	1845	1857	1869	1881	1893	1905	1917	12 (Riser) + 1917 (U)	45	60
Leather 1 2550		Leather 2 2655		Leather 3 2760		Leather 4 2865		Leather 5 2970		Leather 6 3075		Leather 8 4035		COL 1821		S Nail 45		M Nail 60	

Fabric SKU: **6003-04**

Leather SKU: **N/A**

Standard Pillows: N/A Finish Req: N

Standard Cushions: High Resiliency 30 Standard Finish: Traditional

COM: 6.25 yards COL: N/A

Frame not warranted for Contract/Commercial application.

Chelsea Arm Chair

Width: 24.5 Depth: 28.5 Height: 42.5

AH: 27 SH: 20.5 SD: 18 IW: 18

Weight: 40 lbs Cube: 26.89

D	E	F	G	H	J	K COM	L	M	N	O	P	Q	R	S	T	U	(# above U) *	S Nail	M Nail
1845	1863	1881	1899	1917	1935	1953	1971	1989	2007	2025	2043	2061	2079	2097	2115	2133	18 (Riser) + 2133 (U)	N/A	N/A
Leather 1 N/A		Leather 2 N/A		Leather 3 N/A		Leather 4 N/A		Leather 5 N/A		Leather 6 N/A		Leather 8 N/A		COL N/A		S Nail N/A		M Nail N/A	

Fabric SKU: **6007-04**

Leather SKU: **L-6007-04**

Standard Pillows: N/A Finish Req: Y

Standard Cushions: High Resiliency 40 Standard Finish:

COM: 2.75 yards COL: 57 square feet

Features Clean Out at back of seat

Niobi Arm Chair

Clean Out Seat

Width: 24.5 Depth: 23.5 Height: 33

AH: 25 SH: 19 SD: 18 IW: 20

Weight: 25 lbs Cube: 15.74

D	E	F	G	H	J	K COM	L	M	N	O	P	Q	R	S	T	U	(# above U) *	S Nail	M Nail
1725	1734	1743	1752	1761	1770	1779	1788	1797	1806	1815	1824	1833	1842	1851	1860	1869	9 (Riser) + 1869 (U)	N/A	N/A
Leather 1 2250		Leather 2 2340		Leather 3 2430		Leather 4 2520		Leather 5 2610		Leather 6 2700		Leather 8 3495		COL 1797		S Nail N/A		M Nail N/A	

Upholstery

**Pillows are not available on leather SKUs*

Fabric SKU: **6007-A2**

Leather SKU: **L-6007-A2**

Standard Pillows: N/A Finish Req: Y

Standard Cushions: High Resiliency 40 Standard Finish:

COM: 2.75 yards COL: 57 square feet

Features Clean Out at back of seat. Standard with 2 front casters

Niobi Arm Chair

Two Casters, Clean Out Seat

Width: 24.5 Depth: 23.5 Height: 33

AH: 25 SH: 19 SD: 18 IW: 20

Weight: 25 lbs Cube: 15.74

D	E	F	G	H	J	K COM	L	M	N	O	P	Q	R	S	T	U	(# above U) *	S Nail	M Nail
1761	1770	1779	1788	1797	1806	1815	1824	1833	1842	1851	1860	1869	1878	1887	1896	1905	9 (Riser) + 1905 (U)	N/A	N/A
Leather 1 2280		Leather 2 2370		Leather 3 2460		Leather 4 2550		Leather 5 2640		Leather 6 2730		Leather 8 3525		COL 1833		S Nail N/A		M Nail N/A	

Fabric SKU: **6007-A4**

Leather SKU: **L-6007-A4**

Standard Pillows: N/A Finish Req: Y

Standard Cushions: High Resiliency 40 Standard Finish:

COM: 2.75 yards COL: 57 square feet

Features Clean Out at back of seat. Standard with 4 casters

Niobi Arm Chair

Four Casters, Clean Out Seat

Width: 24.5 Depth: 23.5 Height: 33

AH: 25 SH: 19 SD: 18 IW: 20

Weight: 25 lbs Cube: 15.74

D	E	F	G	H	J	K COM	L	M	N	O	P	Q	R	S	T	U	(# above U) *	S Nail	M Nail
1797	1806	1815	1824	1833	1842	1851	1860	1869	1878	1887	1896	1905	1914	1923	1932	1941	9 (Riser) + 1941 (U)	N/A	N/A
Leather 1 2325		Leather 2 2415		Leather 3 2505		Leather 4 2595		Leather 5 2685		Leather 6 2775		Leather 8 3570		COL 1869		S Nail N/A		M Nail N/A	

Fabric SKU: **6011-01**

Leather SKU: **L-6011-01**

Standard Pillows: N/A Finish Req: Y

Standard Cushions: Ultra Plush Standard Finish:

COM: 4.5 yards COL: 76.5 square feet

Gladstone Occasional Chair

Width: 27 Depth: 30 Height: 38.5

AH: 25.5 SH: 21 SD: 21 IW: 22

Weight: 45 lbs Cube: 23.53

D	E	F	G	H	J	K COM	L	M	N	O	P	Q	R	S	T	U	(# above U) *	S Nail	M Nail
1920	1935	1950	1965	1980	1995	2010	2025	2040	2055	2070	2085	2100	2115	2130	2145	2160	15 (Riser) + 2160 (U)	45	60
Leather 1 2955		Leather 2 3075		Leather 3 3195		Leather 4 3315		Leather 5 3435		Leather 6 3555		Leather 8 4605		COL 2040		S Nail 45		M Nail 60	

Fabric SKU: **6011-20**

Leather SKU: **L-6011-20**

Standard Pillows: N/A Finish Req: Y

Standard Cushions: High Resiliency 30 Standard Finish:

COM: 2.75 yards COL: 48.6 square feet

Gladstone Ottoman

Width: 26 Depth: 21 Height: 18.5

AH: 0 SH: 0 SD: 0 IW: 0

Weight: 20 lbs Cube: 10.77

D	E	F	G	H	J	K COM	L	M	N	O	P	Q	R	S	T	U	(# above U) *	S Nail	M Nail
1125	1134	1143	1152	1161	1170	1179	1188	1197	1206	1215	1224	1233	1242	1251	1260	1269	9 (Riser) + 1269 (U)	30	45
Leather 1 1875		Leather 2 1950		Leather 3 2025		Leather 4 2100		Leather 5 2175		Leather 6 2250		Leather 8 2925		COL 1197		S Nail 30		M Nail 45	

Fabric SKU: **6012-01**

Leather SKU: **L-6012-01**

Standard Pillows: N/A Finish Req: Y

Standard Cushions: High Resiliency 40 Standard Finish:

COM: 3.75 yards COL: 62 square feet

Layne Occasional Chair

Width: 31 Depth: 34 Height: 33

AH: 20 SH: 18 SD: 20.5 IW: 26.5

Weight: 31 lbs Cube: 23.89

D	E	F	G	H	J	K COM	L	M	N	O	P	Q	R	S	T	U	(# above U) *	S Nail	M Nail
2145	2157	2169	2181	2193	2205	2217	2229	2241	2253	2265	2277	2289	2301	2313	2325	2337	12 (Riser) + 2337 (U)	N/A	N/A
Leather 1 2940		Leather 2 3045		Leather 3 3150		Leather 4 3255		Leather 5 3360		Leather 6 3465		Leather 8 4320		COL 2241		S Nail N/A		M Nail N/A	

Fabric SKU: **6013-04**

Leather SKU: **L-6013-04**

Standard Pillows: N/A Finish Req: Y

Standard Cushions: High Resiliency 30 Standard Finish:

COM: 4.5 yards COL: 74 square feet

Haines Arm Chair

Width: 26 Depth: 28.5 Height: 42.5

AH: 27 SH: 20.5 SD: 18 IW: 18

Weight: 40 lbs Cube: 26.89

D	E	F	G	H	J	K COM	L	M	N	O	P	Q	R	S	T	U	(# above U) *	S Nail	M Nail
1680	1692	1704	1716	1728	1740	1752	1764	1776	1788	1800	1812	1824	1836	1848	1860	1872	12 (Riser) + 1872 (U)	45	60
Leather 1 2640		Leather 2 2760		Leather 3 2880		Leather 4 3000		Leather 5 3120		Leather 6 3240		Leather 8 4260		COL 1776		S Nail 45		M Nail 60	

Upholstery

**Pillows are not available on leather SKUs*

Fabric SKU: **6014-01**

Leather SKU: **L-6014-01**

Standard Pillows: N/A Finish Req: Y

Standard Cushions: High Resiliency 40 Standard Finish:

COM: 3.75 yards COL: 62 square feet

Aiden Occasional Chair

Width: 26 Depth: 26.5 Height: 32

AH: 24 SH: 20 SD: 19.5 IW: 19

Weight: 29 lbs Cube: 21.65

D	E	F	G	H	J	K COM	L	M	N	O	P	Q	R	S	T	U	(# above U) *	S Nail	M Nail
1590	1602	1614	1626	1638	1650	1662	1674	1686	1698	1710	1722	1734	1746	1758	1770	1782	12 (Riser) + 1782 (U)	60	75
Leather 1 2235		Leather 2 2340		Leather 3 2445		Leather 4 2550		Leather 5 2655		Leather 6 2760		Leather 8 3615		COL 1686		S Nail 60		M Nail 75	

Fabric SKU: **6014-A2**

Leather SKU: **L-6014-A2**

Standard Pillows: N/A Finish Req: Y

Standard Cushions: High Resiliency 40 Standard Finish:

COM: 3.75 yards COL: 59.5 square feet

Aiden Occasional Chair

Width: 26 Depth: 26.5 Height: 32

AH: 24 SH: 20 SD: 19.5 IW: 19

Weight: 29 lbs Cube: 21.65

D	E	F	G	H	J	K COM	L	M	N	O	P	Q	R	S	T	U	(# above U) *	S Nail	M Nail
1626	1638	1650	1662	1674	1686	1698	1710	1722	1734	1746	1758	1770	1782	1794	1806	1818	12 (Riser) + 1818 (U)	60	75
Leather 1 2265		Leather 2 2355		Leather 3 2445		Leather 4 2535		Leather 5 2625		Leather 6 2715		Leather 8 3540		COL 1722		S Nail 60		M Nail 75	

Fabric SKU: **6014-A4**

Leather SKU: **L-6014-A4**

Standard Pillows: N/A Finish Req: Y

Standard Cushions: High Resiliency 40 Standard Finish:

COM: 3.75 yards COL: 59.5 square feet

Aiden Occasional Chair

Width: 26 Depth: 26.5 Height: 32

AH: 24 SH: 20 SD: 19.5 IW: 19

Weight: 27 lbs Cube: 21.65

D	E	F	G	H	J	K COM	L	M	N	O	P	Q	R	S	T	U	(# above U) *	S Nail	M Nail
1662	1674	1686	1698	1710	1722	1734	1746	1758	1770	1782	1794	1806	1818	1830	1842	1854	12 (Riser) + 1854 (U)	60	75
Leather 1 2310		Leather 2 2400		Leather 3 2490		Leather 4 2580		Leather 5 2670		Leather 6 2760		Leather 8 3585		COL 1758		S Nail 60		M Nail 75	

Fabric SKU: **6016-01**

Leather SKU: **L-6016-01**

Standard Pillows: N/A Finish Req: Y

Standard Cushions: High Resiliency 40 Standard Finish:

COM: 2 yards COL: 34.2 square feet

Lockport Occasional Chair

Width: 23.5 Depth: 25 Height: 32

AH: 25.5 SH: 19 SD: 20 IW: 19

Weight: 25 lbs Cube: 15.74

D	E	F	G	H	J	K COM	L	M	N	O	P	Q	R	S	T	U	(# above U) *	S Nail	M Nail
1290	1296	1302	1308	1314	1320	1326	1332	1338	1344	1350	1356	1362	1368	1374	1380	1386	6 (Riser) + 1386 (U)	N/A	N/A
Leather 1 1770		Leather 2 1830		Leather 3 1890		Leather 4 1950		Leather 5 2010		Leather 6 2070		Leather 8 2550		COL 1338		S Nail N/A		M Nail N/A	

Fabric SKU: **6018-04**

Leather SKU: **L-6018-04**

Standard Pillows: N/A Finish Req: Y

Standard Cushions: High Resiliency 40 Standard Finish:

COM: 5.5 yards COL: 90.95 square feet

Dora Arm Chair

Width: 24.5 Depth: 29 Height: 44

AH: 24 SH: 21 SD: 18.5 IW: 19

Weight: 40 lbs Cube: 24.14

D	E	F	G	H	J	K COM	L	M	N	O	P	Q	R	S	T	U	(# above U) *	S Nail	M Nail
1590	1605	1620	1635	1650	1665	1680	1695	1710	1725	1740	1755	1770	1785	1800	1815	1830	15 (Riser) + 1830 (U)	60	75
Leather 1 2805		Leather 2 2940		Leather 3 3075		Leather 4 3210		Leather 5 3345		Leather 6 3480		Leather 8 4740		COL 1710		S Nail 60		M Nail 75	

Fabric SKU: **6018-05**

Leather SKU: **L-6018-05**

Standard Pillows: N/A Finish Req: Y

Standard Cushions: High Resiliency 40 Standard Finish:

COM: 4.75 yards COL: 74 square feet

Dora Side Chair

Width: 21 Depth: 29 Height: 44

AH: 0 SH: 21 SD: 18.5 IW: 0

Weight: 30 lbs Cube: 24.14

D	E	F	G	H	J	K COM	L	M	N	O	P	Q	R	S	T	U	(# above U) *	S Nail	M Nail
1485	1500	1515	1530	1545	1560	1575	1590	1605	1620	1635	1650	1665	1680	1695	1710	1725	15 (Riser) + 1725 (U)	60	75
Leather 1 2490		Leather 2 2610		Leather 3 2730		Leather 4 2850		Leather 5 2970		Leather 6 3090		Leather 8 4110		COL 1605		S Nail 60		M Nail 75	

Upholstery

**Pillows are not available on leather SKUs*

Fabric SKU: **6018-07**

Leather SKU: **L-6018-07**

Standard Pillows: N/A Finish Req: Y

Standard Cushions: High Resiliency 40 Standard Finish:

COM: 3.5 yards COL: 57.6 square feet

Dora Bar Stool

Width: 20.5 Depth: 25 Height: 46

AH: 0 SH: 30.5 SD: 17.5 IW: 20.5

Weight: 25 lbs Cube: 19.6

D	E	F	G	H	J	K COM	L	M	N	O	P	Q	R	S	T	U	(# above U) *	S Nail	M Nail
1545	1554	1563	1572	1581	1590	1599	1608	1617	1626	1635	1644	1653	1662	1671	1680	1689	9 (Riser) + 1689 (U)	45	60
Leather 1 2295		Leather 2 2385		Leather 3 2475		Leather 4 2565		Leather 5 2655		Leather 6 2745		Leather 8 3540		COL 1617		S Nail 45		M Nail 60	

Fabric SKU: **6018-40**

Leather SKU: **N/A**

Standard Pillows: N/A Finish Req: Y

Standard Cushions: High Resiliency 40 Standard Finish:

COM: 6.5 yards COL: N/A

Dora Settee

Width: 55.5 Depth: 29 Height: 44

AH: 24 SH: 20.75 SD: 18.5 IW: 50

Weight: 54 lbs Cube: 44.07

D	E	F	G	H	J	K COM	L	M	N	O	P	Q	R	S	T	U	(# above U) *	S Nail	M Nail
2250	2271	2292	2313	2334	2355	2376	2397	2418	2439	2460	2481	2502	2523	2544	2565	2586	21 (Riser) + 2586 (U)	105	120
Leather 1 N/A		Leather 2 N/A		Leather 3 N/A		Leather 4 N/A		Leather 5 N/A		Leather 6 N/A		Leather 8 N/A		COL N/A		S Nail N/A		M Nail N/A	

Fabric SKU: **6018-C7**

Leather SKU: **L-6018-C7**

Standard Pillows: N/A Finish Req: Y

Standard Cushions: High Resiliency 40 Standard Finish:

COM: 3.5 yards COL: 57.6 square feet

Dora Counter Stool

Width: 20.5 Depth: 25 Height: 42

AH: 0 SH: 26.5 SD: 17.5 IW: 20.5

Weight: 30 lbs Cube: 17.77

D	E	F	G	H	J	K COM	L	M	N	O	P	Q	R	S	T	U	(# above U) *	S Nail	M Nail
1545	1554	1563	1572	1581	1590	1599	1608	1617	1626	1635	1644	1653	1662	1671	1680	1689	9 (Riser) + 1689 (U)	45	60
Leather 1 2295		Leather 2 2385		Leather 3 2475		Leather 4 2565		Leather 5 2655		Leather 6 2745		Leather 8 3540		COL 1617		S Nail 45		M Nail 60	

Fabric SKU: **6019-40**

Leather SKU: **N/A**

Standard Pillows: N/A Finish Req: Y

Standard Cushions: High Resiliency 40 Standard Finish:

COM: 6.5 yards COL: N/A

Standard with contrasting centered stripe application with any fabric.

Dora Settee

Width: 55.5 Depth: 29 Height: 44

AH: 24 SH: 20.75 SD: 18.5 IW: 50

Weight: 54 lbs Cube: 40.98

D	E	F	G	H	J	K COM	L	M	N	O	P	Q	R	S	T	U	(# above U) *	S Nail	M Nail
2250	2271	2292	2313	2334	2355	2376	2397	2418	2439	2460	2481	2502	2523	2544	2565	2586	21 (Riser) + 2586 (U)	105	120
Leather 1 N/A		Leather 2 N/A		Leather 3 N/A		Leather 4 N/A		Leather 5 N/A		Leather 6 N/A		Leather 8 N/A		COL N/A		S Nail N/A		M Nail N/A	

Fabric SKU: **6024-01**

Leather SKU: **L-6024-01**

Standard Pillows: N/A Finish Req: Y

Standard Cushions: High Resiliency 35 Standard Finish:

COM: 5.25 yards COL: 102 square feet

Papillon Lounge Chair

Width: 33 Depth: 32 Height: 37

AH: 24 SH: 20.5 SD: 18 IW: 25

Weight: 80 lbs Cube: 22.61

D	E	F	G	H	J	K COM	L	M	N	O	P	Q	R	S	T	U	(# above U) *	S Nail	M Nail
2325	2343	2361	2379	2397	2415	2433	2451	2469	2487	2505	2523	2541	2559	2577	2595	2613	18 (Riser) + 2613 (U)	75	N/A
Leather 1 3450		Leather 2 3600		Leather 3 3750		Leather 4 3900		Leather 5 4050		Leather 6 4200		Leather 8 5520		COL 2469		S Nail 75		M Nail N/A	

Fabric SKU: **6024-31**

Leather SKU: **L-6024-31**

Standard Pillows: N/A Finish Req: Y

Standard Cushions: High Resiliency 35 Standard Finish:

COM: 5.25 yards COL: 102 square feet

Papillon Swivel Chair

Width: 33 Depth: 32 Height: 37

AH: 24 SH: 20.5 SD: 18 IW: 25

Weight: 80 lbs Cube: 22.61

D	E	F	G	H	J	K COM	L	M	N	O	P	Q	R	S	T	U	(# above U) *	S Nail	M Nail
2400	2418	2436	2454	2472	2490	2508	2526	2544	2562	2580	2598	2616	2634	2652	2670	2688	18 (Riser) + 2688 (U)	75	N/A
Leather 1 3525		Leather 2 3675		Leather 3 3825		Leather 4 3975		Leather 5 4125		Leather 6 4275		Leather 8 5595		COL 2544		S Nail 75		M Nail N/A	

Upholstery

**Pillows are not available on leather SKUs*

Fabric SKU: **6029-01**

Leather SKU: **L-6029-01**

Standard Pillows: N/A Finish Req: Y

Standard Cushions: High Resiliency 40 Standard Finish:

COM: 3.25 yards COL: 53.1 square feet

Brayden Occasional Chair

Width: 27 Depth: 29 Height: 31

AH: 26 SH: 18 SD: 21 IW: 24.5

Weight: 32 lbs Cube: 23.89

D	E	F	G	H	J	K COM	L	M	N	O	P	Q	R	S	T	U	(# above U) *	S Nail	M Nail
1680	1695	1710	1725	1740	1755	1770	1785	1800	1815	1830	1845	1860	1875	1890	1905	1920	15 (Riser) + 1920 (U)	N/A	N/A
Leather 1 2400		Leather 2 2490		Leather 3 2580		Leather 4 2670		Leather 5 2760		Leather 6 2850		Leather 8 3585		COL 1800		S Nail N/A		M Nail N/A	

Fabric SKU: **6029-A2**

Leather SKU: **L-6029-A2**

Standard Pillows: N/A Finish Req: Y

Standard Cushions: High Resiliency 40 Standard Finish:

COM: 3.25 yards COL: 53.1 square feet

Brayden Occasional Chair

Width: 27 Depth: 29 Height: 31

AH: 26 SH: 18 SD: 21 IW: 24.5

Weight: 32 lbs Cube: 21.65

D	E	F	G	H	J	K COM	L	M	N	O	P	Q	R	S	T	U	(# above U) *	S Nail	M Nail
1725	1740	1755	1770	1785	1800	1815	1830	1845	1860	1875	1890	1905	1920	1935	1950	1965	15 (Riser) + 1965 (U)	N/A	N/A
Leather 1 2445		Leather 2 2535		Leather 3 2625		Leather 4 2715		Leather 5 2805		Leather 6 2895		Leather 8 3630		COL 1845		S Nail N/A		M Nail N/A	

Fabric SKU: **6029-A4**

Leather SKU: **L-6029-A4**

Standard Pillows: N/A Finish Req: Y

Standard Cushions: High Resiliency 40 Standard Finish:

COM: 3.25 yards COL: 53.1 square feet

Brayden Occasional Chair

Width: 27 Depth: 29 Height: 31

AH: 26 SH: 18 SD: 21 IW: 24.5

Weight: 32 lbs Cube: 23.89

D	E	F	G	H	J	K COM	L	M	N	O	P	Q	R	S	T	U	(# above U) *	S Nail	M Nail
1770	1785	1800	1815	1830	1845	1860	1875	1890	1905	1920	1935	1950	1965	1980	1995	2010	15 (Riser) + 2010 (U)	N/A	N/A
Leather 1 2490		Leather 2 2580		Leather 3 2670		Leather 4 2760		Leather 5 2850		Leather 6 2940		Leather 8 3675		COL 1890		S Nail N/A		M Nail N/A	

Fabric SKU: **6037-01**

Leather SKU: **L-6037-01**

Standard Pillows: N/A Finish Req: Y

Standard Cushions: High Resiliency 35 Standard Finish:

COM: 4.25 yards COL: 85 square feet

Dhalia Lounge Chair

Width: 32 Depth: 37 Height: 31.5

AH: 28 SH: 18 SD: 24 IW: 22

Weight: 80 lbs Cube: 21.58

D	E	F	G	H	J	K COM	L	M	N	O	P	Q	R	S	T	U	(# above U) *	S Nail	M Nail
2100	2112	2124	2136	2148	2160	2172	2184	2196	2208	2220	2232	2244	2256	2268	2280	2292	12 (Riser) + 2292 (U)	45	N/A
Leather 1 3210		Leather 2 3345		Leather 3 3480		Leather 4 3615		Leather 5 3750		Leather 6 3885		Leather 8 5055		COL 2196		S Nail 45		M Nail N/A	

Fabric SKU: **6037-01-2**

Leather SKU: **L-6037-01-2**

Standard Pillows: N/A Finish Req: N

Standard Cushions: High Resiliency 35 Standard Finish: Nickel

COM: 4.25 yards COL: 85 square feet

Dhalia Lounge Chair

Nickel Metal Base

Width: 32 Depth: 37 Height: 31.5

AH: 28 SH: 18 SD: 24 IW: 22

Weight: 80 lbs Cube: 21.58

D	E	F	G	H	J	K COM	L	M	N	O	P	Q	R	S	T	U	(# above U) *	S Nail	M Nail
2400	2412	2424	2436	2448	2460	2472	2484	2496	2508	2520	2532	2544	2556	2568	2580	2592	12 (Riser) + 2592 (U)	45	N/A
Leather 1 3510		Leather 2 3645		Leather 3 3780		Leather 4 3915		Leather 5 4050		Leather 6 4185		Leather 8 5355		COL 2496		S Nail 45		M Nail N/A	

Fabric SKU: **6037-01-7**

Leather SKU: **L-6037-01-7**

Standard Pillows: N/A Finish Req: N

Standard Cushions: High Resiliency 35 Standard Finish: Bright Brass

COM: 4.25 yards COL: 85 square feet

Dhalia Lounge Chair

Bright Brass Metal Base

Width: 32 Depth: 37 Height: 31.5

AH: 28 SH: 18 SD: 24 IW: 22

Weight: 80 lbs Cube: 21.58

D	E	F	G	H	J	K COM	L	M	N	O	P	Q	R	S	T	U	(# above U) *	S Nail	M Nail
2400	2412	2424	2436	2448	2460	2472	2484	2496	2508	2520	2532	2544	2556	2568	2580	2592	12 (Riser) + 2592 (U)	45	N/A
Leather 1 3510		Leather 2 3645		Leather 3 3780		Leather 4 3915		Leather 5 4050		Leather 6 4185		Leather 8 5355		COL 2496		S Nail 45		M Nail N/A	

Upholstery

**Pillows are not available on leather SKUs*

Fabric SKU: 6037-31

Leather SKU: L-6037-31

Standard Pillows: N/A Finish Req: Y

Standard Cushions: High Resiliency 35 Standard Finish:

COM: 4.25 yards COL: 85 square feet

Dhalia Swivel Chair

Width: 32 Depth: 37 Height: 31.5

AH: 28 SH: 18 SD: 24 IW: 22

Weight: 80 lbs Cube: 21.58

D	E	F	G	H	J	K COM	L	M	N	O	P	Q	R	S	T	U	(# above U) *	S Nail	M Nail
2175	2187	2199	2211	2223	2235	2247	2259	2271	2283	2295	2307	2319	2331	2343	2355	2367	12 (Riser) + 2367 (U)	45	N/A
Leather 1 3285		Leather 2 3420		Leather 3 3555		Leather 4 3690		Leather 5 3825		Leather 6 3960		Leather 8 5130		COL 2271		S Nail 45		M Nail N/A	

Fabric SKU: 6037-31-2

Leather SKU: L-6037-31-2

Standard Pillows: N/A Finish Req: N

Standard Cushions: High Resiliency 35 Standard Finish: Nickel

COM: 4.25 yards COL: 85 square feet

Dhalia Swivel Chair

Nickel Metal Base

Width: 32 Depth: 37 Height: 31.5

AH: 28 SH: 18 SD: 24 IW: 22

Weight: 80 lbs Cube: 21.58

D	E	F	G	H	J	K COM	L	M	N	O	P	Q	R	S	T	U	(# above U) *	S Nail	M Nail
2475	2487	2499	2511	2523	2535	2547	2559	2571	2583	2595	2607	2619	2631	2643	2655	2667	12 (Riser) + 2667 (U)	45	N/A
Leather 1 3585		Leather 2 3720		Leather 3 3855		Leather 4 3990		Leather 5 4125		Leather 6 4260		Leather 8 5430		COL 2571		S Nail 45		M Nail N/A	

Fabric SKU: 6037-31-7

Leather SKU: L-6037-31-7

Standard Pillows: N/A Finish Req: N

Standard Cushions: High Resiliency 35 Standard Finish: Bright Brass

COM: 4.25 yards COL: 85 square feet

Dhalia Swivel Chair

Bright Brass Metal Base

Width: 32 Depth: 37 Height: 31.5

AH: 28 SH: 18 SD: 24 IW: 22

Weight: 80 lbs Cube: 21.58

D	E	F	G	H	J	K COM	L	M	N	O	P	Q	R	S	T	U	(# above U) *	S Nail	M Nail
2475	2487	2499	2511	2523	2535	2547	2559	2571	2583	2595	2607	2619	2631	2643	2655	2667	12 (Riser) + 2667 (U)	45	N/A
Leather 1 3585		Leather 2 3720		Leather 3 3855		Leather 4 3990		Leather 5 4125		Leather 6 4260		Leather 8 5430		COL 2571		S Nail 45		M Nail N/A	

Fabric SKU: 6038-04

Leather SKU: L-6038-04

Standard Pillows: N/A Finish Req: Y

Standard Cushions: High Resiliency 40 Standard Finish:

COM: 3.25 yards COL: 57 square feet

Dena Arm Chair

Width: 24 Depth: 26 Height: 38

AH: 24.5 SH: 19.5 SD: 17.5 IW: 19

Weight: 26 lbs Cube: 13.72

D	E	F	G	H	J	K COM	L	M	N	O	P	Q	R	S	T	U	(# above U) *	S Nail	M Nail
1350	1359	1368	1377	1386	1395	1404	1413	1422	1431	1440	1449	1458	1467	1476	1485	1494	9 (Riser) + 1494 (U)	60	75
Leather 1 2145		Leather 2 2235		Leather 3 2325		Leather 4 2415		Leather 5 2505		Leather 6 2595		Leather 8 3390		COL 1422		S Nail 60		M Nail 75	

Fabric SKU: 6038-04-M

Leather SKU: L-6038-04-M

Standard Pillows: N/A Finish Req: N

Standard Cushions: High Resiliency 40 Standard Finish: Mica

COM: 3.25 yards COL: 57 square feet

Dena Arm Chair

Mica Finish

Width: 24 Depth: 26 Height: 38

AH: 24.5 SH: 19.5 SD: 17.5 IW: 19

Weight: 26 lbs Cube: 13.72

D	E	F	G	H	J	K COM	L	M	N	O	P	Q	R	S	T	U	(# above U) *	S Nail	M Nail
1185	1194	1203	1212	1221	1230	1239	1248	1257	1266	1275	1284	1293	1302	1311	1320	1329	9 (Riser) + 1329 (U)	60	75
Leather 1 2025		Leather 2 2115		Leather 3 2205		Leather 4 2295		Leather 5 2385		Leather 6 2475		Leather 8 3270		COL 1257		S Nail 60		M Nail 75	

Fabric SKU: 6038-05

Leather SKU: L-6038-05

Standard Pillows: N/A Finish Req: Y

Standard Cushions: High Resiliency 40 Standard Finish:

COM: 2.75 yards COL: 57 square feet

Dena Side Chair

Width: 22 Depth: 26 Height: 38

AH: 0 SH: 19.5 SD: 16.75 IW: 17.5

Weight: 23 lbs Cube: 12.57

D	E	F	G	H	J	K COM	L	M	N	O	P	Q	R	S	T	U	(# above U) *	S Nail	M Nail
1275	1284	1293	1302	1311	1320	1329	1338	1347	1356	1365	1374	1383	1392	1401	1410	1419	9 (Riser) + 1419 (U)	60	75
Leather 1 2070		Leather 2 2160		Leather 3 2250		Leather 4 2340		Leather 5 2430		Leather 6 2520		Leather 8 3315		COL 1347		S Nail 60		M Nail 75	

Upholstery

**Pillows are not available on leather SKUs*

Fabric SKU: **6038-05-M**

Leather SKU: **L-6038-05-M**

Standard Pillows: N/A **Finish Req:** N

Standard Cushions: High Resiliency 40 **Standard Finish:** Mica

COM: 2.75 yards **COL:** 57 square feet

Dena Side Chair

Mica Finish

Width: 22 **Depth:** 26 **Height:** 38

AH: 0 **SH:** 19.5 **SD:** 16.75 **IW:** 17.5

Weight: 23 lbs **Cube:** 12.57

D	E	F	G	H	J	K COM	L	M	N	O	P	Q	R	S	T	U	(# above U) *	S Nail	M Nail
1110	1119	1128	1137	1146	1155	1164	1173	1182	1191	1200	1209	1218	1227	1236	1245	1254	9 (Riser) + 1254 (U)	60	75
Leather 1 1950		Leather 2 2040		Leather 3 2130		Leather 4 2220		Leather 5 2310		Leather 6 2400		Leather 8 3195		COL 1182		S Nail 60		M Nail 75	

Fabric SKU: **6038-A2**

Leather SKU: **L-6038-A2**

Standard Pillows: N/A **Finish Req:** Y

Standard Cushions: High Resiliency 40 **Standard Finish:**

COM: 3.25 yards **COL:** 57 square feet

Dena Arm Chair

with two front casters

Width: 24 **Depth:** 26 **Height:** 38

AH: 24.5 **SH:** 19.5 **SD:** 17.5 **IW:** 19

Weight: 26 lbs **Cube:** 13.72

D	E	F	G	H	J	K COM	L	M	N	O	P	Q	R	S	T	U	(# above U) *	S Nail	M Nail
1386	1395	1404	1413	1422	1431	1440	1449	1458	1467	1476	1485	1494	1503	1512	1521	1530	9 (Riser) + 1530 (U)	60	75
Leather 1 2175		Leather 2 2265		Leather 3 2355		Leather 4 2445		Leather 5 2535		Leather 6 2625		Leather 8 3420		COL 1458		S Nail 60		M Nail 75	

Fabric SKU: **6038-A2-M**

Leather SKU: **L-6038-A2-M**

Standard Pillows: N/A **Finish Req:** N

Standard Cushions: High Resiliency 40 **Standard Finish:** Mica

COM: 3.25 yards **COL:** 57 square feet

Dena Arm Chair

with two front casters, Mica Finish

Width: 24 **Depth:** 26 **Height:** 38

AH: 24.5 **SH:** 19.5 **SD:** 17.5 **IW:** 19

Weight: 26 lbs **Cube:** 13.72

D	E	F	G	H	J	K COM	L	M	N	O	P	Q	R	S	T	U	(# above U) *	S Nail	M Nail
1221	1230	1239	1248	1257	1266	1275	1284	1293	1302	1311	1320	1329	1338	1347	1356	1365	9 (Riser) + 1365 (U)	60	75
Leather 1 2055		Leather 2 2145		Leather 3 2235		Leather 4 2325		Leather 5 2415		Leather 6 2505		Leather 8 3300		COL 1293		S Nail 60		M Nail 75	

Fabric SKU: **6038-A4**

Leather SKU: **L-6038-A4**

Standard Pillows: N/A **Finish Req:** Y

Standard Cushions: High Resiliency 40 **Standard Finish:**

COM: 3.25 yards **COL:** 57 square feet

Dena Arm Chair

with four casters

Width: 24 **Depth:** 26 **Height:** 38

AH: 24.5 **SH:** 19.5 **SD:** 17.5 **IW:** 19

Weight: 26 lbs **Cube:** 13.72

D	E	F	G	H	J	K COM	L	M	N	O	P	Q	R	S	T	U	(# above U) *	S Nail	M Nail
1422	1431	1440	1449	1458	1467	1476	1485	1494	1503	1512	1521	1530	1539	1548	1557	1566	9 (Riser) + 1566 (U)	60	75
Leather 1 2220		Leather 2 2310		Leather 3 2400		Leather 4 2490		Leather 5 2580		Leather 6 2670		Leather 8 3465		COL 1494		S Nail 60		M Nail 75	

Fabric SKU: **6038-A4-M**

Leather SKU: **L-6038-A4-M**

Standard Pillows: N/A **Finish Req:** N

Standard Cushions: High Resiliency 40 **Standard Finish:** Mica

COM: 3.25 yards **COL:** 57 square feet

Dena Arm Chair

with four casters, Mica Finish

Width: 24 **Depth:** 26 **Height:** 38

AH: 24.5 **SH:** 19.5 **SD:** 17.5 **IW:** 19

Weight: 26 lbs **Cube:** 13.72

D	E	F	G	H	J	K COM	L	M	N	O	P	Q	R	S	T	U	(# above U) *	S Nail	M Nail
1257	1266	1275	1284	1293	1302	1311	1320	1329	1338	1347	1356	1365	1374	1383	1392	1401	9 (Riser) + 1401 (U)	60	75
Leather 1 2100		Leather 2 2190		Leather 3 2280		Leather 4 2370		Leather 5 2460		Leather 6 2550		Leather 8 3345		COL 1329		S Nail 60		M Nail 75	

Fabric SKU: **6044-01**

Leather SKU: **L-6044-01**

Standard Pillows: N/A **Finish Req:** Y

Standard Cushions: High Resiliency 30 **Standard Finish:**

COM: 4.25 yards **COL:** 74 square feet

Lillian Occasional Chair

Width: 28 **Depth:** 31 **Height:** 34

AH: 24 **SH:** 18.25 **SD:** 22 **IW:** 20

Weight: 41 lbs **Cube:** 17.07

D	E	F	G	H	J	K COM	L	M	N	O	P	Q	R	S	T	U	(# above U) *	S Nail	M Nail
1650	1662	1674	1686	1698	1710	1722	1734	1746	1758	1770	1782	1794	1806	1818	1830	1842	12 (Riser) + 1842 (U)	75	N/A
Leather 1 2385		Leather 2 2505		Leather 3 2625		Leather 4 2745		Leather 5 2865		Leather 6 2985		Leather 8 4005		COL 1746		S Nail 75		M Nail N/A	

Upholstery

**Pillows are not available on leather SKUs*

Fabric SKU: **6044-01-M**

Leather SKU: **L-6044-01-M**

Standard Pillows: N/A Finish Req: N

Standard Cushions: High Resiliency 30 Standard Finish: Mica

COM: 4.25 yards COL: 74 square feet

Lillian Occasional Chair

Mica Finish

Width: 28 Depth: 31 Height: 34

AH: 24 SH: 18.25 SD: 22 IW: 20

Weight: 41 lbs Cube: 17.07

D	E	F	G	H	J	K COM	L	M	N	O	P	Q	R	S	T	U	(# above U) *	S Nail	M Nail
1485	1497	1509	1521	1533	1545	1557	1569	1581	1593	1605	1617	1629	1641	1653	1665	1677	12 (Riser) + 1677 (U)	75	N/A
Leather 1 2250		Leather 2 2370		Leather 3 2490		Leather 4 2610		Leather 5 2730		Leather 6 2850		Leather 8 3870		COL 1581		S Nail 75		M Nail N/A	

Fabric SKU: **6046-01**

Leather SKU: **L-6046-01**

Standard Pillows: N/A Finish Req: Y

Standard Cushions: High Resiliency 40 Standard Finish:

COM: 3.25 yards COL: 62 square feet

Gresham Occasional Chair

Width: 28.5 Depth: 24.5 Height: 33

AH: 26 SH: 20 SD: 19 IW: 20

Weight: 25 lbs Cube: 21.65

D	E	F	G	H	J	K COM	L	M	N	O	P	Q	R	S	T	U	(# above U) *	S Nail	M Nail
1725	1734	1743	1752	1761	1770	1779	1788	1797	1806	1815	1824	1833	1842	1851	1860	1869	9 (Riser) + 1869 (U)	45	N/A
Leather 1 2475		Leather 2 2580		Leather 3 2685		Leather 4 2790		Leather 5 2895		Leather 6 3000		Leather 8 3855		COL 1797		S Nail Std.		M Nail N/A	

Fabric SKU: **6046-A2**

Leather SKU: **L-6046-A2**

Standard Pillows: N/A Finish Req: Y

Standard Cushions: High Resiliency 40 Standard Finish:

COM: 3.25 yards COL: 62 square feet

Gresham Occasional Chair

Width: 28.5 Depth: 24.5 Height: 33

AH: 26 SH: 20 SD: 19 IW: 20

Weight: 25 lbs Cube: 21.65

D	E	F	G	H	J	K COM	L	M	N	O	P	Q	R	S	T	U	(# above U) *	S Nail	M Nail
1761	1770	1779	1788	1797	1806	1815	1824	1833	1842	1851	1860	1869	1878	1887	1896	1905	9 (Riser) + 1905 (U)	45	N/A
Leather 1 2505		Leather 2 2610		Leather 3 2715		Leather 4 2820		Leather 5 2925		Leather 6 3030		Leather 8 3885		COL 1833		S Nail Std.		M Nail N/A	

Fabric SKU: **6046-A4**

Leather SKU: **L-6046-A4**

Standard Pillows: N/A Finish Req: Y

Standard Cushions: High Resiliency 40 Standard Finish:

COM: 3.25 yards COL: 62 square feet

Gresham Occasional Chair

Width: 28.5 Depth: 24.5 Height: 33

AH: 26 SH: 20 SD: 19 IW: 20

Weight: 35 lbs Cube: 21.65

D	E	F	G	H	J	K COM	L	M	N	O	P	Q	R	S	T	U	(# above U) *	S Nail	M Nail
1797	1806	1815	1824	1833	1842	1851	1860	1869	1878	1887	1896	1905	1914	1923	1932	1941	9 (Riser) + 1941 (U)	45	N/A
Leather 1 2550		Leather 2 2655		Leather 3 2760		Leather 4 2865		Leather 5 2970		Leather 6 3075		Leather 8 3930		COL 1869		S Nail Std.		M Nail N/A	

Fabric SKU: **6048-04**

Leather SKU: **N/A**

Standard Pillows: N/A Finish Req: N

Standard Cushions: High Resiliency 40 Standard Finish: Traditional

COM: 7.5 yards COL: N/A

Kathleen Arm Chair

Width: 24.5 Depth: 29.5 Height: 44.5

AH: 24.5 SH: 20 SD: 18 IW: 19

Weight: 40 lbs Cube: 24.14

D	E	F	G	H	J	K COM	L	M	N	O	P	Q	R	S	T	U	(# above U) *	S Nail	M Nail
1800	1824	1848	1872	1896	1920	1944	1968	1992	2016	2040	2064	2088	2112	2136	2160	2184	24 (Riser) + 2184 (U)	45	N/A
Leather 1 N/A		Leather 2 N/A		Leather 3 N/A		Leather 4 N/A		Leather 5 N/A		Leather 6 N/A		Leather 8 N/A		COL N/A		S Nail N/A		M Nail N/A	

Fabric SKU: **6048-05**

Leather SKU: **N/A**

Standard Pillows: N/A Finish Req: N

Standard Cushions: High Resiliency 40 Standard Finish: Traditional

COM: 5.25 yards COL: N/A

Kathleen Side Chair

Width: 21 Depth: 29.5 Height: 44.5

AH: 0 SH: 20 SD: 18 IW: 19

Weight: 30 lbs Cube: 29.34

D	E	F	G	H	J	K COM	L	M	N	O	P	Q	R	S	T	U	(# above U) *	S Nail	M Nail
1680	1704	1728	1752	1776	1800	1824	1848	1872	1896	1920	1944	1968	1992	2016	2040	2064	24 (Riser) + 2064 (U)	45	N/A
Leather 1 N/A		Leather 2 N/A		Leather 3 N/A		Leather 4 N/A		Leather 5 N/A		Leather 6 N/A		Leather 8 N/A		COL N/A		S Nail N/A		M Nail N/A	

Upholstery

**Pillows are not available on leather SKUs*

Fabric SKU: **6049-04**

Leather SKU: **N/A**

Standard Pillows: N/A **Finish Req:** N

Standard Cushions: High Resiliency 40 **Standard Finish:** Traditional

COM: 6.5 yards **COL:** N/A

Standard with contrasting centered stripe application with any fabric.

Kathleen Arm Chair

Width: 24.5 **Depth:** 29.5 **Height:** 44.5

AH: 24.5 **SH:** 20 **SD:** 18 **IW:** 19

Weight: 40 lbs **Cube:** 21.65

D	E	F	G	H	J	K COM	L	M	N	O	P	Q	R	S	T	U	(# above U) *	S Nail	M Nail
1875	1899	1923	1947	1971	1995	2019	2043	2067	2091	2115	2139	2163	2187	2211	2235	2259	24 (Riser) + 2259 (U)	45	N/A
Leather 1 N/A		Leather 2 N/A		Leather 3 N/A		Leather 4 N/A		Leather 5 N/A		Leather 6 N/A		Leather 8 N/A		COL N/A		S Nail N/A		M Nail N/A	

Fabric SKU: **6049-05**

Leather SKU: **N/A**

Standard Pillows: N/A **Finish Req:** N

Standard Cushions: High Resiliency 40 **Standard Finish:** Traditional

COM: 5.25 yards **COL:** N/A

Standard with contrasting centered stripe application with any fabric.

Kathleen Side Chair

Width: 21 **Depth:** 29.5 **Height:** 44.5

AH: 0 **SH:** 20 **SD:** 18 **IW:** 19

Weight: 30 lbs **Cube:** 17.77

D	E	F	G	H	J	K COM	L	M	N	O	P	Q	R	S	T	U	(# above U) *	S Nail	M Nail
1785	1809	1833	1857	1881	1905	1929	1953	1977	2001	2025	2049	2073	2097	2121	2145	2169	24 (Riser) + 2169 (U)	45	N/A
Leather 1 N/A		Leather 2 N/A		Leather 3 N/A		Leather 4 N/A		Leather 5 N/A		Leather 6 N/A		Leather 8 N/A		COL N/A		S Nail N/A		M Nail N/A	

Fabric SKU: **6052-01**

Leather SKU: **L-6052-01**

Standard Pillows: N/A **Finish Req:** Y

Standard Cushions: High Resiliency 30 **Standard Finish:**

COM: 3.25 yards **COL:** 53.1 square feet

Jennings Occasional Chair

Width: 30.5 **Depth:** 29 **Height:** 29.5

AH: 24 **SH:** 17.5 **SD:** 22.5 **IW:** 26

Weight: 25 lbs **Cube:** 23.89

D	E	F	G	H	J	K COM	L	M	N	O	P	Q	R	S	T	U	(# above U) *	S Nail	M Nail
1575	1584	1593	1602	1611	1620	1629	1638	1647	1656	1665	1674	1683	1692	1701	1710	1719	9 (Riser) + 1719 (U)	45	60
Leather 1 2325		Leather 2 2415		Leather 3 2505		Leather 4 2595		Leather 5 2685		Leather 6 2775		Leather 8 3510		COL 1647		S Nail 45		M Nail 60	

Fabric SKU: **6053-01**

Leather SKU: **L-6053-01**

Standard Pillows: N/A **Finish Req:** Y

Standard Cushions: High Resiliency 40 **Standard Finish:**

COM: 3.5 yards **COL:** 68 square feet

Lindale Occasional Chair

Width: 23 **Depth:** 24 **Height:** 37.5

AH: 24.5 **SH:** 21 **SD:** 19 **IW:** 20

Weight: 30 lbs **Cube:** 15.74

D	E	F	G	H	J	K COM	L	M	N	O	P	Q	R	S	T	U	(# above U) *	S Nail	M Nail
1575	1587	1599	1611	1623	1635	1647	1659	1671	1683	1695	1707	1719	1731	1743	1755	1767	12 (Riser) + 1767 (U)	N/A	N/A
Leather 1 2400		Leather 2 2505		Leather 3 2610		Leather 4 2715		Leather 5 2820		Leather 6 2925		Leather 8 3870		COL 1671		S Nail N/A		M Nail N/A	

Fabric SKU: **6062-01**

Leather SKU: **L-6062-01**

Standard Pillows: N/A **Finish Req:** Y

Standard Cushions: High Resiliency 40 **Standard Finish:**

COM: 3.75 yards **COL:** 62 square feet

Lockhart Occasional Chair

Width: 25.5 **Depth:** 26 **Height:** 35.5

AH: 24.5 **SH:** 19 **SD:** 19 **IW:** 19

Weight: 35 lbs **Cube:** 21.65

D	E	F	G	H	J	K COM	L	M	N	O	P	Q	R	S	T	U	(# above U) *	S Nail	M Nail
1545	1557	1569	1581	1593	1605	1617	1629	1641	1653	1665	1677	1689	1701	1713	1725	1737	12 (Riser) + 1737 (U)	45	60
Leather 1 2400		Leather 2 2505		Leather 3 2610		Leather 4 2715		Leather 5 2820		Leather 6 2925		Leather 8 3780		COL 1641		S Nail 45		M Nail 60	

Fabric SKU: **6063-35**

Leather SKU: **L-6063-35**

Standard Pillows: N/A **Finish Req:** Y

Standard Cushions: High Resiliency 40 **Standard Finish:**

COM: 3.5 yards **COL:** 57.6 square feet

Standard with a gas lift.

Jordan Office Swivel Chair

Width: 26 **Depth:** 28 **Height:** 36

AH: 0 **SH:** 0 **SD:** 18 **IW:** 22

Weight: 30 lbs **Cube:** 21.65

D	E	F	G	H	J	K COM	L	M	N	O	P	Q	R	S	T	U	(# above U) *	S Nail	M Nail
1680	1689	1698	1707	1716	1725	1734	1743	1752	1761	1770	1779	1788	1797	1806	1815	1824	9 (Riser) + 1824 (U)	45	60
Leather 1 2430		Leather 2 2520		Leather 3 2610		Leather 4 2700		Leather 5 2790		Leather 6 2880		Leather 8 3675		COL 1752		S Nail 45		M Nail 60	

Upholstery

**Pillows are not available on leather SKUs*

Fabric SKU: **6064-01**

Leather SKU: **L-6064-01**

Standard Pillows: N/A Finish Req: Y

Standard Cushions: High Resiliency 30 Standard Finish:

COM: 4 yards COL: 63.75 square feet

Laurens Occasional Chair

Width: 25.5 Depth: 28.5 Height: 41

AH: 27.5 SH: 20 SD: 19 IW: 19

Weight: 40 lbs Cube: 21.65

D	E	F	G	H	J	K COM	L	M	N	O	P	Q	R	S	T	U	(# above U) *	S Nail	M Nail
1605	1617	1629	1641	1653	1665	1677	1689	1701	1713	1725	1737	1749	1761	1773	1785	1797	12 (Riser) + 1797 (U)	45	60
Leather 1 2490		Leather 2 2595		Leather 3 2700		Leather 4 2805		Leather 5 2910		Leather 6 3015		Leather 8 3900		COL 1701		S Nail 45		M Nail 60	

Fabric SKU: **6068-04**

Leather SKU: **L-6068-04**

Standard Pillows: N/A Finish Req: Y

Standard Cushions: High Resiliency 40 Standard Finish:

COM: 2 yards COL: 40 square feet

Keller Arm Chair

Width: 23.5 Depth: 24 Height: 31.5

AH: 24.5 SH: 19.5 SD: 20.5 IW: 20

Weight: 30 lbs Cube: 15.74

D	E	F	G	H	J	K COM	L	M	N	O	P	Q	R	S	T	U	(# above U) *	S Nail	M Nail
1125	1131	1137	1143	1149	1155	1161	1167	1173	1179	1185	1191	1197	1203	1209	1215	1221	6 (Riser) + 1221 (U)	45	N/A
Leather 1 1545		Leather 2 1605		Leather 3 1665		Leather 4 1725		Leather 5 1785		Leather 6 1845		Leather 8 2400		COL 1173		S Nail 45		M Nail N/A	

Fabric SKU: **6068-A4**

Leather SKU: **L-6068-A4**

Standard Pillows: N/A Finish Req: Y

Standard Cushions: High Resiliency 40 Standard Finish:

COM: 2 yards COL: 40 square feet

Keller Arm Chair

Width: 23.5 Depth: 24 Height: 31.5

AH: 24.5 SH: 19.5 SD: 20.5 IW: 20

Weight: 30 lbs Cube: 15.74

D	E	F	G	H	J	K COM	L	M	N	O	P	Q	R	S	T	U	(# above U) *	S Nail	M Nail
1197	1203	1209	1215	1221	1227	1233	1239	1245	1251	1257	1263	1269	1275	1281	1287	1293	6 (Riser) + 1293 (U)	45	N/A
Leather 1 1620		Leather 2 1680		Leather 3 1740		Leather 4 1800		Leather 5 1860		Leather 6 1920		Leather 8 2475		COL 1245		S Nail 45		M Nail N/A	

Fabric SKU: **6069-04**

Leather SKU: **L-6069-04**

Standard Pillows: N/A Finish Req: Y

Standard Cushions: High Resiliency 40 Standard Finish:

COM: 3.5 yards COL: 58 square feet

Casey Arm Chair

Width: 25 Depth: 25.5 Height: 38

AH: 26 SH: 20 SD: 17.5 IW: 22

Weight: 30 lbs Cube: 15.74

D	E	F	G	H	J	K COM	L	M	N	O	P	Q	R	S	T	U	(# above U) *	S Nail	M Nail
1125	1134	1143	1152	1161	1170	1179	1188	1197	1206	1215	1224	1233	1242	1251	1260	1269	9 (Riser) + 1269 (U)	45	60
Leather 1 1740		Leather 2 1830		Leather 3 1920		Leather 4 2010		Leather 5 2100		Leather 6 2190		Leather 8 2985		COL 1197		S Nail 45		M Nail 60	

Fabric SKU: **6069-05**

Leather SKU: **L-6069-05**

Standard Pillows: N/A Finish Req: Y

Standard Cushions: High Resiliency 40 Standard Finish:

COM: 3.5 yards COL: 58 square feet

Casey Side Chair

Width: 22.5 Depth: 25.5 Height: 38

AH: 0 SH: 20 SD: 17.5 IW: 0

Weight: 25 lbs Cube: 15.74

D	E	F	G	H	J	K COM	L	M	N	O	P	Q	R	S	T	U	(# above U) *	S Nail	M Nail
1080	1089	1098	1107	1116	1125	1134	1143	1152	1161	1170	1179	1188	1197	1206	1215	1224	9 (Riser) + 1224 (U)	45	60
Leather 1 1710		Leather 2 1800		Leather 3 1890		Leather 4 1980		Leather 5 2070		Leather 6 2160		Leather 8 2955		COL 1152		S Nail 45		M Nail 60	

Fabric SKU: **6079-01**

Leather SKU: **L-6079-01**

Standard Pillows: N/A Finish Req: Y

Standard Cushions: High Resiliency 40 Standard Finish:

COM: 3.5 yards COL: 57 square feet

Brent Occasional Chair

Width: 27 Depth: 27 Height: 31.5

AH: 26.5 SH: 18.5 SD: 18.5 IW: 19.5

Weight: 35 lbs Cube: 21.65

D	E	F	G	H	J	K COM	L	M	N	O	P	Q	R	S	T	U	(# above U) *	S Nail	M Nail
1620	1629	1638	1647	1656	1665	1674	1683	1692	1701	1710	1719	1728	1737	1746	1755	1764	9 (Riser) + 1764 (U)	60	75
Leather 1 2520		Leather 2 2610		Leather 3 2700		Leather 4 2790		Leather 5 2880		Leather 6 2970		Leather 8 3765		COL 1692		S Nail 60		M Nail 75	

Upholstery

**Pillows are not available on leather SKUs*

Fabric SKU: **6079-A4**

Leather SKU: **L-6079-A4**

Standard Pillows: N/A Finish Req: Y

Standard Cushions: High Resiliency 40 Standard Finish:

COM: 3.5 yards COL: 57 square feet

Brent Occasional Chair

Width: 27 Depth: 27 Height: 31.5

AH: 26.5 SH: 18.5 SD: 18.5 IW: 19.5

Weight: 35 lbs Cube: 21.65

D	E	F	G	H	J	K COM	L	M	N	O	P	Q	R	S	T	U	(# above U) *	S Nail	M Nail
1692	1701	1710	1719	1728	1737	1746	1755	1764	1773	1782	1791	1800	1809	1818	1827	1836	9 (Riser) + 1836 (U)	60	75
Leather 1 2610		Leather 2 2700		Leather 3 2790		Leather 4 2880		Leather 5 2970		Leather 6 3060		Leather 8 3855		COL 1764		S Nail 60		M Nail 75	

Fabric SKU: **6080-01**

Leather SKU: **L-6080-01**

Standard Pillows: N/A Finish Req: Y

Standard Cushions: High Resiliency 40 Standard Finish:

COM: 3.25 yards COL: 51 square feet

Danbury Occasional Chair

Width: 26 Depth: 25 Height: 33.5

AH: 26 SH: 19.5 SD: 20 IW: 21.5

Weight: 50 lbs Cube: 21.65

D	E	F	G	H	J	K COM	L	M	N	O	P	Q	R	S	T	U	(# above U) *	S Nail	M Nail
1530	1539	1548	1557	1566	1575	1584	1593	1602	1611	1620	1629	1638	1647	1656	1665	1674	9 (Riser) + 1674 (U)	Std.	N/A
Leather 1 2235		Leather 2 2310		Leather 3 2385		Leather 4 2460		Leather 5 2535		Leather 6 2610		Leather 8 3315		COL 1602		S Nail Std.		M Nail N/A	

Fabric SKU: **6080-A2**

Leather SKU: **L-6080-A2**

Standard Pillows: N/A Finish Req: Y

Standard Cushions: High Resiliency 40 Standard Finish:

COM: 3.25 yards COL: 53.1 square feet

Danbury Barrel Occasional Chair

Width: 26 Depth: 25 Height: 33

AH: 26 SH: 19.5 SD: 20 IW: 21.5

Weight: 50 lbs Cube: 21.65

D	E	F	G	H	J	K COM	L	M	N	O	P	Q	R	S	T	U	(# above U) *	S Nail	M Nail
1566	1575	1584	1593	1602	1611	1620	1629	1638	1647	1656	1665	1674	1683	1692	1701	1710	9 (Riser) + 1710 (U)	Std.	N/A
Leather 1 2265		Leather 2 2355		Leather 3 2445		Leather 4 2535		Leather 5 2625		Leather 6 2715		Leather 8 3450		COL 1638		S Nail Std.		M Nail N/A	

Fabric SKU: **6080-A4**

Leather SKU: **L-6080-A4**

Standard Pillows: N/A Finish Req: Y

Standard Cushions: High Resiliency 40 Standard Finish:

COM: 3.25 yards COL: 53.1 square feet

Danbury Occasional Chair

Width: 26 Depth: 25 Height: 33

AH: 26 SH: 19.5 SD: 20 IW: 21.5

Weight: 50 lbs Cube: 21.65

D	E	F	G	H	J	K COM	L	M	N	O	P	Q	R	S	T	U	(# above U) *	S Nail	M Nail
1602	1611	1620	1629	1638	1647	1656	1665	1674	1683	1692	1701	1710	1719	1728	1737	1746	9 (Riser) + 1746 (U)	Std.	N/A
Leather 1 2310		Leather 2 2400		Leather 3 2490		Leather 4 2580		Leather 5 2670		Leather 6 2760		Leather 8 3495		COL 1674		S Nail Std.		M Nail N/A	

Fabric SKU: **6082-01**

Leather SKU: **L-6082-01**

Standard Pillows: N/A Finish Req: Y

Standard Cushions: Ultra Plush Standard Finish:

COM: 4.75 yards COL: 91 square feet

Jamie Lounge Chair

Width: 32 Depth: 30.5 Height: 32

AH: 23.5 SH: 20.5 SD: 24 IW: 22

Weight: 54 lbs Cube: 29.69

D	E	F	G	H	J	K COM	L	M	N	O	P	Q	R	S	T	U	(# above U) *	S Nail	M Nail
2325	2340	2355	2370	2385	2400	2415	2430	2445	2460	2475	2490	2505	2520	2535	2550	2565	15 (Riser) + 2565 (U)	N/A	N/A
Leather 1 3555		Leather 2 3690		Leather 3 3825		Leather 4 3960		Leather 5 4095		Leather 6 4230		Leather 8 5490		COL 2445		S Nail N/A		M Nail N/A	

Fabric SKU: **6082-MS-2**

Leather SKU: **L-6082-MS-2**

Standard Pillows: N/A Finish Req: N

Standard Cushions: Ultra Plush Standard Finish: Nickel

COM: 4.75 yards COL: 91 square feet

Only available in Nickel finish

Jamie Memory Swivel Chair

Width: 32 Depth: 30.5 Height: 32

AH: 23.5 SH: 20.5 SD: 24 IW: 22

Weight: 54 lbs Cube: 23.89

D	E	F	G	H	J	K COM	L	M	N	O	P	Q	R	S	T	U	(# above U) *	S Nail	M Nail
2625	2640	2655	2670	2685	2700	2715	2730	2745	2760	2775	2790	2805	2820	2835	2850	2865	15 (Riser) + 2865 (U)	N/A	N/A
Leather 1 3810		Leather 2 3945		Leather 3 4080		Leather 4 4215		Leather 5 4350		Leather 6 4485		Leather 8 5745		COL 2745		S Nail N/A		M Nail N/A	

Upholstery

**Pillows are not available on leather SKUs*

Fabric SKU: **6082-MS-6**

Leather SKU: **L-6082-MS-6**

Standard Pillows: N/A **Finish Req:** N

Standard Cushions: Ultra Plush **Standard Finish:** Brushed Brass

COM: 4.75 yards **COL:** 91 square feet

Only available in Brushed Brass finish

Jamie Memory Swivel Chair

Width: 32 **Depth:** 30.5 **Height:** 32

AH: 23.5 **SH:** 20.5 **SD:** 24 **IW:** 22

Weight: 54 lbs **Cube:** 23.89

D	E	F	G	H	J	K COM	L	M	N	O	P	Q	R	S	T	U	(# above U) *	S Nail	M Nail
2625	2640	2655	2670	2685	2700	2715	2730	2745	2760	2775	2790	2805	2820	2835	2850	2865	15 (Riser) + 2865 (U)	N/A	N/A
Leather 1 3810		Leather 2 3945		Leather 3 4080		Leather 4 4215		Leather 5 4350		Leather 6 4485		Leather 8 5745		COL 2745		S Nail N/A		M Nail N/A	

Fabric SKU: **6085-01**

Leather SKU: **L-6085-01**

Standard Pillows: N/A **Finish Req:** Y

Standard Cushions: High Resiliency 40 **Standard Finish:**

COM: 3.75 yards **COL:** 62 square feet

Devin Lounge Chair

Width: 29.5 **Depth:** 33 **Height:** 35.5

AH: 24 **SH:** 19 **SD:** 21 **IW:** 20

Weight: 43 lbs **Cube:** 29.69

D	E	F	G	H	J	K COM	L	M	N	O	P	Q	R	S	T	U	(# above U) *	S Nail	M Nail
2100	2112	2124	2136	2148	2160	2172	2184	2196	2208	2220	2232	2244	2256	2268	2280	2292	12 (Riser) + 2292 (U)	N/A	N/A
Leather 1 2895		Leather 2 3000		Leather 3 3105		Leather 4 3210		Leather 5 3315		Leather 6 3420		Leather 8 4275		COL 2196		S Nail N/A		M Nail N/A	

Fabric SKU: **6085-1N**

Leather SKU: **L-6085-1N**

Standard Pillows: N/A **Finish Req:** N

Standard Cushions: High Resiliency 40 **Standard Finish:** Nickel

COM: 3.75 yards **COL:** 63 square feet

Features Swivel Nickel Base with Casters

Devin Task Chair

Width: 26.5 **Depth:** 31 **Height:** 36.25

AH: 25.25 **SH:** 20 **SD:** 22 **IW:** 20

Weight: 39 lbs **Cube:** 23.89

D	E	F	G	H	J	K COM	L	M	N	O	P	Q	R	S	T	U	(# above U) *	S Nail	M Nail
1980	1992	2004	2016	2028	2040	2052	2064	2076	2088	2100	2112	2124	2136	2148	2160	2172	12 (Riser) + 2172 (U)	N/A	N/A
Leather 1 2895		Leather 2 3000		Leather 3 3105		Leather 4 3210		Leather 5 3315		Leather 6 3420		Leather 8 4290		COL 2076		S Nail N/A		M Nail N/A	

Fabric SKU: **6085-2N**

Leather SKU: **L-6085-2N**

Standard Pillows: N/A **Finish Req:** N

Standard Cushions: High Resiliency 40 **Standard Finish:** Nickel

COM: 3.75 yards **COL:** 63 square feet

Features Stationary Nickel Plated Base with a gas cylinder.

Devin Swivel Chair

Width: 26.5 **Depth:** 31 **Height:** 34.75

AH: 23.75 **SH:** 18.5 **SD:** 22 **IW:** 20

Weight: 39 lbs **Cube:** 23.89

D	E	F	G	H	J	K COM	L	M	N	O	P	Q	R	S	T	U	(# above U) *	S Nail	M Nail
1980	1992	2004	2016	2028	2040	2052	2064	2076	2088	2100	2112	2124	2136	2148	2160	2172	12 (Riser) + 2172 (U)	N/A	N/A
Leather 1 2895		Leather 2 3000		Leather 3 3105		Leather 4 3210		Leather 5 3315		Leather 6 3420		Leather 8 4290		COL 2076		S Nail N/A		M Nail N/A	

Fabric SKU: **6086-04**

Leather SKU: **N/A**

Standard Pillows: N/A **Finish Req:** Y

Standard Cushions: High Resiliency 40 **Standard Finish:**

COM: 6.5 yards **COL:** N/A

Reed Arm Chair

Width: 24.5 **Depth:** 29 **Height:** 44

AH: 24 **SH:** 21 **SD:** 18.5 **IW:** 19

Weight: 41 lbs **Cube:** 27.3

D	E	F	G	H	J	K COM	L	M	N	O	P	Q	R	S	T	U	(# above U) *	S Nail	M Nail
1785	1803	1821	1839	1857	1875	1893	1911	1929	1947	1965	1983	2001	2019	2037	2055	2073	18 (Riser) + 2073 (U)	45	N/A
Leather 1 N/A		Leather 2 N/A		Leather 3 N/A		Leather 4 N/A		Leather 5 N/A		Leather 6 N/A		Leather 8 N/A		COL N/A		S Nail N/A		M Nail N/A	

Fabric SKU: **6086-05**

Leather SKU: **N/A**

Standard Pillows: N/A **Finish Req:** Y

Standard Cushions: High Resiliency 40 **Standard Finish:**

COM: 4.75 yards **COL:** N/A

Reed Side Chair

Width: 21 **Depth:** 29 **Height:** 44

AH: 0 **SH:** 21 **SD:** 18.5 **IW:** 0

Weight: 31 lbs **Cube:** 21.65

D	E	F	G	H	J	K COM	L	M	N	O	P	Q	R	S	T	U	(# above U) *	S Nail	M Nail
1680	1695	1710	1725	1740	1755	1770	1785	1800	1815	1830	1845	1860	1875	1890	1905	1920	15 (Riser) + 1920 (U)	45	N/A
Leather 1 N/A		Leather 2 N/A		Leather 3 N/A		Leather 4 N/A		Leather 5 N/A		Leather 6 N/A		Leather 8 N/A		COL N/A		S Nail N/A		M Nail N/A	

Upholstery

**Pillows are not available on leather SKUs*

Fabric SKU: **6087-01**

Leather SKU: **N/A**

Standard Pillows: N/A Finish Req: Y

Standard Cushions: High Resiliency 40 Standard Finish:

COM: 4.75 yards COL: N/A

Nina Lounge Chair

Width: 29.25 Depth: 29.25 Height: 34.25

AH: 24.75 SH: 19.75 SD: 20.5 IW: 22.5

Weight: 40 lbs Cube: 16.95

D	E	F	G	H	J	K COM	L	M	N	O	P	Q	R	S	T	U	(# above U) *	S Nail	M Nail
2175	2190	2205	2220	2235	2250	2265	2280	2295	2310	2325	2340	2355	2370	2385	2400	2415	15 (Riser) + 2415 (U)	90	N/A
Leather 1 N/A		Leather 2 N/A		Leather 3 N/A		Leather 4 N/A		Leather 5 N/A		Leather 6 N/A		Leather 8 N/A		COL N/A		S Nail N/A		M Nail N/A	

Fabric SKU: **6088-01**

Leather SKU: **L-6088-01**

Standard Pillows: N/A Finish Req: Y

Standard Cushions: High Resiliency 35 Standard Finish:

COM: 3.25 yards COL: 62 square feet

Lynnhaven Occasional Chair

Width: 26.5 Depth: 29.5 Height: 32.5

AH: 22 SH: 19 SD: 22 IW: 21

Weight: 29 lbs Cube: 21.65

D	E	F	G	H	J	K COM	L	M	N	O	P	Q	R	S	T	U	(# above U) *	S Nail	M Nail
2070	2082	2094	2106	2118	2130	2142	2154	2166	2178	2190	2202	2214	2226	2238	2250	2262	12 (Riser) + 2262 (U)	N/A	N/A
Leather 1 2640		Leather 2 2745		Leather 3 2850		Leather 4 2955		Leather 5 3060		Leather 6 3165		Leather 8 4020		COL 2166		S Nail N/A		M Nail N/A	

Fabric SKU: **6090-01**

Leather SKU: **L-6090-01**

Standard Pillows: N/A Finish Req: Y

Standard Cushions: High Resiliency 50 Standard Finish:

COM: 3.5 yards COL: 68 square feet

Features a clean out back detail.

Lana Occasional Chair

Width: 28.5 Depth: 24.5 Height: 30.5

AH: 23 SH: 18.5 SD: 22 IW: 21

Weight: 37 lbs Cube: 12.32

D	E	F	G	H	J	K COM	L	M	N	O	P	Q	R	S	T	U	(# above U) *	S Nail	M Nail
1875	1887	1899	1911	1923	1935	1947	1959	1971	1983	1995	2007	2019	2031	2043	2055	2067	12 (Riser) + 2067 (U)	90	N/A
Leather 1 2685		Leather 2 2790		Leather 3 2895		Leather 4 3000		Leather 5 3105		Leather 6 3210		Leather 8 4155		COL 1971		S Nail 90		M Nail N/A	

Fabric SKU: **6092-01**

Leather SKU: **L-6092-01**

Standard Pillows: N/A Finish Req: Y

Standard Cushions: High Resiliency 40 Standard Finish:

COM: 3.75 yards COL: 68 square feet

Fiona Occasional Chair

Width: 25 Depth: 28.25 Height: 34.5

AH: 24 SH: 19.25 SD: 19 IW: 18.5

Weight: 51 lbs Cube: 23.89

D	E	F	G	H	J	K COM	L	M	N	O	P	Q	R	S	T	U	(# above U) *	S Nail	M Nail
1914	1926	1938	1950	1962	1974	1986	1998	2010	2022	2034	2046	2058	2070	2082	2094	2106	12 (Riser) + 2106 (U)	90	105
Leather 1 2895		Leather 2 3000		Leather 3 3105		Leather 4 3210		Leather 5 3315		Leather 6 3420		Leather 8 4365		COL 2010		S Nail 90		M Nail 105	

Fabric SKU: **6092-A2**

Leather SKU: **L-6092-A2**

Standard Pillows: N/A Finish Req: Y

Standard Cushions: High Resiliency 40 Standard Finish:

COM: 3.75 yards COL: 68 square feet

Fiona Occasional Chair

Width: 25 Depth: 28.25 Height: 34.5

AH: 24 SH: 19.25 SD: 19 IW: 18.5

Weight: 51 lbs Cube: 14.1

D	E	F	G	H	J	K COM	L	M	N	O	P	Q	R	S	T	U	(# above U) *	S Nail	M Nail
1950	1962	1974	1986	1998	2010	2022	2034	2046	2058	2070	2082	2094	2106	2118	2130	2142	12 (Riser) + 2142 (U)	90	105
Leather 1 2925		Leather 2 3030		Leather 3 3135		Leather 4 3240		Leather 5 3345		Leather 6 3450		Leather 8 4395		COL 2046		S Nail 90		M Nail 105	

Fabric SKU: **6092-A4**

Leather SKU: **L-6092-A4**

Standard Pillows: N/A Finish Req: Y

Standard Cushions: High Resiliency 40 Standard Finish:

COM: 3.75 yards COL: 68 square feet

Fiona Occasional Chair

Width: 25 Depth: 28.25 Height: 34.5

AH: 24 SH: 19.25 SD: 19 IW: 18.5

Weight: 51 lbs Cube: 21.65

D	E	F	G	H	J	K COM	L	M	N	O	P	Q	R	S	T	U	(# above U) *	S Nail	M Nail
1986	1998	2010	2022	2034	2046	2058	2070	2082	2094	2106	2118	2130	2142	2154	2166	2178	12 (Riser) + 2178 (U)	90	105
Leather 1 2970		Leather 2 3075		Leather 3 3180		Leather 4 3285		Leather 5 3390		Leather 6 3495		Leather 8 4440		COL 2082		S Nail 90		M Nail 105	

Upholstery

**Pillows are not available on leather SKUs*

Fabric SKU: **6096-01**

Leather SKU: **N/A**

Standard Pillows: N/A **Finish Req:** Y

Standard Cushions: High Resiliency 30 **Standard Finish:**

COM: 4.75 yards **COL:** N/A

Callie Occasional Chair

Width: 26.5 **Depth:** 31.5 **Height:** 35

AH: 25 **SH:** 20 **SD:** 22 **IW:** 20

Weight: 43 lbs **Cube:** 23.89

D	E	F	G	H	J	K COM	L	M	N	O	P	Q	R	S	T	U	(# above U) *	S Nail	M Nail
2100	2115	2130	2145	2160	2175	2190	2205	2220	2235	2250	2265	2280	2295	2310	2325	2340	15 (Riser) + 2340 (U)	75	N/A
Leather 1 N/A		Leather 2 N/A		Leather 3 N/A		Leather 4 N/A		Leather 5 N/A		Leather 6 N/A		Leather 8 N/A		COL N/A		S Nail N/A		M Nail N/A	

Fabric SKU: **6100-04**

Leather SKU: **L-6100-04**

Standard Pillows: N/A **Finish Req:** Y

Standard Cushions: High Resiliency 40 **Standard Finish:**

COM: 2 yards **COL:** 29 square feet

Features natural cane accents that was handwoven using the peel of natural rattan. As with any natural product, natures imperfections and hallmarks will be present in the cane materials. Cane is a handcrafted product dating back to the Ancient Egyptians.

Harlow Arm Chair

Width: 23 **Depth:** 24 **Height:** 36.5

AH: 24 **SH:** 19.5 **SD:** 19 **IW:** 20

Weight: 21 lbs **Cube:** 11.65

D	E	F	G	H	J	K COM	L	M	N	O	P	Q	R	S	T	U	(# above U) *	S Nail	M Nail
1125	1131	1137	1143	1149	1155	1161	1167	1173	1179	1185	1191	1197	1203	1209	1215	1221	6 (Riser) + 1221 (U)	N/A	N/A
Leather 1 1455		Leather 2 1500		Leather 3 1545		Leather 4 1590		Leather 5 1635		Leather 6 1680		Leather 8 2085		COL 1173		S Nail N/A		M Nail N/A	

Fabric SKU: **6100-05**

Leather SKU: **L-6100-05**

Standard Pillows: N/A **Finish Req:** Y

Standard Cushions: High Resiliency 40 **Standard Finish:**

COM: 2 yards **COL:** 29 square feet

Features natural cane accents that was handwoven using the peel of natural rattan. As with any natural product, natures imperfections and hallmarks will be present in the cane materials. Cane is a handcrafted product with artisanal origins dating back to the Ancient Egyptians.

Harlow Side Chair

Width: 20 **Depth:** 24 **Height:** 35.25

AH: 0 **SH:** 19.5 **SD:** 19 **IW:** 20

Weight: 16 lbs **Cube:** 9.79

D	E	F	G	H	J	K COM	L	M	N	O	P	Q	R	S	T	U	(# above U) *	S Nail	M Nail
1095	1101	1107	1113	1119	1125	1131	1137	1143	1149	1155	1161	1167	1173	1179	1185	1191	6 (Riser) + 1191 (U)	N/A	N/A
Leather 1 1425		Leather 2 1470		Leather 3 1515		Leather 4 1560		Leather 5 1605		Leather 6 1650		Leather 8 2055		COL 1143		S Nail N/A		M Nail N/A	

Fabric SKU: **6100-07**

Leather SKU: **L-6100-07**

Standard Pillows: N/A **Finish Req:** Y

Standard Cushions: High Resiliency 40 **Standard Finish:**

COM: 2 yards **COL:** 29 square feet

Features natural cane accents that was handwoven using the peel of natural rattan. As with any natural product, natures imperfections and hallmarks will be present in the cane materials. Cane is a handcrafted product with artisanal origins dating back to the Ancient Egyptians.

Harlow Bar Stool

Width: 19.5 **Depth:** 23.5 **Height:** 44.75

AH: 0 **SH:** 30.5 **SD:** 19 **IW:** 19.5

Weight: 30 lbs **Cube:** 11.86

D	E	F	G	H	J	K COM	L	M	N	O	P	Q	R	S	T	U	(# above U) *	S Nail	M Nail
1170	1176	1182	1188	1194	1200	1206	1212	1218	1224	1230	1236	1242	1248	1254	1260	1266	6 (Riser) + 1266 (U)	N/A	N/A
Leather 1 1500		Leather 2 1545		Leather 3 1590		Leather 4 1635		Leather 5 1680		Leather 6 1725		Leather 8 2130		COL 1218		S Nail N/A		M Nail N/A	

Fabric SKU: **6100-A2**

Leather SKU: **N/A**

Standard Pillows: N/A **Finish Req:** Y

Standard Cushions: High Resiliency 40 **Standard Finish:**

COM: 2 yards **COL:** N/A

Features natural cane accents that are handwoven using the peel of natural rattan. As with any natural product, natures imperfections and hallmarks will be present in the cane materials. Cane is a handcrafted product dating back to the Ancient Egyptians.

Harlow Arm Chair

Two Casters

Width: 23 **Depth:** 24 **Height:** 36.5

AH: 24 **SH:** 19.5 **SD:** 19 **IW:** 20

Weight: 21 lbs **Cube:** 11.65

D	E	F	G	H	J	K COM	L	M	N	O	P	Q	R	S	T	U	(# above U) *	S Nail	M Nail
1161	1167	1173	1179	1185	1191	1197	1203	1209	1215	1221	1227	1233	1239	1245	1251	1257	6 (Riser) + 1257 (U)	N/A	N/A
Leather 1 N/A		Leather 2 N/A		Leather 3 N/A		Leather 4 N/A		Leather 5 N/A		Leather 6 N/A		Leather 8 N/A		COL N/A		S Nail N/A		M Nail N/A	

Fabric SKU: **6100-C7**

Leather SKU: **L-6100-C7**

Standard Pillows: N/A **Finish Req:** Y

Standard Cushions: High Resiliency 40 **Standard Finish:**

COM: 2 yards **COL:** 29 square feet

Features natural cane accents that was handwoven using the peel of natural rattan. As with any natural product, natures imperfections and hallmarks will be present in the cane materials. Cane is a handcrafted product dating back to the Ancient Egyptians.

Harlow Counter Stool

Width: 19.5 **Depth:** 23.5 **Height:** 38.75

AH: 0 **SH:** 24.5 **SD:** 19 **IW:** 19.5

Weight: 30 lbs **Cube:** 10.27

D	E	F	G	H	J	K COM	L	M	N	O	P	Q	R	S	T	U	(# above U) *	S Nail	M Nail
1170	1176	1182	1188	1194	1200	1206	1212	1218	1224	1230	1236	1242	1248	1254	1260	1266	6 (Riser) + 1266 (U)	N/A	N/A
Leather 1 1500		Leather 2 1545		Leather 3 1590		Leather 4 1635		Leather 5 1680		Leather 6 1725		Leather 8 2130		COL 1218		S Nail N/A		M Nail N/A	

Upholstery

**Pillows are not available on leather SKUs*

Fabric SKU: **6101-31**

Leather SKU: **L-6101-31**

Standard Pillows: N/A Finish Req: N

Standard Cushions: Ultra Plush Standard Finish:

COM: 7.25 yards COL: 85 square feet

Barry Swivel Chair

Width: 33.5 Depth: 34.5 Height: 35

AH: 27 SH: 20.5 SD: 22 IW: 21

Weight: 60 lbs Cube: 29.69

D	E	F	G	H	J	K COM	L	M	N	O	P	Q	R	S	T	U	(# above U) *	S Nail	M Nail
2025	2049	2073	2097	2121	2145	2169	2193	2217	2241	2265	2289	2313	2337	2361	2385	2409	24 (Riser) + 2409 (U)	N/A	N/A
Leather 1 3300		Leather 2 3435		Leather 3 3570		Leather 4 3705		Leather 5 3840		Leather 6 3975		Leather 8 5145		COL 2217		S Nail N/A		M Nail N/A	

Fabric SKU: **6101-32**

Leather SKU: **L-6101-32**

Standard Pillows: N/A Finish Req: N

Standard Cushions: Ultra Plush Standard Finish:

COM: 7.25 yards COL: 85 square feet

Barry Swivel Glider

Width: 33.5 Depth: 34.5 Height: 35

AH: 27 SH: 20.5 SD: 22 IW: 21

Weight: 75 lbs Cube: 29.29

D	E	F	G	H	J	K COM	L	M	N	O	P	Q	R	S	T	U	(# above U) *	S Nail	M Nail
2175	2199	2223	2247	2271	2295	2319	2343	2367	2391	2415	2439	2463	2487	2511	2535	2559	24 (Riser) + 2559 (U)	N/A	N/A
Leather 1 3450		Leather 2 3585		Leather 3 3720		Leather 4 3855		Leather 5 3990		Leather 6 4125		Leather 8 5295		COL 2367		S Nail N/A		M Nail N/A	

Fabric SKU: **6102-05-2**

Leather SKU: **L-6102-05-2**

Standard Pillows: N/A Finish Req: N

Standard Cushions: High Resiliency 40 Standard Finish: Nickel

COM: 2 yards COL: 40 square feet

Coley Side Chair

Nickel Finish

Width: 19 Depth: 23.5 Height: 31

AH: 0 SH: 19.25 SD: 19.5 IW: 19

Weight: 21 lbs Cube: 8.01

D	E	F	G	H	J	K COM	L	M	N	O	P	Q	R	S	T	U	(# above U) *	S Nail	M Nail
1050	1056	1062	1068	1074	1080	1086	1092	1098	1104	1110	1116	1122	1128	1134	1140	1146	6 (Riser) + 1146 (U)	N/A	N/A
Leather 1 1500		Leather 2 1560		Leather 3 1620		Leather 4 1680		Leather 5 1740		Leather 6 1800		Leather 8 2355		COL 1098		S Nail N/A		M Nail N/A	

Fabric SKU: **6102-05-6**

Leather SKU: **L-6102-05-6**

Standard Pillows: N/A Finish Req: N

Standard Cushions: High Resiliency 40 Standard Finish: Brushed Brass

COM: 2 yards COL: 40 square feet

Coley Side Chair

Brushed Brass Finish

Width: 19 Depth: 23 Height: 31

AH: 0 SH: 19.25 SD: 19.5 IW: 19

Weight: 21 lbs Cube: 7.83

D	E	F	G	H	J	K COM	L	M	N	O	P	Q	R	S	T	U	(# above U) *	S Nail	M Nail
1050	1056	1062	1068	1074	1080	1086	1092	1098	1104	1110	1116	1122	1128	1134	1140	1146	6 (Riser) + 1146 (U)	N/A	N/A
Leather 1 1500		Leather 2 1560		Leather 3 1620		Leather 4 1680		Leather 5 1740		Leather 6 1800		Leather 8 2355		COL 1098		S Nail N/A		M Nail N/A	

Fabric SKU: **6102-C7-2**

Leather SKU: **L-6102-C7-2**

Standard Pillows: N/A Finish Req: N

Standard Cushions: High Resiliency 40 Standard Finish: Nickel

COM: 2 yards COL: 40 square feet

Coley Counter Stool

Nickel Finish

Width: 18.25 Depth: 21.25 Height: 37.25

AH: 0 SH: 25 SD: 17.75 IW: 17.75

Weight: 24 lbs Cube: 8.35

D	E	F	G	H	J	K COM	L	M	N	O	P	Q	R	S	T	U	(# above U) *	S Nail	M Nail
1245	1251	1257	1263	1269	1275	1281	1287	1293	1299	1305	1311	1317	1323	1329	1335	1341	6 (Riser) + 1341 (U)	N/A	N/A
Leather 1 1740		Leather 2 1800		Leather 3 1860		Leather 4 1920		Leather 5 1980		Leather 6 2040		Leather 8 2595		COL 1293		S Nail N/A		M Nail N/A	

Fabric SKU: **6102-C7-6**

Leather SKU: **L-6102-C7-6**

Standard Pillows: N/A Finish Req: N

Standard Cushions: High Resiliency 40 Standard Finish: Brushed Brass

COM: 2 yards COL: 40 square feet

Coley Counter Stool

Brushed Brass Finish

Width: 18.25 Depth: 21.25 Height: 37.25

AH: 0 SH: 25 SD: 17.75 IW: 17.75

Weight: 24 lbs Cube: 8.35

D	E	F	G	H	J	K COM	L	M	N	O	P	Q	R	S	T	U	(# above U) *	S Nail	M Nail
1245	1251	1257	1263	1269	1275	1281	1287	1293	1299	1305	1311	1317	1323	1329	1335	1341	6 (Riser) + 1341 (U)	N/A	N/A
Leather 1 1740		Leather 2 1800		Leather 3 1860		Leather 4 1920		Leather 5 1980		Leather 6 2040		Leather 8 2595		COL 1293		S Nail N/A		M Nail N/A	

Upholstery

**Pillows are not available on leather SKUs*

Fabric SKU: **6103-31**

Leather SKU: **N/A**

Standard Pillows: N/A **Finish Req:** N

Standard Cushions: Classic Plush **Standard Finish:**

COM: 6.75 yards **COL:** N/A

Features a clean out design.

Sunset Swivel Chair

Width: 30.75 **Depth:** 32.5 **Height:** 34.5

AH: 24.75 **SH:** 18.75 **SD:** 23 **IW:** 22

Weight: 65 lbs **Cube:** 19.95

D 2325	E 2346	F 2367	G 2388	H 2409	J 2430	K COM 2451	L 2472	M 2493	N 2514	O 2535	P 2556	Q 2577	R 2598	S 2619	T 2640	U 2661	(# above U) * 21 (Riser) + 2661 (U)	S Nail 45	M Nail N/A
Leather 1 N/A		Leather 2 N/A		Leather 3 N/A		Leather 4 N/A		Leather 5 N/A		Leather 6 N/A		Leather 8 N/A		COL N/A		S Nail N/A		M Nail N/A	

Fabric SKU: **6103-32**

Leather SKU: **N/A**

Standard Pillows: N/A **Finish Req:** N

Standard Cushions: Classic Plush **Standard Finish:**

COM: 6.75 yards **COL:** N/A

Features a clean out design.

Sunset Swivel Glider

Width: 30.75 **Depth:** 32.5 **Height:** 34.5

AH: 24.75 **SH:** 18.75 **SD:** 23 **IW:** 22

Weight: 65 lbs **Cube:** 19.95

D 2475	E 2496	F 2517	G 2538	H 2559	J 2580	K COM 2601	L 2622	M 2643	N 2664	O 2685	P 2706	Q 2727	R 2748	S 2769	T 2790	U 2811	(# above U) * 21 (Riser) + 2811 (U)	S Nail 45	M Nail N/A
Leather 1 N/A		Leather 2 N/A		Leather 3 N/A		Leather 4 N/A		Leather 5 N/A		Leather 6 N/A		Leather 8 N/A		COL N/A		S Nail N/A		M Nail N/A	

Fabric SKU: **6105-04**

Leather SKU: **N/A**

Standard Pillows: N/A **Finish Req:** Y

Standard Cushions: N/A **Standard Finish:**

COM: 1.5 yards **COL:** N/A

Features natural cane accents that was handwoven using the peel of natural rattan. As with any natural product, nature's imperfections and hallmarks will be present in the cane materials. Cane is a handcrafted product with artisanal origins dating back to t

Atlas Arm Chair

Woven Natural Cane

Width: 24 **Depth:** 28.25 **Height:** 43

AH: 25.75 **SH:** 19.25 **SD:** 21 **IW:** 20

Weight: 26 lbs **Cube:** 16.87

D 1425	E 1431	F 1437	G 1443	H 1449	J 1455	K COM 1461	L 1467	M 1473	N 1479	O 1485	P 1491	Q 1497	R 1503	S 1509	T 1515	U 1521	(# above U) * 6 (Riser) + 1521 (U)	S Nail N/A	M Nail N/A
Leather 1 N/A		Leather 2 N/A		Leather 3 N/A		Leather 4 N/A		Leather 5 N/A		Leather 6 N/A		Leather 8 N/A		COL N/A		S Nail N/A		M Nail N/A	

Fabric SKU: **6111-20**

Leather SKU: **L-6111-20**

Standard Pillows: N/A **Finish Req:** Y

Standard Cushions: High Resiliency 30 **Standard Finish:**

COM: 2.25 yards **COL:** 38.7 square feet

Bosley Ottoman

Width: 26.5 **Depth:** 21 **Height:** 17.5

AH: 0 **SH:** 17.5 **SD:** 21 **IW:** 26.5

Weight: 20 lbs **Cube:** 10.77

D 975	E 981	F 987	G 993	H 999	J 1005	K COM 1011	L 1017	M 1023	N 1029	O 1035	P 1041	Q 1047	R 1053	S 1059	T 1065	U 1071	(# above U) * 6 (Riser) + 1071 (U)	S Nail N/A	M Nail 0
Leather 1 1575		Leather 2 1635		Leather 3 1695		Leather 4 1755		Leather 5 1815		Leather 6 1875		Leather 8 2415		COL 1023		S Nail N/A		M Nail Std.	

Fabric SKU: **6111-31**

Leather SKU: **L-6111-31**

Standard Pillows: N/A **Finish Req:** N

Standard Cushions: Ultra Plush **Standard Finish:**

COM: 6.75 yards **COL:** 108.8 square feet

Barry Swivel Chair

Width: 34 **Depth:** 34 **Height:** 34

AH: 27.5 **SH:** 20 **SD:** 20.5 **IW:** 20

Weight: 42 lbs **Cube:** 29.69

D 2145	E 2163	F 2181	G 2199	H 2217	J 2235	K COM 2253	L 2271	M 2289	N 2307	O 2325	P 2343	Q 2361	R 2379	S 2397	T 2415	U 2433	(# above U) * 18 (Riser) + 2433 (U)	S Nail N/A	M Nail 0
Leather 1 3465		Leather 2 3630		Leather 3 3795		Leather 4 3960		Leather 5 4125		Leather 6 4290		Leather 8 5790		COL 2289		S Nail N/A		M Nail Std.	

Fabric SKU: **6111-32**

Leather SKU: **L-6111-32**

Standard Pillows: N/A **Finish Req:** N

Standard Cushions: Ultra Plush **Standard Finish:**

COM: 6.75 yards **COL:** 108.8 square feet

Barry Swivel Glider

Width: 34 **Depth:** 34 **Height:** 34

AH: 27.5 **SH:** 20 **SD:** 20.5 **IW:** 20

Weight: 42 lbs **Cube:** 29.69

D 2295	E 2313	F 2331	G 2349	H 2367	J 2385	K COM 2403	L 2421	M 2439	N 2457	O 2475	P 2493	Q 2511	R 2529	S 2547	T 2565	U 2583	(# above U) * 18 (Riser) + 2583 (U)	S Nail N/A	M Nail 0
Leather 1 3630		Leather 2 3795		Leather 3 3960		Leather 4 4125		Leather 5 4290		Leather 6 4455		Leather 8 5955		COL 2439		S Nail N/A		M Nail Std.	

Upholstery

**Pillows are not available on leather SKUs*

Fabric SKU: 6112-01

Leather SKU: L-6112-01

Standard Pillows: N/A Finish Req: N

Standard Cushions: Ultra Plush Standard Finish:

COM: 6 yards COL: 90 square feet

Marsden Lounge Chair

Width: 29 Depth: 35 Height: 35.25

AH: 24 SH: 19.5 SD: 22 IW: 23

Weight: 62 lbs Cube: 29.69

D	E	F	G	H	J	K COM	L	M	N	O	P	Q	R	S	T	U	(# above U) *	S Nail	M Nail
2145	2163	2181	2199	2217	2235	2253	2271	2289	2307	2325	2343	2361	2379	2397	2415	2433	18 (Riser) + 2433 (U)	75	N/A
Leather 1 3285		Leather 2 3420		Leather 3 3555		Leather 4 3690		Leather 5 3825		Leather 6 3960		Leather 8 5205		COL 2289		S Nail 75		M Nail N/A	

Fabric SKU: 6112-31

Leather SKU: L-6112-31

Standard Pillows: N/A Finish Req: N

Standard Cushions: Ultra Plush Standard Finish:

COM: 6 yards COL: 90 square feet

Marsden Swivel Chair

Width: 29 Depth: 35 Height: 35.25

AH: 24 SH: 19.5 SD: 22 IW: 23

Weight: 62 lbs Cube: 29.69

D	E	F	G	H	J	K COM	L	M	N	O	P	Q	R	S	T	U	(# above U) *	S Nail	M Nail
2220	2238	2256	2274	2292	2310	2328	2346	2364	2382	2400	2418	2436	2454	2472	2490	2508	18 (Riser) + 2508 (U)	75	N/A
Leather 1 3360		Leather 2 3495		Leather 3 3630		Leather 4 3765		Leather 5 3900		Leather 6 4035		Leather 8 5280		COL 2364		S Nail 75		M Nail N/A	

Fabric SKU: 6112-32

Leather SKU: L-6112-32

Standard Pillows: N/A Finish Req: N

Standard Cushions: Ultra Plush Standard Finish:

COM: 6 yards COL: 90 square feet

Marsden Swivel Glider

Width: 29 Depth: 35 Height: 35.25

AH: 24 SH: 19.5 SD: 22 IW: 23

Weight: 62 lbs Cube: 29.69

D	E	F	G	H	J	K COM	L	M	N	O	P	Q	R	S	T	U	(# above U) *	S Nail	M Nail
2370	2388	2406	2424	2442	2460	2478	2496	2514	2532	2550	2568	2586	2604	2622	2640	2658	18 (Riser) + 2658 (U)	75	N/A
Leather 1 3510		Leather 2 3645		Leather 3 3780		Leather 4 3915		Leather 5 4050		Leather 6 4185		Leather 8 5430		COL 2514		S Nail 90		M Nail N/A	

Fabric SKU: 6118-01

Leather SKU: L-6118-01

Standard Pillows: N/A Finish Req: Y

Standard Cushions: Ultra Plush Standard Finish:

COM: 5.25 yards COL: 96 square feet

Manning Lounge Chair

Width: 29 Depth: 32 Height: 32

AH: 27 SH: 21 SD: 22 IW: 22

Weight: 55 lbs Cube: 23.22

D	E	F	G	H	J	K COM	L	M	N	O	P	Q	R	S	T	U	(# above U) *	S Nail	M Nail
2070	2085	2100	2115	2130	2145	2160	2175	2190	2205	2220	2235	2250	2265	2280	2295	2310	15 (Riser) + 2310 (U)	45	60
Leather 1 3150		Leather 2 3300		Leather 3 3450		Leather 4 3600		Leather 5 3750		Leather 6 3900		Leather 8 5220		COL 2190		S Nail 45		M Nail 60	

Fabric SKU: 6118-31

Leather SKU: L-6118-31

Standard Pillows: N/A Finish Req: N

Standard Cushions: Ultra Plush Standard Finish:

COM: 5.25 yards COL: 96 square feet

Manning Swivel Chair

Width: 29 Depth: 32 Height: 32

AH: 27 SH: 21 SD: 22 IW: 22

Weight: 55 lbs Cube: 23.89

D	E	F	G	H	J	K COM	L	M	N	O	P	Q	R	S	T	U	(# above U) *	S Nail	M Nail
2070	2085	2100	2115	2130	2145	2160	2175	2190	2205	2220	2235	2250	2265	2280	2295	2310	15 (Riser) + 2310 (U)	45	60
Leather 1 3150		Leather 2 3300		Leather 3 3450		Leather 4 3600		Leather 5 3750		Leather 6 3900		Leather 8 5220		COL 2190		S Nail 45		M Nail 60	

Fabric SKU: 6120-31

Leather SKU: L-6120-31

Standard Pillows: N/A Finish Req: N

Standard Cushions: Ultra Plush Standard Finish:

COM: 6.25 yards COL: 102 square feet

Standard with leftside facing wireless charger for iPhone & Android Cellular Phones

Paterson Swivel Chair

Wireless Charger

Width: 33.5 Depth: 34 Height: 37.5

AH: 27 SH: 21.5 SD: 21 IW: 23

Weight: 85 lbs Cube: 24.71

D	E	F	G	H	J	K COM	L	M	N	O	P	Q	R	S	T	U	(# above U) *	S Nail	M Nail
2250	2268	2286	2304	2322	2340	2358	2376	2394	2412	2430	2448	2466	2484	2502	2520	2538	18 (Riser) + 2538 (U)	45	60
Leather 1 3555		Leather 2 3720		Leather 3 3885		Leather 4 4050		Leather 5 4215		Leather 6 4380		Leather 8 5790		COL 2394		S Nail 45		M Nail 60	

Upholstery

**Pillows are not available on leather SKUs*

Fabric SKU: **6120-32**

Leather SKU: **L-6120-32**

Paterson Swivel Glider

Wireless Charger

Width: 33.5 **Depth:** 34 **Height:** 37.5

AH: 27 **SH:** 21.5 **SD:** 21 **IW:** 23

Weight: 85 lbs **Cube:** 24.71

Standard Pillows: N/A **Finish Req:** N

Standard Cushions: Ultra Plush **Standard Finish:**

COM: 6.25 yards **COL:** 102 square feet

Standard with leftside facing wireless charger for iPhone & Android Cellular Phones

D	E	F	G	H	J	K COM	L	M	N	O	P	Q	R	S	T	U	(# above U) *	S Nail	M Nail
2400	2418	2436	2454	2472	2490	2508	2526	2544	2562	2580	2598	2616	2634	2652	2670	2688	18 (Riser) + 2688 (U)	45	60
Leather 1 3705		Leather 2 3870		Leather 3 4035		Leather 4 4200		Leather 5 4365		Leather 6 4530		Leather 8 5940		COL 2544		S Nail 45		M Nail 60	

Fabric SKU: **6121-20**

Leather SKU: **L-6121-20**

Paterson Ottoman

Width: 28 **Depth:** 21 **Height:** 19.5

AH: 0 **SH:** 0 **SD:** 0 **IW:** 0

Weight: 30 lbs **Cube:** 10.77

Standard Pillows: N/A **Finish Req:** N

Standard Cushions: High Resiliency 30 **Standard Finish:**

COM: 3.5 yards **COL:** 68 square feet

Standard with four casters

D	E	F	G	H	J	K COM	L	M	N	O	P	Q	R	S	T	U	(# above U) *	S Nail	M Nail
1050	1062	1074	1086	1098	1110	1122	1134	1146	1158	1170	1182	1194	1206	1218	1230	1242	12 (Riser) + 1242 (U)	30	45
Leather 1 1965		Leather 2 2070		Leather 3 2175		Leather 4 2280		Leather 5 2385		Leather 6 2490		Leather 8 3435		COL 1146		S Nail 30		M Nail 45	

Fabric SKU: **6121-31**

Leather SKU: **L-6121-31**

Paterson Swivel Chair

Width: 33.5 **Depth:** 34 **Height:** 37.5

AH: 27 **SH:** 21.5 **SD:** 21 **IW:** 23

Weight: 75 lbs **Cube:** 28.5

Standard Pillows: N/A **Finish Req:** N

Standard Cushions: Ultra Plush **Standard Finish:**

COM: 6.25 yards **COL:** 113 square feet

D	E	F	G	H	J	K COM	L	M	N	O	P	Q	R	S	T	U	(# above U) *	S Nail	M Nail
2100	2118	2136	2154	2172	2190	2208	2226	2244	2262	2280	2298	2316	2334	2352	2370	2388	18 (Riser) + 2388 (U)	45	60
Leather 1 3465		Leather 2 3645		Leather 3 3825		Leather 4 4005		Leather 5 4185		Leather 6 4365		Leather 8 5925		COL 2244		S Nail 45		M Nail 60	

Fabric SKU: **6121-32**

Leather SKU: **L-6121-32**

Paterson Swivel Glider

Width: 33.5 **Depth:** 34 **Height:** 37.5

AH: 27 **SH:** 21.5 **SD:** 21 **IW:** 23

Weight: 75 lbs **Cube:** 28.5

Standard Pillows: N/A **Finish Req:** N

Standard Cushions: Ultra Plush **Standard Finish:**

COM: 6.25 yards **COL:** 113 square feet

D	E	F	G	H	J	K COM	L	M	N	O	P	Q	R	S	T	U	(# above U) *	S Nail	M Nail
2250	2268	2286	2304	2322	2340	2358	2376	2394	2412	2430	2448	2466	2484	2502	2520	2538	18 (Riser) + 2538 (U)	45	60
Leather 1 3630		Leather 2 3810		Leather 3 3990		Leather 4 4170		Leather 5 4350		Leather 6 4530		Leather 8 6090		COL 2394		S Nail 45		M Nail 60	

Fabric SKU: **6122-31**

Leather SKU: **L-6122-31**

Paterson Swivel Chair

UV-C Phone Charger with Sanitation

Width: 33.5 **Depth:** 34 **Height:** 37.5

AH: 27 **SH:** 21.5 **SD:** 21 **IW:** 23

Weight: 85 lbs **Cube:** 24.71

Standard Pillows: N/A **Finish Req:** N

Standard Cushions: Ultra Plush **Standard Finish:**

COM: 6.25 yards **COL:** 102 square feet

Left Side Facing Ultraviolet Disinfecting & Charging unit for iPhone and Android cellular phones.

D	E	F	G	H	J	K COM	L	M	N	O	P	Q	R	S	T	U	(# above U) *	S Nail	M Nail
2250	2268	2286	2304	2322	2340	2358	2376	2394	2412	2430	2448	2466	2484	2502	2520	2538	18 (Riser) + 2538 (U)	45	60
Leather 1 3600		Leather 2 3765		Leather 3 3930		Leather 4 4095		Leather 5 4260		Leather 6 4425		Leather 8 5835		COL 2394		S Nail 45		M Nail 60	

Fabric SKU: **6122-32**

Leather SKU: **L-6122-32**

Paterson Swivel Glider

UV-C Phone Charger with Sanitation

Width: 33.5 **Depth:** 34 **Height:** 37.5

AH: 27 **SH:** 21.5 **SD:** 21 **IW:** 23

Weight: 85 lbs **Cube:** 24.71

Standard Pillows: N/A **Finish Req:** N

Standard Cushions: Ultra Plush **Standard Finish:**

COM: 6.25 yards **COL:** 102 square feet

Left Side Facing Ultraviolet Disinfecting & Charging unit for iPhone and Android cellular phones.

D	E	F	G	H	J	K COM	L	M	N	O	P	Q	R	S	T	U	(# above U) *	S Nail	M Nail
2400	2418	2436	2454	2472	2490	2508	2526	2544	2562	2580	2598	2616	2634	2652	2670	2688	18 (Riser) + 2688 (U)	45	60
Leather 1 3750		Leather 2 3915		Leather 3 4080		Leather 4 4245		Leather 5 4410		Leather 6 4575		Leather 8 5985		COL 2544		S Nail 45		M Nail 60	

Upholstery

**Pillows are not available on leather SKUs*

Fabric SKU: 6138-01

Leather SKU: L-6138-01

Standard Pillows: N/A Finish Req: Y

Standard Cushions: Ultra Plush Standard Finish:

COM: 5.25 yards COL: 96 square feet

Bryson Lounge Chair

Width: 29 Depth: 32 Height: 32

AH: 27 SH: 21 SD: 22 IW: 22

Weight: 55 lbs Cube: 23.89

D	E	F	G	H	J	K COM	L	M	N	O	P	Q	R	S	T	U	(# above U) *	S Nail	M Nail
2085	2100	2115	2130	2145	2160	2175	2190	2205	2220	2235	2250	2265	2280	2295	2310	2325	15 (Riser) + 2325 (U)	45	60
Leather 1 3165		Leather 2 3315		Leather 3 3465		Leather 4 3615		Leather 5 3765		Leather 6 3915		Leather 8 5235		COL 2205		S Nail 45		M Nail 60	

Fabric SKU: 6138-31

Leather SKU: L-6138-31

Standard Pillows: N/A Finish Req: N

Standard Cushions: Ultra Plush Standard Finish:

COM: 5.25 yards COL: 96 square feet

Bryson Swivel Chair

Width: 29 Depth: 32 Height: 32

AH: 27 SH: 21 SD: 22 IW: 22

Weight: 55 lbs Cube: 29.69

D	E	F	G	H	J	K COM	L	M	N	O	P	Q	R	S	T	U	(# above U) *	S Nail	M Nail
2085	2100	2115	2130	2145	2160	2175	2190	2205	2220	2235	2250	2265	2280	2295	2310	2325	15 (Riser) + 2325 (U)	45	60
Leather 1 3165		Leather 2 3315		Leather 3 3465		Leather 4 3615		Leather 5 3765		Leather 6 3915		Leather 8 5235		COL 2205		S Nail 45		M Nail 60	

Fabric SKU: 6196-01

Leather SKU: L-6196-01

Standard Pillows: N/A Finish Req: Y

Standard Cushions: High Resiliency 30 Standard Finish:

COM: 4.5 yards COL: 76.5 square feet

Madison Lounge Chair

Width: 27 Depth: 30.5 Height: 34.5

AH: 24 SH: 19 SD: 19 IW: 20

Weight: 41 lbs Cube: 23.89

D	E	F	G	H	J	K COM	L	M	N	O	P	Q	R	S	T	U	(# above U) *	S Nail	M Nail
1950	1965	1980	1995	2010	2025	2040	2055	2070	2085	2100	2115	2130	2145	2160	2175	2190	15 (Riser) + 2190 (U)	120	N/A
Leather 1 3060		Leather 2 3180		Leather 3 3300		Leather 4 3420		Leather 5 3540		Leather 6 3660		Leather 8 4710		COL 2070		S Nail 120		M Nail N/A	

Fabric SKU: 6196-50

Leather SKU: L-6196-50

Standard Pillows: N/A Finish Req: Y

Standard Cushions: High Resiliency 30 Standard Finish:

COM: 8.75 yards COL: 169 square feet

Madison Sofa

Width: 86.5 Depth: 30.5 Height: 34.5

AH: 24 SH: 19 SD: 19 IW: 79.5

Weight: 96 lbs Cube: 52.67

D	E	F	G	H	J	K COM	L	M	N	O	P	Q	R	S	T	U	(# above U) *	S Nail	M Nail
2985	3009	3033	3057	3081	3105	3129	3153	3177	3201	3225	3249	3273	3297	3321	3345	3369	24 (Riser) + 3369 (U)	270	N/A
Leather 1 4875		Leather 2 5130		Leather 3 5385		Leather 4 5640		Leather 5 5895		Leather 6 6150		Leather 8 8475		COL 3177		S Nail 270		M Nail N/A	

Fabric SKU: 6196-70

Leather SKU: L-6196-70

Standard Pillows: N/A Finish Req: Y

Standard Cushions: High Resiliency 30 Standard Finish:

COM: 6.5 yards COL: 124 square feet

Madison Loveseat

Width: 59 Depth: 30.5 Height: 34.5

AH: 24 SH: 19 SD: 19 IW: 52

Weight: 75 lbs Cube: 35.92

D	E	F	G	H	J	K COM	L	M	N	O	P	Q	R	S	T	U	(# above U) *	S Nail	M Nail
2685	2703	2721	2739	2757	2775	2793	2811	2829	2847	2865	2883	2901	2919	2937	2955	2973	18 (Riser) + 2973 (U)	210	N/A
Leather 1 4050		Leather 2 4245		Leather 3 4440		Leather 4 4635		Leather 5 4830		Leather 6 5025		Leather 8 6735		COL 2829		S Nail 210		M Nail N/A	

Fabric SKU: 6197-01

Leather SKU: L-6197-01

Standard Pillows: N/A Finish Req: Y

Standard Cushions: High Resiliency 30 Standard Finish:

COM: 4.5 yards COL: 85 square feet

Norwood Lounge Chair

Width: 26.5 Depth: 28 Height: 31.5

AH: 24 SH: 19 SD: 18.5 IW: 20.5

Weight: 35 lbs Cube: 21.65

D	E	F	G	H	J	K COM	L	M	N	O	P	Q	R	S	T	U	(# above U) *	S Nail	M Nail
2100	2115	2130	2145	2160	2175	2190	2205	2220	2235	2250	2265	2280	2295	2310	2325	2340	15 (Riser) + 2340 (U)	135	N/A
Leather 1 3225		Leather 2 3360		Leather 3 3495		Leather 4 3630		Leather 5 3765		Leather 6 3900		Leather 8 5070		COL 2220		S Nail 135		M Nail N/A	

Upholstery

**Pillows are not available on leather SKUs*

Fabric SKU: **6197-50**

Leather SKU: **L-6197-50**

Standard Pillows: N/A Finish Req: Y

Standard Cushions: High Resiliency 30 Standard Finish:

COM: 9 yards COL: 175 square feet

Norwood Sofa

Width: 80 Depth: 28.25 Height: 31.5

AH: 25 SH: 18.75 SD: 19 IW: 74

Weight: 93 lbs Cube: 41.19

D	E	F	G	H	J	K COM	L	M	N	O	P	Q	R	S	T	U	(# above U) *	S Nail	M Nail
3150	3177	3204	3231	3258	3285	3312	3339	3366	3393	3420	3447	3474	3501	3528	3555	3582	27 (Riser) + 3582 (U)	240	N/A
Leather 1 5085		Leather 2 5355		Leather 3 5625		Leather 4 5895		Leather 5 6165		Leather 6 6435		Leather 8 8850		COL 3366		S Nail 240		M Nail N/A	

Fabric SKU: **6197-70**

Leather SKU: **L-6197-70**

Standard Pillows: N/A Finish Req: Y

Standard Cushions: High Resiliency 30 Standard Finish:

COM: 8 yards COL: 158 square feet

Norwood Loveseat

Width: 70 Depth: 28.25 Height: 31.5

AH: 25 SH: 18.75 SD: 19 IW: 64

Weight: 80 lbs Cube: 36.04

D	E	F	G	H	J	K COM	L	M	N	O	P	Q	R	S	T	U	(# above U) *	S Nail	M Nail
2925	2949	2973	2997	3021	3045	3069	3093	3117	3141	3165	3189	3213	3237	3261	3285	3309	24 (Riser) + 3309 (U)	225	N/A
Leather 1 4785		Leather 2 5025		Leather 3 5265		Leather 4 5505		Leather 5 5745		Leather 6 5985		Leather 8 8160		COL 3117		S Nail 225		M Nail N/A	

Fabric SKU: **6198-31**

Leather SKU: **L-6198-31**

Standard Pillows: N/A Finish Req: Y

Standard Cushions: Ultra Plush Standard Finish:

COM: 5 yards COL: 96 square feet

Forester Swivel Chair

Width: 29 Depth: 34 Height: 31.75

AH: 25.75 SH: 20 SD: 25 IW: 23

Weight: 73 lbs Cube: 29.69

D	E	F	G	H	J	K COM	L	M	N	O	P	Q	R	S	T	U	(# above U) *	S Nail	M Nail
2745	2760	2775	2790	2805	2820	2835	2850	2865	2880	2895	2910	2925	2940	2955	2970	2985	15 (Riser) + 2985 (U)	75	N/A
Leather 1 4050		Leather 2 4200		Leather 3 4350		Leather 4 4500		Leather 5 4650		Leather 6 4800		Leather 8 6120		COL 2865		S Nail 75		M Nail N/A	

Fabric SKU: **6198-32**

Leather SKU: **L-6198-32**

Standard Pillows: N/A Finish Req: Y

Standard Cushions: Ultra Plush Standard Finish:

COM: 5 yards COL: 96 square feet

Forester Swivel Glider

Width: 29 Depth: 34 Height: 31.75

AH: 25.75 SH: 20 SD: 25 IW: 23

Weight: 73 lbs Cube: 18.11

D	E	F	G	H	J	K COM	L	M	N	O	P	Q	R	S	T	U	(# above U) *	S Nail	M Nail
2895	2910	2925	2940	2955	2970	2985	3000	3015	3030	3045	3060	3075	3090	3105	3120	3135	15 (Riser) + 3135 (U)	75	N/A
Leather 1 4200		Leather 2 4350		Leather 3 4500		Leather 4 4650		Leather 5 4800		Leather 6 4950		Leather 8 6270		COL 3015		S Nail 75		M Nail N/A	

Fabric SKU: **6199-01**

Leather SKU: **L-6199-01**

Standard Pillows: N/A Finish Req: N

Standard Cushions: Classic Plush Standard Finish:

COM: 7.25 yards COL: 107 square feet

Phoebe Lounge Chair

Width: 29.5 Depth: 34 Height: 31.5

AH: 24.5 SH: 20 SD: 25 IW: 23

Weight: 70 lbs Cube: 18.28

D	E	F	G	H	J	K COM	L	M	N	O	P	Q	R	S	T	U	(# above U) *	S Nail	M Nail
2445	2466	2487	2508	2529	2550	2571	2592	2613	2634	2655	2676	2697	2718	2739	2760	2781	21 (Riser) + 2781 (U)	120	135
Leather 1 3975		Leather 2 4140		Leather 3 4305		Leather 4 4470		Leather 5 4635		Leather 6 4800		Leather 8 6270		COL 2613		S Nail 120		M Nail 135	

Fabric SKU: **6199-31**

Leather SKU: **L-6199-31**

Standard Pillows: N/A Finish Req: N

Standard Cushions: Ultra Plush Standard Finish:

COM: 7.25 yards COL: 107 square feet

Phoebe Swivel Chair

Width: 29.5 Depth: 34 Height: 31.5

AH: 24.5 SH: 20 SD: 25 IW: 23

Weight: 68 lbs Cube: 29.69

D	E	F	G	H	J	K COM	L	M	N	O	P	Q	R	S	T	U	(# above U) *	S Nail	M Nail
2520	2541	2562	2583	2604	2625	2646	2667	2688	2709	2730	2751	2772	2793	2814	2835	2856	21 (Riser) + 2856 (U)	120	135
Leather 1 4050		Leather 2 4215		Leather 3 4380		Leather 4 4545		Leather 5 4710		Leather 6 4875		Leather 8 6345		COL 2688		S Nail 120		M Nail 135	

Upholstery

**Pillows are not available on leather SKUs*

Fabric SKU: 6199-32

Leather SKU: L-6199-32

Standard Pillows: N/A Finish Req: N

Standard Cushions: Ultra Plush Standard Finish:

COM: 7.25 yards COL: 118.15 square feet

Phoebe Swivel Glider

Width: 29.5 Depth: 34 Height: 31.5

AH: 24.5 SH: 20 SD: 25 IW: 23

Weight: 68 lbs Cube: 23.89

D	E	F	G	H	J	K COM	L	M	N	O	P	Q	R	S	T	U	(# above U) *	S Nail	M Nail
2670	2691	2712	2733	2754	2775	2796	2817	2838	2859	2880	2901	2922	2943	2964	2985	3006	21 (Riser) + 3006 (U)	120	135
Leather 1 4200		Leather 2 4380		Leather 3 4560		Leather 4 4740		Leather 5 4920		Leather 6 5100		Leather 8 6735		COL 2838		S Nail 120		M Nail 135	

Fabric SKU: 6200-01-2

Leather SKU: N/A

Standard Pillows: (1) Kidney Finish Req: N

Standard Cushions: High Resiliency 30 Standard Finish: Nickel

COM: 4.75 yards COL: N/A

Salinas Lounge Chair

Width: 29.5 Depth: 32 Height: 32

AH: 24.5 SH: 19 SD: 19 IW: 23

Weight: 60 lbs Cube: 17.48

D	E	F	G	H	J	K COM	L	M	N	O	P	Q	R	S	T	U	(# above U) *	S Nail	M Nail
2175	2190	2205	2220	2235	2250	2265	2280	2295	2310	2325	2340	2355	2370	2385	2400	2415	15 (Riser) + 2415 (U)	90	N/A
Leather 1 N/A		Leather 2 N/A		Leather 3 N/A		Leather 4 N/A		Leather 5 N/A		Leather 6 N/A		Leather 8 N/A		COL N/A		S Nail N/A		M Nail N/A	

Fabric SKU: 6200-01-8

Leather SKU: N/A

Standard Pillows: (1) Kidney Finish Req: N

Standard Cushions: High Resiliency 30 Standard Finish: Gold

COM: 4.75 yards COL: N/A

Salinas Lounge Chair

Width: 29.5 Depth: 32 Height: 32

AH: 24.5 SH: 19 SD: 19 IW: 23

Weight: 60 lbs Cube: 17.48

D	E	F	G	H	J	K COM	L	M	N	O	P	Q	R	S	T	U	(# above U) *	S Nail	M Nail
2175	2190	2205	2220	2235	2250	2265	2280	2295	2310	2325	2340	2355	2370	2385	2400	2415	15 (Riser) + 2415 (U)	90	N/A
Leather 1 N/A		Leather 2 N/A		Leather 3 N/A		Leather 4 N/A		Leather 5 N/A		Leather 6 N/A		Leather 8 N/A		COL N/A		S Nail N/A		M Nail N/A	

Fabric SKU: 6201-01-2

Leather SKU: L-6201-01-2

Standard Pillows: N/A Finish Req: N

Standard Cushions: Ultra Plush Standard Finish: Nickel

COM: 5.25 yards COL: 85.85 square feet

Rivoli Lounge Chair

Width: 32 Depth: 33 Height: 30.5

AH: 23 SH: 19 SD: 23 IW: 22

Weight: 39 lbs Cube: 29.69

D	E	F	G	H	J	K COM	L	M	N	O	P	Q	R	S	T	U	(# above U) *	S Nail	M Nail
2385	2400	2415	2430	2445	2460	2475	2490	2505	2520	2535	2550	2565	2580	2595	2610	2625	15 (Riser) + 2625 (U)	N/A	N/A
Leather 1 3465		Leather 2 3600		Leather 3 3735		Leather 4 3870		Leather 5 4005		Leather 6 4140		Leather 8 5325		COL 2505		S Nail N/A		M Nail N/A	

Fabric SKU: 6201-01-7

Leather SKU: L-6201-01-7

Standard Pillows: N/A Finish Req: N

Standard Cushions: Ultra Plush Standard Finish: Bright Brass

COM: 5.25 yards COL: 85.85 square feet

Rivoli Lounge Chair

Width: 32 Depth: 33 Height: 30.5

AH: 23 SH: 19 SD: 23 IW: 22

Weight: 39 lbs Cube: 29.69

D	E	F	G	H	J	K COM	L	M	N	O	P	Q	R	S	T	U	(# above U) *	S Nail	M Nail
2385	2400	2415	2430	2445	2460	2475	2490	2505	2520	2535	2550	2565	2580	2595	2610	2625	15 (Riser) + 2625 (U)	N/A	N/A
Leather 1 3465		Leather 2 3600		Leather 3 3735		Leather 4 3870		Leather 5 4005		Leather 6 4140		Leather 8 5325		COL 2505		S Nail N/A		M Nail N/A	

Fabric SKU: 6203-01-2

Leather SKU: L-6203-01-2

Standard Pillows: N/A Finish Req: N

Standard Cushions: High Resiliency 40 Standard Finish: Nickel

COM: 5.5 yards COL: 90.95 square feet

Capri Lounge Chair

Width: 31.5 Depth: 33 Height: 31

AH: 23 SH: 17.5 SD: 22 IW: 21.5

Weight: 47 lbs Cube: 23.89

D	E	F	G	H	J	K COM	L	M	N	O	P	Q	R	S	T	U	(# above U) *	S Nail	M Nail
2250	2265	2280	2295	2310	2325	2340	2355	2370	2385	2400	2415	2430	2445	2460	2475	2490	15 (Riser) + 2490 (U)	N/A	N/A
Leather 1 3300		Leather 2 3435		Leather 3 3570		Leather 4 3705		Leather 5 3840		Leather 6 3975		Leather 8 5235		COL 2370		S Nail N/A		M Nail N/A	

Upholstery

**Pillows are not available on leather SKUs*

Fabric SKU: **6203-01-7**

Leather SKU: **L-6203-01-7**

Standard Pillows: N/A Finish Req: N

Standard Cushions: High Resiliency 40 Standard Finish: Bright Brass

COM: 5.5 yards COL: 90.95 square feet

Capri Lounge Chair

Width: 31.5 Depth: 33 Height: 31

AH: 23 SH: 17.5 SD: 22 IW: 21.5

Weight: 47 lbs Cube: 29.69

D	E	F	G	H	J	K COM	L	M	N	O	P	Q	R	S	T	U	(# above U) *	S Nail	M Nail
2250	2265	2280	2295	2310	2325	2340	2355	2370	2385	2400	2415	2430	2445	2460	2475	2490	15 (Riser) + 2490 (U)	N/A	N/A
Leather 1 3300		Leather 2 3435		Leather 3 3570		Leather 4 3705		Leather 5 3840		Leather 6 3975		Leather 8 5235		COL 2370		S Nail N/A		M Nail N/A	

Fabric SKU: **6204-01-2**

Leather SKU: **L-6204-01-2**

Standard Pillows: N/A Finish Req: N

Standard Cushions: High Resiliency 40 Standard Finish: Nickel

COM: 5 yards COL: 81.6 square feet

Verona Lounge Chair

Width: 30.5 Depth: 32.5 Height: 32

AH: 22 SH: 17.5 SD: 22 IW: 22.5

Weight: 47 lbs Cube: 29.69

D	E	F	G	H	J	K COM	L	M	N	O	P	Q	R	S	T	U	(# above U) *	S Nail	M Nail
2250	2265	2280	2295	2310	2325	2340	2355	2370	2385	2400	2415	2430	2445	2460	2475	2490	15 (Riser) + 2490 (U)	N/A	N/A
Leather 1 3225		Leather 2 3345		Leather 3 3465		Leather 4 3585		Leather 5 3705		Leather 6 3825		Leather 8 4950		COL 2370		S Nail N/A		M Nail N/A	

Fabric SKU: **6204-01-7**

Leather SKU: **L-6204-01-7**

Standard Pillows: N/A Finish Req: N

Standard Cushions: High Resiliency 40 Standard Finish: Bright Brass

COM: 5 yards COL: 81.6 square feet

Verona Lounge Chair

Width: 30.5 Depth: 32.5 Height: 32

AH: 22 SH: 17.5 SD: 22 IW: 22.5

Weight: 47 lbs Cube: 29.69

D	E	F	G	H	J	K COM	L	M	N	O	P	Q	R	S	T	U	(# above U) *	S Nail	M Nail
2250	2265	2280	2295	2310	2325	2340	2355	2370	2385	2400	2415	2430	2445	2460	2475	2490	15 (Riser) + 2490 (U)	N/A	N/A
Leather 1 3225		Leather 2 3345		Leather 3 3465		Leather 4 3585		Leather 5 3705		Leather 6 3825		Leather 8 4950		COL 2370		S Nail N/A		M Nail N/A	

Fabric SKU: **6205-01**

Leather SKU: **L-6205-01**

Standard Pillows: N/A Finish Req: Y

Standard Cushions: High Resiliency 40 Standard Finish:

COM: 3.75 yards COL: 63 square feet

Brixton Occasional Chair

Width: 28.5 Depth: 32 Height: 34.5

AH: 24.5 SH: 19 SD: 20 IW: 24

Weight: 30 lbs Cube: 29.69

D	E	F	G	H	J	K COM	L	M	N	O	P	Q	R	S	T	U	(# above U) *	S Nail	M Nail
1875	1887	1899	1911	1923	1935	1947	1959	1971	1983	1995	2007	2019	2031	2043	2055	2067	12 (Riser) + 2067 (U)	N/A	N/A
Leather 1 2745		Leather 2 2850		Leather 3 2955		Leather 4 3060		Leather 5 3165		Leather 6 3270		Leather 8 4140		COL 1971		S Nail N/A		M Nail N/A	

Fabric SKU: **6207-01-6**

Leather SKU: **L-6207-01-6**

Standard Pillows: N/A Finish Req: N

Standard Cushions: Ultra Plush Standard Finish: Brushed Brass

COM: 4 yards COL: 67.5 square feet

Gramercy Occasional Chair

Width: 29.25 Depth: 32 Height: 34

AH: 22.75 SH: 20 SD: 20 IW: 25

Weight: 46 lbs Cube: 29.69

D	E	F	G	H	J	K COM	L	M	N	O	P	Q	R	S	T	U	(# above U) *	S Nail	M Nail
2805	2817	2829	2841	2853	2865	2877	2889	2901	2913	2925	2937	2949	2961	2973	2985	2997	12 (Riser) + 2997 (U)	N/A	N/A
Leather 1 3615		Leather 2 3720		Leather 3 3825		Leather 4 3930		Leather 5 4035		Leather 6 4140		Leather 8 5070		COL 2901		S Nail N/A		M Nail N/A	

Fabric SKU: **6208-04**

Leather SKU: **N/A**

Standard Pillows: N/A Finish Req: Y

Standard Cushions: High Resiliency 50 Standard Finish:

COM: 2.5 yards COL: N/A

Hayward Arm Chair

Width: 22.5 Depth: 26 Height: 34.25

AH: 29 SH: 19 SD: 19.5 IW: 22.5

Weight: 22 lbs Cube: 11.59

D	E	F	G	H	J	K COM	L	M	N	O	P	Q	R	S	T	U	(# above U) *	S Nail	M Nail
1425	1434	1443	1452	1461	1470	1479	1488	1497	1506	1515	1524	1533	1542	1551	1560	1569	9 (Riser) + 1569 (U)	45	N/A
Leather 1 N/A		Leather 2 N/A		Leather 3 N/A		Leather 4 N/A		Leather 5 N/A		Leather 6 N/A		Leather 8 N/A		COL N/A		S Nail N/A		M Nail N/A	

Upholstery

**Pillows are not available on leather SKUs*

Fabric SKU: **6208-04-C**

Leather SKU: **N/A**

Hayward Arm Chair

Charcoal Finish

Width: 22.5 **Depth:** 26 **Height:** 34.25

AH: 29 **SH:** 19 **SD:** 19.5 **IW:** 22.5

Weight: 22 lbs **Cube:** 11.59

Standard Pillows: N/A **Finish Req:** N

Standard Cushions: High Resiliency 50 **Standard Finish:** Charcoal

COM: 2.5 yards **COL:** N/A

Standard in Charcoal Finish

D	E	F	G	H	J	K COM	L	M	N	O	P	Q	R	S	T	U	(# above U) *	S Nail	M Nail
1185	1194	1203	1212	1221	1230	1239	1248	1257	1266	1275	1284	1293	1302	1311	1320	1329	9 (Riser) + 1329 (U)	45	N/A
Leather 1		Leather 2		Leather 3		Leather 4		Leather 5		Leather 6		Leather 8		COL		S Nail		M Nail	
N/A		N/A		N/A		N/A		N/A		N/A		N/A		N/A		N/A		N/A	

Fabric SKU: **6300-50-2**

Leather SKU: **N/A**

LIBBY LANGDON FOR FAIRFIELD

Tanner Sofa

Width: 78.75 **Depth:** 34 **Height:** 33.75

AH: 23.25 **SH:** 19 **SD:** 23 **IW:** 68

Weight: 108 lbs **Cube:** 68.15

Standard Pillows: (2) 20 x 20 **Finish Req:** N

Standard Cushions: High Resiliency 35 **Standard Finish:** Nickel

COM: 8 yards **COL:** N/A

D	E	F	G	H	J	K COM	L	M	N	O	P	Q	R	S	T	U	(# above U) *	S Nail	M Nail
3675	3705	3735	3765	3795	3825	3855	3885	3915	3945	3975	4005	4035	4065	4095	4125	4155	30 (Riser) + 4155 (U)	75	N/A
Leather 1		Leather 2		Leather 3		Leather 4		Leather 5		Leather 6		Leather 8		COL		S Nail		M Nail	
N/A		N/A		N/A		N/A		N/A		N/A		N/A		N/A		N/A		N/A	

Fabric SKU: **6300-50-6**

Leather SKU: **N/A**

LIBBY LANGDON FOR FAIRFIELD

Tanner Sofa

Width: 78.75 **Depth:** 34 **Height:** 33.75

AH: 23.25 **SH:** 19 **SD:** 23 **IW:** 68

Weight: 108 lbs **Cube:** 68.15

Standard Pillows: (2) 20 x 20 **Finish Req:** N

Standard Cushions: High Resiliency 35 **Standard Finish:** Brushed Brass

COM: 8 yards **COL:** N/A

Standard with Brushed Brass finish.

D	E	F	G	H	J	K COM	L	M	N	O	P	Q	R	S	T	U	(# above U) *	S Nail	M Nail
3675	3705	3735	3765	3795	3825	3855	3885	3915	3945	3975	4005	4035	4065	4095	4125	4155	30 (Riser) + 4155 (U)	75	N/A
Leather 1		Leather 2		Leather 3		Leather 4		Leather 5		Leather 6		Leather 8		COL		S Nail		M Nail	
N/A		N/A		N/A		N/A		N/A		N/A		N/A		N/A		N/A		N/A	

Fabric SKU: **6301-26**

Leather SKU: **N/A**

LIBBY LANGDON FOR FAIRFIELD

Derring Right Arm Facing Chaise

Width: 71 **Depth:** 37 **Height:** 39

AH: 0 **SH:** 20.5 **SD:** 22 **IW:** 0

Weight: 91 lbs **Cube:** 70.78

Standard Pillows: (1) 18 x 18 **Finish Req:** Y

Standard Cushions: Blendown **Standard Finish:**

COM: 9.5 yards **COL:** N/A

Brushed Brass ferrule. Features spaced back pillows.

D	E	F	G	H	J	K COM	L	M	N	O	P	Q	R	S	T	U	(# above U) *	S Nail	M Nail
3525	3552	3579	3606	3633	3660	3687	3714	3741	3768	3795	3822	3849	3876	3903	3930	3957	27 (Riser) + 3957 (U)	N/A	N/A
Leather 1		Leather 2		Leather 3		Leather 4		Leather 5		Leather 6		Leather 8		COL		S Nail		M Nail	
N/A		N/A		N/A		N/A		N/A		N/A		N/A		N/A		N/A		N/A	

Fabric SKU: **6301-27**

Leather SKU: **N/A**

LIBBY LANGDON FOR FAIRFIELD

Derring Left Arm Facing Chaise

Width: 71 **Depth:** 37 **Height:** 39

AH: 0 **SH:** 20.5 **SD:** 22 **IW:** 0

Weight: 91 lbs **Cube:** 70.78

Standard Pillows: (1) 18 x 18 **Finish Req:** Y

Standard Cushions: Blendown **Standard Finish:**

COM: 9.5 yards **COL:** N/A

Brushed Brass ferrule. Features spaced back pillows.

D	E	F	G	H	J	K COM	L	M	N	O	P	Q	R	S	T	U	(# above U) *	S Nail	M Nail
3525	3552	3579	3606	3633	3660	3687	3714	3741	3768	3795	3822	3849	3876	3903	3930	3957	27 (Riser) + 3957 (U)	N/A	N/A
Leather 1		Leather 2		Leather 3		Leather 4		Leather 5		Leather 6		Leather 8		COL		S Nail		M Nail	
N/A		N/A		N/A		N/A		N/A		N/A		N/A		N/A		N/A		N/A	

Fabric SKU: **6301-50**

Leather SKU: **N/A**

LIBBY LANGDON FOR FAIRFIELD

Derring Sofa

Width: 81 **Depth:** 37 **Height:** 39

AH: 24 **SH:** 20.5 **SD:** 22 **IW:** 70

Weight: 122 lbs **Cube:** 73.53

Standard Pillows: (2) 18 x 18 (2) 20 x 20 **Finish Req:** Y

Standard Cushions: Blendown **Standard Finish:**

COM: 15.75 yards **COL:** N/A

Beech post with Brushed Brass ferrule. Features spaced back pillows.

D	E	F	G	H	J	K COM	L	M	N	O	P	Q	R	S	T	U	(# above U) *	S Nail	M Nail
4785	4830	4875	4920	4965	5010	5055	5100	5145	5190	5235	5280	5325	5370	5415	5460	5505	45 (Riser) + 5505 (U)	N/A	N/A
Leather 1		Leather 2		Leather 3		Leather 4		Leather 5		Leather 6		Leather 8		COL		S Nail		M Nail	
N/A		N/A		N/A		N/A		N/A		N/A		N/A		N/A		N/A		N/A	

Upholstery

**Pillows are not available on leather SKUs*

Fabric SKU: **6301-53** Leather SKU: **N/A**

LIBBY LANGDON FOR FAIRFIELD
Derring Right Arm Facing Corner Sofa

Standard Pillows: (3) 20 x 20 (2) 18 x 18 **Finish Req:** Y

Standard Cushions: Blendown **Standard Finish:**
COM: 21.75 yards **COL:** N/A
 Brushed Brass ferrule. Features spaced back pillows.

Width: 111 **Depth:** 37 **Height:** 39
AH: 34 **SH:** 20.5 **SD:** 22 **IW:** 105
Weight: 153 lbs **Cube:** 81.85

D	E	F	G	H	J	K COM	L	M	N	O	P	Q	R	S	T	U	(# above U) *	S Nail	M Nail
5685	5745	5805	5865	5925	5985	6045	6105	6165	6225	6285	6345	6405	6465	6525	6585	6645	60 (Riser) + 6645 (U)	N/A	N/A
Leather 1 N/A		Leather 2 N/A		Leather 3 N/A		Leather 4 N/A		Leather 5 N/A		Leather 6 N/A		Leather 8 N/A		COL N/A		S Nail N/A		M Nail N/A	

Fabric SKU: **6301-54** Leather SKU: **N/A**

LIBBY LANGDON FOR FAIRFIELD
Derring Left Arm Facing Corner Sofa

Standard Pillows: (3) 20 x 20 (2) 18 x 18 **Finish Req:** Y

Standard Cushions: Blendown **Standard Finish:**
COM: 21.75 yards **COL:** N/A
 Brushed Brass ferrule. Features spaced back pillows.

Width: 111 **Depth:** 37 **Height:** 39
AH: 34 **SH:** 20.5 **SD:** 22 **IW:** 105
Weight: 153 lbs **Cube:** 81.85

D	E	F	G	H	J	K COM	L	M	N	O	P	Q	R	S	T	U	(# above U) *	S Nail	M Nail
5685	5745	5805	5865	5925	5985	6045	6105	6165	6225	6285	6345	6405	6465	6525	6585	6645	60 (Riser) + 6645 (U)	N/A	N/A
Leather 1 N/A		Leather 2 N/A		Leather 3 N/A		Leather 4 N/A		Leather 5 N/A		Leather 6 N/A		Leather 8 N/A		COL N/A		S Nail N/A		M Nail N/A	

Fabric SKU: **6301-67** Leather SKU: **N/A**

LIBBY LANGDON FOR FAIRFIELD
Derring Bumper Ottoman

Standard Pillows: N/A **Finish Req:** Y

Standard Cushions: Blendown **Standard Finish:**
COM: 3.75 yards **COL:** N/A
 Brushed Brass ferrule.

Width: 36 **Depth:** 29 **Height:** 20.5
AH: 0 **SH:** 20.5 **SD:** 29 **IW:** 36
Weight: 26 lbs **Cube:** 16.92

D	E	F	G	H	J	K COM	L	M	N	O	P	Q	R	S	T	U	(# above U) *	S Nail	M Nail
1650	1662	1674	1686	1698	1710	1722	1734	1746	1758	1770	1782	1794	1806	1818	1830	1842	12 (Riser) + 1842 (U)	N/A	N/A
Leather 1 N/A		Leather 2 N/A		Leather 3 N/A		Leather 4 N/A		Leather 5 N/A		Leather 6 N/A		Leather 8 N/A		COL N/A		S Nail N/A		M Nail N/A	

Fabric SKU: **6301-71** Leather SKU: **N/A**

LIBBY LANGDON FOR FAIRFIELD
Derring Right Arm Facing Loveseat

Standard Pillows: (2) 20 x 20 (1) 18 x 18 **Finish Req:** Y

Standard Cushions: Blendown **Standard Finish:**
COM: 15 yards **COL:** N/A
 Brushed Brass ferrule. Features spaced back pillows.

Width: 76 **Depth:** 37 **Height:** 39
AH: 34 **SH:** 20.5 **SD:** 22 **IW:** 70
Weight: 106 lbs **Cube:** 70.78

D	E	F	G	H	J	K COM	L	M	N	O	P	Q	R	S	T	U	(# above U) *	S Nail	M Nail
4485	4533	4581	4629	4677	4725	4773	4821	4869	4917	4965	5013	5061	5109	5157	5205	5253	48 (Riser) + 5253 (U)	N/A	N/A
Leather 1 N/A		Leather 2 N/A		Leather 3 N/A		Leather 4 N/A		Leather 5 N/A		Leather 6 N/A		Leather 8 N/A		COL N/A		S Nail N/A		M Nail N/A	

Fabric SKU: **6301-72** Leather SKU: **N/A**

LIBBY LANGDON FOR FAIRFIELD
Derring Left Arm Facing Loveseat

Standard Pillows: (2) 20 x 20 (1) 18 x 18 **Finish Req:** Y

Standard Cushions: Blendown **Standard Finish:**
COM: 15 yards **COL:** N/A
 Brushed Brass ferrule. Features spaced back pillows.

Width: 76 **Depth:** 37 **Height:** 39
AH: 34 **SH:** 20.5 **SD:** 22 **IW:** 70
Weight: 106 lbs **Cube:** 70.78

D	E	F	G	H	J	K COM	L	M	N	O	P	Q	R	S	T	U	(# above U) *	S Nail	M Nail
4485	4533	4581	4629	4677	4725	4773	4821	4869	4917	4965	5013	5061	5109	5157	5205	5253	48 (Riser) + 5253 (U)	N/A	N/A
Leather 1 N/A		Leather 2 N/A		Leather 3 N/A		Leather 4 N/A		Leather 5 N/A		Leather 6 N/A		Leather 8 N/A		COL N/A		S Nail N/A		M Nail N/A	

Fabric SKU: **6302-50** Leather SKU: **L-6302-50**

LIBBY LANGDON FOR FAIRFIELD
Ryerson Sofa

Standard Pillows: (2) 20 x 20 **Finish Req:** Y

Standard Cushions: Blendown **Standard Finish:**
COM: 14.25 yards **COL:** 220 square feet
 Features bench seat cushion.

Bench Seat Cushion
Width: 86.5 **Depth:** 38 **Height:** 30.5
AH: 24.5 **SH:** 20.5 **SD:** 23 **IW:** 76
Weight: 160 lbs **Cube:** 79.34

D	E	F	G	H	J	K COM	L	M	N	O	P	Q	R	S	T	U	(# above U) *	S Nail	M Nail
5085	5127	5169	5211	5253	5295	5337	5379	5421	5463	5505	5547	5589	5631	5673	5715	5757	42 (Riser) + 5757 (U)	N/A	N/A
Leather 1 7806		Leather 2 8136		Leather 3 8466		Leather 4 8796		Leather 5 9126		Leather 6 9456		Leather 8 12486		COL 5421		S Nail N/A		M Nail N/A	

Upholstery

**Pillows are not available on leather SKUs*

Fabric SKU: **6303-50** Leather SKU: **L-6303-50**
 LIBBY LANGDON FOR FAIRFIELD
Barrett Sofa
 Bench Seat Cushion
Width: 84.75 **Depth:** 36.5 **Height:** 33
AH: 24.25 **SH:** 20.75 **SD:** 21 **IW:** 74
Weight: 130 lbs **Cube:** 79.34

Standard Pillows: (2) 20 x 20 **Finish Req:** Y
Standard Cushions: Blendown **Standard Finish:**
COM: 14.5 yards **COL:** 209 square feet
 Features bench seat cushion.

D	E	F	G	H	J	K COM	L	M	N	O	P	Q	R	S	T	U	(# above U) *	S Nail	M Nail
4875	4920	4965	5010	5055	5100	5145	5190	5235	5280	5325	5370	5415	5460	5505	5550	5595	45 (Riser) + 5595 (U)	90	105
Leather 1 8250		Leather 2 8565		Leather 3 8880		Leather 4 9195		Leather 5 9510		Leather 6 9825		Leather 8 12705		COL 5235		S Nail 90		M Nail 105	

Fabric SKU: **6304-01** Leather SKU: **L-6304-01**
 LIBBY LANGDON FOR FAIRFIELD
Remy Lounge Chair

Standard Pillows: N/A **Finish Req:** Y
Standard Cushions: Blendown **Standard Finish:**
COM: 7 yards **COL:** 113 square feet

Width: 32.5 **Depth:** 38 **Height:** 37
AH: 23.5 **SH:** 20 **SD:** 22 **IW:** 23
Weight: 58 lbs **Cube:** 36.49

D	E	F	G	H	J	K COM	L	M	N	O	P	Q	R	S	T	U	(# above U) *	S Nail	M Nail
2700	2721	2742	2763	2784	2805	2826	2847	2868	2889	2910	2931	2952	2973	2994	3015	3036	21 (Riser) + 3036 (U)	45	60
Leather 1 4245		Leather 2 4425		Leather 3 4605		Leather 4 4785		Leather 5 4965		Leather 6 5145		Leather 8 6705		COL 2868		S Nail 45		M Nail 60	

Fabric SKU: **6304-01-9** Leather SKU: **L-6304-01-9**
 LIBBY LANGDON FOR FAIRFIELD
Remy Lounge Chair

Standard Pillows: N/A **Finish Req:** N
Standard Cushions: Blendown **Standard Finish:** Champagne
COM: 7 yards **COL:** 113 square feet

Width: 32.5 **Depth:** 38 **Height:** 37
AH: 23.5 **SH:** 20 **SD:** 22 **IW:** 23
Weight: 58 lbs **Cube:** 36.49

D	E	F	G	H	J	K COM	L	M	N	O	P	Q	R	S	T	U	(# above U) *	S Nail	M Nail
2775	2796	2817	2838	2859	2880	2901	2922	2943	2964	2985	3006	3027	3048	3069	3090	3111	21 (Riser) + 3111 (U)	45	60
Leather 1 4245		Leather 2 4425		Leather 3 4605		Leather 4 4785		Leather 5 4965		Leather 6 5145		Leather 8 6705		COL 2943		S Nail 45		M Nail 60	

Fabric SKU: **6304-20** Leather SKU: **L-6304-20**
 LIBBY LANGDON FOR FAIRFIELD
Remy Ottoman

Standard Pillows: N/A **Finish Req:** Y
Standard Cushions: High Resiliency 30 **Standard Finish:**
COM: 3.25 yards **COL:** 51 square feet

Width: 31 **Depth:** 23 **Height:** 19
AH: 0 **SH:** 0 **SD:** 0 **IW:** 0
Weight: 23 lbs **Cube:** 10.77

D	E	F	G	H	J	K COM	L	M	N	O	P	Q	R	S	T	U	(# above U) *	S Nail	M Nail
1320	1329	1338	1347	1356	1365	1374	1383	1392	1401	1410	1419	1428	1437	1446	1455	1464	9 (Riser) + 1464 (U)	30	45
Leather 1 2085		Leather 2 2160		Leather 3 2235		Leather 4 2310		Leather 5 2385		Leather 6 2460		Leather 8 3165		COL 1392		S Nail 30		M Nail 45	

Fabric SKU: **6304-20-9** Leather SKU: **L-6304-20-9**
 LIBBY LANGDON FOR FAIRFIELD
Remy Ottoman

Standard Pillows: N/A **Finish Req:** N
Standard Cushions: High Resiliency 30 **Standard Finish:** Champagne
COM: 3.25 yards **COL:** 51 square feet

Width: 31 **Depth:** 23 **Height:** 19
AH: 0 **SH:** 0 **SD:** 0 **IW:** 0
Weight: 23 lbs **Cube:** 10.77

D	E	F	G	H	J	K COM	L	M	N	O	P	Q	R	S	T	U	(# above U) *	S Nail	M Nail
1410	1419	1428	1437	1446	1455	1464	1473	1482	1491	1500	1509	1518	1527	1536	1545	1554	9 (Riser) + 1554 (U)	30	45
Leather 1 2160		Leather 2 2235		Leather 3 2310		Leather 4 2385		Leather 5 2460		Leather 6 2535		Leather 8 3240		COL 1482		S Nail 30		M Nail 45	

Fabric SKU: **6304-50** Leather SKU: **L-6304-50**
 LIBBY LANGDON FOR FAIRFIELD
Remy Sofa

Standard Pillows: (2) 20 x 20 **Finish Req:** Y
Standard Cushions: Blendown **Standard Finish:**
COM: 16.5 yards **COL:** 225 square feet

Width: 86.5 **Depth:** 38 **Height:** 37
AH: 23.5 **SH:** 20 **SD:** 22 **IW:** 77
Weight: 130 lbs **Cube:** 79.34

D	E	F	G	H	J	K COM	L	M	N	O	P	Q	R	S	T	U	(# above U) *	S Nail	M Nail
4875	4920	4965	5010	5055	5100	5145	5190	5235	5280	5325	5370	5415	5460	5505	5550	5595	45 (Riser) + 5595 (U)	75	90
Leather 1 8340		Leather 2 8685		Leather 3 9030		Leather 4 9375		Leather 5 9720		Leather 6 10065		Leather 8 13170		COL 5235		S Nail 75		M Nail 90	

Upholstery

**Pillows are not available on leather SKUs*

Fabric SKU: **6304-50-9** Leather SKU: **L-6304-50-9**
LIBBY LANGDON FOR FAIRFIELD
Remy Sofa

Standard Pillows: (2) 20 x 20 **Finish Req:** N
Standard Cushions: Blendown **Standard Finish:** Champagne
COM: 16.5 yards **COL:** 225 square feet

Width: 86.5 **Depth:** 38 **Height:** 37
AH: 23.5 **SH:** 20 **SD:** 22 **IW:** 77
Weight: 130 lbs **Cube:** 79.34

D	E	F	G	H	J	K COM	L	M	N	O	P	Q	R	S	T	U	(# above U) *	S Nail	M Nail
5100	5145	5190	5235	5280	5325	5370	5415	5460	5505	5550	5595	5640	5685	5730	5775	5820	45 (Riser) + 5820 (U)	75	90
Leather 1 8505		Leather 2 8850		Leather 3 9195		Leather 4 9540		Leather 5 9885		Leather 6 10230		Leather 8 13335		COL 5460		S Nail 75		M Nail 90	

Fabric SKU: **6305-01** Leather SKU: **L-6305-01**
LIBBY LANGDON FOR FAIRFIELD
Harry Lounge Chair

Standard Pillows: N/A **Finish Req:** Y
Standard Cushions: Blendown **Standard Finish:**
COM: 7 yards **COL:** 119 square feet

Width: 32.5 **Depth:** 39.5 **Height:** 35
AH: 24.5 **SH:** 20.5 **SD:** 22.5 **IW:** 23
Weight: 63 lbs **Cube:** 36.49

D	E	F	G	H	J	K COM	L	M	N	O	P	Q	R	S	T	U	(# above U) *	S Nail	M Nail
2925	2946	2967	2988	3009	3030	3051	3072	3093	3114	3135	3156	3177	3198	3219	3240	3261	21 (Riser) + 3261 (U)	60	N/A
Leather 1 4425		Leather 2 4605		Leather 3 4785		Leather 4 4965		Leather 5 5145		Leather 6 5325		Leather 8 6960		COL 3093		S Nail 60		M Nail N/A	

Fabric SKU: **6305-20** Leather SKU: **L-6305-20**
LIBBY LANGDON FOR FAIRFIELD
Harry Ottoman

Standard Pillows: N/A **Finish Req:** Y
Standard Cushions: Blendown **Standard Finish:**
COM: 2.5 yards **COL:** 51 square feet

Width: 24.5 **Depth:** 19.5 **Height:** 18.5
AH: 0 **SH:** 0 **SD:** 0 **IW:** 0
Weight: 16 lbs **Cube:** 5.11

D	E	F	G	H	J	K COM	L	M	N	O	P	Q	R	S	T	U	(# above U) *	S Nail	M Nail
1125	1134	1143	1152	1161	1170	1179	1188	1197	1206	1215	1224	1233	1242	1251	1260	1269	9 (Riser) + 1269 (U)	30	N/A
Leather 1 1815		Leather 2 1890		Leather 3 1965		Leather 4 2040		Leather 5 2115		Leather 6 2190		Leather 8 2895		COL 1197		S Nail 30		M Nail N/A	

Fabric SKU: **6305-50** Leather SKU: **L-6305-50**
LIBBY LANGDON FOR FAIRFIELD
Harry Sofa

Standard Pillows: (2) 20 x 20 **Finish Req:** Y
Standard Cushions: Ultra Plush **Standard Finish:**
COM: 16.25 yards **COL:** 231 square feet

Width: 85.5 **Depth:** 39.5 **Height:** 35
AH: 24.5 **SH:** 20.5 **SD:** 22.5 **IW:** 75
Weight: 131 lbs **Cube:** 79.34

D	E	F	G	H	J	K COM	L	M	N	O	P	Q	R	S	T	U	(# above U) *	S Nail	M Nail
5085	5133	5181	5229	5277	5325	5373	5421	5469	5517	5565	5613	5661	5709	5757	5805	5853	48 (Riser) + 5853 (U)	105	120
Leather 1 8370		Leather 2 8715		Leather 3 9060		Leather 4 9405		Leather 5 9750		Leather 6 10095		Leather 8 13275		COL 5469		S Nail 105		M Nail 120	

Fabric SKU: **6311-26** Leather SKU: **N/A**
LIBBY LANGDON FOR FAIRFIELD
Derring Right Arm Facing Chaise

Standard Pillows: (1) 18 x 18 **Finish Req:** Y
Standard Cushions: Blendown **Standard Finish:**
COM: 10 yards **COL:** N/A
Beech post with Brushed Brass ferrule. Features non-spaced back pillows.

Width: 71 **Depth:** 37 **Height:** 39
AH: 0 **SH:** 20.5 **SD:** 22 **IW:** 71
Weight: 125 lbs **Cube:** 70.78

D	E	F	G	H	J	K COM	L	M	N	O	P	Q	R	S	T	U	(# above U) *	S Nail	M Nail
3585	3612	3639	3666	3693	3720	3747	3774	3801	3828	3855	3882	3909	3936	3963	3990	4017	27 (Riser) + 4017 (U)	N/A	N/A
Leather 1 N/A		Leather 2 N/A		Leather 3 N/A		Leather 4 N/A		Leather 5 N/A		Leather 6 N/A		Leather 8 N/A		COL N/A		S Nail N/A		M Nail N/A	

Fabric SKU: **6311-27** Leather SKU: **N/A**
LIBBY LANGDON FOR FAIRFIELD
Derring Left Arm Facing Chaise

Standard Pillows: (1) 18 x 18 **Finish Req:** Y
Standard Cushions: Blendown **Standard Finish:**
COM: 10 yards **COL:** N/A
Beech post with Brushed Brass ferrule. Features non-spaced back pillows.

Width: 71 **Depth:** 37 **Height:** 39
AH: 0 **SH:** 20.5 **SD:** 22 **IW:** 71
Weight: 125 lbs **Cube:** 70.78

D	E	F	G	H	J	K COM	L	M	N	O	P	Q	R	S	T	U	(# above U) *	S Nail	M Nail
3585	3612	3639	3666	3693	3720	3747	3774	3801	3828	3855	3882	3909	3936	3963	3990	4017	27 (Riser) + 4017 (U)	N/A	N/A
Leather 1 N/A		Leather 2 N/A		Leather 3 N/A		Leather 4 N/A		Leather 5 N/A		Leather 6 N/A		Leather 8 N/A		COL N/A		S Nail N/A		M Nail N/A	

Upholstery

**Pillows are not available on leather SKUs*

Fabric SKU: **6311-50** Leather SKU: **N/A**
LIBBY LANGDON FOR FAIRFIELD
Derring Sofa

Standard Pillows: (2) 18 x 18, (2) 20 x 20 **Finish Req:** Y
Standard Cushions: Blendown **Standard Finish:**
COM: 16 yards **COL:** N/A
Beech post with Brushed Brass ferrule. Features non-spaced back pillows.

Width: 81 **Depth:** 37 **Height:** 39
AH: 24 **SH:** 20.5 **SD:** 22 **IW:** 70
Weight: 162 lbs **Cube:** 79.34

D	E	F	G	H	J	K COM	L	M	N	O	P	Q	R	S	T	U	(# above U) *	S Nail	M Nail
4785	4830	4875	4920	4965	5010	5055	5100	5145	5190	5235	5280	5325	5370	5415	5460	5505	45 (Riser) + 5505 (U)	N/A	N/A
Leather 1 N/A		Leather 2 N/A		Leather 3 N/A		Leather 4 N/A		Leather 5 N/A		Leather 6 N/A		Leather 8 N/A		COL N/A		S Nail N/A		M Nail N/A	

Fabric SKU: **6311-53** Leather SKU: **N/A**
LIBBY LANGDON FOR FAIRFIELD
Derring Right Arm Facing Corner Sofa

Standard Pillows: (2) 18 x 18, (3) 20 x 20 **Finish Req:** Y
Standard Cushions: Blendown **Standard Finish:**
COM: 25.25 yards **COL:** N/A
Beech post with Brushed Brass ferrule. Features non-spaced back pillows.

Width: 111 **Depth:** 37 **Height:** 39
AH: 34 **SH:** 20.5 **SD:** 22 **IW:** 105
Weight: 205 lbs **Cube:** 81.85

D	E	F	G	H	J	K COM	L	M	N	O	P	Q	R	S	T	U	(# above U) *	S Nail	M Nail
6075	6135	6195	6255	6315	6375	6435	6495	6555	6615	6675	6735	6795	6855	6915	6975	7035	60 (Riser) + 7035 (U)	N/A	N/A
Leather 1 N/A		Leather 2 N/A		Leather 3 N/A		Leather 4 N/A		Leather 5 N/A		Leather 6 N/A		Leather 8 N/A		COL N/A		S Nail N/A		M Nail N/A	

Fabric SKU: **6311-54** Leather SKU: **N/A**
LIBBY LANGDON FOR FAIRFIELD
Derring Left Arm Facing Corner Sofa

Standard Pillows: (2) 18 x 18, (3) 20 x 20 **Finish Req:** Y
Standard Cushions: Blendown **Standard Finish:**
COM: 25.25 yards **COL:** N/A
Beech post with Brushed Brass ferrule. Features non-spaced back pillows.

Width: 111 **Depth:** 37 **Height:** 39
AH: 34 **SH:** 20.5 **SD:** 22 **IW:** 105
Weight: 205 lbs **Cube:** 81.85

D	E	F	G	H	J	K COM	L	M	N	O	P	Q	R	S	T	U	(# above U) *	S Nail	M Nail
6075	6135	6195	6255	6315	6375	6435	6495	6555	6615	6675	6735	6795	6855	6915	6975	7035	60 (Riser) + 7035 (U)	N/A	N/A
Leather 1 N/A		Leather 2 N/A		Leather 3 N/A		Leather 4 N/A		Leather 5 N/A		Leather 6 N/A		Leather 8 N/A		COL N/A		S Nail N/A		M Nail N/A	

Fabric SKU: **6311-67** Leather SKU: **N/A**
LIBBY LANGDON FOR FAIRFIELD
Derring Bumper Ottoman

Standard Pillows: N/A **Finish Req:** Y
Standard Cushions: Blendown **Standard Finish:**
COM: 4.75 yards **COL:** N/A
Beech post with Brushed Brass ferrule.

Width: 36 **Depth:** 29 **Height:** 20.5
AH: 0 **SH:** 0 **SD:** 0 **IW:** 0
Weight: 39 lbs **Cube:** 16.92

D	E	F	G	H	J	K COM	L	M	N	O	P	Q	R	S	T	U	(# above U) *	S Nail	M Nail
1650	1662	1674	1686	1698	1710	1722	1734	1746	1758	1770	1782	1794	1806	1818	1830	1842	12 (Riser) + 1842 (U)	N/A	N/A
Leather 1 N/A		Leather 2 N/A		Leather 3 N/A		Leather 4 N/A		Leather 5 N/A		Leather 6 N/A		Leather 8 N/A		COL N/A		S Nail N/A		M Nail N/A	

Fabric SKU: **6311-71** Leather SKU: **N/A**
LIBBY LANGDON FOR FAIRFIELD
Derring Right Arm Facing Loveseat

Standard Pillows: (2) 20 x 20 (1) 18 x 18 **Finish Req:** Y
Standard Cushions: Blendown **Standard Finish:**
COM: 15 yards **COL:** N/A
Beech post with Brushed Brass ferrule. Features non-spaced back pillows.

Width: 76 **Depth:** 37 **Height:** 39
AH: 34 **SH:** 20.5 **SD:** 22 **IW:** 70
Weight: 142 lbs **Cube:** 63.46

D	E	F	G	H	J	K COM	L	M	N	O	P	Q	R	S	T	U	(# above U) *	S Nail	M Nail
4485	4533	4581	4629	4677	4725	4773	4821	4869	4917	4965	5013	5061	5109	5157	5205	5253	48 (Riser) + 5253 (U)	N/A	N/A
Leather 1 N/A		Leather 2 N/A		Leather 3 N/A		Leather 4 N/A		Leather 5 N/A		Leather 6 N/A		Leather 8 N/A		COL N/A		S Nail N/A		M Nail N/A	

Fabric SKU: **6311-72** Leather SKU: **N/A**
LIBBY LANGDON FOR FAIRFIELD
Derring Left Arm Facing Loveseat

Standard Pillows: (2) 20 x 20 (1) 18 x 18 **Finish Req:** Y
Standard Cushions: Blendown **Standard Finish:**
COM: 15 yards **COL:** N/A
Beech post with Brushed Brass ferrule. Features non-spaced back pillows.

Width: 76 **Depth:** 37 **Height:** 39
AH: 34 **SH:** 20.5 **SD:** 22 **IW:** 70
Weight: 142 lbs **Cube:** 63.46

D	E	F	G	H	J	K COM	L	M	N	O	P	Q	R	S	T	U	(# above U) *	S Nail	M Nail
4485	4533	4581	4629	4677	4725	4773	4821	4869	4917	4965	5013	5061	5109	5157	5205	5253	48 (Riser) + 5253 (U)	N/A	N/A
Leather 1 N/A		Leather 2 N/A		Leather 3 N/A		Leather 4 N/A		Leather 5 N/A		Leather 6 N/A		Leather 8 N/A		COL N/A		S Nail N/A		M Nail N/A	

Upholstery

**Pillows are not available on leather SKUs*

Fabric SKU: **6312-50** Leather SKU: **L-6312-50**

LIBBY LANGDON FOR FAIRFIELD

Ryerson Sofa

Standard Pillows: (2) 20 x 20 **Finish Req:** Y

Standard Cushions: Blendown **Standard Finish:**

COM: 15 yards **COL:** 230.35 square feet

Features non-spaced back pillows.

Width: 86.5 **Depth:** 38 **Height:** 30.5

AH: 24.5 **SH:** 20.5 **SD:** 23 **IW:** 76

Weight: 199 lbs **Cube:** 79.34

D	E	F	G	H	J	K COM	L	M	N	O	P	Q	R	S	T	U	(# above U) *	S Nail	M Nail
4950	4992	5034	5076	5118	5160	5202	5244	5286	5328	5370	5412	5454	5496	5538	5580	5622	42 (Riser) + 5622 (U)	N/A	N/A
Leather 1 7800		Leather 2 8145		Leather 3 8490		Leather 4 8835		Leather 5 9180		Leather 6 9525		Leather 8 12690		COL 5286		S Nail N/A		M Nail N/A	

Fabric SKU: **6313-50** Leather SKU: **L-6313-50**

LIBBY LANGDON FOR FAIRFIELD

Barrett Sofa

Standard Pillows: (2) 20 x 20 **Finish Req:** Y

Standard Cushions: Blendown **Standard Finish:**

COM: 16.25 yards **COL:** 220 square feet

Features non-spaced back pillows.

Width: 84.75 **Depth:** 36.5 **Height:** 33

AH: 24.25 **SH:** 20.75 **SD:** 21 **IW:** 74

Weight: 169 lbs **Cube:** 79.34

D	E	F	G	H	J	K COM	L	M	N	O	P	Q	R	S	T	U	(# above U) *	S Nail	M Nail
4875	4920	4965	5010	5055	5100	5145	5190	5235	5280	5325	5370	5415	5460	5505	5550	5595	45 (Riser) + 5595 (U)	90	105
Leather 1 7845		Leather 2 8250		Leather 3 8655		Leather 4 9060		Leather 5 9465		Leather 6 9870		Leather 8 13545		COL 5235		S Nail 90		M Nail 105	

Fabric SKU: **6324-04** Leather SKU: **L-6324-04**

LIBBY LANGDON FOR FAIRFIELD

Boyd Dining Chair

Standard Pillows: N/A **Finish Req:** Y

Standard Cushions: High Resiliency 40 **Standard Finish:**

COM: 2.25 yards **COL:** 45 square feet

Width: 22 **Depth:** 24.5 **Height:** 32

AH: 0 **SH:** 19 **SD:** 20 **IW:** 22

Weight: 19 lbs **Cube:** 9.98

D	E	F	G	H	J	K COM	L	M	N	O	P	Q	R	S	T	U	(# above U) *	S Nail	M Nail
1485	1494	1503	1512	1521	1530	1539	1548	1557	1566	1575	1584	1593	1602	1611	1620	1629	9 (Riser) + 1629 (U)	N/A	N/A
Leather 1 2130		Leather 2 2205		Leather 3 2280		Leather 4 2355		Leather 5 2430		Leather 6 2505		Leather 8 3135		COL 1557		S Nail N/A		M Nail N/A	

Fabric SKU: **6327-01-2** Leather SKU: **N/A**

LIBBY LANGDON FOR FAIRFIELD

Cabott Lounge Chair

Nickel Legs

Standard Pillows: N/A **Finish Req:** N

Standard Cushions: High Resiliency 40 **Standard Finish:** Nickel

COM: 4.75 yards **COL:** N/A

Features Nickel Metal Legs.

Width: 33 **Depth:** 29.75 **Height:** 32.25

AH: 24 **SH:** 18.75 **SD:** 20.5 **IW:** 22

Weight: 40 lbs **Cube:** 18.32

D	E	F	G	H	J	K COM	L	M	N	O	P	Q	R	S	T	U	(# above U) *	S Nail	M Nail
2625	2640	2655	2670	2685	2700	2715	2730	2745	2760	2775	2790	2805	2820	2835	2850	2865	15 (Riser) + 2865 (U)	60	N/A
Leather 1 N/A		Leather 2 N/A		Leather 3 N/A		Leather 4 N/A		Leather 5 N/A		Leather 6 N/A		Leather 8 N/A		COL N/A		S Nail N/A		M Nail N/A	

Fabric SKU: **6327-01-6** Leather SKU: **N/A**

LIBBY LANGDON FOR FAIRFIELD

Cabott Lounge Chair

Brushed Brass Legs

Standard Pillows: N/A **Finish Req:** N

Standard Cushions: High Resiliency 40 **Standard Finish:** Brushed Brass

COM: 4.75 yards **COL:** N/A

Features Brushed Brass Metal Legs.

Width: 33 **Depth:** 29.75 **Height:** 32.25

AH: 24 **SH:** 18.75 **SD:** 20.5 **IW:** 22

Weight: 40 lbs **Cube:** 18.32

D	E	F	G	H	J	K COM	L	M	N	O	P	Q	R	S	T	U	(# above U) *	S Nail	M Nail
2625	2640	2655	2670	2685	2700	2715	2730	2745	2760	2775	2790	2805	2820	2835	2850	2865	15 (Riser) + 2865 (U)	60	N/A
Leather 1 N/A		Leather 2 N/A		Leather 3 N/A		Leather 4 N/A		Leather 5 N/A		Leather 6 N/A		Leather 8 N/A		COL N/A		S Nail N/A		M Nail N/A	

Fabric SKU: **6327-31** Leather SKU: **N/A**

LIBBY LANGDON FOR FAIRFIELD

Cabott Swivel Chair

Standard Pillows: N/A **Finish Req:** N

Standard Cushions: High Resiliency 40 **Standard Finish:**

COM: 5.25 yards **COL:** N/A

Width: 33 **Depth:** 29.75 **Height:** 32.25

AH: 24 **SH:** 18.75 **SD:** 20.5 **IW:** 22

Weight: 40 lbs **Cube:** 18.32

D	E	F	G	H	J	K COM	L	M	N	O	P	Q	R	S	T	U	(# above U) *	S Nail	M Nail
2250	2265	2280	2295	2310	2325	2340	2355	2370	2385	2400	2415	2430	2445	2460	2475	2490	15 (Riser) + 2490 (U)	60	N/A
Leather 1 N/A		Leather 2 N/A		Leather 3 N/A		Leather 4 N/A		Leather 5 N/A		Leather 6 N/A		Leather 8 N/A		COL N/A		S Nail N/A		M Nail N/A	

Upholstery

**Pillows are not available on leather SKUs*

Fabric SKU: **6328-01** Leather SKU: **N/A**
 LIBBY LANGDON FOR FAIRFIELD
Corwin Lounge Chair

Standard Pillows: N/A **Finish Req:** Y
Standard Cushions: Classic Plush **Standard Finish:**
COM: 5.25 yards **COL:** N/A

Width: 32.5 **Depth:** 25.5 **Height:** 32.5
AH: 24 **SH:** 20 **SD:** 24 **IW:** 22
Weight: 52 lbs **Cube:** 15.58

D	E	F	G	H	J	K COM	L	M	N	O	P	Q	R	S	T	U	(# above U) *	S Nail	M Nail
2385	2400	2415	2430	2445	2460	2475	2490	2505	2520	2535	2550	2565	2580	2595	2610	2625	15 (Riser) + 2625 (U)	N/A	N/A
Leather 1 N/A		Leather 2 N/A		Leather 3 N/A		Leather 4 N/A		Leather 5 N/A		Leather 6 N/A		Leather 8 N/A		COL N/A		S Nail N/A		M Nail N/A	

Fabric SKU: **6329-01** Leather SKU: **N/A**
 LIBBY LANGDON FOR FAIRFIELD
Francis Lounge Chair

Standard Pillows: N/A **Finish Req:** N
Standard Cushions: Blendown **Standard Finish:**
COM: 7.5 yards **COL:** N/A

Width: 40 **Depth:** 40.5 **Height:** 35
AH: 25.5 **SH:** 19.25 **SD:** 23 **IW:** 24.25
Weight: 85 lbs **Cube:** 32.81

D	E	F	G	H	J	K COM	L	M	N	O	P	Q	R	S	T	U	(# above U) *	S Nail	M Nail
2475	2499	2523	2547	2571	2595	2619	2643	2667	2691	2715	2739	2763	2787	2811	2835	2859	24 (Riser) + 2859 (U)	N/A	N/A
Leather 1 N/A		Leather 2 N/A		Leather 3 N/A		Leather 4 N/A		Leather 5 N/A		Leather 6 N/A		Leather 8 N/A		COL N/A		S Nail N/A		M Nail N/A	

Fabric SKU: **6329-20** Leather SKU: **N/A**
 LIBBY LANGDON FOR FAIRFIELD
Francis Ottoman

Standard Pillows: N/A **Finish Req:** N
Standard Cushions: Blendown **Standard Finish:**
COM: 3.75 yards **COL:** N/A

Width: 37.25 **Depth:** 22 **Height:** 18.25
AH: 0 **SH:** 18.25 **SD:** 22 **IW:** 37
Weight: 30 lbs **Cube:** 8.65

D	E	F	G	H	J	K COM	L	M	N	O	P	Q	R	S	T	U	(# above U) *	S Nail	M Nail
987	1002	1017	1032	1047	1062	1077	1092	1107	1122	1137	1152	1167	1182	1197	1212	1227	15 (Riser) + 1227 (U)	N/A	N/A
Leather 1 N/A		Leather 2 N/A		Leather 3 N/A		Leather 4 N/A		Leather 5 N/A		Leather 6 N/A		Leather 8 N/A		COL N/A		S Nail N/A		M Nail N/A	

Fabric SKU: **6329-23** Leather SKU: **N/A**
 LIBBY LANGDON FOR FAIRFIELD
Francis Upholstered Table Ottoman

Standard Pillows: N/A **Finish Req:** Y
Standard Cushions: Blendown **Standard Finish:**
COM: 2.25 yards **COL:** N/A

Width: 16.5 **Depth:** 40.5 **Height:** 22
AH: 0 **SH:** 17.25 **SD:** 0 **IW:** 0
Weight: 75 lbs **Cube:** 8.5

D	E	F	G	H	J	K COM	L	M	N	O	P	Q	R	S	T	U	(# above U) *	S Nail	M Nail
1197	1206	1215	1224	1233	1242	1251	1260	1269	1278	1287	1296	1305	1314	1323	1332	1341	9 (Riser) + 1341 (U)	N/A	N/A
Leather 1 N/A		Leather 2 N/A		Leather 3 N/A		Leather 4 N/A		Leather 5 N/A		Leather 6 N/A		Leather 8 N/A		COL N/A		S Nail N/A		M Nail N/A	

Fabric SKU: **6329-29** Leather SKU: **N/A**
 LIBBY LANGDON FOR FAIRFIELD
Francis Corner Chair
 Two Backs over One Seat

Standard Pillows: (1) 18x18, (1) 20x20 weltless **Finish Req:** N
Standard Cushions: Blendown **Standard Finish:**
COM: 10.5 yards **COL:** N/A

Width: 40.5 **Depth:** 40.5 **Height:** 34.25
AH: 0 **SH:** 19.25 **SD:** 23 **IW:** 22
Weight: 80 lbs **Cube:** 79.34

D	E	F	G	H	J	K COM	L	M	N	O	P	Q	R	S	T	U	(# above U) *	S Nail	M Nail
2685	2718	2751	2784	2817	2850	2883	2916	2949	2982	3015	3048	3081	3114	3147	3180	3213	33 (Riser) + 3213 (U)	N/A	N/A
Leather 1 N/A		Leather 2 N/A		Leather 3 N/A		Leather 4 N/A		Leather 5 N/A		Leather 6 N/A		Leather 8 N/A		COL N/A		S Nail N/A		M Nail N/A	

Fabric SKU: **6329-50** Leather SKU: **N/A**
 LIBBY LANGDON FOR FAIRFIELD
Francis Sofa
 Two boxed backs over two seats

Standard Pillows: (2) 18x18, (2) 20x20 **Finish Req:** N
Standard Cushions: Blendown **Standard Finish:**
COM: 19 yards **COL:** N/A

Width: 97 **Depth:** 40.25 **Height:** 35
AH: 25.75 **SH:** 19.25 **SD:** 23 **IW:** 79.75
Weight: 150 lbs **Cube:** 79.07

D	E	F	G	H	J	K COM	L	M	N	O	P	Q	R	S	T	U	(# above U) *	S Nail	M Nail
4785	4836	4887	4938	4989	5040	5091	5142	5193	5244	5295	5346	5397	5448	5499	5550	5601	51 (Riser) + 5601 (U)	N/A	N/A
Leather 1 N/A		Leather 2 N/A		Leather 3 N/A		Leather 4 N/A		Leather 5 N/A		Leather 6 N/A		Leather 8 N/A		COL N/A		S Nail N/A		M Nail N/A	

Upholstery

**Pillows are not available on leather SKUs*

Fabric SKU: **6329-51** Leather SKU: **N/A**

LIBBY LANGDON FOR FAIRFIELD

Francis Right Arm Sofa

Two Backs over Two Seats

Width: 89 **Depth:** 40.5 **Height:** 35

AH: 25.75 **SH:** 19.25 **SD:** 23 **IW:** 79.75

Weight: 155 lbs **Cube:** 73

Standard Pillows: (1) 18x18, (1) 20x20 weltless **Finish Req:** N

Standard Cushions: Blendown **Standard Finish:**

COM: 16.5 yards **COL:** N/A

D	E	F	G	H	J	K COM	L	M	N	O	P	Q	R	S	T	U	(# above U) *	S Nail	M Nail
4125	4173	4221	4269	4317	4365	4413	4461	4509	4557	4605	4653	4701	4749	4797	4845	4893	48 (Riser) + 4893 (U)	N/A	N/A
Leather 1 N/A		Leather 2 N/A		Leather 3 N/A		Leather 4 N/A		Leather 5 N/A		Leather 6 N/A		Leather 8 N/A		COL N/A		S Nail N/A		M Nail N/A	

Fabric SKU: **6329-52** Leather SKU: **N/A**

LIBBY LANGDON FOR FAIRFIELD

Francis Left Arm Sofa

Two Backs over Two Seats

Width: 89 **Depth:** 40.5 **Height:** 35

AH: 25.75 **SH:** 19.25 **SD:** 23 **IW:** 79.75

Weight: 155 lbs **Cube:** 92.4

Standard Pillows: (1) 18x18, (1) 20x20 weltless **Finish Req:** N

Standard Cushions: Blendown **Standard Finish:**

COM: 16.5 yards **COL:** N/A

D	E	F	G	H	J	K COM	L	M	N	O	P	Q	R	S	T	U	(# above U) *	S Nail	M Nail
4125	4173	4221	4269	4317	4365	4413	4461	4509	4557	4605	4653	4701	4749	4797	4845	4893	48 (Riser) + 4893 (U)	N/A	N/A
Leather 1 N/A		Leather 2 N/A		Leather 3 N/A		Leather 4 N/A		Leather 5 N/A		Leather 6 N/A		Leather 8 N/A		COL N/A		S Nail N/A		M Nail N/A	

Fabric SKU: **6329-53** Leather SKU: **N/A**

LIBBY LANGDON FOR FAIRFIELD

Francis Right Arm Corner Sofa

Four Backs over Three Seats

Width: 128.25 **Depth:** 40.5 **Height:** 35

AH: 25.75 **SH:** 19.25 **SD:** 23 **IW:** 80.5

Weight: 225 lbs **Cube:** 105.2

Standard Pillows: (2) 18x18, (2) 20x20 weltless **Finish Req:** N

Standard Cushions: Blendown **Standard Finish:**

COM: 25.75 yards **COL:** N/A

D	E	F	G	H	J	K COM	L	M	N	O	P	Q	R	S	T	U	(# above U) *	S Nail	M Nail
5625	5700	5775	5850	5925	6000	6075	6150	6225	6300	6375	6450	6525	6600	6675	6750	6825	75 (Riser) + 6825 (U)	N/A	N/A
Leather 1 N/A		Leather 2 N/A		Leather 3 N/A		Leather 4 N/A		Leather 5 N/A		Leather 6 N/A		Leather 8 N/A		COL N/A		S Nail N/A		M Nail N/A	

Fabric SKU: **6329-54** Leather SKU: **N/A**

LIBBY LANGDON FOR FAIRFIELD

Francis Left Arm Corner Sofa

Four Backs over Three Seats

Width: 128.25 **Depth:** 40.5 **Height:** 35

AH: 25.75 **SH:** 19.25 **SD:** 23 **IW:** 80.5

Weight: 225 lbs **Cube:** 105.2

Standard Pillows: (2) 18x18, (2) 20x20 weltless **Finish Req:** N

Standard Cushions: Blendown **Standard Finish:**

COM: 25.75 yards **COL:** N/A

D	E	F	G	H	J	K COM	L	M	N	O	P	Q	R	S	T	U	(# above U) *	S Nail	M Nail
5625	5700	5775	5850	5925	6000	6075	6150	6225	6300	6375	6450	6525	6600	6675	6750	6825	75 (Riser) + 6825 (U)	N/A	N/A
Leather 1 N/A		Leather 2 N/A		Leather 3 N/A		Leather 4 N/A		Leather 5 N/A		Leather 6 N/A		Leather 8 N/A		COL N/A		S Nail N/A		M Nail N/A	

Fabric SKU: **6329-67** Leather SKU: **N/A**

LIBBY LANGDON FOR FAIRFIELD

Francis Bumper Ottoman

Width: 40.25 **Depth:** 40.25 **Height:** 19.25

AH: 0 **SH:** 19.25 **SD:** 40.25 **IW:** 40.25

Weight: 52 lbs **Cube:** 18.04

Standard Pillows: N/A **Finish Req:** N

Standard Cushions: Blendown **Standard Finish:**

COM: 5.5 yards **COL:** N/A

D	E	F	G	H	J	K COM	L	M	N	O	P	Q	R	S	T	U	(# above U) *	S Nail	M Nail
1575	1593	1611	1629	1647	1665	1683	1701	1719	1737	1755	1773	1791	1809	1827	1845	1863	18 (Riser) + 1863 (U)	N/A	N/A
Leather 1 N/A		Leather 2 N/A		Leather 3 N/A		Leather 4 N/A		Leather 5 N/A		Leather 6 N/A		Leather 8 N/A		COL N/A		S Nail N/A		M Nail N/A	

Fabric SKU: **6329-71** Leather SKU: **N/A**

LIBBY LANGDON FOR FAIRFIELD

Francis Right Arm Loveseat

One Back over One Seat

Width: 59.5 **Depth:** 40.25 **Height:** 35

AH: 25.75 **SH:** 19.25 **SD:** 23 **IW:** 51

Weight: 120 lbs **Cube:** 61.76

Standard Pillows: (1) 18x18, (1) 20x20 weltless **Finish Req:** N

Standard Cushions: Blendown **Standard Finish:**

COM: 10.75 yards **COL:** N/A

D	E	F	G	H	J	K COM	L	M	N	O	P	Q	R	S	T	U	(# above U) *	S Nail	M Nail
3150	3183	3216	3249	3282	3315	3348	3381	3414	3447	3480	3513	3546	3579	3612	3645	3678	33 (Riser) + 3678 (U)	N/A	N/A
Leather 1 N/A		Leather 2 N/A		Leather 3 N/A		Leather 4 N/A		Leather 5 N/A		Leather 6 N/A		Leather 8 N/A		COL N/A		S Nail N/A		M Nail N/A	

Upholstery

**Pillows are not available on leather SKUs*

Fabric SKU: **6329-72** Leather SKU: **N/A**
 LIBBY LANGDON FOR FAIRFIELD
Francis Left Arm Loveseat
 One Back over One Seat
Width: 59.5 Depth: 40.25 Height: 35
AH: 25.75 SH: 19.25 SD: 23 IW: 51
Weight: 120 lbs Cube: 48.5

Standard Pillows: (1) 18x18, (1) 20x20 weltless **Finish Req:** N
Standard Cushions: Blendown **Standard Finish:**
COM: 10.75 yards **COL:** N/A

D	E	F	G	H	J	K COM	L	M	N	O	P	Q	R	S	T	U	(# above U) *	S Nail	M Nail
3150	3183	3216	3249	3282	3315	3348	3381	3414	3447	3480	3513	3546	3579	3612	3645	3678	33 (Riser) + 3678 (U)	N/A	N/A
Leather 1 N/A		Leather 2 N/A		Leather 3 N/A		Leather 4 N/A		Leather 5 N/A		Leather 6 N/A		Leather 8 N/A		COL N/A		S Nail N/A		M Nail N/A	

Fabric SKU: **6329-78** Leather SKU: **N/A**
 LIBBY LANGDON FOR FAIRFIELD
Francis Armless Sectional Chair
 One Back over One Seat
Width: 40.25 Depth: 40.25 Height: 35
AH: 0 SH: 19.25 SD: 23 IW: 40.25
Weight: 80 lbs Cube: 32.81

Standard Pillows: N/A **Finish Req:** N
Standard Cushions: Blendown **Standard Finish:**
COM: 8.25 yards **COL:** N/A

D	E	F	G	H	J	K COM	L	M	N	O	P	Q	R	S	T	U	(# above U) *	S Nail	M Nail
2175	2202	2229	2256	2283	2310	2337	2364	2391	2418	2445	2472	2499	2526	2553	2580	2607	27 (Riser) + 2607 (U)	N/A	N/A
Leather 1 N/A		Leather 2 N/A		Leather 3 N/A		Leather 4 N/A		Leather 5 N/A		Leather 6 N/A		Leather 8 N/A		COL N/A		S Nail N/A		M Nail N/A	

Fabric SKU: **6339-50** Leather SKU: **N/A**
 LIBBY LANGDON FOR FAIRFIELD
Francis Sofa
 Two boxed backs over one seat
Width: 97 Depth: 40.25 Height: 35
AH: 25.75 SH: 19.25 SD: 23 IW: 79.75
Weight: 150 lbs Cube: 79.07

Standard Pillows: (2) 18x18, (2) 20x20 **Finish Req:** N
Standard Cushions: Blendown **Standard Finish:**
COM: 18.25 yards **COL:** N/A

D	E	F	G	H	J	K COM	L	M	N	O	P	Q	R	S	T	U	(# above U) *	S Nail	M Nail
4785	4836	4887	4938	4989	5040	5091	5142	5193	5244	5295	5346	5397	5448	5499	5550	5601	51 (Riser) + 5601 (U)	N/A	N/A
Leather 1 N/A		Leather 2 N/A		Leather 3 N/A		Leather 4 N/A		Leather 5 N/A		Leather 6 N/A		Leather 8 N/A		COL N/A		S Nail N/A		M Nail N/A	

Fabric SKU: **6339-51** Leather SKU: **N/A**
 LIBBY LANGDON FOR FAIRFIELD
Francis Right Arm Sofa
 Two Backs over One Seat
Width: 89 Depth: 40.5 Height: 35
AH: 25.75 SH: 19.25 SD: 23 IW: 80.5
Weight: 155 lbs Cube: 92.4

Standard Pillows: (1) 18x18, (1) 20x20 weltless **Finish Req:** N
Standard Cushions: Blendown **Standard Finish:**
COM: 16 yards **COL:** N/A

D	E	F	G	H	J	K COM	L	M	N	O	P	Q	R	S	T	U	(# above U) *	S Nail	M Nail
4125	4173	4221	4269	4317	4365	4413	4461	4509	4557	4605	4653	4701	4749	4797	4845	4893	48 (Riser) + 4893 (U)	N/A	N/A
Leather 1 N/A		Leather 2 N/A		Leather 3 N/A		Leather 4 N/A		Leather 5 N/A		Leather 6 N/A		Leather 8 N/A		COL N/A		S Nail N/A		M Nail N/A	

Fabric SKU: **6339-52** Leather SKU: **N/A**
 LIBBY LANGDON FOR FAIRFIELD
Francis Left Arm Sofa
 Two Backs over One Seat
Width: 89 Depth: 40.5 Height: 35
AH: 25.75 SH: 19.25 SD: 23 IW: 80.5
Weight: 155 lbs Cube: 73

Standard Pillows: (1) 18x18, (1) 20x20 weltless **Finish Req:** N
Standard Cushions: Blendown **Standard Finish:**
COM: 16 yards **COL:** N/A

D	E	F	G	H	J	K COM	L	M	N	O	P	Q	R	S	T	U	(# above U) *	S Nail	M Nail
4125	4173	4221	4269	4317	4365	4413	4461	4509	4557	4605	4653	4701	4749	4797	4845	4893	48 (Riser) + 4893 (U)	N/A	N/A
Leather 1 N/A		Leather 2 N/A		Leather 3 N/A		Leather 4 N/A		Leather 5 N/A		Leather 6 N/A		Leather 8 N/A		COL N/A		S Nail N/A		M Nail N/A	

Fabric SKU: **6339-53** Leather SKU: **N/A**
 LIBBY LANGDON FOR FAIRFIELD
Francis Right Arm Corner Sofa
 Four Backs over One Seat
Width: 128.25 Depth: 40.5 Height: 35
AH: 25.75 SH: 19.25 SD: 23 IW: 80.5
Weight: 225 lbs Cube: 105.2

Standard Pillows: (2) 18x18, (2) 20x20 weltless **Finish Req:** N
Standard Cushions: Blendown **Standard Finish:**
COM: 25.75 yards **COL:** N/A

D	E	F	G	H	J	K COM	L	M	N	O	P	Q	R	S	T	U	(# above U) *	S Nail	M Nail
5625	5700	5775	5850	5925	6000	6075	6150	6225	6300	6375	6450	6525	6600	6675	6750	6825	75 (Riser) + 6825 (U)	N/A	N/A
Leather 1 N/A		Leather 2 N/A		Leather 3 N/A		Leather 4 N/A		Leather 5 N/A		Leather 6 N/A		Leather 8 N/A		COL N/A		S Nail N/A		M Nail N/A	

Upholstery

**Pillows are not available on leather SKUs*

Fabric SKU: **6339-54** Leather SKU: **N/A**
 LIBBY LANGDON FOR FAIRFIELD
Francis Left Arm Corner Sofa
 Four Backs over One Seat
Width: 128.25 **Depth:** 40.5 **Height:** 35
AH: 25.75 **SH:** 19.25 **SD:** 23 **IW:** 80.5
Weight: 225 lbs **Cube:** 105.2

Standard Pillows: (2) 18x18, (2) 20x20 weltless **Finish Req:** N
Standard Cushions: Blendown **Standard Finish:**
COM: 25.75 yards **COL:** N/A

D	E	F	G	H	J	K COM	L	M	N	O	P	Q	R	S	T	U	(# above U) *	S Nail	M Nail
5625	5700	5775	5850	5925	6000	6075	6150	6225	6300	6375	6450	6525	6600	6675	6750	6825	75 (Riser) + 6825 (U)	N/A	N/A
Leather 1 N/A		Leather 2 N/A		Leather 3 N/A		Leather 4 N/A		Leather 5 N/A		Leather 6 N/A		Leather 8 N/A		COL N/A		S Nail N/A		M Nail N/A	

Fabric SKU: **6345-04** Leather SKU: **N/A**
 LIBBY LANGDON FOR FAIRFIELD
Cambridge Arm Chair

Standard Pillows: N/A **Finish Req:** Y
Standard Cushions: High Resiliency 40 **Standard Finish:**
COM: 3.25 yards **COL:** N/A

Width: 24 **Depth:** 26 **Height:** 37
AH: 25.5 **SH:** 19 **SD:** 19 **IW:** 19.75
Weight: 34 lbs **Cube:** 13.36

D	E	F	G	H	J	K COM	L	M	N	O	P	Q	R	S	T	U	(# above U) *	S Nail	M Nail
1575	1587	1599	1611	1623	1635	1647	1659	1671	1683	1695	1707	1719	1731	1743	1755	1767	12 (Riser) + 1767 (U)	60	N/A
Leather 1 N/A		Leather 2 N/A		Leather 3 N/A		Leather 4 N/A		Leather 5 N/A		Leather 6 N/A		Leather 8 N/A		COL N/A		S Nail N/A		M Nail N/A	

Fabric SKU: **6345-05** Leather SKU: **N/A**
 LIBBY LANGDON FOR FAIRFIELD
Cambridge Side Chair

Standard Pillows: N/A **Finish Req:** Y
Standard Cushions: High Resiliency 40 **Standard Finish:**
COM: 3.25 yards **COL:** N/A

Width: 22.75 **Depth:** 26 **Height:** 37
AH: 0 **SH:** 19 **SD:** 19 **IW:** 19.75
Weight: 25 lbs **Cube:** 12.66

D	E	F	G	H	J	K COM	L	M	N	O	P	Q	R	S	T	U	(# above U) *	S Nail	M Nail
1485	1497	1509	1521	1533	1545	1557	1569	1581	1593	1605	1617	1629	1641	1653	1665	1677	12 (Riser) + 1677 (U)	60	N/A
Leather 1 N/A		Leather 2 N/A		Leather 3 N/A		Leather 4 N/A		Leather 5 N/A		Leather 6 N/A		Leather 8 N/A		COL N/A		S Nail N/A		M Nail N/A	

Fabric SKU: **6400-01** Leather SKU: **L-6400-01**
 LIBBY LANGDON FOR FAIRFIELD
Rosewood Lounge Chair

Standard Pillows: N/A **Finish Req:** Y
Standard Cushions: Blendown **Standard Finish:**
COM: 5.5 yards **COL:** 96 square feet

Width: 28.5 **Depth:** 36 **Height:** 32.5
AH: 24 **SH:** 20 **SD:** 21.5 **IW:** 19.5
Weight: 56 lbs **Cube:** 29.69

D	E	F	G	H	J	K COM	L	M	N	O	P	Q	R	S	T	U	(# above U) *	S Nail	M Nail
2670	2685	2700	2715	2730	2745	2760	2775	2790	2805	2820	2835	2850	2865	2880	2895	2910	15 (Riser) + 2910 (U)	45	60
Leather 1 3960		Leather 2 4110		Leather 3 4260		Leather 4 4410		Leather 5 4560		Leather 6 4710		Leather 8 6030		COL 2790		S Nail 45		M Nail 60	

Fabric SKU: **6400-20** Leather SKU: **L-6400-20**
 LIBBY LANGDON FOR FAIRFIELD
Rosewood Ottoman

Standard Pillows: N/A **Finish Req:** Y
Standard Cushions: High Resiliency 30 **Standard Finish:**
COM: 2.25 yards **COL:** 40 square feet

Width: 25 **Depth:** 21 **Height:** 17.5
AH: 0 **SH:** 0 **SD:** 0 **IW:** 0
Weight: 15 lbs **Cube:** 10.77

D	E	F	G	H	J	K COM	L	M	N	O	P	Q	R	S	T	U	(# above U) *	S Nail	M Nail
1245	1254	1263	1272	1281	1290	1299	1308	1317	1326	1335	1344	1353	1362	1371	1380	1389	9 (Riser) + 1389 (U)	30	45
Leather 1 1815		Leather 2 1875		Leather 3 1935		Leather 4 1995		Leather 5 2055		Leather 6 2115		Leather 8 2670		COL 1317		S Nail 30		M Nail 45	

Fabric SKU: **6403-01-2** Leather SKU: **L-6403-01-2**
 LIBBY LANGDON FOR FAIRFIELD
Westway Lounge Chair

Standard Pillows: N/A **Finish Req:** N
Standard Cushions: Blendown **Standard Finish:** Nickel
COM: 6.5 yards **COL:** 107 square feet

Width: 32 **Depth:** 36.5 **Height:** 34.5
AH: 23.25 **SH:** 20 **SD:** 22 **IW:** 22
Weight: 63 lbs **Cube:** 36.49

D	E	F	G	H	J	K COM	L	M	N	O	P	Q	R	S	T	U	(# above U) *	S Nail	M Nail
2595	2613	2631	2649	2667	2685	2703	2721	2739	2757	2775	2793	2811	2829	2847	2865	2883	18 (Riser) + 2883 (U)	120	135
Leather 1 4140		Leather 2 4305		Leather 3 4470		Leather 4 4635		Leather 5 4800		Leather 6 4965		Leather 8 6435		COL 2739		S Nail 120		M Nail 135	

Upholstery

**Pillows are not available on leather SKUs*

Fabric SKU: **6403-01-6** Leather SKU: **L-6403-01-6**

LIBBY LANGDON FOR FAIRFIELD

Westway Lounge Chair

Standard Pillows: N/A **Finish Req:** N

Standard Cushions: Blendown **Standard Finish:** Brushed Brass

COM: 6.5 yards **COL:** 107 square feet

Width: 32 **Depth:** 36.5 **Height:** 34.5

AH: 23.25 **SH:** 20 **SD:** 22 **IW:** 22

Weight: 63 lbs **Cube:** 36.49

D	E	F	G	H	J	K COM	L	M	N	O	P	Q	R	S	T	U	(# above U) *	S Nail	M Nail
2595	2613	2631	2649	2667	2685	2703	2721	2739	2757	2775	2793	2811	2829	2847	2865	2883	18 (Riser) + 2883 (U)	120	135
Leather 1		Leather 2		Leather 3		Leather 4		Leather 5		Leather 6		Leather 8		COL		S Nail		M Nail	
4140		4305		4470		4635		4800		4965		6435		2739		120		135	

Fabric SKU: **6403-20-2** Leather SKU: **N/A**

LIBBY LANGDON FOR FAIRFIELD

Westway Ottoman

Standard Pillows: N/A **Finish Req:** N

Standard Cushions: High Resiliency 30 **Standard Finish:** Nickel

COM: 2.75 yards **COL:** N/A

Width: 26 **Depth:** 20 **Height:** 18

AH: 0 **SH:** 0 **SD:** 0 **IW:** 0

Weight: 30 lbs **Cube:** 5.41

D	E	F	G	H	J	K COM	L	M	N	O	P	Q	R	S	T	U	(# above U) *	S Nail	M Nail
1185	1197	1209	1221	1233	1245	1257	1269	1281	1293	1305	1317	1329	1341	1353	1365	1377	12 (Riser) + 1377 (U)	30	45
Leather 1		Leather 2		Leather 3		Leather 4		Leather 5		Leather 6		Leather 8		COL		S Nail		M Nail	
N/A		N/A		N/A		N/A		N/A		N/A		N/A		N/A		N/A		N/A	

Fabric SKU: **6403-20-6** Leather SKU: **N/A**

LIBBY LANGDON FOR FAIRFIELD

Westway Ottoman

Standard Pillows: N/A **Finish Req:** N

Standard Cushions: High Resiliency 30 **Standard Finish:** Brushed Brass

COM: 2.75 yards **COL:** N/A

Width: 26 **Depth:** 20 **Height:** 18

AH: 0 **SH:** 0 **SD:** 0 **IW:** 0

Weight: 30 lbs **Cube:** 5.41

D	E	F	G	H	J	K COM	L	M	N	O	P	Q	R	S	T	U	(# above U) *	S Nail	M Nail
1185	1197	1209	1221	1233	1245	1257	1269	1281	1293	1305	1317	1329	1341	1353	1365	1377	12 (Riser) + 1377 (U)	30	45
Leather 1		Leather 2		Leather 3		Leather 4		Leather 5		Leather 6		Leather 8		COL		S Nail		M Nail	
N/A		N/A		N/A		N/A		N/A		N/A		N/A		N/A		N/A		N/A	

Fabric SKU: **6403-26-2** Leather SKU: **N/A**

LIBBY LANGDON FOR FAIRFIELD

Westway Right Arm Facing Chaise

Standard Pillows: (1) 20 x 20 **Finish Req:** N

Standard Cushions: Blendown **Standard Finish:** Nickel

COM: 10.5 yards **COL:** N/A

Width: 33 **Depth:** 66 **Height:** 34.5

AH: 23.25 **SH:** 20 **SD:** 53.5 **IW:** 28.5

Weight: 87 lbs **Cube:** 43.48

D	E	F	G	H	J	K COM	L	M	N	O	P	Q	R	S	T	U	(# above U) *	S Nail	M Nail
3795	3828	3861	3894	3927	3960	3993	4026	4059	4092	4125	4158	4191	4224	4257	4290	4323	33 (Riser) + 4323 (U)	90	105
Leather 1		Leather 2		Leather 3		Leather 4		Leather 5		Leather 6		Leather 8		COL		S Nail		M Nail	
N/A		N/A		N/A		N/A		N/A		N/A		N/A		N/A		N/A		N/A	

Fabric SKU: **6403-26-6** Leather SKU: **N/A**

LIBBY LANGDON FOR FAIRFIELD

Westway Right Arm Facing Chaise

Standard Pillows: (1) 20 x 20 **Finish Req:** N

Standard Cushions: Blendown **Standard Finish:** Brushed Brass

COM: 10.5 yards **COL:** N/A

Width: 33 **Depth:** 66 **Height:** 34.5

AH: 23.25 **SH:** 20 **SD:** 53.5 **IW:** 28.5

Weight: 87 lbs **Cube:** 43.48

D	E	F	G	H	J	K COM	L	M	N	O	P	Q	R	S	T	U	(# above U) *	S Nail	M Nail
3795	3828	3861	3894	3927	3960	3993	4026	4059	4092	4125	4158	4191	4224	4257	4290	4323	33 (Riser) + 4323 (U)	90	105
Leather 1		Leather 2		Leather 3		Leather 4		Leather 5		Leather 6		Leather 8		COL		S Nail		M Nail	
N/A		N/A		N/A		N/A		N/A		N/A		N/A		N/A		N/A		N/A	

Fabric SKU: **6403-27-2** Leather SKU: **N/A**

LIBBY LANGDON FOR FAIRFIELD

Westway Left Arm Facing Chaise

Standard Pillows: (1) 20 x 20 **Finish Req:** N

Standard Cushions: Blendown **Standard Finish:** Nickel

COM: 10.5 yards **COL:** N/A

Width: 33 **Depth:** 66 **Height:** 34.5

AH: 23.25 **SH:** 20 **SD:** 53.5 **IW:** 28.5

Weight: 87 lbs **Cube:** 55.51

D	E	F	G	H	J	K COM	L	M	N	O	P	Q	R	S	T	U	(# above U) *	S Nail	M Nail
3795	3828	3861	3894	3927	3960	3993	4026	4059	4092	4125	4158	4191	4224	4257	4290	4323	33 (Riser) + 4323 (U)	90	105
Leather 1		Leather 2		Leather 3		Leather 4		Leather 5		Leather 6		Leather 8		COL		S Nail		M Nail	
N/A		N/A		N/A		N/A		N/A		N/A		N/A		N/A		N/A		N/A	

Upholstery

**Pillows are not available on leather SKUs*

Fabric SKU: **6403-27-6** Leather SKU: **N/A**

LIBBY LANGDON FOR FAIRFIELD

Westway Left Arm Facing Chaise

Standard Pillows: (1) 20 x 20 **Finish Req:** N

Standard Cushions: Blendown **Standard Finish:** Brushed Brass

COM: 10.5 yards **COL:** N/A

Width: 33 **Depth:** 66 **Height:** 34.5
AH: 23.25 **SH:** 20 **SD:** 53.5 **IW:** 28.5
Weight: 87 lbs **Cube:** 43.48

D	E	F	G	H	J	K COM	L	M	N	O	P	Q	R	S	T	U	(# above U) *	S Nail	M Nail
3795	3828	3861	3894	3927	3960	3993	4026	4059	4092	4125	4158	4191	4224	4257	4290	4323	33 (Riser) + 4323 (U)	90	105
Leather 1 N/A		Leather 2 N/A		Leather 3 N/A		Leather 4 N/A		Leather 5 N/A		Leather 6 N/A		Leather 8 N/A		COL N/A		S Nail N/A		M Nail N/A	

Fabric SKU: **6403-29-2** Leather SKU: **N/A**

LIBBY LANGDON FOR FAIRFIELD

Westway Corner Chair

Standard Pillows: (1) 20 x 20 **Finish Req:** N

Standard Cushions: Blendown **Standard Finish:** Nickel

COM: 9 yards **COL:** N/A

Width: 36.5 **Depth:** 36.5 **Height:** 34.5
AH: 0 **SH:** 20 **SD:** 22 **IW:** 22
Weight: 65 lbs **Cube:** 26.59

D	E	F	G	H	J	K COM	L	M	N	O	P	Q	R	S	T	U	(# above U) *	S Nail	M Nail
2955	2982	3009	3036	3063	3090	3117	3144	3171	3198	3225	3252	3279	3306	3333	3360	3387	27 (Riser) + 3387 (U)	45	60
Leather 1 N/A		Leather 2 N/A		Leather 3 N/A		Leather 4 N/A		Leather 5 N/A		Leather 6 N/A		Leather 8 N/A		COL N/A		S Nail N/A		M Nail N/A	

Fabric SKU: **6403-29-6** Leather SKU: **N/A**

LIBBY LANGDON FOR FAIRFIELD

Westway Corner Chair

Standard Pillows: (1) 20 x 20 **Finish Req:** N

Standard Cushions: Blendown **Standard Finish:** Brushed Brass

COM: 9 yards **COL:** N/A

Width: 36.5 **Depth:** 36.5 **Height:** 34.5
AH: 0 **SH:** 20 **SD:** 22 **IW:** 22
Weight: 65 lbs **Cube:** 26.59

D	E	F	G	H	J	K COM	L	M	N	O	P	Q	R	S	T	U	(# above U) *	S Nail	M Nail
2955	2982	3009	3036	3063	3090	3117	3144	3171	3198	3225	3252	3279	3306	3333	3360	3387	27 (Riser) + 3387 (U)	45	60
Leather 1 N/A		Leather 2 N/A		Leather 3 N/A		Leather 4 N/A		Leather 5 N/A		Leather 6 N/A		Leather 8 N/A		COL N/A		S Nail N/A		M Nail N/A	

Fabric SKU: **6403-50-2** Leather SKU: **L-6403-50-2**

LIBBY LANGDON FOR FAIRFIELD

Westway Sofa

Standard Pillows: (2) 20 x 20 **Finish Req:** N

Standard Cushions: Blendown **Standard Finish:** Nickel

COM: 14.5 yards **COL:** 209 square feet

Features with Nickel Metal Legs.

Width: 80.5 **Depth:** 36.5 **Height:** 34.5
AH: 23 **SH:** 20 **SD:** 22 **IW:** 70.5
Weight: 126 lbs **Cube:** 58.66

D	E	F	G	H	J	K COM	L	M	N	O	P	Q	R	S	T	U	(# above U) *	S Nail	M Nail
4950	4992	5034	5076	5118	5160	5202	5244	5286	5328	5370	5412	5454	5496	5538	5580	5622	42 (Riser) + 5622 (U)	150	165
Leather 1 7620		Leather 2 7935		Leather 3 8250		Leather 4 8565		Leather 5 8880		Leather 6 9195		Leather 8 12075		COL 5286		S Nail 150		M Nail 165	

Fabric SKU: **6403-50-6** Leather SKU: **L-6403-50-6**

LIBBY LANGDON FOR FAIRFIELD

Westway Sofa

Standard Pillows: (2) 20 x 20 **Finish Req:** N

Standard Cushions: Blendown **Standard Finish:** Brushed Brass

COM: 14.5 yards **COL:** 209 square feet

Features with Brushed Brass Metal Legs.

Width: 80.5 **Depth:** 36.5 **Height:** 34.5
AH: 23 **SH:** 20 **SD:** 22 **IW:** 70.5
Weight: 126 lbs **Cube:** 73.53

D	E	F	G	H	J	K COM	L	M	N	O	P	Q	R	S	T	U	(# above U) *	S Nail	M Nail
4950	4992	5034	5076	5118	5160	5202	5244	5286	5328	5370	5412	5454	5496	5538	5580	5622	42 (Riser) + 5622 (U)	150	165
Leather 1 7620		Leather 2 7935		Leather 3 8250		Leather 4 8565		Leather 5 8880		Leather 6 9195		Leather 8 12075		COL 5286		S Nail 150		M Nail 165	

Fabric SKU: **6403-51-2** Leather SKU: **N/A**

LIBBY LANGDON FOR FAIRFIELD

Westway Right Arm Facing Sofa

Standard Pillows: (1) 20 x 20 **Finish Req:** N

Standard Cushions: Blendown **Standard Finish:** Nickel

COM: 12 yards **COL:** N/A

Width: 75.5 **Depth:** 36.5 **Height:** 34.5
AH: 23.25 **SH:** 20 **SD:** 22 **IW:** 70.5
Weight: 120 lbs **Cube:** 55.01

D	E	F	G	H	J	K COM	L	M	N	O	P	Q	R	S	T	U	(# above U) *	S Nail	M Nail
4275	4311	4347	4383	4419	4455	4491	4527	4563	4599	4635	4671	4707	4743	4779	4815	4851	36 (Riser) + 4851 (U)	105	120
Leather 1 N/A		Leather 2 N/A		Leather 3 N/A		Leather 4 N/A		Leather 5 N/A		Leather 6 N/A		Leather 8 N/A		COL N/A		S Nail N/A		M Nail N/A	

Upholstery

**Pillows are not available on leather SKUs*

Fabric SKU: **6403-51-6** Leather SKU: **N/A**

LIBBY LANGDON FOR FAIRFIELD

Westway Right Arm Facing Sofa

Standard Pillows: (1) 20 x 20 **Finish Req:** N

Standard Cushions: Blendown **Standard Finish:** Brushed Brass

COM: 12 yards **COL:** N/A

Width: 75.5 **Depth:** 36.5 **Height:** 34.5

AH: 23.25 **SH:** 20 **SD:** 22 **IW:** 70.5

Weight: 120 lbs **Cube:** 55.01

D	E	F	G	H	J	K COM	L	M	N	O	P	Q	R	S	T	U	(# above U) *	S Nail	M Nail
4275	4311	4347	4383	4419	4455	4491	4527	4563	4599	4635	4671	4707	4743	4779	4815	4851	36 (Riser) + 4851 (U)	105	120
Leather 1 N/A		Leather 2 N/A		Leather 3 N/A		Leather 4 N/A		Leather 5 N/A		Leather 6 N/A		Leather 8 N/A		COL N/A		S Nail N/A		M Nail N/A	

Fabric SKU: **6403-52-2** Leather SKU: **N/A**

LIBBY LANGDON FOR FAIRFIELD

Westway Left Arm Facing Sofa

Standard Pillows: (1) 20 x 20 **Finish Req:** N

Standard Cushions: Blendown **Standard Finish:** Nickel

COM: 12 yards **COL:** N/A

Width: 75.5 **Depth:** 36.5 **Height:** 34.5

AH: 23.25 **SH:** 20 **SD:** 22 **IW:** 70.5

Weight: 120 lbs **Cube:** 55.01

D	E	F	G	H	J	K COM	L	M	N	O	P	Q	R	S	T	U	(# above U) *	S Nail	M Nail
4275	4311	4347	4383	4419	4455	4491	4527	4563	4599	4635	4671	4707	4743	4779	4815	4851	36 (Riser) + 4851 (U)	105	120
Leather 1 N/A		Leather 2 N/A		Leather 3 N/A		Leather 4 N/A		Leather 5 N/A		Leather 6 N/A		Leather 8 N/A		COL N/A		S Nail N/A		M Nail N/A	

Fabric SKU: **6403-52-6** Leather SKU: **N/A**

LIBBY LANGDON FOR FAIRFIELD

Westway Left Arm Facing Sofa

Standard Pillows: (1) 20 x 20 **Finish Req:** N

Standard Cushions: Blendown **Standard Finish:** Brushed Brass

COM: 12 yards **COL:** N/A

Width: 75.5 **Depth:** 36.5 **Height:** 34.5

AH: 23.25 **SH:** 20 **SD:** 22 **IW:** 70.5

Weight: 120 lbs **Cube:** 55.01

D	E	F	G	H	J	K COM	L	M	N	O	P	Q	R	S	T	U	(# above U) *	S Nail	M Nail
4275	4311	4347	4383	4419	4455	4491	4527	4563	4599	4635	4671	4707	4743	4779	4815	4851	36 (Riser) + 4851 (U)	105	120
Leather 1 N/A		Leather 2 N/A		Leather 3 N/A		Leather 4 N/A		Leather 5 N/A		Leather 6 N/A		Leather 8 N/A		COL N/A		S Nail N/A		M Nail N/A	

Fabric SKU: **6403-53-2** Leather SKU: **N/A**

LIBBY LANGDON FOR FAIRFIELD

Westway Right Arm Facing Corner Sofa

Standard Pillows: (3) 20 x 20 **Finish Req:** N

Standard Cushions: Blendown **Standard Finish:** Nickel

COM: 16.25 yards **COL:** N/A

Width: 87 **Depth:** 36.5 **Height:** 34.5

AH: 23.5 **SH:** 20 **SD:** 22 **IW:** 69

Weight: 130 lbs **Cube:** 68.15

D	E	F	G	H	J	K COM	L	M	N	O	P	Q	R	S	T	U	(# above U) *	S Nail	M Nail
5175	5223	5271	5319	5367	5415	5463	5511	5559	5607	5655	5703	5751	5799	5847	5895	5943	48 (Riser) + 5943 (U)	105	120
Leather 1 N/A		Leather 2 N/A		Leather 3 N/A		Leather 4 N/A		Leather 5 N/A		Leather 6 N/A		Leather 8 N/A		COL N/A		S Nail N/A		M Nail N/A	

Fabric SKU: **6403-53-6** Leather SKU: **N/A**

LIBBY LANGDON FOR FAIRFIELD

Westway Right Arm Facing Corner Sofa

Standard Pillows: (3) 20 x 20 **Finish Req:** N

Standard Cushions: Blendown **Standard Finish:** Brushed Brass

COM: 16.25 yards **COL:** N/A

Width: 87 **Depth:** 36.5 **Height:** 34.5

AH: 23.5 **SH:** 20 **SD:** 22 **IW:** 69

Weight: 130 lbs **Cube:** 63.39

D	E	F	G	H	J	K COM	L	M	N	O	P	Q	R	S	T	U	(# above U) *	S Nail	M Nail
5175	5223	5271	5319	5367	5415	5463	5511	5559	5607	5655	5703	5751	5799	5847	5895	5943	48 (Riser) + 5943 (U)	105	120
Leather 1 N/A		Leather 2 N/A		Leather 3 N/A		Leather 4 N/A		Leather 5 N/A		Leather 6 N/A		Leather 8 N/A		COL N/A		S Nail N/A		M Nail N/A	

Fabric SKU: **6403-54-2** Leather SKU: **N/A**

LIBBY LANGDON FOR FAIRFIELD

Westway Left Arm Facing Corner Sofa

Standard Pillows: (3) 20 x 20 **Finish Req:** N

Standard Cushions: Blendown **Standard Finish:** Nickel

COM: 16.25 yards **COL:** N/A

Width: 87 **Depth:** 36.5 **Height:** 34.5

AH: 23.5 **SH:** 20 **SD:** 22 **IW:** 69

Weight: 130 lbs **Cube:** 63.39

D	E	F	G	H	J	K COM	L	M	N	O	P	Q	R	S	T	U	(# above U) *	S Nail	M Nail
5175	5223	5271	5319	5367	5415	5463	5511	5559	5607	5655	5703	5751	5799	5847	5895	5943	48 (Riser) + 5943 (U)	105	120
Leather 1 N/A		Leather 2 N/A		Leather 3 N/A		Leather 4 N/A		Leather 5 N/A		Leather 6 N/A		Leather 8 N/A		COL N/A		S Nail N/A		M Nail N/A	

Upholstery

**Pillows are not available on leather SKUs*

Fabric SKU: **6403-54-6** Leather SKU: **N/A**
 LIBBY LANGDON FOR FAIRFIELD
Westway Left Arm Facing Corner Sofa

Standard Pillows: (3) 20 x 20 **Finish Req:** N
Standard Cushions: Blendown **Standard Finish:** Brushed Brass
COM: 16.25 yards **COL:** N/A

Width: 87 **Depth:** 36.5 **Height:** 34.5
AH: 23.5 **SH:** 20 **SD:** 22 **IW:** 69
Weight: 130 lbs **Cube:** 63.39

D	E	F	G	H	J	K COM	L	M	N	O	P	Q	R	S	T	U	(# above U) *	S Nail	M Nail
5175	5223	5271	5319	5367	5415	5463	5511	5559	5607	5655	5703	5751	5799	5847	5895	5943	48 (Riser) + 5943 (U)	105	120
Leather 1 N/A		Leather 2 N/A		Leather 3 N/A		Leather 4 N/A		Leather 5 N/A		Leather 6 N/A		Leather 8 N/A		COL N/A		S Nail N/A		M Nail N/A	

Fabric SKU: **6403-58-2** Leather SKU: **N/A**
 LIBBY LANGDON FOR FAIRFIELD
Westway Armless Sofa

Standard Pillows: N/A **Finish Req:** N
Standard Cushions: Blendown **Standard Finish:** Nickel
COM: 10.5 yards **COL:** N/A

Width: 70.5 **Depth:** 36.5 **Height:** 34.5
AH: 0 **SH:** 20 **SD:** 22 **IW:** 70.5
Weight: 103 lbs **Cube:** 70.78

D	E	F	G	H	J	K COM	L	M	N	O	P	Q	R	S	T	U	(# above U) *	S Nail	M Nail
4125	4158	4191	4224	4257	4290	4323	4356	4389	4422	4455	4488	4521	4554	4587	4620	4653	33 (Riser) + 4653 (U)	75	90
Leather 1 N/A		Leather 2 N/A		Leather 3 N/A		Leather 4 N/A		Leather 5 N/A		Leather 6 N/A		Leather 8 N/A		COL N/A		S Nail N/A		M Nail N/A	

Fabric SKU: **6403-58-6** Leather SKU: **N/A**
 LIBBY LANGDON FOR FAIRFIELD
Westway Armless Sofa

Standard Pillows: N/A **Finish Req:** N
Standard Cushions: Blendown **Standard Finish:** Brushed Brass
COM: 10.5 yards **COL:** N/A

Width: 70.5 **Depth:** 36.5 **Height:** 34.5
AH: 0 **SH:** 20 **SD:** 22 **IW:** 70.5
Weight: 103 lbs **Cube:** 51.37

D	E	F	G	H	J	K COM	L	M	N	O	P	Q	R	S	T	U	(# above U) *	S Nail	M Nail
4125	4158	4191	4224	4257	4290	4323	4356	4389	4422	4455	4488	4521	4554	4587	4620	4653	33 (Riser) + 4653 (U)	75	90
Leather 1 N/A		Leather 2 N/A		Leather 3 N/A		Leather 4 N/A		Leather 5 N/A		Leather 6 N/A		Leather 8 N/A		COL N/A		S Nail N/A		M Nail N/A	

Fabric SKU: **6403-70-2** Leather SKU: **N/A**
 LIBBY LANGDON FOR FAIRFIELD
Westway Loveseat

Standard Pillows: (2) 20 x 20 **Finish Req:** N
Standard Cushions: Blendown **Standard Finish:** Nickel
COM: 10.75 yards **COL:** N/A

Width: 57 **Depth:** 36.5 **Height:** 34.5
AH: 23.5 **SH:** 20 **SD:** 22 **IW:** 47
Weight: 100 lbs **Cube:** 41.53

D	E	F	G	H	J	K COM	L	M	N	O	P	Q	R	S	T	U	(# above U) *	S Nail	M Nail
3885	3918	3951	3984	4017	4050	4083	4116	4149	4182	4215	4248	4281	4314	4347	4380	4413	33 (Riser) + 4413 (U)	135	150
Leather 1 N/A		Leather 2 N/A		Leather 3 N/A		Leather 4 N/A		Leather 5 N/A		Leather 6 N/A		Leather 8 N/A		COL N/A		S Nail N/A		M Nail N/A	

Fabric SKU: **6403-70-6** Leather SKU: **N/A**
 LIBBY LANGDON FOR FAIRFIELD
Westway Loveseat

Standard Pillows: (2) 20 x 20 **Finish Req:** N
Standard Cushions: Blendown **Standard Finish:** Brushed Brass
COM: 10.75 yards **COL:** N/A

Width: 57 **Depth:** 36.5 **Height:** 34.5
AH: 23.5 **SH:** 20 **SD:** 22 **IW:** 47
Weight: 100 lbs **Cube:** 41.53

D	E	F	G	H	J	K COM	L	M	N	O	P	Q	R	S	T	U	(# above U) *	S Nail	M Nail
3885	3918	3951	3984	4017	4050	4083	4116	4149	4182	4215	4248	4281	4314	4347	4380	4413	33 (Riser) + 4413 (U)	135	150
Leather 1 N/A		Leather 2 N/A		Leather 3 N/A		Leather 4 N/A		Leather 5 N/A		Leather 6 N/A		Leather 8 N/A		COL N/A		S Nail N/A		M Nail N/A	

Fabric SKU: **6403-71-2** Leather SKU: **N/A**
 LIBBY LANGDON FOR FAIRFIELD
Westway Right Arm Loveseat

Standard Pillows: (1) 20 x 20 **Finish Req:** N
Standard Cushions: Blendown **Standard Finish:** Nickel
COM: 9 yards **COL:** N/A

Width: 52 **Depth:** 36.5 **Height:** 34.5
AH: 23.5 **SH:** 20 **SD:** 22 **IW:** 47
Weight: 94 lbs **Cube:** 37.89

D	E	F	G	H	J	K COM	L	M	N	O	P	Q	R	S	T	U	(# above U) *	S Nail	M Nail
3375	3402	3429	3456	3483	3510	3537	3564	3591	3618	3645	3672	3699	3726	3753	3780	3807	27 (Riser) + 3807 (U)	90	105
Leather 1 N/A		Leather 2 N/A		Leather 3 N/A		Leather 4 N/A		Leather 5 N/A		Leather 6 N/A		Leather 8 N/A		COL N/A		S Nail N/A		M Nail N/A	

Upholstery

**Pillows are not available on leather SKUs*

Fabric SKU: **6403-71-6** Leather SKU: **N/A**
 LIBBY LANGDON FOR FAIRFIELD
Westway Right Arm Loveseat

Standard Pillows: (1) 20 x 20 **Finish Req:** N
Standard Cushions: Blendown **Standard Finish:** Brushed Brass
COM: 9 yards **COL:** N/A

Width: 52 **Depth:** 36.5 **Height:** 34.5
AH: 23.5 **SH:** 20 **SD:** 22 **IW:** 47
Weight: 94 lbs **Cube:** 37.89

D	E	F	G	H	J	K COM	L	M	N	O	P	Q	R	S	T	U	(# above U) *	S Nail	M Nail
3375	3402	3429	3456	3483	3510	3537	3564	3591	3618	3645	3672	3699	3726	3753	3780	3807	27 (Riser) + 3807 (U)	90	105
Leather 1		Leather 2		Leather 3		Leather 4		Leather 5		Leather 6		Leather 8		COL		S Nail		M Nail	
N/A		N/A		N/A		N/A		N/A		N/A		N/A		N/A		N/A		N/A	

Fabric SKU: **6403-72-2** Leather SKU: **N/A**
 LIBBY LANGDON FOR FAIRFIELD
Westway Left Arm Loveseat

Standard Pillows: (1) 20 x 20 **Finish Req:** N
Standard Cushions: Blendown **Standard Finish:** Nickel
COM: 9 yards **COL:** N/A

Width: 52 **Depth:** 36.5 **Height:** 34.5
AH: 23.5 **SH:** 20 **SD:** 22 **IW:** 47
Weight: 94 lbs **Cube:** 37.89

D	E	F	G	H	J	K COM	L	M	N	O	P	Q	R	S	T	U	(# above U) *	S Nail	M Nail
3375	3402	3429	3456	3483	3510	3537	3564	3591	3618	3645	3672	3699	3726	3753	3780	3807	27 (Riser) + 3807 (U)	90	105
Leather 1		Leather 2		Leather 3		Leather 4		Leather 5		Leather 6		Leather 8		COL		S Nail		M Nail	
N/A		N/A		N/A		N/A		N/A		N/A		N/A		N/A		N/A		N/A	

Fabric SKU: **6403-72-6** Leather SKU: **N/A**
 LIBBY LANGDON FOR FAIRFIELD
Westway Left Arm Loveseat

Standard Pillows: (1) 20 x 20 **Finish Req:** N
Standard Cushions: Blendown **Standard Finish:** Brushed Brass
COM: 9 yards **COL:** N/A

Width: 52 **Depth:** 36.5 **Height:** 34.5
AH: 23.5 **SH:** 20 **SD:** 22 **IW:** 47
Weight: 94 lbs **Cube:** 37.89

D	E	F	G	H	J	K COM	L	M	N	O	P	Q	R	S	T	U	(# above U) *	S Nail	M Nail
3375	3402	3429	3456	3483	3510	3537	3564	3591	3618	3645	3672	3699	3726	3753	3780	3807	27 (Riser) + 3807 (U)	90	105
Leather 1		Leather 2		Leather 3		Leather 4		Leather 5		Leather 6		Leather 8		COL		S Nail		M Nail	
N/A		N/A		N/A		N/A		N/A		N/A		N/A		N/A		N/A		N/A	

Fabric SKU: **6403-78-2** Leather SKU: **N/A**
 LIBBY LANGDON FOR FAIRFIELD
Westway Armless Chair

Standard Pillows: N/A **Finish Req:** N
Standard Cushions: Blendown **Standard Finish:** Nickel
COM: 4.5 yards **COL:** N/A

Width: 23.5 **Depth:** 36.5 **Height:** 34.5
AH: 0 **SH:** 20 **SD:** 22 **IW:** 23.5
Weight: 51 lbs **Cube:** 17.12

D	E	F	G	H	J	K COM	L	M	N	O	P	Q	R	S	T	U	(# above U) *	S Nail	M Nail
2220	2235	2250	2265	2280	2295	2310	2325	2340	2355	2370	2385	2400	2415	2430	2445	2460	15 (Riser) + 2460 (U)	45	60
Leather 1		Leather 2		Leather 3		Leather 4		Leather 5		Leather 6		Leather 8		COL		S Nail		M Nail	
N/A		N/A		N/A		N/A		N/A		N/A		N/A		N/A		N/A		N/A	

Fabric SKU: **6403-78-6** Leather SKU: **N/A**
 LIBBY LANGDON FOR FAIRFIELD
Westway Armless Chair

Standard Pillows: N/A **Finish Req:** N
Standard Cushions: Blendown **Standard Finish:** Brushed Brass
COM: 4.5 yards **COL:** N/A

Width: 23.5 **Depth:** 36.5 **Height:** 34.5
AH: 0 **SH:** 20 **SD:** 22 **IW:** 23.5
Weight: 51 lbs **Cube:** 17.12

D	E	F	G	H	J	K COM	L	M	N	O	P	Q	R	S	T	U	(# above U) *	S Nail	M Nail
2220	2235	2250	2265	2280	2295	2310	2325	2340	2355	2370	2385	2400	2415	2430	2445	2460	15 (Riser) + 2460 (U)	45	60
Leather 1		Leather 2		Leather 3		Leather 4		Leather 5		Leather 6		Leather 8		COL		S Nail		M Nail	
N/A		N/A		N/A		N/A		N/A		N/A		N/A		N/A		N/A		N/A	

Fabric SKU: **6403-79-2** Leather SKU: **N/A**
 LIBBY LANGDON FOR FAIRFIELD
Westway Armless Loveseat

Standard Pillows: N/A **Finish Req:** N
Standard Cushions: Blendown **Standard Finish:** Nickel
COM: 7.5 yards **COL:** N/A

Width: 47 **Depth:** 36.5 **Height:** 34.5
AH: 0 **SH:** 20 **SD:** 22 **IW:** 47
Weight: 88 lbs **Cube:** 34.25

D	E	F	G	H	J	K COM	L	M	N	O	P	Q	R	S	T	U	(# above U) *	S Nail	M Nail
3150	3171	3192	3213	3234	3255	3276	3297	3318	3339	3360	3381	3402	3423	3444	3465	3486	21 (Riser) + 3486 (U)	60	75
Leather 1		Leather 2		Leather 3		Leather 4		Leather 5		Leather 6		Leather 8		COL		S Nail		M Nail	
N/A		N/A		N/A		N/A		N/A		N/A		N/A		N/A		N/A		N/A	

Upholstery

**Pillows are not available on leather SKUs*

Fabric SKU: **6403-79-6** Leather SKU: **N/A**

LIBBY LANGDON FOR FAIRFIELD

Westway Armless Loveseat

Standard Pillows: N/A **Finish Req:** N

Standard Cushions: Blendown **Standard Finish:** Brushed Brass

COM: 7.5 yards **COL:** N/A

Width: 47 **Depth:** 36.5 **Height:** 34.5

AH: 0 **SH:** 20 **SD:** 22 **IW:** 47

Weight: 88 lbs **Cube:** 34.25

D	E	F	G	H	J	K COM	L	M	N	O	P	Q	R	S	T	U	(# above U) *	S Nail	M Nail
3150	3171	3192	3213	3234	3255	3276	3297	3318	3339	3360	3381	3402	3423	3444	3465	3486	21 (Riser) + 3486 (U)	60	75
Leather 1		Leather 2		Leather 3		Leather 4		Leather 5		Leather 6		Leather 8		COL		S Nail		M Nail	
N/A		N/A		N/A		N/A		N/A		N/A		N/A		N/A		N/A		N/A	

Fabric SKU: **6404-01** Leather SKU: **N/A**

LIBBY LANGDON FOR FAIRFIELD

Ginny Occasional Chair

Standard Pillows: N/A **Finish Req:** Y

Standard Cushions: High Resiliency 30 **Standard Finish:**

COM: 3.75 yards **COL:** N/A

Width: 27.5 **Depth:** 27.75 **Height:** 29

AH: 3.5 **SH:** 19.25 **SD:** 21.5 **IW:** 21.5

Weight: 29 lbs **Cube:** 21.65

D	E	F	G	H	J	K COM	L	M	N	O	P	Q	R	S	T	U	(# above U) *	S Nail	M Nail
1875	1887	1899	1911	1923	1935	1947	1959	1971	1983	1995	2007	2019	2031	2043	2055	2067	12 (Riser) + 2067 (U)	75	90
Leather 1		Leather 2		Leather 3		Leather 4		Leather 5		Leather 6		Leather 8		COL		S Nail		M Nail	
N/A		N/A		N/A		N/A		N/A		N/A		N/A		N/A		N/A		N/A	

Fabric SKU: **6405-01-6** Leather SKU: **L-6405-01-6**

LIBBY LANGDON FOR FAIRFIELD

Hinsdale Occasional Chair

Standard Pillows: N/A **Finish Req:** N

Standard Cushions: High Resiliency 30 **Standard Finish:** Brushed Brass

COM: 3.25 yards **COL:** 62 square feet

Width: 25.25 **Depth:** 29 **Height:** 34

AH: 23.5 **SH:** 20 **SD:** 21 **IW:** 20.25

Weight: 41 lbs **Cube:** 23.89

D	E	F	G	H	J	K COM	L	M	N	O	P	Q	R	S	T	U	(# above U) *	S Nail	M Nail
2430	2439	2448	2457	2466	2475	2484	2493	2502	2511	2520	2529	2538	2547	2556	2565	2574	9 (Riser) + 2574 (U)	N/A	N/A
Leather 1		Leather 2		Leather 3		Leather 4		Leather 5		Leather 6		Leather 8		COL		S Nail		M Nail	
3300		3405		3510		3615		3720		3825		4680		2502		N/A		N/A	

Fabric SKU: **6407-01-2** Leather SKU: **N/A**

LIBBY LANGDON FOR FAIRFIELD

Lowell Lounge Chair

Standard Pillows: N/A **Finish Req:** N

Standard Cushions: High Resiliency 40 **Standard Finish:** Nickel

COM: 4.5 yards **COL:** N/A

Width: 30.5 **Depth:** 33.5 **Height:** 34.25

AH: 19.5 **SH:** 18.5 **SD:** 22.5 **IW:** 22.5

Weight: 52 lbs **Cube:** 23.89

D	E	F	G	H	J	K COM	L	M	N	O	P	Q	R	S	T	U	(# above U) *	S Nail	M Nail
2610	2625	2640	2655	2670	2685	2700	2715	2730	2745	2760	2775	2790	2805	2820	2835	2850	15 (Riser) + 2850 (U)	N/A	N/A
Leather 1		Leather 2		Leather 3		Leather 4		Leather 5		Leather 6		Leather 8		COL		S Nail		M Nail	
N/A		N/A		N/A		N/A		N/A		N/A		N/A		N/A		N/A		N/A	

Fabric SKU: **6407-31-2** Leather SKU: **N/A**

LIBBY LANGDON FOR FAIRFIELD

Lowell Swivel Chair

Standard Pillows: N/A **Finish Req:** N

Standard Cushions: High Resiliency 40 **Standard Finish:** Nickel

COM: 4.75 yards **COL:** N/A

Width: 30.5 **Depth:** 33.5 **Height:** 34.25

AH: 19.5 **SH:** 18.5 **SD:** 22.5 **IW:** 22.5

Weight: 52 lbs **Cube:** 29.69

D	E	F	G	H	J	K COM	L	M	N	O	P	Q	R	S	T	U	(# above U) *	S Nail	M Nail
2775	2790	2805	2820	2835	2850	2865	2880	2895	2910	2925	2940	2955	2970	2985	3000	3015	15 (Riser) + 3015 (U)	N/A	N/A
Leather 1		Leather 2		Leather 3		Leather 4		Leather 5		Leather 6		Leather 8		COL		S Nail		M Nail	
N/A		N/A		N/A		N/A		N/A		N/A		N/A		N/A		N/A		N/A	

Fabric SKU: **6408-01** Leather SKU: **L-6408-01**

LIBBY LANGDON FOR FAIRFIELD

Percy Wing Chair

Standard Pillows: (1) Kidney **Finish Req:** Y

Standard Cushions: Blendown **Standard Finish:**

COM: 5.5 yards **COL:** 102 square feet

Width: 28 **Depth:** 33.5 **Height:** 35.5

AH: 23.25 **SH:** 19.5 **SD:** 23 **IW:** 21.5

Weight: 47 lbs **Cube:** 23.89

D	E	F	G	H	J	K COM	L	M	N	O	P	Q	R	S	T	U	(# above U) *	S Nail	M Nail
2550	2568	2586	2604	2622	2640	2658	2676	2694	2712	2730	2748	2766	2784	2802	2820	2838	18 (Riser) + 2838 (U)	Std.	45
Leather 1		Leather 2		Leather 3		Leather 4		Leather 5		Leather 6		Leather 8		COL		S Nail		M Nail	
3825		3990		4155		4320		4485		4650		6060		2694		Std.		45	

Upholstery

**Pillows are not available on leather SKUs*

Fabric SKU: **6408-20** Leather SKU: **L-6408-20**
 LIBBY LANGDON FOR FAIRFIELD
Percy Ottoman

Standard Pillows: N/A **Finish Req:** Y
Standard Cushions: High Resiliency 30 **Standard Finish:**
COM: 2.5 yards **COL:** 51 square feet

Width: 24 **Depth:** 19.5 **Height:** 18
AH: 0 **SH:** 0 **SD:** 0 **IW:** 0
Weight: 15 lbs **Cube:** 0.1

D	E	F	G	H	J	K COM	L	M	N	O	P	Q	R	S	T	U	(# above U) *	S Nail	M Nail
1125	1134	1143	1152	1161	1170	1179	1188	1197	1206	1215	1224	1233	1242	1251	1260	1269	9 (Riser) + 1269 (U)	30	45
Leather 1 1905		Leather 2 1980		Leather 3 2055		Leather 4 2130		Leather 5 2205		Leather 6 2280		Leather 8 2985		COL 1197		S Nail 30		M Nail 45	

Fabric SKU: **6409-01** Leather SKU: **L-6409-01**
 LIBBY LANGDON FOR FAIRFIELD
Trident Lounge Chair

Standard Pillows: N/A **Finish Req:** Y
Standard Cushions: Blendown **Standard Finish:**
COM: 5.5 yards **COL:** 102 square feet

Width: 29.5 **Depth:** 36.5 **Height:** 36.5
AH: 25 **SH:** 20 **SD:** 24 **IW:** 22
Weight: 45 lbs **Cube:** 23.89

D	E	F	G	H	J	K COM	L	M	N	O	P	Q	R	S	T	U	(# above U) *	S Nail	M Nail
2475	2493	2511	2529	2547	2565	2583	2601	2619	2637	2655	2673	2691	2709	2727	2745	2763	18 (Riser) + 2763 (U)	90	N/A
Leather 1 3645		Leather 2 3810		Leather 3 3975		Leather 4 4140		Leather 5 4305		Leather 6 4470		Leather 8 5880		COL 2619		S Nail 90		M Nail N/A	

Fabric SKU: **6409-31** Leather SKU: **L-6409-31**
 LIBBY LANGDON FOR FAIRFIELD
Trident Swivel Chair

Standard Pillows: N/A **Finish Req:** Y
Standard Cushions: Blendown **Standard Finish:**
COM: 5.5 yards **COL:** 90.95 square feet

Width: 29.5 **Depth:** 36.5 **Height:** 36.5
AH: 25 **SH:** 20 **SD:** 24 **IW:** 22
Weight: 45 lbs **Cube:** 29.69

D	E	F	G	H	J	K COM	L	M	N	O	P	Q	R	S	T	U	(# above U) *	S Nail	M Nail
2550	2568	2586	2604	2622	2640	2658	2676	2694	2712	2730	2748	2766	2784	2802	2820	2838	18 (Riser) + 2838 (U)	90	N/A
Leather 1 3735		Leather 2 3870		Leather 3 4005		Leather 4 4140		Leather 5 4275		Leather 6 4410		Leather 8 5670		COL 2694		S Nail 90		M Nail N/A	

Fabric SKU: **6409-31-2** Leather SKU: **L-6409-31-2**
 LIBBY LANGDON FOR FAIRFIELD
Trident Swivel Chair

Standard Pillows: N/A **Finish Req:** N
Standard Cushions: Blendown **Standard Finish:** Nickel
COM: 5.5 yards **COL:** 90.95 square feet

Width: 29.5 **Depth:** 36.5 **Height:** 36.5
AH: 25 **SH:** 20 **SD:** 24 **IW:** 22
Weight: 45 lbs **Cube:** 34.38

D	E	F	G	H	J	K COM	L	M	N	O	P	Q	R	S	T	U	(# above U) *	S Nail	M Nail
2700	2718	2736	2754	2772	2790	2808	2826	2844	2862	2880	2898	2916	2934	2952	2970	2988	18 (Riser) + 2988 (U)	90	N/A
Leather 1 3810		Leather 2 3945		Leather 3 4080		Leather 4 4215		Leather 5 4350		Leather 6 4485		Leather 8 5745		COL 2844		S Nail 90		M Nail N/A	

Fabric SKU: **6409-31-7** Leather SKU: **L-6409-31-7**
 LIBBY LANGDON FOR FAIRFIELD
Trident Swivel Chair

Standard Pillows: N/A **Finish Req:** N
Standard Cushions: Blendown **Standard Finish:** Bright Brass
COM: 5.5 yards **COL:** 90.95 square feet

Width: 29.5 **Depth:** 36.5 **Height:** 36.5
AH: 25 **SH:** 20 **SD:** 24 **IW:** 22
Weight: 45 lbs **Cube:** 23.89

D	E	F	G	H	J	K COM	L	M	N	O	P	Q	R	S	T	U	(# above U) *	S Nail	M Nail
2700	2718	2736	2754	2772	2790	2808	2826	2844	2862	2880	2898	2916	2934	2952	2970	2988	18 (Riser) + 2988 (U)	90	N/A
Leather 1 3810		Leather 2 3945		Leather 3 4080		Leather 4 4215		Leather 5 4350		Leather 6 4485		Leather 8 5745		COL 2844		S Nail 90		M Nail N/A	

Fabric SKU: **6410-01** Leather SKU: **L-6410-01**
 LIBBY LANGDON FOR FAIRFIELD
McAlear Occasional Chair

Standard Pillows: N/A **Finish Req:** Y
Standard Cushions: High Resiliency 30 **Standard Finish:**
COM: 3.25 yards **COL:** 57 square feet

Width: 26.5 **Depth:** 27.25 **Height:** 32
AH: 27.5 **SH:** 19 **SD:** 21 **IW:** 25
Weight: 27 lbs **Cube:** 21.65

D	E	F	G	H	J	K COM	L	M	N	O	P	Q	R	S	T	U	(# above U) *	S Nail	M Nail
1725	1734	1743	1752	1761	1770	1779	1788	1797	1806	1815	1824	1833	1842	1851	1860	1869	9 (Riser) + 1869 (U)	60	N/A
Leather 1 2685		Leather 2 2775		Leather 3 2865		Leather 4 2955		Leather 5 3045		Leather 6 3135		Leather 8 3930		COL 1797		S Nail 60		M Nail N/A	

Upholstery

**Pillows are not available on leather SKUs*

Fabric SKU: **6412-01** Leather SKU: **L-6412-01**

LIBBY LANGDON FOR FAIRFIELD

Maycroft Occasional Chair

Standard Pillows: N/A **Finish Req:** Y

Standard Cushions: High Resiliency 30 **Standard Finish:**

COM: 3.5 yards **COL:** 68 square feet

Width: 29 **Depth:** 27 **Height:** 33.5

AH: 24 **SH:** 18.5 **SD:** 19 **IW:** 22

Weight: 34 lbs **Cube:** 23.89

D	E	F	G	H	J	K COM	L	M	N	O	P	Q	R	S	T	U	(# above U) *	S Nail	M Nail
1800	1809	1818	1827	1836	1845	1854	1863	1872	1881	1890	1899	1908	1917	1926	1935	1944	9 (Riser) + 1944 (U)	75	90
Leather 1		Leather 2		Leather 3		Leather 4		Leather 5		Leather 6		Leather 8		COL		S Nail		M Nail	
3060		3165		3270		3375		3480		3585		4530		1872		75		90	

Fabric SKU: **6450-04** Leather SKU: **L-6450-04**

LIBBY LANGDON FOR FAIRFIELD

Watermill Arm Chair

Standard Pillows: N/A **Finish Req:** Y

Standard Cushions: High Resiliency 30 **Standard Finish:**

COM: 3.5 yards **COL:** 62 square feet

Width: 23.75 **Depth:** 28.5 **Height:** 39

AH: 24.5 **SH:** 19.5 **SD:** 19.5 **IW:** 20

Weight: 23 lbs **Cube:** 21.65

D	E	F	G	H	J	K COM	L	M	N	O	P	Q	R	S	T	U	(# above U) *	S Nail	M Nail
1650	1659	1668	1677	1686	1695	1704	1713	1722	1731	1740	1749	1758	1767	1776	1785	1794	9 (Riser) + 1794 (U)	45	60
Leather 1		Leather 2		Leather 3		Leather 4		Leather 5		Leather 6		Leather 8		COL		S Nail		M Nail	
2400		2505		2610		2715		2820		2925		3780		1722		45		60	

Fabric SKU: **6450-05** Leather SKU: **L-6450-05**

LIBBY LANGDON FOR FAIRFIELD

Watermill Side Chair

Standard Pillows: N/A **Finish Req:** Y

Standard Cushions: High Resiliency 30 **Standard Finish:**

COM: 2.75 yards **COL:** 57 square feet

Width: 23.75 **Depth:** 28.5 **Height:** 39

AH: 19.5 **SH:** 19.5 **SD:** 19.5 **IW:** 20

Weight: 22 lbs **Cube:** 21.65

D	E	F	G	H	J	K COM	L	M	N	O	P	Q	R	S	T	U	(# above U) *	S Nail	M Nail
1620	1629	1638	1647	1656	1665	1674	1683	1692	1701	1710	1719	1728	1737	1746	1755	1764	9 (Riser) + 1764 (U)	45	60
Leather 1		Leather 2		Leather 3		Leather 4		Leather 5		Leather 6		Leather 8		COL		S Nail		M Nail	
2370		2460		2550		2640		2730		2820		3615		1692		45		60	

Fabric SKU: **6451-04** Leather SKU: **L-6451-04**

LIBBY LANGDON FOR FAIRFIELD

Briarcroft Arm Chair

Standard Pillows: N/A **Finish Req:** Y

Standard Cushions: High Resiliency 30 **Standard Finish:**

COM: 3.75 yards **COL:** 68 square feet

Width: 22 **Depth:** 26.5 **Height:** 41.5

AH: 25.5 **SH:** 20 **SD:** 18 **IW:** 18

Weight: 26 lbs **Cube:** 17.77

D	E	F	G	H	J	K COM	L	M	N	O	P	Q	R	S	T	U	(# above U) *	S Nail	M Nail
1920	1932	1944	1956	1968	1980	1992	2004	2016	2028	2040	2052	2064	2076	2088	2100	2112	12 (Riser) + 2112 (U)	60	N/A
Leather 1		Leather 2		Leather 3		Leather 4		Leather 5		Leather 6		Leather 8		COL		S Nail		M Nail	
2850		2955		3060		3165		3270		3375		4320		2016		60		N/A	

Fabric SKU: **6452-04** Leather SKU: **L-6452-04**

LIBBY LANGDON FOR FAIRFIELD

Sayers Arm Chair

Standard Pillows: N/A **Finish Req:** N

Standard Cushions: High Resiliency 40 **Standard Finish:** Cerused Espresso

COM: 1.5 yards **COL:** 24.3 square feet

Features natural cane accents that was handwoven using the peel of natural rattan. As with any natural product, nature's imperfections and hallmarks will be present in the cane materials. Cane is a handcrafted product dating back to the Ancient Egyptians.

Width: 23.5 **Depth:** 27 **Height:** 36.5

AH: 25 **SH:** 20 **SD:** 18.5 **IW:** 20.25

Weight: 24 lbs **Cube:** 21.65

D	E	F	G	H	J	K COM	L	M	N	O	P	Q	R	S	T	U	(# above U) *	S Nail	M Nail
1770	1779	1788	1797	1806	1815	1824	1833	1842	1851	1860	1869	1878	1887	1896	1905	1914	9 (Riser) + 1914 (U)	N/A	N/A
Leather 1		Leather 2		Leather 3		Leather 4		Leather 5		Leather 6		Leather 8		COL		S Nail		M Nail	
2070		2115		2160		2205		2250		2295		2640		1842		N/A		N/A	

Fabric SKU: **6453-04** Leather SKU: **L-6453-04**

LIBBY LANGDON FOR FAIRFIELD

Sayers Arm Chair

Standard Pillows: N/A **Finish Req:** Y

Standard Cushions: High Resiliency 40 **Standard Finish:**

COM: 1.5 yards **COL:** 24.3 square feet

Features natural cane accents that was handwoven using the peel of natural rattan. As with any natural product, nature's imperfections and hallmarks will be present in the cane materials. Cane is a handcrafted product dating back to the Ancient Egyptians.

Width: 23.5 **Depth:** 27 **Height:** 36.5

AH: 25 **SH:** 20 **SD:** 18.5 **IW:** 20.25

Weight: 24 lbs **Cube:** 21.65

D	E	F	G	H	J	K COM	L	M	N	O	P	Q	R	S	T	U	(# above U) *	S Nail	M Nail
1950	1959	1968	1977	1986	1995	2004	2013	2022	2031	2040	2049	2058	2067	2076	2085	2094	9 (Riser) + 2094 (U)	N/A	N/A
Leather 1		Leather 2		Leather 3		Leather 4		Leather 5		Leather 6		Leather 8		COL		S Nail		M Nail	
2295		2340		2385		2430		2475		2520		2865		2022		N/A		N/A	

Upholstery

**Pillows are not available on leather SKUs*

Fabric SKU: **6454-04** Leather SKU: **L-6454-04**
LIBBY LANGDON FOR FAIRFIELD
Stratford Arm Chair

Standard Pillows: N/A **Finish Req:** Y
Standard Cushions: High Resiliency 35 **Standard Finish:**
COM: 3.75 yards **COL:** 63 square feet

Width: 25.5 **Depth:** 28.5 **Height:** 39.5
AH: 25 **SH:** 18.5 **SD:** 19.5 **IW:** 19
Weight: 26 lbs **Cube:** 21.65

D	E	F	G	H	J	K COM	L	M	N	O	P	Q	R	S	T	U	(# above U) *	S Nail	M Nail
1800	1812	1824	1836	1848	1860	1872	1884	1896	1908	1920	1932	1944	1956	1968	1980	1992	12 (Riser) + 1992 (U)	90	N/A
Leather 1 2760		Leather 2 2865		Leather 3 2970		Leather 4 3075		Leather 5 3180		Leather 6 3285		Leather 8 4155		COL 1896		S Nail 90		M Nail N/A	

Fabric SKU: **6455-05** Leather SKU: **L-6455-05**
LIBBY LANGDON FOR FAIRFIELD
Hemdale Side Chair

Standard Pillows: N/A **Finish Req:** Y
Standard Cushions: High Resiliency 40 **Standard Finish:**
COM: 2.5 yards **COL:** 45 square feet

Width: 20 **Depth:** 26 **Height:** 36.5
AH: 0 **SH:** 19.5 **SD:** 19 **IW:** 0
Weight: 20 lbs **Cube:** 15.74

D	E	F	G	H	J	K COM	L	M	N	O	P	Q	R	S	T	U	(# above U) *	S Nail	M Nail
1245	1254	1263	1272	1281	1290	1299	1308	1317	1326	1335	1344	1353	1362	1371	1380	1389	9 (Riser) + 1389 (U)	45	N/A
Leather 1 1920		Leather 2 1995		Leather 3 2070		Leather 4 2145		Leather 5 2220		Leather 6 2295		Leather 8 2925		COL 1317		S Nail 45		M Nail N/A	

Fabric SKU: **6456-04** Leather SKU: **L-6456-04**
LIBBY LANGDON FOR FAIRFIELD
Thompson Arm Chair

Standard Pillows: N/A **Finish Req:** Y
Standard Cushions: High Resiliency 40 **Standard Finish:**
COM: 2.5 yards **COL:** 51 square feet

Width: 22.5 **Depth:** 26.5 **Height:** 38
AH: 25 **SH:** 19 **SD:** 18 **IW:** 19
Weight: 18 lbs **Cube:** 15.74

D	E	F	G	H	J	K COM	L	M	N	O	P	Q	R	S	T	U	(# above U) *	S Nail	M Nail
1410	1419	1428	1437	1446	1455	1464	1473	1482	1491	1500	1509	1518	1527	1536	1545	1554	9 (Riser) + 1554 (U)	45	60
Leather 1 2145		Leather 2 2220		Leather 3 2295		Leather 4 2370		Leather 5 2445		Leather 6 2520		Leather 8 3225		COL 1482		S Nail 45		M Nail 60	

Fabric SKU: **6456-05** Leather SKU: **L-6456-05**
LIBBY LANGDON FOR FAIRFIELD
Thompson Side Chair

Standard Pillows: N/A **Finish Req:** Y
Standard Cushions: High Resiliency 40 **Standard Finish:**
COM: 2.5 yards **COL:** 51 square feet

Width: 22.5 **Depth:** 26.5 **Height:** 38
AH: 0 **SH:** 19 **SD:** 18 **IW:** 19
Weight: 16 lbs **Cube:** 15.74

D	E	F	G	H	J	K COM	L	M	N	O	P	Q	R	S	T	U	(# above U) *	S Nail	M Nail
1320	1329	1338	1347	1356	1365	1374	1383	1392	1401	1410	1419	1428	1437	1446	1455	1464	9 (Riser) + 1464 (U)	45	60
Leather 1 2115		Leather 2 2190		Leather 3 2265		Leather 4 2340		Leather 5 2415		Leather 6 2490		Leather 8 3195		COL 1392		S Nail 45		M Nail 60	

Fabric SKU: **6469-01** Leather SKU: **L-6469-01**
LIBBY LANGDON FOR FAIRFIELD
Halsey Lounge Chair

Standard Pillows: N/A **Finish Req:** Y
Standard Cushions: Ultra Plush **Standard Finish:**
COM: 7.75 yards **COL:** 130 square feet
Chair version of the 469C-MR & 469C-PR Recliner.

Width: 25.5 **Depth:** 36.5 **Height:** 39.25
AH: 25.5 **SH:** 20 **SD:** 20 **IW:** 21
Weight: 73 lbs **Cube:** 29.69

D	E	F	G	H	J	K COM	L	M	N	O	P	Q	R	S	T	U	(# above U) *	S Nail	M Nail
2700	2721	2742	2763	2784	2805	2826	2847	2868	2889	2910	2931	2952	2973	2994	3015	3036	21 (Riser) + 3036 (U)	75	90
Leather 1 4350		Leather 2 4545		Leather 3 4740		Leather 4 4935		Leather 5 5130		Leather 6 5325		Leather 8 7110		COL 2868		S Nail 75		M Nail 90	

Fabric SKU: **6469-20** Leather SKU: **L-6469-20**
LIBBY LANGDON FOR FAIRFIELD
Halsey Ottoman

Standard Pillows: N/A **Finish Req:** Y
Standard Cushions: High Resiliency 30 **Standard Finish:**
COM: 2.25 yards **COL:** 45 square feet

Width: 22.25 **Depth:** 19.25 **Height:** 18.25
AH: 0 **SH:** 0 **SD:** 0 **IW:** 0
Weight: 12 lbs **Cube:** 4.52

D	E	F	G	H	J	K COM	L	M	N	O	P	Q	R	S	T	U	(# above U) *	S Nail	M Nail
1125	1134	1143	1152	1161	1170	1179	1188	1197	1206	1215	1224	1233	1242	1251	1260	1269	9 (Riser) + 1269 (U)	30	45
Leather 1 1935		Leather 2 2010		Leather 3 2085		Leather 4 2160		Leather 5 2235		Leather 6 2310		Leather 8 2940		COL 1197		S Nail 30		M Nail 45	

Upholstery

**Pillows are not available on leather SKUs*

Fabric SKU: **6500-C7** Leather SKU: **L-6500-C7**

LIBBY LANGDON FOR FAIRFIELD

Morrison Counter Stool

Standard Pillows: N/A **Finish Req:** Y

Standard Cushions: High Resiliency 40 **Standard Finish:**

COM: 2 yards **COL:** 40 square feet

Standard with Nickel Footrest

Width: 21 **Depth:** 23 **Height:** 33

AH: 0 **SH:** 24.75 **SD:** 17 **IW:** 18.5

Weight: 22 lbs **Cube:** 9.22

D	E	F	G	H	J	K COM	L	M	N	O	P	Q	R	S	T	U	(# above U) *	S Nail	M Nail
1500	1506	1512	1518	1524	1530	1536	1542	1548	1554	1560	1566	1572	1578	1584	1590	1596	6 (Riser) + 1596 (U)	N/A	N/A
Leather 1 2055		Leather 2 2115		Leather 3 2175		Leather 4 2235		Leather 5 2295		Leather 6 2355		Leather 8 2910		COL 1548		S Nail N/A		M Nail N/A	

Fabric SKU: **6600-10** Leather SKU: **L-6600-10**

LIBBY LANGDON FOR FAIRFIELD

Brookwood Bench

Standard Pillows: N/A **Finish Req:** Y

Standard Cushions: High Resiliency 30 **Standard Finish:**

COM: 3.5 yards **COL:** 68 square feet

Width: 51.75 **Depth:** 15.5 **Height:** 21.25

AH: 21.25 **SH:** 20 **SD:** 15 **IW:** 50.5

Weight: 29 lbs **Cube:** 23.16

D	E	F	G	H	J	K COM	L	M	N	O	P	Q	R	S	T	U	(# above U) *	S Nail	M Nail
1770	1782	1794	1806	1818	1830	1842	1854	1866	1878	1890	1902	1914	1926	1938	1950	1962	12 (Riser) + 1962 (U)	N/A	N/A
Leather 1 2640		Leather 2 2745		Leather 3 2850		Leather 4 2955		Leather 5 3060		Leather 6 3165		Leather 8 4110		COL 1866		S Nail N/A		M Nail N/A	

Fabric SKU: **6602-20** Leather SKU: **L-6602-20**

LIBBY LANGDON FOR FAIRFIELD

Dryer Ottoman

Standard Pillows: N/A **Finish Req:** Y

Standard Cushions: High Resiliency 30 **Standard Finish:**

COM: 2 yards **COL:** 34.2 square feet

Width: 20.5 **Depth:** 20.5 **Height:** 20

AH: 0 **SH:** 0 **SD:** 0 **IW:** 0

Weight: 23 lbs **Cube:** 10.77

D	E	F	G	H	J	K COM	L	M	N	O	P	Q	R	S	T	U	(# above U) *	S Nail	M Nail
1305	1311	1317	1323	1329	1335	1341	1347	1353	1359	1365	1371	1377	1383	1389	1395	1401	6 (Riser) + 1401 (U)	30	N/A
Leather 1 1980		Leather 2 2040		Leather 3 2100		Leather 4 2160		Leather 5 2220		Leather 6 2280		Leather 8 2760		COL 1353		S Nail 30		M Nail N/A	

Fabric SKU: **6602-36** Leather SKU: **L-6602-36**

LIBBY LANGDON FOR FAIRFIELD

Dryer Cocktail Ottoman

Standard Pillows: N/A **Finish Req:** Y

Standard Cushions: High Resiliency 30 **Standard Finish:**

COM: 4.5 yards **COL:** 57 square feet

Width: 36.5 **Depth:** 36.5 **Height:** 20

AH: 0 **SH:** 0 **SD:** 0 **IW:** 0

Weight: 58 lbs **Cube:** 21.15

D	E	F	G	H	J	K COM	L	M	N	O	P	Q	R	S	T	U	(# above U) *	S Nail	M Nail
1755	1770	1785	1800	1815	1830	1845	1860	1875	1890	1905	1920	1935	1950	1965	1980	1995	15 (Riser) + 1995 (U)	45	N/A
Leather 1 2640		Leather 2 2745		Leather 3 2850		Leather 4 2955		Leather 5 3060		Leather 6 3165		Leather 8 4035		COL 1875		S Nail 45		M Nail N/A	

Fabric SKU: **6602-44** Leather SKU: **L-6602-44**

LIBBY LANGDON FOR FAIRFIELD

Dryer Cocktail Ottoman

Standard Pillows: N/A **Finish Req:** Y

Standard Cushions: High Resiliency 30 **Standard Finish:**

COM: 5.25 yards **COL:** 79 square feet

Width: 44.5 **Depth:** 44.5 **Height:** 20

AH: 0 **SH:** 0 **SD:** 0 **IW:** 0

Weight: 84 lbs **Cube:** 28.93

D	E	F	G	H	J	K COM	L	M	N	O	P	Q	R	S	T	U	(# above U) *	S Nail	M Nail
2010	2028	2046	2064	2082	2100	2118	2136	2154	2172	2190	2208	2226	2244	2262	2280	2298	18 (Riser) + 2298 (U)	60	N/A
Leather 1 3225		Leather 2 3345		Leather 3 3465		Leather 4 3585		Leather 5 3705		Leather 6 3825		Leather 8 4920		COL 2154		S Nail 60		M Nail N/A	

Fabric SKU: **6602-52** Leather SKU: **L-6602-52**

LIBBY LANGDON FOR FAIRFIELD

Dryer Cocktail Ottoman

Standard Pillows: N/A **Finish Req:** Y

Standard Cushions: High Resiliency 30 **Standard Finish:**

COM: 4.25 yards **COL:** 72 square feet

Width: 52.5 **Depth:** 30.5 **Height:** 20

AH: 0 **SH:** 0 **SD:** 0 **IW:** 0

Weight: 72 lbs **Cube:** 50.95

D	E	F	G	H	J	K COM	L	M	N	O	P	Q	R	S	T	U	(# above U) *	S Nail	M Nail
2100	2115	2130	2145	2160	2175	2190	2205	2220	2235	2250	2265	2280	2295	2310	2325	2340	15 (Riser) + 2340 (U)	60	N/A
Leather 1 3030		Leather 2 3150		Leather 3 3270		Leather 4 3390		Leather 5 3510		Leather 6 3630		Leather 8 4620		COL 2220		S Nail 60		M Nail N/A	

Upholstery

**Pillows are not available on leather SKUs*

Fabric SKU: **6603-20** Leather SKU: **L-6603-20**

LIBBY LANGDON FOR FAIRFIELD

Edgemere Cocktail Ottoman

Standard Pillows: N/A **Finish Req:** Y

Standard Cushions: High Resiliency 40 **Standard Finish:**

COM: 2.5 yards **COL:** 45 square feet

Features a biscuit tufted top and Brushed Brass ferrules

Width: 53 **Depth:** 31 **Height:** 18

AH: 0 **SH:** 0 **SD:** 0 **IW:** 0

Weight: 78 lbs **Cube:** 29.1

D	E	F	G	H	J	K COM	L	M	N	O	P	Q	R	S	T	U	(# above U) *	S Nail	M Nail
2010	2022	2034	2046	2058	2070	2082	2094	2106	2118	2130	2142	2154	2166	2178	2190	2202	12 (Riser) + 2202 (U)	45	N/A
Leather 1		Leather 2		Leather 3		Leather 4		Leather 5		Leather 6		Leather 8		COL		S Nail		M Nail	
2685		2760		2835		2910		2985		3060		3690		2106		45		N/A	

Fabric SKU: **6604-20-2** Leather SKU: **L-6604-20-2**

LIBBY LANGDON FOR FAIRFIELD

Sheldon Ottoman

Standard Pillows: N/A **Finish Req:** N

Standard Cushions: High Resiliency 40 **Standard Finish:** Nickel

COM: 1.25 yards **COL:** 23 square feet

Width: 14.5 **Depth:** 14.5 **Height:** 11

AH: 0 **SH:** 0 **SD:** 0 **IW:** 0

Weight: 9 lbs **Cube:** 10.77

D	E	F	G	H	J	K COM	L	M	N	O	P	Q	R	S	T	U	(# above U) *	S Nail	M Nail
750	756	762	768	774	780	786	792	798	804	810	816	822	828	834	840	846	6 (Riser) + 846 (U)	N/A	N/A
Leather 1		Leather 2		Leather 3		Leather 4		Leather 5		Leather 6		Leather 8		COL		S Nail		M Nail	
1185		1230		1275		1320		1365		1410		1725		798		N/A		N/A	

Fabric SKU: **6604-20-6** Leather SKU: **L-6604-20-6**

LIBBY LANGDON FOR FAIRFIELD

Sheldon Ottoman

Standard Pillows: N/A **Finish Req:** N

Standard Cushions: High Resiliency 40 **Standard Finish:** Brushed Brass

COM: 1.25 yards **COL:** 23 square feet

Width: 14.5 **Depth:** 14.5 **Height:** 11

AH: 0 **SH:** 0 **SD:** 0 **IW:** 0

Weight: 9 lbs **Cube:** 10.77

D	E	F	G	H	J	K COM	L	M	N	O	P	Q	R	S	T	U	(# above U) *	S Nail	M Nail
750	756	762	768	774	780	786	792	798	804	810	816	822	828	834	840	846	6 (Riser) + 846 (U)	N/A	N/A
Leather 1		Leather 2		Leather 3		Leather 4		Leather 5		Leather 6		Leather 8		COL		S Nail		M Nail	
1185		1230		1275		1320		1365		1410		1725		798		N/A		N/A	

Fabric SKU: **6612-20** Leather SKU: **L-6612-20**

LIBBY LANGDON FOR FAIRFIELD

Dryer Ottoman

Standard Pillows: N/A **Finish Req:** Y

Standard Cushions: High Resiliency 30 **Standard Finish:**

COM: 2 yards **COL:** 34.2 square feet

Width: 20.5 **Depth:** 20.5 **Height:** 20

AH: 0 **SH:** 0 **SD:** 0 **IW:** 0

Weight: 23 lbs **Cube:** 10.77

D	E	F	G	H	J	K COM	L	M	N	O	P	Q	R	S	T	U	(# above U) *	S Nail	M Nail
1275	1281	1287	1293	1299	1305	1311	1317	1323	1329	1335	1341	1347	1353	1359	1365	1371	6 (Riser) + 1371 (U)	30	N/A
Leather 1		Leather 2		Leather 3		Leather 4		Leather 5		Leather 6		Leather 8		COL		S Nail		M Nail	
2085		2145		2205		2265		2325		2385		2865		1323		30		N/A	

Fabric SKU: **6612-36** Leather SKU: **N/A**

LIBBY LANGDON FOR FAIRFIELD

Dryer Ottoman

Standard Pillows: N/A **Finish Req:** Y

Standard Cushions: High Resiliency 30 **Standard Finish:**

COM: 3.75 yards **COL:** N/A

Width: 36.5 **Depth:** 36.5 **Height:** 20

AH: 0 **SH:** 0 **SD:** 0 **IW:** 0

Weight: 58 lbs **Cube:** 15.41

D	E	F	G	H	J	K COM	L	M	N	O	P	Q	R	S	T	U	(# above U) *	S Nail	M Nail
1710	1722	1734	1746	1758	1770	1782	1794	1806	1818	1830	1842	1854	1866	1878	1890	1902	12 (Riser) + 1902 (U)	45	N/A
Leather 1		Leather 2		Leather 3		Leather 4		Leather 5		Leather 6		Leather 8		COL		S Nail		M Nail	
N/A		N/A		N/A		N/A		N/A		N/A		N/A		N/A		N/A		N/A	

Fabric SKU: **6612-44** Leather SKU: **N/A**

LIBBY LANGDON FOR FAIRFIELD

Dryer Ottoman

Standard Pillows: N/A **Finish Req:** Y

Standard Cushions: High Resiliency 30 **Standard Finish:**

COM: 5.25 yards **COL:** N/A

Width: 44.5 **Depth:** 44.5 **Height:** 20

AH: 0 **SH:** 0 **SD:** 0 **IW:** 0

Weight: 84 lbs **Cube:** 28.93

D	E	F	G	H	J	K COM	L	M	N	O	P	Q	R	S	T	U	(# above U) *	S Nail	M Nail
1920	1935	1950	1965	1980	1995	2010	2025	2040	2055	2070	2085	2100	2115	2130	2145	2160	15 (Riser) + 2160 (U)	60	N/A
Leather 1		Leather 2		Leather 3		Leather 4		Leather 5		Leather 6		Leather 8		COL		S Nail		M Nail	
N/A		N/A		N/A		N/A		N/A		N/A		N/A		N/A		N/A		N/A	

Upholstery

**Pillows are not available on leather SKUs*

Fabric SKU: **6612-52** Leather SKU: **N/A**

LIBBY LANGDON FOR FAIRFIELD

Dryer Ottoman

Standard Pillows: N/A Finish Req: Y

Standard Cushions: High Resiliency 30 Standard Finish:

COM: 4.25 yards COL: N/A

Width: 52.5 Depth: 30.5 Height: 20

AH: 0 SH: 0 SD: 0 IW: 0

Weight: 72 lbs Cube: 18.53

D	E	F	G	H	J	K COM	L	M	N	O	P	Q	R	S	T	U	(# above U) *	S Nail	M Nail
2010	2022	2034	2046	2058	2070	2082	2094	2106	2118	2130	2142	2154	2166	2178	2190	2202	12 (Riser) + 2202 (U)	60	N/A
Leather 1 N/A		Leather 2 N/A		Leather 3 N/A		Leather 4 N/A		Leather 5 N/A		Leather 6 N/A		Leather 8 N/A		COL N/A		S Nail N/A		M Nail N/A	

Fabric SKU: **6651-10-6** Leather SKU: **L-6651-10-6**

LIBBY LANGDON FOR FAIRFIELD

Laurel Bench

Standard Pillows: N/A Finish Req: N

Standard Cushions: High Resiliency 30 Standard Finish: Brushed Brass

COM: 2 yards COL: 34.2 square feet

Width: 47 Depth: 19.5 Height: 22

AH: 0 SH: 0 SD: 0 IW: 0

Weight: 36 lbs Cube: 15.26

D	E	F	G	H	J	K COM	L	M	N	O	P	Q	R	S	T	U	(# above U) *	S Nail	M Nail
1560	1569	1578	1587	1596	1605	1614	1623	1632	1641	1650	1659	1668	1677	1686	1695	1704	9 (Riser) + 1704 (U)	N/A	N/A
Leather 1 2010		Leather 2 2070		Leather 3 2130		Leather 4 2190		Leather 5 2250		Leather 6 2310		Leather 8 2790		COL 1632		S Nail N/A		M Nail N/A	

Fabric SKU: **6652-10** Leather SKU: **L-6652-10**

LIBBY LANGDON FOR FAIRFIELD

Carrington Bench

Standard Pillows: N/A Finish Req: N

Standard Cushions: High Resiliency 40 Standard Finish: Sheer Dove

COM: 2 yards COL: 34.2 square feet

Features a polished nickel frame and a wooden magazine rack finished in Sheer Dove.

Width: 48 Depth: 16 Height: 19

AH: 0 SH: 0 SD: 0 IW: 0

Weight: 38 lbs Cube: 23.16

D	E	F	G	H	J	K COM	L	M	N	O	P	Q	R	S	T	U	(# above U) *	S Nail	M Nail
2070	2076	2082	2088	2094	2100	2106	2112	2118	2124	2130	2136	2142	2148	2154	2160	2166	6 (Riser) + 2166 (U)	N/A	N/A
Leather 1 2475		Leather 2 2535		Leather 3 2595		Leather 4 2655		Leather 5 2715		Leather 6 2775		Leather 8 3255		COL 2118		S Nail N/A		M Nail N/A	

Fabric SKU: **6653-10-6** Leather SKU: **L-6653-10-6**

LIBBY LANGDON FOR FAIRFIELD

Laurel Ottoman

Standard Pillows: N/A Finish Req: N

Standard Cushions: High Resiliency 40 Standard Finish: Brushed Brass

COM: 2.75 yards COL: 45 square feet

Width: 62.75 Depth: 18.5 Height: 22

AH: 0 SH: 0 SD: 0 IW: 0

Weight: 33 lbs Cube: 14.77

D	E	F	G	H	J	K COM	L	M	N	O	P	Q	R	S	T	U	(# above U) *	S Nail	M Nail
1635	1644	1653	1662	1671	1680	1689	1698	1707	1716	1725	1734	1743	1752	1761	1770	1779	9 (Riser) + 1779 (U)	N/A	N/A
Leather 1 2280		Leather 2 2355		Leather 3 2430		Leather 4 2505		Leather 5 2580		Leather 6 2655		Leather 8 3285		COL 1707		S Nail N/A		M Nail N/A	

Fabric SKU: **6765-C7-2** Leather SKU: **L-6765-C7-2**

LIBBY LANGDON FOR FAIRFIELD

Jessup Counter Stool

Standard Pillows: N/A Finish Req: N

Standard Cushions: High Resiliency 40 Standard Finish: Nickel

COM: 2 yards COL: 34.2 square feet

Width: 19 Depth: 19 Height: 26.25

AH: 0 SH: 26.25 SD: 19 IW: 19

Weight: 20 lbs Cube: 15.74

D	E	F	G	H	J	K COM	L	M	N	O	P	Q	R	S	T	U	(# above U) *	S Nail	M Nail
1497	1506	1515	1524	1533	1542	1551	1560	1569	1578	1587	1596	1605	1614	1623	1632	1641	9 (Riser) + 1641 (U)	N/A	N/A
Leather 1 1980		Leather 2 2040		Leather 3 2100		Leather 4 2160		Leather 5 2220		Leather 6 2280		Leather 8 2760		COL 1569		S Nail N/A		M Nail N/A	

Fabric SKU: **7000-01**

Leather SKU: **L-7000-01**

Huxley Lounge Chair

Standard Pillows: N/A Finish Req: Y

Standard Cushions: Endurance Standard Finish:

COM: 5.5 yards COL: 90 square feet

Moisture Barrier Standard

Width: 29.5 Depth: 33 Height: 34.5

AH: 23 SH: 18.75 SD: 21 IW: 22.5

Weight: 51 lbs Cube: 19.43

D	E	F	G	H	J	K COM	L	M	N	O	P	Q	R	S	T	U	(# above U) *	S Nail	M Nail
2175	2193	2211	2229	2247	2265	2283	2301	2319	2337	2355	2373	2391	2409	2427	2445	2463	18 (Riser) + 2463 (U)	105	120
Leather 1 3150		Leather 2 3285		Leather 3 3420		Leather 4 3555		Leather 5 3690		Leather 6 3825		Leather 8 5070		COL 2319		S Nail 105		M Nail 120	

Upholstery

**Pillows are not available on leather SKUs*

Fabric SKU: **7000-50**

Leather SKU: **L-7000-50**

Standard Pillows: N/A **Finish Req:** Y

Standard Cushions: Endurance **Standard Finish:**

COM: 13.25 yards **COL:** 203 square feet

Moisture Barrier Standard

Huxley Sofa

Width: 86 **Depth:** 32.5 **Height:** 34.5

AH: 23 **SH:** 19.5 **SD:** 21 **IW:** 77.25

Weight: 111 lbs **Cube:** 55.8

D	E	F	G	H	J	K COM	L	M	N	O	P	Q	R	S	T	U	(# above U) *	S Nail	M Nail
3450	3489	3528	3567	3606	3645	3684	3723	3762	3801	3840	3879	3918	3957	3996	4035	4074	39 (Riser) + 4074 (U)	150	165
Leather 1 5385		Leather 2 5700		Leather 3 6015		Leather 4 6330		Leather 5 6645		Leather 6 6960		Leather 8 9750		COL 3762		S Nail 150		M Nail 165	

Fabric SKU: **7000-70**

Leather SKU: **L-7000-70**

Standard Pillows: N/A **Finish Req:** Y

Standard Cushions: Endurance **Standard Finish:**

COM: 10.5 yards **COL:** 158 square feet

Moisture Barrier Standard

Huxley Loveseat

Width: 75.5 **Depth:** 32.5 **Height:** 34.5

AH: 23 **SH:** 19.5 **SD:** 21 **IW:** 67.5

Weight: 106 lbs **Cube:** 48.98

D	E	F	G	H	J	K COM	L	M	N	O	P	Q	R	S	T	U	(# above U) *	S Nail	M Nail
3150	3180	3210	3240	3270	3300	3330	3360	3390	3420	3450	3480	3510	3540	3570	3600	3630	30 (Riser) + 3630 (U)	135	150
Leather 1 4725		Leather 2 4965		Leather 3 5205		Leather 4 5445		Leather 5 5685		Leather 6 5925		Leather 8 8100		COL 3390		S Nail 135		M Nail 150	

Fabric SKU: **7001-01**

Leather SKU: **L-7001-01**

Standard Pillows: N/A **Finish Req:** Y

Standard Cushions: High Resiliency 35 **Standard Finish:**

COM: 4.75 yards **COL:** 90 square feet

Moisture Barrier Standard

Venus Lounge Chair

Width: 29.25 **Depth:** 32 **Height:** 31.5

AH: 24.25 **SH:** 19.25 **SD:** 20.25 **IW:** 23

Weight: 0 lbs **Cube:** 17.06

D	E	F	G	H	J	K COM	L	M	N	O	P	Q	R	S	T	U	(# above U) *	S Nail	M Nail
2025	2040	2055	2070	2085	2100	2115	2130	2145	2160	2175	2190	2205	2220	2235	2250	2265	15 (Riser) + 2265 (U)	45	60
Leather 1 2985		Leather 2 3120		Leather 3 3255		Leather 4 3390		Leather 5 3525		Leather 6 3660		Leather 8 4905		COL 2145		S Nail 45		M Nail 60	

Fabric SKU: **7003-01**

Leather SKU: **N/A**

Standard Pillows: N/A **Finish Req:** N

Standard Cushions: High Resiliency 30 **Standard Finish:**

COM: 5.5 yards **COL:** N/A

Our Coco Lounge and Swivel Chair series are standard with a prefinished base in black. No finish options are available.

Coco Lounge Chair

Width: 31 **Depth:** 35.5 **Height:** 29.5

AH: 24.75 **SH:** 18.25 **SD:** 21 **IW:** 23

Weight: 67 lbs **Cube:** 18.78

D	E	F	G	H	J	K COM	L	M	N	O	P	Q	R	S	T	U	(# above U) *	S Nail	M Nail
1950	1968	1986	2004	2022	2040	2058	2076	2094	2112	2130	2148	2166	2184	2202	2220	2238	18 (Riser) + 2238 (U)	75	90
Leather 1 N/A		Leather 2 N/A		Leather 3 N/A		Leather 4 N/A		Leather 5 N/A		Leather 6 N/A		Leather 8 N/A		COL N/A		S Nail N/A		M Nail N/A	

Fabric SKU: **7003-31**

Leather SKU: **N/A**

Standard Pillows: N/A **Finish Req:** N

Standard Cushions: High Resiliency 30 **Standard Finish:**

COM: 5.5 yards **COL:** N/A

Our Coco Lounge and Swivel Chair series are standard with a prefinished base in black. No finish options are available.

Coco Swivel Chair

Width: 31 **Depth:** 35.5 **Height:** 29.5

AH: 24.75 **SH:** 18.25 **SD:** 21 **IW:** 23

Weight: 67 lbs **Cube:** 18.78

D	E	F	G	H	J	K COM	L	M	N	O	P	Q	R	S	T	U	(# above U) *	S Nail	M Nail
2025	2043	2061	2079	2097	2115	2133	2151	2169	2187	2205	2223	2241	2259	2277	2295	2313	18 (Riser) + 2313 (U)	75	90
Leather 1 N/A		Leather 2 N/A		Leather 3 N/A		Leather 4 N/A		Leather 5 N/A		Leather 6 N/A		Leather 8 N/A		COL N/A		S Nail N/A		M Nail N/A	

Fabric SKU: **7003-77**

Leather SKU: **N/A**

Standard Pillows: N/A **Finish Req:** Y

Standard Cushions: High Resiliency 30 **Standard Finish:**

COM: 7.5 yards **COL:** N/A

Coco Demi Sofa

Width: 76.5 **Depth:** 32.5 **Height:** 29.25

AH: 25.25 **SH:** 18.25 **SD:** 21.5 **IW:** 69.25

Weight: 131 lbs **Cube:** 42.08

D	E	F	G	H	J	K COM	L	M	N	O	P	Q	R	S	T	U	(# above U) *	S Nail	M Nail
2700	2721	2742	2763	2784	2805	2826	2847	2868	2889	2910	2931	2952	2973	2994	3015	3036	21 (Riser) + 3036 (U)	120	135
Leather 1 N/A		Leather 2 N/A		Leather 3 N/A		Leather 4 N/A		Leather 5 N/A		Leather 6 N/A		Leather 8 N/A		COL N/A		S Nail N/A		M Nail N/A	

Upholstery

**Pillows are not available on leather SKUs*

Fabric SKU: **7003-88**

Leather SKU: **N/A**

Standard Pillows: N/A **Finish Req:** Y

Standard Cushions: High Resiliency 30 **Standard Finish:**

COM: 8.25 yards **COL:** N/A

Coco Sofa

Width: 87.5 **Depth:** 32.5 **Height:** 29.25

AH: 25.25 **SH:** 18.25 **SD:** 21.5 **IW:** 80.25

Weight: 141 lbs **Cube:** 48.13

D	E	F	G	H	J	K COM	L	M	N	O	P	Q	R	S	T	U	(# above U) *	S Nail	M Nail
2850	2874	2898	2922	2946	2970	2994	3018	3042	3066	3090	3114	3138	3162	3186	3210	3234	24 (Riser) + 3234 (U)	120	135
Leather 1 N/A		Leather 2 N/A		Leather 3 N/A		Leather 4 N/A		Leather 5 N/A		Leather 6 N/A		Leather 8 N/A		COL N/A		S Nail N/A		M Nail N/A	

Fabric SKU: **7003-98**

Leather SKU: **N/A**

Standard Pillows: N/A **Finish Req:** Y

Standard Cushions: High Resiliency 30 **Standard Finish:**

COM: 9 yards **COL:** N/A

Coco Grande Sofa

Width: 98 **Depth:** 32.5 **Height:** 29.25

AH: 25.25 **SH:** 18.25 **SD:** 21.5 **IW:** 90.25

Weight: 151 lbs **Cube:** 53.91

D	E	F	G	H	J	K COM	L	M	N	O	P	Q	R	S	T	U	(# above U) *	S Nail	M Nail
3000	3027	3054	3081	3108	3135	3162	3189	3216	3243	3270	3297	3324	3351	3378	3405	3432	27 (Riser) + 3432 (U)	135	150
Leather 1 N/A		Leather 2 N/A		Leather 3 N/A		Leather 4 N/A		Leather 5 N/A		Leather 6 N/A		Leather 8 N/A		COL N/A		S Nail N/A		M Nail N/A	

Fabric SKU: **7004-01-2**

Leather SKU: **L-7004-01-2**

Standard Pillows: N/A **Finish Req:** N

Standard Cushions: Endurance **Standard Finish:** Nickel

COM: 4.5 yards **COL:** 79 square feet

Features a Nickel Metal base. Moisture Barrier Standard.

Zsa Zsa Lounge Chair

Nickel Finish

Width: 30.5 **Depth:** 33 **Height:** 29.5

AH: 24.25 **SH:** 18.5 **SD:** 23.5 **IW:** 21.5

Weight: 66 lbs **Cube:** 17.18

D	E	F	G	H	J	K COM	L	M	N	O	P	Q	R	S	T	U	(# above U) *	S Nail	M Nail
2325	2340	2355	2370	2385	2400	2415	2430	2445	2460	2475	2490	2505	2520	2535	2550	2565	15 (Riser) + 2565 (U)	N/A	N/A
Leather 1 3225		Leather 2 3345		Leather 3 3465		Leather 4 3585		Leather 5 3705		Leather 6 3825		Leather 8 4920		COL 2445		S Nail N/A		M Nail N/A	

Fabric SKU: **7004-01-6**

Leather SKU: **L-7004-01-6**

Standard Pillows: N/A **Finish Req:** N

Standard Cushions: Endurance **Standard Finish:** Brushed Brass

COM: 4.5 yards **COL:** 79 square feet

Features a Nickel Metal base. Moisture Barrier Standard.

Zsa Zsa Lounge Chair

Brushed Brass Finish

Width: 30.5 **Depth:** 33 **Height:** 29.5

AH: 24.25 **SH:** 18.5 **SD:** 23.5 **IW:** 21.5

Weight: 66 lbs **Cube:** 17.18

D	E	F	G	H	J	K COM	L	M	N	O	P	Q	R	S	T	U	(# above U) *	S Nail	M Nail
2325	2340	2355	2370	2385	2400	2415	2430	2445	2460	2475	2490	2505	2520	2535	2550	2565	15 (Riser) + 2565 (U)	N/A	N/A
Leather 1 3225		Leather 2 3345		Leather 3 3465		Leather 4 3585		Leather 5 3705		Leather 6 3825		Leather 8 4920		COL 2445		S Nail N/A		M Nail N/A	

Fabric SKU: **7008-50**

Leather SKU: **L-7008-50**

Standard Pillows: N/A **Finish Req:** Y

Standard Cushions: Endurance **Standard Finish:**

COM: 10.25 yards **COL:** 180 square feet

Includes (2) 24.75 x 13 box border arm pillows attached with tie-downs. Moisture Barrier Standard

Nigel Sofa

Width: 77.5 **Depth:** 30 **Height:** 31

AH: 27.25 **SH:** 19 **SD:** 25 **IW:** 51

Weight: 106 lbs **Cube:** 41.71

D	E	F	G	H	J	K COM	L	M	N	O	P	Q	R	S	T	U	(# above U) *	S Nail	M Nail
2850	2880	2910	2940	2970	3000	3030	3060	3090	3120	3150	3180	3210	3240	3270	3300	3330	30 (Riser) + 3330 (U)	75	N/A
Leather 1 4950		Leather 2 5220		Leather 3 5490		Leather 4 5760		Leather 5 6030		Leather 6 6300		Leather 8 8775		COL 3090		S Nail 75		M Nail N/A	

Fabric SKU: **7401-01**

Leather SKU: **L-7401-01**

Standard Pillows: N/A **Finish Req:** Y

Standard Cushions: Classic Plush **Standard Finish:**

COM: 6.75 yards **COL:** 119 square feet

Capelli Wing Chair

Width: 34.25 **Depth:** 33.5 **Height:** 47.5

AH: 25.5 **SH:** 22.5 **SD:** 20 **IW:** 21

Weight: 50 lbs **Cube:** 31.53

D	E	F	G	H	J	K COM	L	M	N	O	P	Q	R	S	T	U	(# above U) *	S Nail	M Nail
2685	2706	2727	2748	2769	2790	2811	2832	2853	2874	2895	2916	2937	2958	2979	3000	3021	21 (Riser) + 3021 (U)	Std.	N/A
Leather 1 4125		Leather 2 4305		Leather 3 4485		Leather 4 4665		Leather 5 4845		Leather 6 5025		Leather 8 6660		COL 2853		S Nail Std.		M Nail N/A	

Upholstery

**Pillows are not available on leather SKUs*

Fabric SKU: **7404-01**

Leather SKU: **N/A**

Standard Pillows: N/A Finish Req: Y

Standard Cushions: Classic Plush Standard Finish:

COM: 6.5 yards COL: N/A

Solar Lounge Chair

Width: 26.5 Depth: 36.5 Height: 36

AH: 24 SH: 19 SD: 20.5 IW: 21.5

Weight: 50 lbs Cube: 20.15

D	E	F	G	H	J	K COM	L	M	N	O	P	Q	R	S	T	U	(# above U) *	S Nail	M Nail
2625	2643	2661	2679	2697	2715	2733	2751	2769	2787	2805	2823	2841	2859	2877	2895	2913	18 (Riser) + 2913 (U)	N/A	N/A
Leather 1 N/A		Leather 2 N/A		Leather 3 N/A		Leather 4 N/A		Leather 5 N/A		Leather 6 N/A		Leather 8 N/A		COL N/A		S Nail N/A		M Nail N/A	

Fabric SKU: **7407-01**

Leather SKU: **N/A**

Standard Pillows: N/A Finish Req: Y

Standard Cushions: High Resiliency 30 Standard Finish:

COM: 5.25 yards COL: N/A

Gwynne Occasional Chair

Width: 27 Depth: 33.75 Height: 37.75

AH: 25.25 SH: 19 SD: 19.5 IW: 23.25

Weight: 62 lbs Cube: 23.89

D	E	F	G	H	J	K COM	L	M	N	O	P	Q	R	S	T	U	(# above U) *	S Nail	M Nail
2775	2790	2805	2820	2835	2850	2865	2880	2895	2910	2925	2940	2955	2970	2985	3000	3015	15 (Riser) + 3015 (U)	N/A	N/A
Leather 1 N/A		Leather 2 N/A		Leather 3 N/A		Leather 4 N/A		Leather 5 N/A		Leather 6 N/A		Leather 8 N/A		COL N/A		S Nail N/A		M Nail N/A	

Fabric SKU: **8128-99**

Leather SKU: **N/A**

Standard Pillows: N/A Finish Req: N

Standard Cushions: N/A Standard Finish:

COM: N/A yards COL: N/A

Morchana Marble Top with fretwork metal base

Pashmina Console

Width: 76 Depth: 15 Height: 38

AH: 0 SH: 0 SD: 0 IW: 0

Weight: 74 lbs Cube: 25.06

D	E	F	G	H	J	K COM	L	M	N	O	P	Q	R	S	T	U	(# above U) *	S Nail	M Nail
3297	N/A	N/A	N/A	N/A	N/A	N/A	N/A	N/A	N/A	N/A	N/A	N/A	N/A	N/A	N/A	N/A	N/A (Riser) + N/A (U)	N/A	N/A
Leather 1 N/A		Leather 2 N/A		Leather 3 N/A		Leather 4 N/A		Leather 5 N/A		Leather 6 N/A		Leather 8 N/A		COL N/A		S Nail N/A		M Nail N/A	

Fabric SKU: **8202-04**

Leather SKU: **L-8202-04**

Standard Pillows: N/A Finish Req: N

Standard Cushions: High Resiliency 30 Standard Finish:

COM: 3.75 yards COL: 74 square feet

Heath Arm Chair

Width: 23 Depth: 24.25 Height: 33.5

AH: 25.5 SH: 20.5 SD: 19 IW: 18.5

Weight: 51 lbs Cube: 10.81

D	E	F	G	H	J	K COM	L	M	N	O	P	Q	R	S	T	U	(# above U) *	S Nail	M Nail
1305	1317	1329	1341	1353	1365	1377	1389	1401	1413	1425	1437	1449	1461	1473	1485	1497	12 (Riser) + 1497 (U)	N/A	N/A
Leather 1 2250		Leather 2 2370		Leather 3 2490		Leather 4 2610		Leather 5 2730		Leather 6 2850		Leather 8 3870		COL 1401		S Nail N/A		M Nail N/A	

Fabric SKU: **8202-A4**

Leather SKU: **L-8202-A4**

Standard Pillows: N/A Finish Req: N

Standard Cushions: High Resiliency 30 Standard Finish:

COM: 3.75 yards COL: 74 square feet

Heath Arm Chair

with four casters

Width: 23 Depth: 24.25 Height: 33.5

AH: 25.5 SH: 20.5 SD: 19 IW: 18.5

Weight: 51 lbs Cube: 10.81

D	E	F	G	H	J	K COM	L	M	N	O	P	Q	R	S	T	U	(# above U) *	S Nail	M Nail
1377	1389	1401	1413	1425	1437	1449	1461	1473	1485	1497	1509	1521	1533	1545	1557	1569	12 (Riser) + 1569 (U)	N/A	N/A
Leather 1 2325		Leather 2 2445		Leather 3 2565		Leather 4 2685		Leather 5 2805		Leather 6 2925		Leather 8 3945		COL 1473		S Nail N/A		M Nail N/A	

Fabric SKU: **8250-01**

Leather SKU: **L-8250-01**

Standard Pillows: N/A Finish Req: Y

Standard Cushions: High Resiliency 40 Standard Finish:

COM: 2.5 yards COL: 51 square feet

Phillips Occasional Chair

Width: 24.5 Depth: 26.5 Height: 38.5

AH: 26 SH: 18.5 SD: 19 IW: 18

Weight: 30 lbs Cube: 15.74

D	E	F	G	H	J	K COM	L	M	N	O	P	Q	R	S	T	U	(# above U) *	S Nail	M Nail
1380	1389	1398	1407	1416	1425	1434	1443	1452	1461	1470	1479	1488	1497	1506	1515	1524	9 (Riser) + 1524 (U)	Std.	15
Leather 1 1980		Leather 2 2055		Leather 3 2130		Leather 4 2205		Leather 5 2280		Leather 6 2355		Leather 8 3060		COL 1452		S Nail Std.		M Nail 15	

Upholstery

**Pillows are not available on leather SKUs*

Fabric SKU: **8250-A4**

Leather SKU: **L-8250-A4**

Standard Pillows: N/A Finish Req: Y

Standard Cushions: High Resiliency 40 Standard Finish:

COM: 2.5 yards COL: 51 square feet

Phillips Occasional Chair

Width: 23.5 Depth: 26.5 Height: 38.5

AH: 26 SH: 18.5 SD: 19 IW: 18

Weight: 35 lbs Cube: 15.74

D	E	F	G	H	J	K COM	L	M	N	O	P	Q	R	S	T	U	(# above U) *	S Nail	M Nail
1452	1461	1470	1479	1488	1497	1506	1515	1524	1533	1542	1551	1560	1569	1578	1587	1596	9 (Riser) + 1596 (U)	Std.	15
Leather 1 2070		Leather 2 2145		Leather 3 2220		Leather 4 2295		Leather 5 2370		Leather 6 2445		Leather 8 3150		COL 1524		S Nail Std.		M Nail 15	

Fabric SKU: **8309-04**

Leather SKU: **L-8309-04**

Standard Pillows: N/A Finish Req: Y

Standard Cushions: High Resiliency 40 Standard Finish:

COM: 1.75 yards COL: 34 square feet

Available with Stretchers: 8339-04

Brookfield Arm Chair

Width: 24.5 Depth: 25 Height: 39

AH: 28 SH: 19.5 SD: 18 IW: 21

Weight: 30 lbs Cube: 21.65

D	E	F	G	H	J	K COM	L	M	N	O	P	Q	R	S	T	U	(# above U) *	S Nail	M Nail
1440	1446	1452	1458	1464	1470	1476	1482	1488	1494	1500	1506	1512	1518	1524	1530	1536	6 (Riser) + 1536 (U)	N/A	N/A
Leather 1 1800		Leather 2 1860		Leather 3 1920		Leather 4 1980		Leather 5 2040		Leather 6 2100		Leather 8 2565		COL 1488		S Nail N/A		M Nail N/A	

Fabric SKU: **8319-01**

Leather SKU: **L-8319-01**

Standard Pillows: N/A Finish Req: Y

Standard Cushions: High Resiliency 30 Standard Finish:

COM: 2.75 yards COL: 45 square feet

Available with Stretchers: 8329-01

Carlin Side Chair

Width: 21 Depth: 24.5 Height: 36.5

AH: 0 SH: 21.5 SD: 21 IW: 0

Weight: 25 lbs Cube: 15.74

D	E	F	G	H	J	K COM	L	M	N	O	P	Q	R	S	T	U	(# above U) *	S Nail	M Nail
1215	1224	1233	1242	1251	1260	1269	1278	1287	1296	1305	1314	1323	1332	1341	1350	1359	9 (Riser) + 1359 (U)	45	60
Leather 1 1860		Leather 2 1935		Leather 3 2010		Leather 4 2085		Leather 5 2160		Leather 6 2235		Leather 8 2865		COL 1287		S Nail 45		M Nail 60	

Fabric SKU: **8322-01**

Leather SKU: **L-8322-01**

Standard Pillows: N/A Finish Req: Y

Standard Cushions: High Resiliency 40 Standard Finish:

COM: 2 yards COL: 34.2 square feet

Burton Occasional Chair

Width: 25.5 Depth: 25.5 Height: 33

AH: 26 SH: 20.5 SD: 20 IW: 20.5

Weight: 26 lbs Cube: 15.74

D	E	F	G	H	J	K COM	L	M	N	O	P	Q	R	S	T	U	(# above U) *	S Nail	M Nail
1395	1401	1407	1413	1419	1425	1431	1437	1443	1449	1455	1461	1467	1473	1479	1485	1491	6 (Riser) + 1491 (U)	Std.	N/A
Leather 1 1845		Leather 2 1905		Leather 3 1965		Leather 4 2025		Leather 5 2085		Leather 6 2145		Leather 8 2625		COL 1443		S Nail Std.		M Nail N/A	

Fabric SKU: **8326-05**

Leather SKU: **L-8326-05**

Standard Pillows: N/A Finish Req: Y

Standard Cushions: High Resiliency 40 Standard Finish:

COM: 1.25 yards COL: 19.8 square feet

Portsmouth Side Chair

Width: 20 Depth: 23 Height: 38

AH: 0 SH: 19.5 SD: 19 IW: 0

Weight: 20 lbs Cube: 15.74

D	E	F	G	H	J	K COM	L	M	N	O	P	Q	R	S	T	U	(# above U) *	S Nail	M Nail
1080	1086	1092	1098	1104	1110	1116	1122	1128	1134	1140	1146	1152	1158	1164	1170	1176	6 (Riser) + 1176 (U)	45	60
Leather 1 1350		Leather 2 1380		Leather 3 1410		Leather 4 1440		Leather 5 1470		Leather 6 1500		Leather 8 1770		COL 1128		S Nail 45		M Nail 60	

Fabric SKU: **8329-01**

Leather SKU: **L-8329-01**

Standard Pillows: N/A Finish Req: Y

Standard Cushions: High Resiliency 30 Standard Finish:

COM: 2.75 yards COL: 45 square feet

Ardmore Side Chair

Width: 21 Depth: 24.5 Height: 36.5

AH: 0 SH: 21.5 SD: 21 IW: 21

Weight: 25 lbs Cube: 15.74

D	E	F	G	H	J	K COM	L	M	N	O	P	Q	R	S	T	U	(# above U) *	S Nail	M Nail
1260	1269	1278	1287	1296	1305	1314	1323	1332	1341	1350	1359	1368	1377	1386	1395	1404	9 (Riser) + 1404 (U)	45	60
Leather 1 1890		Leather 2 1965		Leather 3 2040		Leather 4 2115		Leather 5 2190		Leather 6 2265		Leather 8 2895		COL 1332		S Nail 45		M Nail 60	

Upholstery

**Pillows are not available on leather SKUs*

Fabric SKU: **8329-07**

Leather SKU: **L-8329-07**

Standard Pillows: N/A Finish Req: Y

Standard Cushions: High Resiliency 30 Standard Finish:

COM: 2.75 yards COL: 45 square feet

Ardmore Bar Stool

Width: 20 Depth: 22.5 Height: 45.5

AH: 0 SH: 30 SD: 17.5 IW: 0

Weight: 35 lbs Cube: 19.6

D	E	F	G	H	J	K COM	L	M	N	O	P	Q	R	S	T	U	(# above U) *	S Nail	M Nail
1305	1314	1323	1332	1341	1350	1359	1368	1377	1386	1395	1404	1413	1422	1431	1440	1449	9 (Riser) + 1449 (U)	45	60
Leather 1 1980		Leather 2 2055		Leather 3 2130		Leather 4 2205		Leather 5 2280		Leather 6 2355		Leather 8 2985		COL 1377		S Nail 45		M Nail 60	

Fabric SKU: **8329-C7**

Leather SKU: **L-8329-C7**

Standard Pillows: N/A Finish Req: Y

Standard Cushions: High Resiliency 30 Standard Finish:

COM: 2.75 yards COL: 45 square feet

Ardmore Counter Stool

Width: 20 Depth: 22.5 Height: 42

AH: 0 SH: 26.5 SD: 17.5 IW: 0

Weight: 35 lbs Cube: 19.6

D	E	F	G	H	J	K COM	L	M	N	O	P	Q	R	S	T	U	(# above U) *	S Nail	M Nail
1305	1314	1323	1332	1341	1350	1359	1368	1377	1386	1395	1404	1413	1422	1431	1440	1449	9 (Riser) + 1449 (U)	45	60
Leather 1 1980		Leather 2 2055		Leather 3 2130		Leather 4 2205		Leather 5 2280		Leather 6 2355		Leather 8 2985		COL 1377		S Nail 45		M Nail 60	

Fabric SKU: **8337-01**

Leather SKU: **L-8337-01**

Standard Pillows: N/A Finish Req: Y

Standard Cushions: Ultra Plush Standard Finish:

COM: 4 yards COL: 67.5 square feet

Pierce Occasional Chair

Width: 26 Depth: 26.5 Height: 34

AH: 24 SH: 20.5 SD: 20.5 IW: 20

Weight: 35 lbs Cube: 21.65

D	E	F	G	H	J	K COM	L	M	N	O	P	Q	R	S	T	U	(# above U) *	S Nail	M Nail
1875	1887	1899	1911	1923	1935	1947	1959	1971	1983	1995	2007	2019	2031	2043	2055	2067	12 (Riser) + 2067 (U)	45	N/A
Leather 1 2775		Leather 2 2880		Leather 3 2985		Leather 4 3090		Leather 5 3195		Leather 6 3300		Leather 8 4230		COL 1971		S Nail 45		M Nail N/A	

Fabric SKU: **8339-04**

Leather SKU: **L-8339-04**

Standard Pillows: N/A Finish Req: Y

Standard Cushions: High Resiliency 40 Standard Finish:

COM: 1.75 yards COL: 34 square feet

Brookfield Arm Chair

Width: 24.5 Depth: 25 Height: 39

AH: 28 SH: 19.5 SD: 18 IW: 21

Weight: 30 lbs Cube: 21.65

D	E	F	G	H	J	K COM	L	M	N	O	P	Q	R	S	T	U	(# above U) *	S Nail	M Nail
1485	1491	1497	1503	1509	1515	1521	1527	1533	1539	1545	1551	1557	1563	1569	1575	1581	6 (Riser) + 1581 (U)	N/A	N/A
Leather 1 1845		Leather 2 1905		Leather 3 1965		Leather 4 2025		Leather 5 2085		Leather 6 2145		Leather 8 2610		COL 1533		S Nail N/A		M Nail N/A	

Fabric SKU: **8363-04**

Leather SKU: **L-8363-04**

Standard Pillows: N/A Finish Req: Y

Standard Cushions: High Resiliency 40 Standard Finish:

COM: 2 yards COL: 40 square feet

Hamlin Arm Chair

Width: 24.5 Depth: 23 Height: 38

AH: 24.5 SH: 20 SD: 17.5 IW: 20.5

Weight: 30 lbs Cube: 15.74

D	E	F	G	H	J	K COM	L	M	N	O	P	Q	R	S	T	U	(# above U) *	S Nail	M Nail
1236	1242	1248	1254	1260	1266	1272	1278	1284	1290	1296	1302	1308	1314	1320	1326	1332	6 (Riser) + 1332 (U)	45	60
Leather 1 1680		Leather 2 1740		Leather 3 1800		Leather 4 1860		Leather 5 1920		Leather 6 1980		Leather 8 2535		COL 1284		S Nail 45		M Nail 60	

Fabric SKU: **8363-05**

Leather SKU: **L-8363-05**

Standard Pillows: N/A Finish Req: Y

Standard Cushions: High Resiliency 40 Standard Finish:

COM: 2 yards COL: 34.2 square feet

Hamlin Side Chair

Width: 21.5 Depth: 23 Height: 37

AH: 0 SH: 19.5 SD: 18 IW: 21.5

Weight: 25 lbs Cube: 15.74

D	E	F	G	H	J	K COM	L	M	N	O	P	Q	R	S	T	U	(# above U) *	S Nail	M Nail
1170	1176	1182	1188	1194	1200	1206	1212	1218	1224	1230	1236	1242	1248	1254	1260	1266	6 (Riser) + 1266 (U)	45	N/A
Leather 1 1632		Leather 2 1692		Leather 3 1752		Leather 4 1812		Leather 5 1872		Leather 6 1932		Leather 8 2412		COL 1218		S Nail 45		M Nail N/A	

Upholstery

**Pillows are not available on leather SKUs*

Fabric SKU: **8363-A4**

Leather SKU: **L-8363-A4**

Standard Pillows: N/A Finish Req: Y

Standard Cushions: High Resiliency 40 Standard Finish:

COM: 2 yards COL: 34.2 square feet

Hamlin Arm Chair

Width: 24.5 Depth: 24 Height: 38

AH: 24.5 SH: 20 SD: 18.5 IW: 20.5

Weight: 30 lbs Cube: 15.74

D	E	F	G	H	J	K COM	L	M	N	O	P	Q	R	S	T	U	(# above U) *	S Nail	M Nail
1308	1314	1320	1326	1332	1338	1344	1350	1356	1362	1368	1374	1380	1386	1392	1398	1404	6 (Riser) + 1404 (U)	45	60
Leather 1 1770		Leather 2 1830		Leather 3 1890		Leather 4 1950		Leather 5 2010		Leather 6 2070		Leather 8 2550		COL 1356		S Nail 45		M Nail 60	

Fabric SKU: **8365-04**

Leather SKU: **L-8365-04**

Standard Pillows: N/A Finish Req: Y

Standard Cushions: High Resiliency 40 Standard Finish:

COM: 2 yards COL: 34 square feet

Jefferson Arm Chair

Width: 24.5 Depth: 23 Height: 38

AH: 24.5 SH: 20 SD: 17.5 IW: 20.5

Weight: 25 lbs Cube: 15.74

D	E	F	G	H	J	K COM	L	M	N	O	P	Q	R	S	T	U	(# above U) *	S Nail	M Nail
1125	1131	1137	1143	1149	1155	1161	1167	1173	1179	1185	1191	1197	1203	1209	1215	1221	6 (Riser) + 1221 (U)	45	60
Leather 1 1545		Leather 2 1605		Leather 3 1665		Leather 4 1725		Leather 5 1785		Leather 6 1845		Leather 8 2310		COL 1173		S Nail 45		M Nail 60	

Fabric SKU: **8365-A4**

Leather SKU: **L-8365-A4**

Standard Pillows: N/A Finish Req: Y

Standard Cushions: High Resiliency 40 Standard Finish:

COM: 2 yards COL: 34 square feet

Jefferson Arm Chair

Width: 24.5 Depth: 23 Height: 38

AH: 24.5 SH: 20 SD: 17.5 IW: 20.5

Weight: 25 lbs Cube: 15.74

D	E	F	G	H	J	K COM	L	M	N	O	P	Q	R	S	T	U	(# above U) *	S Nail	M Nail
1197	1203	1209	1215	1221	1227	1233	1239	1245	1251	1257	1263	1269	1275	1281	1287	1293	6 (Riser) + 1293 (U)	45	60
Leather 1 1620		Leather 2 1680		Leather 3 1740		Leather 4 1800		Leather 5 1860		Leather 6 1920		Leather 8 2385		COL 1245		S Nail 45		M Nail 60	

Fabric SKU: **8368-04**

Leather SKU: **L-8368-04**

Standard Pillows: N/A Finish Req: Y

Standard Cushions: High Resiliency 40 Standard Finish:

COM: 2 yards COL: 40 square feet

Bayfield Arm Chair

Width: 24.5 Depth: 27 Height: 40

AH: 26.5 SH: 20 SD: 19 IW: 21

Weight: 35 lbs Cube: 21.65

D	E	F	G	H	J	K COM	L	M	N	O	P	Q	R	S	T	U	(# above U) *	S Nail	M Nail
1125	1131	1137	1143	1149	1155	1161	1167	1173	1179	1185	1191	1197	1203	1209	1215	1221	6 (Riser) + 1221 (U)	N/A	N/A
Leather 1 1545		Leather 2 1605		Leather 3 1665		Leather 4 1725		Leather 5 1785		Leather 6 1845		Leather 8 2400		COL 1173		S Nail N/A		M Nail N/A	

Fabric SKU: **8368-A4**

Leather SKU: **L-8368-A4**

Standard Pillows: N/A Finish Req: Y

Standard Cushions: High Resiliency 40 Standard Finish:

COM: 2 yards COL: 40 square feet

Bayfield Arm Chair

Width: 24.5 Depth: 27 Height: 40

AH: 26.5 SH: 20 SD: 19 IW: 21

Weight: 35 lbs Cube: 21.65

D	E	F	G	H	J	K COM	L	M	N	O	P	Q	R	S	T	U	(# above U) *	S Nail	M Nail
1197	1203	1209	1215	1221	1227	1233	1239	1245	1251	1257	1263	1269	1275	1281	1287	1293	6 (Riser) + 1293 (U)	N/A	N/A
Leather 1 1620		Leather 2 1680		Leather 3 1740		Leather 4 1800		Leather 5 1860		Leather 6 1920		Leather 8 2475		COL 1245		S Nail N/A		M Nail N/A	

Fabric SKU: **8379-01**

Leather SKU: **L-8379-01**

Standard Pillows: N/A Finish Req: Y

Standard Cushions: High Resiliency 40 Standard Finish:

COM: 3.5 yards COL: 62 square feet

Ashton Occasional Chair

Width: 25.5 Depth: 29.5 Height: 38

AH: 23 SH: 19.5 SD: 19 IW: 18

Weight: 35 lbs Cube: 21.65

D	E	F	G	H	J	K COM	L	M	N	O	P	Q	R	S	T	U	(# above U) *	S Nail	M Nail
1650	1659	1668	1677	1686	1695	1704	1713	1722	1731	1740	1749	1758	1767	1776	1785	1794	9 (Riser) + 1794 (U)	60	75
Leather 1 2310		Leather 2 2415		Leather 3 2520		Leather 4 2625		Leather 5 2730		Leather 6 2835		Leather 8 3690		COL 1722		S Nail 60		M Nail 75	

Upholstery

**Pillows are not available on leather SKUs*

Fabric SKU: **8379-35**

Leather SKU: **L-8379-35**

Standard Pillows: N/A **Finish Req:** Y

Standard Cushions: High Resiliency 40 **Standard Finish:**

COM: 3.5 yards **COL:** 62 square feet
Standard with a gas lift.

Ashton Office Swivel Chair

Width: 25.5 **Depth:** 29.5 **Height:** 33

AH: 0 **SH:** 0 **SD:** 19 **IW:** 18

Weight: 55 lbs **Cube:** 21.65

D	E	F	G	H	J	K COM	L	M	N	O	P	Q	R	S	T	U	(# above U) *	S Nail	M Nail
1875	1887	1899	1911	1923	1935	1947	1959	1971	1983	1995	2007	2019	2031	2043	2055	2067	12 (Riser) + 2067 (U)	60	75
Leather 1 2640		Leather 2 2745		Leather 3 2850		Leather 4 2955		Leather 5 3060		Leather 6 3165		Leather 8 4020		COL 1971		S Nail 60		M Nail 75	

Fabric SKU: **8379-1N**

Leather SKU: **L-8379-1N**

Standard Pillows: N/A **Finish Req:** N

Standard Cushions: High Resiliency 40 **Standard Finish:** Nickel

COM: 3.5 yards **COL:** 62 square feet
Features Swivel Nickel Base with Casters

Ashton Task Chair

Width: 25 **Depth:** 27.75 **Height:** 39.75

AH: 21.5 **SH:** 20.75 **SD:** 18.75 **IW:** 18

Weight: 38 lbs **Cube:** 21.65

D	E	F	G	H	J	K COM	L	M	N	O	P	Q	R	S	T	U	(# above U) *	S Nail	M Nail
1800	1809	1818	1827	1836	1845	1854	1863	1872	1881	1890	1899	1908	1917	1926	1935	1944	9 (Riser) + 1944 (U)	60	75
Leather 1 2625		Leather 2 2730		Leather 3 2835		Leather 4 2940		Leather 5 3045		Leather 6 3150		Leather 8 4005		COL 1872		S Nail 60		M Nail 75	

Fabric SKU: **8379-2N**

Leather SKU: **L-8379-2N**

Standard Pillows: N/A **Finish Req:** N

Standard Cushions: High Resiliency 40 **Standard Finish:** Nickel

COM: 3.5 yards **COL:** 62 square feet
Features Stationary Nickel Plated Base with a gas cylinder.

Ashton Swivel Chair

Width: 25 **Depth:** 27.75 **Height:** 38.25

AH: 20 **SH:** 19.25 **SD:** 18.75 **IW:** 18

Weight: 38 lbs **Cube:** 21.65

D	E	F	G	H	J	K COM	L	M	N	O	P	Q	R	S	T	U	(# above U) *	S Nail	M Nail
1800	1809	1818	1827	1836	1845	1854	1863	1872	1881	1890	1899	1908	1917	1926	1935	1944	9 (Riser) + 1944 (U)	60	75
Leather 1 2625		Leather 2 2730		Leather 3 2835		Leather 4 2940		Leather 5 3045		Leather 6 3150		Leather 8 4005		COL 1872		S Nail 60		M Nail 75	

Fabric SKU: **8389-01**

Leather SKU: **L-8389-01**

Standard Pillows: N/A **Finish Req:** Y

Standard Cushions: High Resiliency 40 **Standard Finish:**

COM: 3.5 yards **COL:** 68 square feet

Clancy Occasional Chair

Width: 25.5 **Depth:** 29.5 **Height:** 38

AH: 23 **SH:** 19.5 **SD:** 19 **IW:** 18

Weight: 35 lbs **Cube:** 21.65

D	E	F	G	H	J	K COM	L	M	N	O	P	Q	R	S	T	U	(# above U) *	S Nail	M Nail
1650	1662	1674	1686	1698	1710	1722	1734	1746	1758	1770	1782	1794	1806	1818	1830	1842	12 (Riser) + 1842 (U)	60	75
Leather 1 2505		Leather 2 2610		Leather 3 2715		Leather 4 2820		Leather 5 2925		Leather 6 3030		Leather 8 3975		COL 1746		S Nail 60		M Nail 75	

Fabric SKU: **8389-35**

Leather SKU: **L-8389-35**

Standard Pillows: N/A **Finish Req:** Y

Standard Cushions: High Resiliency 40 **Standard Finish:**

COM: 3.5 yards **COL:** 68 square feet
Standard with a gas lift.

Clancy Office Swivel Chair

Width: 25.5 **Depth:** 29.5 **Height:** 33

AH: 0 **SH:** 0 **SD:** 19 **IW:** 18

Weight: 55 lbs **Cube:** 21.65

D	E	F	G	H	J	K COM	L	M	N	O	P	Q	R	S	T	U	(# above U) *	S Nail	M Nail
1980	1992	2004	2016	2028	2040	2052	2064	2076	2088	2100	2112	2124	2136	2148	2160	2172	12 (Riser) + 2172 (U)	60	75
Leather 1 2745		Leather 2 2850		Leather 3 2955		Leather 4 3060		Leather 5 3165		Leather 6 3270		Leather 8 4215		COL 2076		S Nail 60		M Nail 75	

Fabric SKU: **8403-04**

Leather SKU: **L-8403-04**

Standard Pillows: N/A **Finish Req:** Y

Standard Cushions: High Resiliency 40 **Standard Finish:**

COM: 3.25 yards **COL:** 53.1 square feet

Avilla Arm Chair

Width: 25 **Depth:** 26 **Height:** 39.5

AH: 23.5 **SH:** 20.5 **SD:** 18.5 **IW:** 17

Weight: 30 lbs **Cube:** 21.65

D	E	F	G	H	J	K COM	L	M	N	O	P	Q	R	S	T	U	(# above U) *	S Nail	M Nail
1500	1509	1518	1527	1536	1545	1554	1563	1572	1581	1590	1599	1608	1617	1626	1635	1644	9 (Riser) + 1644 (U)	N/A	N/A
Leather 1 2295		Leather 2 2385		Leather 3 2475		Leather 4 2565		Leather 5 2655		Leather 6 2745		Leather 8 3480		COL 1572		S Nail N/A		M Nail N/A	

Upholstery

**Pillows are not available on leather SKUs*

Fabric SKU: **8411-04**

Leather SKU: **L-8411-04**

Standard Pillows: N/A Finish Req: Y

Standard Cushions: High Resiliency 40 Standard Finish:

COM: 2 yards COL: 34 square feet

Plymouth Arm Chair

Width: 23 Depth: 23 Height: 36.5

AH: 26 SH: 19.5 SD: 17.5 IW: 19

Weight: 30 lbs Cube: 15.74

D	E	F	G	H	J	K COM	L	M	N	O	P	Q	R	S	T	U	(# above U) *	S Nail	M Nail
1230	1236	1242	1248	1254	1260	1266	1272	1278	1284	1290	1296	1302	1308	1314	1320	1326	6 (Riser) + 1326 (U)	45	N/A
Leather 1 1680		Leather 2 1740		Leather 3 1800		Leather 4 1860		Leather 5 1920		Leather 6 1980		Leather 8 2445		COL 1278		S Nail 45		M Nail N/A	

Fabric SKU: **8411-A4**

Leather SKU: **L-8411-A4**

Standard Pillows: N/A Finish Req: Y

Standard Cushions: High Resiliency 40 Standard Finish:

COM: 2 yards COL: 34.2 square feet

Plymouth Arm Chair

Width: 23 Depth: 23 Height: 36.5

AH: 26 SH: 19.5 SD: 17.5 IW: 19

Weight: 30 lbs Cube: 15.74

D	E	F	G	H	J	K COM	L	M	N	O	P	Q	R	S	T	U	(# above U) *	S Nail	M Nail
1302	1308	1314	1320	1326	1332	1338	1344	1350	1356	1362	1368	1374	1380	1386	1392	1398	6 (Riser) + 1398 (U)	45	60
Leather 1 1755		Leather 2 1815		Leather 3 1875		Leather 4 1935		Leather 5 1995		Leather 6 2055		Leather 8 2535		COL 1350		S Nail 45		M Nail 60	

Fabric SKU: **8444-04**

Leather SKU: **L-8444-04**

Standard Pillows: N/A Finish Req: Y

Standard Cushions: High Resiliency 40 Standard Finish:

COM: 2 yards COL: 40 square feet

Selby Arm Chair

Width: 24.5 Depth: 26.5 Height: 38.5

AH: 25 SH: 18.5 SD: 18.5 IW: 19.5

Weight: 30 lbs Cube: 21.09

D	E	F	G	H	J	K COM	L	M	N	O	P	Q	R	S	T	U	(# above U) *	S Nail	M Nail
1050	1056	1062	1068	1074	1080	1086	1092	1098	1104	1110	1116	1122	1128	1134	1140	1146	6 (Riser) + 1146 (U)	N/A	N/A
Leather 1 1485		Leather 2 1545		Leather 3 1605		Leather 4 1665		Leather 5 1725		Leather 6 1785		Leather 8 2340		COL 1098		S Nail N/A		M Nail N/A	

Fabric SKU: **8444-A4**

Leather SKU: **L-8444-A4**

Standard Pillows: N/A Finish Req: Y

Standard Cushions: High Resiliency 40 Standard Finish:

COM: 2 yards COL: 40 square feet

Selby Arm Chair

Width: 24.5 Depth: 26.5 Height: 38.5

AH: 25 SH: 18.5 SD: 18.5 IW: 19.5

Weight: 31 lbs Cube: 15.74

D	E	F	G	H	J	K COM	L	M	N	O	P	Q	R	S	T	U	(# above U) *	S Nail	M Nail
1122	1128	1134	1140	1146	1152	1158	1164	1170	1176	1182	1188	1194	1200	1206	1212	1218	6 (Riser) + 1218 (U)	N/A	N/A
Leather 1 1560		Leather 2 1620		Leather 3 1680		Leather 4 1740		Leather 5 1800		Leather 6 1860		Leather 8 2415		COL 1170		S Nail N/A		M Nail N/A	

Fabric SKU: **8484-04**

Leather SKU: **L-8484-04**

Standard Pillows: N/A Finish Req: Y

Standard Cushions: High Resiliency 40 Standard Finish:

COM: 2 yards COL: 45 square feet

Powell Arm Chair

Width: 23 Depth: 25 Height: 38

AH: 26 SH: 20 SD: 19.5 IW: 19.5

Weight: 35 lbs Cube: 15.74

D	E	F	G	H	J	K COM	L	M	N	O	P	Q	R	S	T	U	(# above U) *	S Nail	M Nail
1320	1326	1332	1338	1344	1350	1356	1362	1368	1374	1380	1386	1392	1398	1404	1410	1416	6 (Riser) + 1416 (U)	45	60
Leather 1 1785		Leather 2 1860		Leather 3 1935		Leather 4 2010		Leather 5 2085		Leather 6 2160		Leather 8 2790		COL 1368		S Nail 45		M Nail 60	

Fabric SKU: **8484-05**

Leather SKU: **L-8484-05**

Standard Pillows: N/A Finish Req: Y

Standard Cushions: High Resiliency 40 Standard Finish:

COM: 2 yards COL: 34.2 square feet

Powell Side Chair

Width: 23 Depth: 24 Height: 37.5

AH: 0 SH: 19.5 SD: 19.5 IW: 23.5

Weight: 30 lbs Cube: 15.74

D	E	F	G	H	J	K COM	L	M	N	O	P	Q	R	S	T	U	(# above U) *	S Nail	M Nail
1287	1293	1299	1305	1311	1317	1323	1329	1335	1341	1347	1353	1359	1365	1371	1377	1383	6 (Riser) + 1383 (U)	45	N/A
Leather 1 1755		Leather 2 1815		Leather 3 1875		Leather 4 1935		Leather 5 1995		Leather 6 2055		Leather 8 2535		COL 1335		S Nail 45		M Nail N/A	

Upholstery

**Pillows are not available on leather SKUs*

Fabric SKU: **8484-A4**

Leather SKU: **L-8484-A4**

Standard Pillows: N/A Finish Req: Y

Standard Cushions: High Resiliency 40 Standard Finish:

COM: 2 yards COL: 45 square feet

Powell Arm Chair

Width: 23 Depth: 25 Height: 38

AH: 26 SH: 20 SD: 19.5 IW: 19.5

Weight: 35 lbs Cube: 15.74

D	E	F	G	H	J	K COM	L	M	N	O	P	Q	R	S	T	U	(# above U) *	S Nail	M Nail
1392	1398	1404	1410	1416	1422	1428	1434	1440	1446	1452	1458	1464	1470	1476	1482	1488	6 (Riser) + 1488 (U)	45	60
Leather 1 1860		Leather 2 1935		Leather 3 2010		Leather 4 2085		Leather 5 2160		Leather 6 2235		Leather 8 2865		COL 1440		S Nail 45		M Nail 60	

Fabric SKU: **8486-04**

Leather SKU: **L-8486-04**

Standard Pillows: N/A Finish Req: Y

Standard Cushions: High Resiliency 40 Standard Finish:

COM: 2 yards COL: 40 square feet

Seward Arm Chair

Width: 23 Depth: 24.5 Height: 38

AH: 26.5 SH: 20.5 SD: 19 IW: 20

Weight: 30 lbs Cube: 15.74

D	E	F	G	H	J	K COM	L	M	N	O	P	Q	R	S	T	U	(# above U) *	S Nail	M Nail
1320	1326	1332	1338	1344	1350	1356	1362	1368	1374	1380	1386	1392	1398	1404	1410	1416	6 (Riser) + 1416 (U)	45	60
Leather 1 1770		Leather 2 1830		Leather 3 1890		Leather 4 1950		Leather 5 2010		Leather 6 2070		Leather 8 2625		COL 1368		S Nail 45		M Nail 60	

Fabric SKU: **8486-A4**

Leather SKU: **L-8486-A4**

Standard Pillows: N/A Finish Req: Y

Standard Cushions: High Resiliency 40 Standard Finish:

COM: 2 yards COL: 40 square feet

Seward Arm Chair

Width: 23 Depth: 24.5 Height: 38

AH: 26.5 SH: 20.5 SD: 19 IW: 20

Weight: 30 lbs Cube: 15.74

D	E	F	G	H	J	K COM	L	M	N	O	P	Q	R	S	T	U	(# above U) *	S Nail	M Nail
1392	1398	1404	1410	1416	1422	1428	1434	1440	1446	1452	1458	1464	1470	1476	1482	1488	6 (Riser) + 1488 (U)	45	60
Leather 1 1845		Leather 2 1905		Leather 3 1965		Leather 4 2025		Leather 5 2085		Leather 6 2145		Leather 8 2700		COL 1440		S Nail 45		M Nail 60	

Fabric SKU: **8499-04**

Leather SKU: **L-8499-04**

Standard Pillows: N/A Finish Req: Y

Standard Cushions: High Resiliency 40 Standard Finish:

COM: 1.75 yards COL: 40 square feet

Martine Arm Chair

Width: 23.5 Depth: 23 Height: 41.5

AH: 27 SH: 20 SD: 17.5 IW: 20

Weight: 30 lbs Cube: 15.74

D	E	F	G	H	J	K COM	L	M	N	O	P	Q	R	S	T	U	(# above U) *	S Nail	M Nail
1320	1326	1332	1338	1344	1350	1356	1362	1368	1374	1380	1386	1392	1398	1404	1410	1416	6 (Riser) + 1416 (U)	N/A	N/A
Leather 1 1710		Leather 2 1770		Leather 3 1830		Leather 4 1890		Leather 5 1950		Leather 6 2010		Leather 8 2565		COL 1368		S Nail N/A		M Nail N/A	

Fabric SKU: **8700-04**

Leather SKU: **L-8700-04**

Standard Pillows: N/A Finish Req: Y

Standard Cushions: High Resiliency 40 Standard Finish:

COM: 2.25 yards COL: 40 square feet

Preston Arm Chair

Width: 23.5 Depth: 23.5 Height: 38

AH: 25 SH: 19 SD: 19.5 IW: 20

Weight: 30 lbs Cube: 15.74

D	E	F	G	H	J	K COM	L	M	N	O	P	Q	R	S	T	U	(# above U) *	S Nail	M Nail
1050	1056	1062	1068	1074	1080	1086	1092	1098	1104	1110	1116	1122	1128	1134	1140	1146	6 (Riser) + 1146 (U)	45	60
Leather 1 1485		Leather 2 1545		Leather 3 1605		Leather 4 1665		Leather 5 1725		Leather 6 1785		Leather 8 2340		COL 1098		S Nail 45		M Nail 60	

Fabric SKU: **8700-11**

Leather SKU: **L-8700-11**

Standard Pillows: N/A Finish Req: Y

Standard Cushions: High Resiliency 40 Standard Finish:

COM: 2 yards COL: 34 square feet

Available in FairShield Plus Finishes Only. Warranted for stacking three high.

Preston Arm Stack Chair

Width: 24.5 Depth: 22.5 Height: 35

AH: 26 SH: 19 SD: 18.5 IW: 20.5

Weight: 23 lbs Cube: 15.74

D	E	F	G	H	J	K COM	L	M	N	O	P	Q	R	S	T	U	(# above U) *	S Nail	M Nail
1050	1056	1062	1068	1074	1080	1086	1092	1098	1104	1110	1116	1122	1128	1134	1140	1146	6 (Riser) + 1146 (U)	45	60
Leather 1 1485		Leather 2 1545		Leather 3 1605		Leather 4 1665		Leather 5 1725		Leather 6 1785		Leather 8 2250		COL 1098		S Nail 45		M Nail 60	

Upholstery

**Pillows are not available on leather SKUs*

Fabric SKU: **8700-A4**

Leather SKU: **L-8700-A4**

Standard Pillows: N/A Finish Req: Y

Standard Cushions: High Resiliency 40 Standard Finish:

COM: 2.25 yards COL: 40 square feet

Preston Arm Chair

Width: 23.5 Depth: 23.5 Height: 38

AH: 25 SH: 19 SD: 19.5 IW: 20

Weight: 30 lbs Cube: 15.74

D	E	F	G	H	J	K COM	L	M	N	O	P	Q	R	S	T	U	(# above U) *	S Nail	M Nail
1122	1128	1134	1140	1146	1152	1158	1164	1170	1176	1182	1188	1194	1200	1206	1212	1218	6 (Riser) + 1218 (U)	45	60
Leather 1 1560		Leather 2 1620		Leather 3 1680		Leather 4 1740		Leather 5 1800		Leather 6 1860		Leather 8 2415		COL 1170		S Nail 45		M Nail 60	

Fabric SKU: **8702-04**

Leather SKU: **L-8702-04**

Standard Pillows: N/A Finish Req: Y

Standard Cushions: High Resiliency 40 Standard Finish:

COM: 2 yards COL: 40 square feet

Spiro Arm Chair

Width: 23 Depth: 24 Height: 37.5

AH: 26.5 SH: 19 SD: 18.5 IW: 20.5

Weight: 30 lbs Cube: 15.74

D	E	F	G	H	J	K COM	L	M	N	O	P	Q	R	S	T	U	(# above U) *	S Nail	M Nail
1365	1371	1377	1383	1389	1395	1401	1407	1413	1419	1425	1431	1437	1443	1449	1455	1461	6 (Riser) + 1461 (U)	45	N/A
Leather 1 1845		Leather 2 1905		Leather 3 1965		Leather 4 2025		Leather 5 2085		Leather 6 2145		Leather 8 2700		COL 1413		S Nail 45		M Nail N/A	

Fabric SKU: **8705-04**

Leather SKU: **L-8705-04**

Standard Pillows: N/A Finish Req: Y

Standard Cushions: High Resiliency 40 Standard Finish:

COM: 2 yards COL: 40 square feet

Taunton Arm Chair

Width: 23 Depth: 23.5 Height: 39

AH: 25.5 SH: 19.5 SD: 18.5 IW: 19

Weight: 20 lbs Cube: 15.74

D	E	F	G	H	J	K COM	L	M	N	O	P	Q	R	S	T	U	(# above U) *	S Nail	M Nail
1320	1326	1332	1338	1344	1350	1356	1362	1368	1374	1380	1386	1392	1398	1404	1410	1416	6 (Riser) + 1416 (U)	45	N/A
Leather 1 1755		Leather 2 1815		Leather 3 1875		Leather 4 1935		Leather 5 1995		Leather 6 2055		Leather 8 2610		COL 1368		S Nail 45		M Nail N/A	

Fabric SKU: **8713-04**

Leather SKU: **L-8713-04**

Standard Pillows: N/A Finish Req: Y

Standard Cushions: High Resiliency 30 Standard Finish:

COM: 4.5 yards COL: 72.25 square feet

Maya Arm Chair

Width: 26 Depth: 28.5 Height: 42.5

AH: 27 SH: 20.5 SD: 18 IW: 18

Weight: 41 lbs Cube: 21.65

D	E	F	G	H	J	K COM	L	M	N	O	P	Q	R	S	T	U	(# above U) *	S Nail	M Nail
1716	1728	1740	1752	1764	1776	1788	1800	1812	1824	1836	1848	1860	1872	1884	1896	1908	12 (Riser) + 1908 (U)	45	60
Leather 1 2640		Leather 2 2760		Leather 3 2880		Leather 4 3000		Leather 5 3120		Leather 6 3240		Leather 8 4245		COL 1812		S Nail 45		M Nail 60	

Fabric SKU: **8718-05**

Leather SKU: **L-8718-05**

Standard Pillows: N/A Finish Req: Y

Standard Cushions: High Resiliency 40 Standard Finish:

COM: 2.25 yards COL: 38.7 square feet

Wallace Side Chair

Width: 22 Depth: 24.5 Height: 38.5

AH: 0 SH: 19.5 SD: 19.5 IW: 22

Weight: 30 lbs Cube: 15.74

D	E	F	G	H	J	K COM	L	M	N	O	P	Q	R	S	T	U	(# above U) *	S Nail	M Nail
1290	1296	1302	1308	1314	1320	1326	1332	1338	1344	1350	1356	1362	1368	1374	1380	1386	6 (Riser) + 1386 (U)	45	60
Leather 1 1815		Leather 2 1875		Leather 3 1935		Leather 4 1995		Leather 5 2055		Leather 6 2115		Leather 8 2655		COL 1338		S Nail 45		M Nail 60	

Fabric SKU: **8720-04**

Leather SKU: **L-8720-04**

Standard Pillows: N/A Finish Req: Y

Standard Cushions: High Resiliency 40 Standard Finish:

COM: 2.5 yards COL: 44 square feet

Albany Arm Chair

Width: 23 Depth: 23.5 Height: 31.5

AH: 25.5 SH: 19.5 SD: 20.5 IW: 18.5

Weight: 21 lbs Cube: 15.74

D	E	F	G	H	J	K COM	L	M	N	O	P	Q	R	S	T	U	(# above U) *	S Nail	M Nail
1350	1359	1368	1377	1386	1395	1404	1413	1422	1431	1440	1449	1458	1467	1476	1485	1494	9 (Riser) + 1494 (U)	45	60
Leather 1 1950		Leather 2 2025		Leather 3 2100		Leather 4 2175		Leather 5 2250		Leather 6 2325		Leather 8 2940		COL 1422		S Nail 45		M Nail 60	

Upholstery

**Pillows are not available on leather SKUs*

Fabric SKU: **8720-06**

Leather SKU: **L-8720-06**

Standard Pillows: N/A Finish Req: Y

Standard Cushions: High Resiliency 40 Standard Finish:

COM: 2.5 yards COL: 43.2 square feet

Albany Bar Stool

Width: 23 Depth: 23.5 Height: 42
 AH: 36 SH: 30 SD: 20.5 IW: 18.5
 Weight: 40 lbs Cube: 17.77

D	E	F	G	H	J	K COM	L	M	N	O	P	Q	R	S	T	U	(# above U) *	S Nail	M Nail
1650	1659	1668	1677	1686	1695	1704	1713	1722	1731	1740	1749	1758	1767	1776	1785	1794	9 (Riser) + 1794 (U)	45	60
Leather 1 2295		Leather 2 2370		Leather 3 2445		Leather 4 2520		Leather 5 2595		Leather 6 2670		Leather 8 3270		COL 1722		S Nail 45		M Nail 60	

Fabric SKU: **8720-C6**

Leather SKU: **L-8720-C6**

Standard Pillows: N/A Finish Req: Y

Standard Cushions: High Resiliency 40 Standard Finish:

COM: 2.5 yards COL: 43.2 square feet

Albany Counter Stool

Width: 23 Depth: 23.5 Height: 38
 AH: 32 SH: 26 SD: 20.5 IW: 18.5
 Weight: 35 lbs Cube: 15.74

D	E	F	G	H	J	K COM	L	M	N	O	P	Q	R	S	T	U	(# above U) *	S Nail	M Nail
1650	1659	1668	1677	1686	1695	1704	1713	1722	1731	1740	1749	1758	1767	1776	1785	1794	9 (Riser) + 1794 (U)	45	60
Leather 1 2370		Leather 2 2445		Leather 3 2520		Leather 4 2595		Leather 5 2670		Leather 6 2745		Leather 8 3345		COL 1722		S Nail 45		M Nail 60	

Fabric SKU: **8721-04**

Leather SKU: **L-8721-04**

Standard Pillows: N/A Finish Req: Y

Standard Cushions: High Resiliency 55 Standard Finish:

COM: 2.25 yards COL: 40 square feet

Brady Arm Chair

Width: 24 Depth: 25 Height: 39.5
 AH: 25.5 SH: 19 SD: 19 IW: 20
 Weight: 35 lbs Cube: 15.74

D	E	F	G	H	J	K COM	L	M	N	O	P	Q	R	S	T	U	(# above U) *	S Nail	M Nail
1050	1056	1062	1068	1074	1080	1086	1092	1098	1104	1110	1116	1122	1128	1134	1140	1146	6 (Riser) + 1146 (U)	45	60
Leather 1 1575		Leather 2 1635		Leather 3 1695		Leather 4 1755		Leather 5 1815		Leather 6 1875		Leather 8 2430		COL 1098		S Nail 45		M Nail 60	

Fabric SKU: **8726-01**

Leather SKU: **L-8726-01**

Standard Pillows: N/A Finish Req: Y

Standard Cushions: High Resiliency 40 Standard Finish:

COM: 3.25 yards COL: 53.1 square feet

Nora Occasional Chair

Width: 24.5 Depth: 25.5 Height: 40.5
 AH: 26 SH: 19.5 SD: 19.5 IW: 19.5
 Weight: 35 lbs Cube: 17.77

D	E	F	G	H	J	K COM	L	M	N	O	P	Q	R	S	T	U	(# above U) *	S Nail	M Nail
1350	1359	1368	1377	1386	1395	1404	1413	1422	1431	1440	1449	1458	1467	1476	1485	1494	9 (Riser) + 1494 (U)	N/A	N/A
Leather 1 1995		Leather 2 2085		Leather 3 2175		Leather 4 2265		Leather 5 2355		Leather 6 2445		Leather 8 3180		COL 1422		S Nail N/A		M Nail N/A	

Fabric SKU: **8727-04**

Leather SKU: **L-8727-04**

Standard Pillows: N/A Finish Req: Y

Standard Cushions: High Resiliency 40 Standard Finish:

COM: 2.25 yards COL: 38.7 square feet

Murphy Arm Chair

Width: 23.5 Depth: 22.5 Height: 34.5
 AH: 26 SH: 18.5 SD: 18.5 IW: 18
 Weight: 20 lbs Cube: 15.74

D	E	F	G	H	J	K COM	L	M	N	O	P	Q	R	S	T	U	(# above U) *	S Nail	M Nail
1602	1611	1620	1629	1638	1647	1656	1665	1674	1683	1692	1701	1710	1719	1728	1737	1746	9 (Riser) + 1746 (U)	45	N/A
Leather 1 2160		Leather 2 2220		Leather 3 2280		Leather 4 2340		Leather 5 2400		Leather 6 2460		Leather 8 3000		COL 1674		S Nail 45		M Nail N/A	

Fabric SKU: **8727-A4**

Leather SKU: **L-8727-A4**

Standard Pillows: N/A Finish Req: Y

Standard Cushions: High Resiliency 40 Standard Finish:

COM: 2.25 yards COL: 38.7 square feet

Murphy Arm Chair

Width: 23.5 Depth: 22.5 Height: 34.5
 AH: 26 SH: 18.5 SD: 18.5 IW: 18
 Weight: 22 lbs Cube: 15.74

D	E	F	G	H	J	K COM	L	M	N	O	P	Q	R	S	T	U	(# above U) *	S Nail	M Nail
1674	1683	1692	1701	1710	1719	1728	1737	1746	1755	1764	1773	1782	1791	1800	1809	1818	9 (Riser) + 1818 (U)	45	N/A
Leather 1 2250		Leather 2 2310		Leather 3 2370		Leather 4 2430		Leather 5 2490		Leather 6 2550		Leather 8 3090		COL 1746		S Nail 45		M Nail N/A	

Upholstery

**Pillows are not available on leather SKUs*

Fabric SKU: **8729-05**

Leather SKU: **L-8729-05**

Standard Pillows: N/A Finish Req: Y

Standard Cushions: High Resiliency 40 Standard Finish:

COM: 2 yards COL: 29 square feet

Douglas Side Chair

Width: 20.5 Depth: 21 Height: 31

AH: 0 SH: 18.5 SD: 19 IW: 20.5

Weight: 25 lbs Cube: 15.74

D	E	F	G	H	J	K COM	L	M	N	O	P	Q	R	S	T	U	(# above U) *	S Nail	M Nail
1170	1176	1182	1188	1194	1200	1206	1212	1218	1224	1230	1236	1242	1248	1254	1260	1266	6 (Riser) + 1266 (U)	45	N/A
Leather 1 1590		Leather 2 1635		Leather 3 1680		Leather 4 1725		Leather 5 1770		Leather 6 1815		Leather 8 2220		COL 1218		S Nail 45		M Nail N/A	

Fabric SKU: **8730-04**

Leather SKU: **L-8730-04**

Standard Pillows: N/A Finish Req: Y

Standard Cushions: High Resiliency 40 Standard Finish:

COM: 2 yards COL: 34.2 square feet

Edgemont Arm Chair

Width: 23.5 Depth: 25.5 Height: 36.5

AH: 25.5 SH: 18.5 SD: 18.5 IW: 20

Weight: 30 lbs Cube: 15.74

D	E	F	G	H	J	K COM	L	M	N	O	P	Q	R	S	T	U	(# above U) *	S Nail	M Nail
1290	1296	1302	1308	1314	1320	1326	1332	1338	1344	1350	1356	1362	1368	1374	1380	1386	6 (Riser) + 1386 (U)	N/A	N/A
Leather 1 1755		Leather 2 1815		Leather 3 1875		Leather 4 1935		Leather 5 1995		Leather 6 2055		Leather 8 2535		COL 1338		S Nail N/A		M Nail N/A	

Fabric SKU: **8732-01**

Leather SKU: **L-8732-01**

Standard Pillows: N/A Finish Req: Y

Standard Cushions: High Resiliency 40 Standard Finish:

COM: 2 yards COL: 34.2 square feet

Fayette Occasional Chair

Width: 26 Depth: 24.5 Height: 33

AH: 26 SH: 20 SD: 20.5 IW: 21

Weight: 35 lbs Cube: 15.74

D	E	F	G	H	J	K COM	L	M	N	O	P	Q	R	S	T	U	(# above U) *	S Nail	M Nail
1404	1410	1416	1422	1428	1434	1440	1446	1452	1458	1464	1470	1476	1482	1488	1494	1500	6 (Riser) + 1500 (U)	Std.	N/A
Leather 1 1845		Leather 2 1905		Leather 3 1965		Leather 4 2025		Leather 5 2085		Leather 6 2145		Leather 8 2625		COL 1452		S Nail Std.		M Nail N/A	

Fabric SKU: **8732-A4**

Leather SKU: **L-8732-A4**

Standard Pillows: N/A Finish Req: Y

Standard Cushions: High Resiliency 40 Standard Finish:

COM: 2 yards COL: 34.2 square feet

Fayette Occasional Chair

Width: 26 Depth: 24.5 Height: 33

AH: 26 SH: 19.5 SD: 19.5 IW: 21

Weight: 35 lbs Cube: 15.74

D	E	F	G	H	J	K COM	L	M	N	O	P	Q	R	S	T	U	(# above U) *	S Nail	M Nail
1476	1482	1488	1494	1500	1506	1512	1518	1524	1530	1536	1542	1548	1554	1560	1566	1572	6 (Riser) + 1572 (U)	Std.	N/A
Leather 1 1935		Leather 2 1995		Leather 3 2055		Leather 4 2115		Leather 5 2175		Leather 6 2235		Leather 8 2715		COL 1524		S Nail Std.		M Nail N/A	

Fabric SKU: **8735-04**

Leather SKU: **L-8735-04**

Standard Pillows: N/A Finish Req: Y

Standard Cushions: High Resiliency 40 Standard Finish:

COM: 4.25 yards COL: 68 square feet

Vanessa Arm Chair

Width: 26 Depth: 27.5 Height: 40

AH: 25.5 SH: 18.5 SD: 21 IW: 20

Weight: 33 lbs Cube: 21.65

D	E	F	G	H	J	K COM	L	M	N	O	P	Q	R	S	T	U	(# above U) *	S Nail	M Nail
1650	1662	1674	1686	1698	1710	1722	1734	1746	1758	1770	1782	1794	1806	1818	1830	1842	12 (Riser) + 1842 (U)	N/A	N/A
Leather 1 2565		Leather 2 2670		Leather 3 2775		Leather 4 2880		Leather 5 2985		Leather 6 3090		Leather 8 4035		COL 1746		S Nail N/A		M Nail N/A	

Fabric SKU: **8735-05**

Leather SKU: **L-8735-05**

Standard Pillows: N/A Finish Req: Y

Standard Cushions: High Resiliency 40 Standard Finish:

COM: 3.5 yards COL: 62 square feet

Vanessa Side Chair

Width: 25.5 Depth: 28 Height: 37.75

AH: 18 SH: 18 SD: 19.75 IW: 20.5

Weight: 32 lbs Cube: 21.65

D	E	F	G	H	J	K COM	L	M	N	O	P	Q	R	S	T	U	(# above U) *	S Nail	M Nail
1620	1632	1644	1656	1668	1680	1692	1704	1716	1728	1740	1752	1764	1776	1788	1800	1812	12 (Riser) + 1812 (U)	N/A	N/A
Leather 1 2400		Leather 2 2505		Leather 3 2610		Leather 4 2715		Leather 5 2820		Leather 6 2925		Leather 8 3780		COL 1716		S Nail N/A		M Nail N/A	

Upholstery

**Pillows are not available on leather SKUs*

Fabric SKU: **8735-A4**

Leather SKU: **L-8735-A4**

Standard Pillows: N/A **Finish Req:** Y

Standard Cushions: High Resiliency 40 **Standard Finish:**

COM: 4.25 yards **COL:** 68 square feet

Vanessa Arm Chair

Width: 26 **Depth:** 27.5 **Height:** 40

AH: 25.5 **SH:** 18.5 **SD:** 21 **IW:** 20

Weight: 33 lbs **Cube:** 21.65

D	E	F	G	H	J	K COM	L	M	N	O	P	Q	R	S	T	U	(# above U) *	S Nail	M Nail
1722	1734	1746	1758	1770	1782	1794	1806	1818	1830	1842	1854	1866	1878	1890	1902	1914	12 (Riser) + 1914 (U)	N/A	N/A
Leather 1 2640		Leather 2 2745		Leather 3 2850		Leather 4 2955		Leather 5 3060		Leather 6 3165		Leather 8 4110		COL 1818		S Nail N/A		M Nail N/A	

Fabric SKU: **8740-04**

Leather SKU: **L-8740-04**

Standard Pillows: N/A **Finish Req:** Y

Standard Cushions: High Resiliency 40 **Standard Finish:**

COM: 2.75 yards **COL:** 51 square feet

Standard 2" Channel Quilt on Outside Back

Anthony Arm Chair

Width: 24 **Depth:** 26 **Height:** 33

AH: 24.5 **SH:** 19.5 **SD:** 20 **IW:** 18

Weight: 24 lbs **Cube:** 15.74

D	E	F	G	H	J	K COM	L	M	N	O	P	Q	R	S	T	U	(# above U) *	S Nail	M Nail
1575	1584	1593	1602	1611	1620	1629	1638	1647	1656	1665	1674	1683	1692	1701	1710	1719	9 (Riser) + 1719 (U)	60	75
Leather 1 2250		Leather 2 2325		Leather 3 2400		Leather 4 2475		Leather 5 2550		Leather 6 2625		Leather 8 3330		COL 1647		S Nail 60		M Nail 75	

Fabric SKU: **8740-05**

Leather SKU: **L-8740-05**

Standard Pillows: N/A **Finish Req:** Y

Standard Cushions: High Resiliency 40 **Standard Finish:**

COM: 2.5 yards **COL:** 45 square feet

Standard 2" Channel Quilt on Outside Back

Anthony Side Chair

Width: 22.5 **Depth:** 25 **Height:** 33.5

AH: 20 **SH:** 19.5 **SD:** 19.5 **IW:** 18

Weight: 23 lbs **Cube:** 15.74

D	E	F	G	H	J	K COM	L	M	N	O	P	Q	R	S	T	U	(# above U) *	S Nail	M Nail
1560	1569	1578	1587	1596	1605	1614	1623	1632	1641	1650	1659	1668	1677	1686	1695	1704	9 (Riser) + 1704 (U)	60	75
Leather 1 2100		Leather 2 2175		Leather 3 2250		Leather 4 2325		Leather 5 2400		Leather 6 2475		Leather 8 3105		COL 1632		S Nail 60		M Nail 75	

Fabric SKU: **8740-07**

Leather SKU: **L-8740-07**

Standard Pillows: N/A **Finish Req:** Y

Standard Cushions: High Resiliency 40 **Standard Finish:**

COM: 2.5 yards **COL:** 45 square feet

Standard 2" Channel Quilt on Outside Back

Anthony Bar Stool

Width: 21.5 **Depth:** 22 **Height:** 43.5

AH: 30 **SH:** 30 **SD:** 17.5 **IW:** 17.5

Weight: 40 lbs **Cube:** 17.77

D	E	F	G	H	J	K COM	L	M	N	O	P	Q	R	S	T	U	(# above U) *	S Nail	M Nail
1800	1809	1818	1827	1836	1845	1854	1863	1872	1881	1890	1899	1908	1917	1926	1935	1944	9 (Riser) + 1944 (U)	60	75
Leather 1 2400		Leather 2 2475		Leather 3 2550		Leather 4 2625		Leather 5 2700		Leather 6 2775		Leather 8 3405		COL 1872		S Nail 60		M Nail 75	

Fabric SKU: **8740-A2**

Leather SKU: **L-8740-A2**

Standard Pillows: N/A **Finish Req:** Y

Standard Cushions: High Resiliency 40 **Standard Finish:**

COM: 2.75 yards **COL:** 51 square feet

Standard 2" Channel Quilt on Outside Back

Anthony Arm Chair

Width: 24 **Depth:** 26 **Height:** 33

AH: 24.5 **SH:** 19.5 **SD:** 20 **IW:** 18

Weight: 24 lbs **Cube:** 21.65

D	E	F	G	H	J	K COM	L	M	N	O	P	Q	R	S	T	U	(# above U) *	S Nail	M Nail
1611	1620	1629	1638	1647	1656	1665	1674	1683	1692	1701	1710	1719	1728	1737	1746	1755	9 (Riser) + 1755 (U)	60	75
Leather 1 2280		Leather 2 2355		Leather 3 2430		Leather 4 2505		Leather 5 2580		Leather 6 2655		Leather 8 3360		COL 1683		S Nail 60		M Nail 75	

Fabric SKU: **8740-A4**

Leather SKU: **L-8740-A4**

Standard Pillows: N/A **Finish Req:** Y

Standard Cushions: High Resiliency 40 **Standard Finish:**

COM: 2.75 yards **COL:** 51 square feet

Standard 2" Channel Quilt on Outside Back

Anthony Arm Chair

Width: 24 **Depth:** 26 **Height:** 33

AH: 24.5 **SH:** 19.5 **SD:** 20 **IW:** 18

Weight: 26 lbs **Cube:** 15.74

D	E	F	G	H	J	K COM	L	M	N	O	P	Q	R	S	T	U	(# above U) *	S Nail	M Nail
1647	1656	1665	1674	1683	1692	1701	1710	1719	1728	1737	1746	1755	1764	1773	1782	1791	9 (Riser) + 1791 (U)	60	75
Leather 1 2325		Leather 2 2400		Leather 3 2475		Leather 4 2550		Leather 5 2625		Leather 6 2700		Leather 8 3405		COL 1719		S Nail 60		M Nail 75	

Upholstery

**Pillows are not available on leather SKUs*

Fabric SKU: **8740-C7**

Leather SKU: **L-8740-C7**

Standard Pillows: N/A Finish Req: Y

Standard Cushions: High Resiliency 40 Standard Finish:

COM: 2.5 yards COL: 43.2 square feet

Standard 2" Channel Quilt on Outside Back

Anthony Counter Stool

Width: 21.5 Depth: 22 Height: 39.5

AH: 30 SH: 26 SD: 17.5 IW: 17.5

Weight: 35 lbs Cube: 15.74

D	E	F	G	H	J	K COM	L	M	N	O	P	Q	R	S	T	U	(# above U) *	S Nail	M Nail
1800	1809	1818	1827	1836	1845	1854	1863	1872	1881	1890	1899	1908	1917	1926	1935	1944	9 (Riser) + 1944 (U)	60	75
Leather 1 2445		Leather 2 2520		Leather 3 2595		Leather 4 2670		Leather 5 2745		Leather 6 2820		Leather 8 3420		COL 1872		S Nail 60		M Nail 75	

Fabric SKU: **8741-04**

Leather SKU: **L-8741-04**

Standard Pillows: N/A Finish Req: Y

Standard Cushions: High Resiliency 40 Standard Finish:

COM: 2.75 yards COL: 51 square feet

Anthony Arm Chair

Width: 24 Depth: 26 Height: 33

AH: 24.5 SH: 19.5 SD: 20 IW: 18

Weight: 24 lbs Cube: 15.74

D	E	F	G	H	J	K COM	L	M	N	O	P	Q	R	S	T	U	(# above U) *	S Nail	M Nail
1497	1506	1515	1524	1533	1542	1551	1560	1569	1578	1587	1596	1605	1614	1623	1632	1641	9 (Riser) + 1641 (U)	60	75
Leather 1 2100		Leather 2 2175		Leather 3 2250		Leather 4 2325		Leather 5 2400		Leather 6 2475		Leather 8 3180		COL 1569		S Nail 60		M Nail 75	

Fabric SKU: **8741-05**

Leather SKU: **L-8741-05**

Standard Pillows: N/A Finish Req: Y

Standard Cushions: High Resiliency 40 Standard Finish:

COM: 2.5 yards COL: 45 square feet

Anthony Side Chair

Width: 22.5 Depth: 25 Height: 33.5

AH: 20 SH: 19.5 SD: 19.5 IW: 18

Weight: 23 lbs Cube: 15.74

D	E	F	G	H	J	K COM	L	M	N	O	P	Q	R	S	T	U	(# above U) *	S Nail	M Nail
1467	1476	1485	1494	1503	1512	1521	1530	1539	1548	1557	1566	1575	1584	1593	1602	1611	9 (Riser) + 1611 (U)	60	75
Leather 1 2070		Leather 2 2145		Leather 3 2220		Leather 4 2295		Leather 5 2370		Leather 6 2445		Leather 8 3075		COL 1539		S Nail 60		M Nail 75	

Fabric SKU: **8741-07**

Leather SKU: **L-8741-07**

Standard Pillows: N/A Finish Req: Y

Standard Cushions: High Resiliency 40 Standard Finish:

COM: 2.5 yards COL: 40 square feet

Anthony Bar Stool

Width: 21.5 Depth: 22 Height: 43.5

AH: 30 SH: 30 SD: 17.5 IW: 17.5

Weight: 25 lbs Cube: 19.6

D	E	F	G	H	J	K COM	L	M	N	O	P	Q	R	S	T	U	(# above U) *	S Nail	M Nail
1785	1794	1803	1812	1821	1830	1839	1848	1857	1866	1875	1884	1893	1902	1911	1920	1929	9 (Riser) + 1929 (U)	60	75
Leather 1 2355		Leather 2 2415		Leather 3 2475		Leather 4 2535		Leather 5 2595		Leather 6 2655		Leather 8 3210		COL 1857		S Nail 60		M Nail 75	

Fabric SKU: **8741-A2**

Leather SKU: **L-8741-A2**

Standard Pillows: N/A Finish Req: Y

Standard Cushions: High Resiliency 40 Standard Finish:

COM: 2.75 yards COL: 51 square feet

Anthony Arm Chair

Width: 24 Depth: 26 Height: 33

AH: 24.5 SH: 19.5 SD: 20 IW: 18

Weight: 25 lbs Cube: 21.65

D	E	F	G	H	J	K COM	L	M	N	O	P	Q	R	S	T	U	(# above U) *	S Nail	M Nail
1533	1542	1551	1560	1569	1578	1587	1596	1605	1614	1623	1632	1641	1650	1659	1668	1677	9 (Riser) + 1677 (U)	60	75
Leather 1 2130		Leather 2 2205		Leather 3 2280		Leather 4 2355		Leather 5 2430		Leather 6 2505		Leather 8 3210		COL 1605		S Nail 60		M Nail 75	

Fabric SKU: **8741-A4**

Leather SKU: **L-8741-A4**

Standard Pillows: N/A Finish Req: Y

Standard Cushions: High Resiliency 40 Standard Finish:

COM: 2.75 yards COL: 51 square feet

Anthony Arm Chair

Width: 24 Depth: 26 Height: 33

AH: 24.5 SH: 19.5 SD: 20 IW: 18

Weight: 26 lbs Cube: 21.65

D	E	F	G	H	J	K COM	L	M	N	O	P	Q	R	S	T	U	(# above U) *	S Nail	M Nail
1569	1578	1587	1596	1605	1614	1623	1632	1641	1650	1659	1668	1677	1686	1695	1704	1713	9 (Riser) + 1713 (U)	60	75
Leather 1 2175		Leather 2 2250		Leather 3 2325		Leather 4 2400		Leather 5 2475		Leather 6 2550		Leather 8 3255		COL 1641		S Nail 60		M Nail 75	

Upholstery

**Pillows are not available on leather SKUs*

Fabric SKU: **8741-C7**

Leather SKU: **L-8741-C7**

Standard Pillows: N/A Finish Req: Y

Standard Cushions: High Resiliency 40 Standard Finish:

COM: 2.5 yards COL: 43.2 square feet

Anthony Counter Stool

Width: 21.5 Depth: 22 Height: 39.5

AH: 30 SH: 26.5 SD: 17.5 IW: 17.5

Weight: 35 lbs Cube: 15.74

D	E	F	G	H	J	K COM	L	M	N	O	P	Q	R	S	T	U	(# above U) *	S Nail	M Nail
1785	1794	1803	1812	1821	1830	1839	1848	1857	1866	1875	1884	1893	1902	1911	1920	1929	9 (Riser) + 1929 (U)	60	75
Leather 1 2355		Leather 2 2430		Leather 3 2505		Leather 4 2580		Leather 5 2655		Leather 6 2730		Leather 8 3330		COL 1857		S Nail 60		M Nail 75	

Fabric SKU: **8742-04**

Leather SKU: **L-8742-04**

Standard Pillows: N/A Finish Req: Y

Standard Cushions: High Resiliency 40 Standard Finish:

COM: 2 yards COL: 40 square feet

Proctor Arm Chair

Width: 24 Depth: 23 Height: 35

AH: 26.5 SH: 19 SD: 18.5 IW: 20

Weight: 30 lbs Cube: 15.74

D	E	F	G	H	J	K COM	L	M	N	O	P	Q	R	S	T	U	(# above U) *	S Nail	M Nail
1260	1266	1272	1278	1284	1290	1296	1302	1308	1314	1320	1326	1332	1338	1344	1350	1356	6 (Riser) + 1356 (U)	45	N/A
Leather 1 1740		Leather 2 1800		Leather 3 1860		Leather 4 1920		Leather 5 1980		Leather 6 2040		Leather 8 2595		COL 1308		S Nail 45		M Nail N/A	

Fabric SKU: **8744-04**

Leather SKU: **L-8744-04**

Standard Pillows: N/A Finish Req: Y

Standard Cushions: High Resiliency 40 Standard Finish:

COM: 2.25 yards COL: 45 square feet

Langston Arm Chair

Width: 24.5 Depth: 25 Height: 38.5

AH: 25 SH: 19 SD: 19 IW: 20.5

Weight: 30 lbs Cube: 15.74

D	E	F	G	H	J	K COM	L	M	N	O	P	Q	R	S	T	U	(# above U) *	S Nail	M Nail
1242	1251	1260	1269	1278	1287	1296	1305	1314	1323	1332	1341	1350	1359	1368	1377	1386	9 (Riser) + 1386 (U)	45	N/A
Leather 1 1710		Leather 2 1785		Leather 3 1860		Leather 4 1935		Leather 5 2010		Leather 6 2085		Leather 8 2715		COL 1314		S Nail 45		M Nail N/A	

Fabric SKU: **8744-A4**

Leather SKU: **L-8744-A4**

Standard Pillows: N/A Finish Req: Y

Standard Cushions: High Resiliency 40 Standard Finish:

COM: 2.25 yards COL: 38.7 square feet

Langston Arm Chair

Width: 24.5 Depth: 25 Height: 38.5

AH: 25 SH: 19 SD: 19 IW: 20.5

Weight: 30 lbs Cube: 21.09

D	E	F	G	H	J	K COM	L	M	N	O	P	Q	R	S	T	U	(# above U) *	S Nail	M Nail
1314	1323	1332	1341	1350	1359	1368	1377	1386	1395	1404	1413	1422	1431	1440	1449	1458	9 (Riser) + 1458 (U)	45	N/A
Leather 1 1800		Leather 2 1860		Leather 3 1920		Leather 4 1980		Leather 5 2040		Leather 6 2100		Leather 8 2640		COL 1386		S Nail 45		M Nail N/A	

Fabric SKU: **8745-04**

Leather SKU: **L-8745-04**

Standard Pillows: N/A Finish Req: Y

Standard Cushions: High Resiliency 40 Standard Finish:

COM: 2 yards COL: 40 square feet

Potter Arm Chair

Width: 24 Depth: 23 Height: 35

AH: 26.5 SH: 19 SD: 18.5 IW: 20

Weight: 30 lbs Cube: 15.74

D	E	F	G	H	J	K COM	L	M	N	O	P	Q	R	S	T	U	(# above U) *	S Nail	M Nail
1050	1056	1062	1068	1074	1080	1086	1092	1098	1104	1110	1116	1122	1128	1134	1140	1146	6 (Riser) + 1146 (U)	45	N/A
Leather 1 1485		Leather 2 1545		Leather 3 1605		Leather 4 1665		Leather 5 1725		Leather 6 1785		Leather 8 2340		COL 1098		S Nail 45		M Nail N/A	

Fabric SKU: **8745-06**

Leather SKU: **L-8745-06**

Standard Pillows: N/A Finish Req: Y

Standard Cushions: High Resiliency 40 Standard Finish:

COM: 2 yards COL: 40 square feet

Potter Bar Stool

Width: 22 Depth: 22.5 Height: 44

AH: 35.5 SH: 30 SD: 18 IW: 19

Weight: 25 lbs Cube: 19.6

D	E	F	G	H	J	K COM	L	M	N	O	P	Q	R	S	T	U	(# above U) *	S Nail	M Nail
1395	1401	1407	1413	1419	1425	1431	1437	1443	1449	1455	1461	1467	1473	1479	1485	1491	6 (Riser) + 1491 (U)	45	N/A
Leather 1 1845		Leather 2 1905		Leather 3 1965		Leather 4 2025		Leather 5 2085		Leather 6 2145		Leather 8 2700		COL 1443		S Nail 45		M Nail N/A	

Upholstery

**Pillows are not available on leather SKUs*

Fabric SKU: **8745-C6**

Leather SKU: **L-8745-C6**

Standard Pillows: N/A Finish Req: Y

Standard Cushions: High Resiliency 40 Standard Finish:

COM: 2 yards COL: 34.2 square feet

Potter Counter Stool

Width: 22 Depth: 22.5 Height: 40

AH: 31.5 SH: 26 SD: 18 IW: 19

Weight: 25 lbs Cube: 17.77

D	E	F	G	H	J	K COM	L	M	N	O	P	Q	R	S	T	U	(# above U) *	S Nail	M Nail
1395	1401	1407	1413	1419	1425	1431	1437	1443	1449	1455	1461	1467	1473	1479	1485	1491	6 (Riser) + 1491 (U)	45	N/A
Leather 1 1845		Leather 2 1905		Leather 3 1965		Leather 4 2025		Leather 5 2085		Leather 6 2145		Leather 8 2625		COL 1443		S Nail 45		M Nail N/A	

Fabric SKU: **8747-04**

Leather SKU: **L-8747-04**

Standard Pillows: N/A Finish Req: Y

Standard Cushions: High Resiliency 40 Standard Finish:

COM: 2 yards COL: 35 square feet

Garland Arm Chair

Width: 23.5 Depth: 24.5 Height: 39

AH: 25.5 SH: 19 SD: 18 IW: 19

Weight: 35 lbs Cube: 15.74

D	E	F	G	H	J	K COM	L	M	N	O	P	Q	R	S	T	U	(# above U) *	S Nail	M Nail
1125	1131	1137	1143	1149	1155	1161	1167	1173	1179	1185	1191	1197	1203	1209	1215	1221	6 (Riser) + 1221 (U)	45	N/A
Leather 1 1545		Leather 2 1605		Leather 3 1665		Leather 4 1725		Leather 5 1785		Leather 6 1845		Leather 8 2325		COL 1173		S Nail 45		M Nail N/A	

Fabric SKU: **8747-40**

Leather SKU: **L-8747-40**

Standard Pillows: N/A Finish Req: Y

Standard Cushions: High Resiliency 40 Standard Finish:

COM: 4 yards COL: 63.75 square feet

Garland Settee

Width: 49.5 Depth: 24 Height: 34

AH: 25.5 SH: 18.5 SD: 18 IW: 44.5

Weight: 50 lbs Cube: 29.96

D	E	F	G	H	J	K COM	L	M	N	O	P	Q	R	S	T	U	(# above U) *	S Nail	M Nail
1950	1962	1974	1986	1998	2010	2022	2034	2046	2058	2070	2082	2094	2106	2118	2130	2142	12 (Riser) + 2142 (U)	60	45
Leather 1 2700		Leather 2 2805		Leather 3 2910		Leather 4 3015		Leather 5 3120		Leather 6 3225		Leather 8 4110		COL 2046		S Nail 60		M Nail 45	

Fabric SKU: **8747-A4**

Leather SKU: **L-8747-A4**

Standard Pillows: N/A Finish Req: Y

Standard Cushions: High Resiliency 40 Standard Finish:

COM: 2 yards COL: 35 square feet

Garland Arm Chair

Width: 23.5 Depth: 24.5 Height: 39

AH: 25.5 SH: 19 SD: 18 IW: 19

Weight: 35 lbs Cube: 15.74

D	E	F	G	H	J	K COM	L	M	N	O	P	Q	R	S	T	U	(# above U) *	S Nail	M Nail
1197	1203	1209	1215	1221	1227	1233	1239	1245	1251	1257	1263	1269	1275	1281	1287	1293	6 (Riser) + 1293 (U)	45	N/A
Leather 1 1620		Leather 2 1680		Leather 3 1740		Leather 4 1800		Leather 5 1860		Leather 6 1920		Leather 8 2400		COL 1245		S Nail 45		M Nail N/A	

Fabric SKU: **8749-04**

Leather SKU: **L-8749-04**

Standard Pillows: N/A Finish Req: Y

Standard Cushions: High Resiliency 40 Standard Finish:

COM: 2.25 yards COL: 45 square feet

Palmer Arm Chair

Width: 24 Depth: 24 Height: 38.5

AH: 25 SH: 20 SD: 18 IW: 19.5

Weight: 23 lbs Cube: 21.65

D	E	F	G	H	J	K COM	L	M	N	O	P	Q	R	S	T	U	(# above U) *	S Nail	M Nail
1425	1434	1443	1452	1461	1470	1479	1488	1497	1506	1515	1524	1533	1542	1551	1560	1569	9 (Riser) + 1569 (U)	45	N/A
Leather 1 1980		Leather 2 2055		Leather 3 2130		Leather 4 2205		Leather 5 2280		Leather 6 2355		Leather 8 2985		COL 1497		S Nail 45		M Nail N/A	

Fabric SKU: **8749-A2**

Leather SKU: **L-8749-A2**

Standard Pillows: N/A Finish Req: Y

Standard Cushions: High Resiliency 40 Standard Finish:

COM: 2.25 yards COL: 45 square feet

Palmer Arm Chair

Width: 24 Depth: 24 Height: 38.5

AH: 25 SH: 20 SD: 18 IW: 19.5

Weight: 24 lbs Cube: 15.74

D	E	F	G	H	J	K COM	L	M	N	O	P	Q	R	S	T	U	(# above U) *	S Nail	M Nail
1461	1470	1479	1488	1497	1506	1515	1524	1533	1542	1551	1560	1569	1578	1587	1596	1605	9 (Riser) + 1605 (U)	45	N/A
Leather 1 2010		Leather 2 2085		Leather 3 2160		Leather 4 2235		Leather 5 2310		Leather 6 2385		Leather 8 3015		COL 1533		S Nail 45		M Nail N/A	

Upholstery

**Pillows are not available on leather SKUs*

Fabric SKU: **8749-A4**

Leather SKU: **L-8749-A4**

Standard Pillows: N/A Finish Req: Y

Standard Cushions: High Resiliency 40 Standard Finish:

COM: 2.25 yards COL: 45 square feet

Palmer Arm Chair

Width: 24 Depth: 24 Height: 38.5

AH: 25 SH: 20 SD: 18 IW: 19.5

Weight: 25 lbs Cube: 21.65

D	E	F	G	H	J	K COM	L	M	N	O	P	Q	R	S	T	U	(# above U) *	S Nail	M Nail
1497	1506	1515	1524	1533	1542	1551	1560	1569	1578	1587	1596	1605	1614	1623	1632	1641	9 (Riser) + 1641 (U)	45	N/A
Leather 1 2055		Leather 2 2130		Leather 3 2205		Leather 4 2280		Leather 5 2355		Leather 6 2430		Leather 8 3060		COL 1569		S Nail 45		M Nail N/A	

Fabric SKU: **8750-04**

Leather SKU: **L-8750-04**

Standard Pillows: N/A Finish Req: Y

Standard Cushions: High Resiliency 40 Standard Finish:

COM: 2.25 yards COL: 45 square feet

Jade Arm Chair

Width: 23 Depth: 25 Height: 35

AH: 25 SH: 18.5 SD: 18.5 IW: 19

Weight: 22 lbs Cube: 15.74

D	E	F	G	H	J	K COM	L	M	N	O	P	Q	R	S	T	U	(# above U) *	S Nail	M Nail
1197	1203	1209	1215	1221	1227	1233	1239	1245	1251	1257	1263	1269	1275	1281	1287	1293	6 (Riser) + 1293 (U)	N/A	N/A
Leather 1 1650		Leather 2 1725		Leather 3 1800		Leather 4 1875		Leather 5 1950		Leather 6 2025		Leather 8 2655		COL 1245		S Nail N/A		M Nail N/A	

Fabric SKU: **8750-05**

Leather SKU: **L-8750-05**

Standard Pillows: N/A Finish Req: Y

Standard Cushions: High Resiliency 40 Standard Finish:

COM: 2.25 yards COL: 40 square feet

Jade Side Chair

Width: 21.5 Depth: 27 Height: 37.5

AH: 0 SH: 19 SD: 17.5 IW: 21.5

Weight: 19 lbs Cube: 15.74

D	E	F	G	H	J	K COM	L	M	N	O	P	Q	R	S	T	U	(# above U) *	S Nail	M Nail
1167	1173	1179	1185	1191	1197	1203	1209	1215	1221	1227	1233	1239	1245	1251	1257	1263	6 (Riser) + 1263 (U)	N/A	N/A
Leather 1 1620		Leather 2 1680		Leather 3 1740		Leather 4 1800		Leather 5 1860		Leather 6 1920		Leather 8 2475		COL 1215		S Nail N/A		M Nail N/A	

Fabric SKU: **8750-A4**

Leather SKU: **L-8750-A4**

Standard Pillows: N/A Finish Req: Y

Standard Cushions: High Resiliency 40 Standard Finish:

COM: 2.25 yards COL: 45 square feet

Jade Arm Chair

Width: 23 Depth: 25 Height: 35

AH: 25 SH: 18.5 SD: 18.5 IW: 19

Weight: 22 lbs Cube: 15.74

D	E	F	G	H	J	K COM	L	M	N	O	P	Q	R	S	T	U	(# above U) *	S Nail	M Nail
1269	1275	1281	1287	1293	1299	1305	1311	1317	1323	1329	1335	1341	1347	1353	1359	1365	6 (Riser) + 1365 (U)	N/A	N/A
Leather 1 1725		Leather 2 1800		Leather 3 1875		Leather 4 1950		Leather 5 2025		Leather 6 2100		Leather 8 2730		COL 1317		S Nail N/A		M Nail N/A	

Fabric SKU: **8751-04**

Leather SKU: **L-8751-04**

Standard Pillows: N/A Finish Req: Y

Standard Cushions: High Resiliency 40 Standard Finish:

COM: 2.25 yards COL: 34 square feet

Jude Arm Chair

Width: 23 Depth: 25 Height: 35

AH: 25 SH: 18.5 SD: 18.5 IW: 19

Weight: 22 lbs Cube: 15.74

D	E	F	G	H	J	K COM	L	M	N	O	P	Q	R	S	T	U	(# above U) *	S Nail	M Nail
1422	1428	1434	1440	1446	1452	1458	1464	1470	1476	1482	1488	1494	1500	1506	1512	1518	6 (Riser) + 1518 (U)	N/A	N/A
Leather 1 1920		Leather 2 1980		Leather 3 2040		Leather 4 2100		Leather 5 2160		Leather 6 2220		Leather 8 2685		COL 1470		S Nail N/A		M Nail N/A	

Fabric SKU: **8751-05**

Leather SKU: **L-8751-05**

Standard Pillows: N/A Finish Req: Y

Standard Cushions: High Resiliency 40 Standard Finish:

COM: 2.25 yards COL: 38.7 square feet

Jude Side Chair

Width: 21.5 Depth: 27 Height: 37.5

AH: 0 SH: 19 SD: 17.5 IW: 21.5

Weight: 19 lbs Cube: 15.74

D	E	F	G	H	J	K COM	L	M	N	O	P	Q	R	S	T	U	(# above U) *	S Nail	M Nail
1392	1398	1404	1410	1416	1422	1428	1434	1440	1446	1452	1458	1464	1470	1476	1482	1488	6 (Riser) + 1488 (U)	N/A	N/A
Leather 1 1875		Leather 2 1935		Leather 3 1995		Leather 4 2055		Leather 5 2115		Leather 6 2175		Leather 8 2715		COL 1440		S Nail N/A		M Nail N/A	

Upholstery

**Pillows are not available on leather SKUs*

Fabric SKU: **8755-04**

Leather SKU: **L-8755-04**

Standard Pillows: N/A Finish Req: Y

Standard Cushions: High Resiliency 55 Standard Finish:

COM: 2 yards COL: 34.2 square feet

Opel Arm Chair

Width: 25.5 Depth: 22.5 Height: 39.5

AH: 26 SH: 19.5 SD: 20 IW: 23

Weight: 40 lbs Cube: 15.74

D	E	F	G	H	J	K COM	L	M	N	O	P	Q	R	S	T	U	(# above U) *	S Nail	M Nail
1272	1278	1284	1290	1296	1302	1308	1314	1320	1326	1332	1338	1344	1350	1356	1362	1368	6 (Riser) + 1368 (U)	N/A	N/A
Leather 1 1755		Leather 2 1815		Leather 3 1875		Leather 4 1935		Leather 5 1995		Leather 6 2055		Leather 8 2535		COL 1320		S Nail N/A		M Nail N/A	

Fabric SKU: **8755-A4**

Leather SKU: **L-8755-A4**

Standard Pillows: N/A Finish Req: Y

Standard Cushions: High Resiliency 55 Standard Finish:

COM: 2 yards COL: 34.2 square feet

Opel Arm Chair

Width: 25.5 Depth: 22.5 Height: 39.5

AH: 26 SH: 19.5 SD: 20 IW: 23

Weight: 40 lbs Cube: 17.77

D	E	F	G	H	J	K COM	L	M	N	O	P	Q	R	S	T	U	(# above U) *	S Nail	M Nail
1344	1350	1356	1362	1368	1374	1380	1386	1392	1398	1404	1410	1416	1422	1428	1434	1440	6 (Riser) + 1440 (U)	N/A	N/A
Leather 1 1830		Leather 2 1890		Leather 3 1950		Leather 4 2010		Leather 5 2070		Leather 6 2130		Leather 8 2610		COL 1392		S Nail N/A		M Nail N/A	

Fabric SKU: **8762-01**

Leather SKU: **L-8762-01**

Standard Pillows: N/A Finish Req: Y

Standard Cushions: High Resiliency 40 Standard Finish:

COM: 2.5 yards COL: 51 square feet

Laguna Occasional Chair

Width: 24 Depth: 23 Height: 36.5

AH: 25.5 SH: 19.5 SD: 18 IW: 20.5

Weight: 35 lbs Cube: 15.74

D	E	F	G	H	J	K COM	L	M	N	O	P	Q	R	S	T	U	(# above U) *	S Nail	M Nail
1404	1413	1422	1431	1440	1449	1458	1467	1476	1485	1494	1503	1512	1521	1530	1539	1548	9 (Riser) + 1548 (U)	N/A	N/A
Leather 1 1980		Leather 2 2055		Leather 3 2130		Leather 4 2205		Leather 5 2280		Leather 6 2355		Leather 8 3060		COL 1476		S Nail N/A		M Nail N/A	

Fabric SKU: **8764-01**

Leather SKU: **L-8764-01**

Standard Pillows: N/A Finish Req: Y

Standard Cushions: High Resiliency 40 Standard Finish:

COM: 3.75 yards COL: 59.5 square feet

Perkins Occasional Chair

Width: 26.5 Depth: 28.5 Height: 39.5

AH: 25.5 SH: 19.5 SD: 18.5 IW: 20

Weight: 35 lbs Cube: 21.65

D	E	F	G	H	J	K COM	L	M	N	O	P	Q	R	S	T	U	(# above U) *	S Nail	M Nail
1632	1644	1656	1668	1680	1692	1704	1716	1728	1740	1752	1764	1776	1788	1800	1812	1824	12 (Riser) + 1824 (U)	45	60
Leather 1 2475		Leather 2 2565		Leather 3 2655		Leather 4 2745		Leather 5 2835		Leather 6 2925		Leather 8 3750		COL 1728		S Nail 45		M Nail 60	

Fabric SKU: **8769-04**

Leather SKU: **L-8769-04**

Standard Pillows: N/A Finish Req: Y

Standard Cushions: High Resiliency 55 Standard Finish:

COM: 2 yards COL: 34.2 square feet

Jennifer Arm Chair

Width: 24.5 Depth: 27 Height: 40

AH: 26.5 SH: 19 SD: 18.5 IW: 21

Weight: 30 lbs Cube: 17.77

D	E	F	G	H	J	K COM	L	M	N	O	P	Q	R	S	T	U	(# above U) *	S Nail	M Nail
1290	1296	1302	1308	1314	1320	1326	1332	1338	1344	1350	1356	1362	1368	1374	1380	1386	6 (Riser) + 1386 (U)	N/A	N/A
Leather 1 1710		Leather 2 1770		Leather 3 1830		Leather 4 1890		Leather 5 1950		Leather 6 2010		Leather 8 2490		COL 1338		S Nail N/A		M Nail N/A	

Fabric SKU: **8769-A4**

Leather SKU: **L-8769-A4**

Standard Pillows: N/A Finish Req: Y

Standard Cushions: High Resiliency 55 Standard Finish:

COM: 2 yards COL: 34.2 square feet

Jennifer Arm Chair

Width: 24.5 Depth: 27 Height: 40

AH: 26.5 SH: 20 SD: 19 IW: 21

Weight: 35 lbs Cube: 21.65

D	E	F	G	H	J	K COM	L	M	N	O	P	Q	R	S	T	U	(# above U) *	S Nail	M Nail
1362	1368	1374	1380	1386	1392	1398	1404	1410	1416	1422	1428	1434	1440	1446	1452	1458	6 (Riser) + 1458 (U)	N/A	N/A
Leather 1 1800		Leather 2 1860		Leather 3 1920		Leather 4 1980		Leather 5 2040		Leather 6 2100		Leather 8 2580		COL 1410		S Nail N/A		M Nail N/A	

Upholstery

**Pillows are not available on leather SKUs*

Fabric SKU: **8770-04**

Leather SKU: **L-8770-04**

Standard Pillows: N/A **Finish Req:** Y

Standard Cushions: High Resiliency 40 **Standard Finish:**

COM: 2 yards **COL:** 34.2 square feet

Also available with two front casters (8770-A2). Not available with four casters due to frame construction.

Laughlin Arm Chair

Width: 22 **Depth:** 23.5 **Height:** 36.5

AH: 26.5 **SH:** 18.5 **SD:** 18 **IW:** 20

Weight: 25 lbs **Cube:** 15.74

D	E	F	G	H	J	K COM	L	M	N	O	P	Q	R	S	T	U	(# above U) *	S Nail	M Nail
1125	1131	1137	1143	1149	1155	1161	1167	1173	1179	1185	1191	1197	1203	1209	1215	1221	6 (Riser) + 1221 (U)	N/A	N/A
Leather 1 1665		Leather 2 1725		Leather 3 1785		Leather 4 1845		Leather 5 1905		Leather 6 1965		Leather 8 2445		COL 1173		S Nail N/A		M Nail N/A	

Fabric SKU: **8771-04**

Leather SKU: **L-8771-04**

Standard Pillows: N/A **Finish Req:** Y

Standard Cushions: High Resiliency 40 **Standard Finish:**

COM: 2 yards **COL:** 38 square feet

0

Mapleton Arm Chair

Width: 24 **Depth:** 23 **Height:** 37.5

AH: 26.5 **SH:** 18.5 **SD:** 18 **IW:** 20

Weight: 25 lbs **Cube:** 15.74

D	E	F	G	H	J	K COM	L	M	N	O	P	Q	R	S	T	U	(# above U) *	S Nail	M Nail
1050	1056	1062	1068	1074	1080	1086	1092	1098	1104	1110	1116	1122	1128	1134	1140	1146	6 (Riser) + 1146 (U)	N/A	N/A
Leather 1 1530		Leather 2 1590		Leather 3 1650		Leather 4 1710		Leather 5 1770		Leather 6 1830		Leather 8 2355		COL 1098		S Nail N/A		M Nail N/A	

Fabric SKU: **8771-A4**

Leather SKU: **L-8771-A4**

Standard Pillows: N/A **Finish Req:** Y

Standard Cushions: High Resiliency 40 **Standard Finish:**

COM: 2 yards **COL:** 38 square feet

Mapleton Arm Chair

Width: 24 **Depth:** 23 **Height:** 37.5

AH: 26.5 **SH:** 18.5 **SD:** 18 **IW:** 20

Weight: 30 lbs **Cube:** 15.74

D	E	F	G	H	J	K COM	L	M	N	O	P	Q	R	S	T	U	(# above U) *	S Nail	M Nail
1122	1128	1134	1140	1146	1152	1158	1164	1170	1176	1182	1188	1194	1200	1206	1212	1218	6 (Riser) + 1218 (U)	N/A	N/A
Leather 1 1605		Leather 2 1665		Leather 3 1725		Leather 4 1785		Leather 5 1845		Leather 6 1905		Leather 8 2430		COL 1170		S Nail N/A		M Nail N/A	

Fabric SKU: **8772-04**

Leather SKU: **L-8772-04**

Standard Pillows: N/A **Finish Req:** Y

Standard Cushions: High Resiliency 40 **Standard Finish:**

COM: 2 yards **COL:** 34.2 square feet

Naples Arm Chair

Width: 22.5 **Depth:** 24 **Height:** 33

AH: 25.5 **SH:** 19 **SD:** 19 **IW:** 19.5

Weight: 30 lbs **Cube:** 15.74

D	E	F	G	H	J	K COM	L	M	N	O	P	Q	R	S	T	U	(# above U) *	S Nail	M Nail
1242	1248	1254	1260	1266	1272	1278	1284	1290	1296	1302	1308	1314	1320	1326	1332	1338	6 (Riser) + 1338 (U)	45	N/A
Leather 1 1695		Leather 2 1755		Leather 3 1815		Leather 4 1875		Leather 5 1935		Leather 6 1995		Leather 8 2475		COL 1290		S Nail 45		M Nail N/A	

Fabric SKU: **8772-A4**

Leather SKU: **L-8772-A4**

Standard Pillows: N/A **Finish Req:** Y

Standard Cushions: High Resiliency 40 **Standard Finish:**

COM: 2 yards **COL:** 34.2 square feet

Naples Arm Chair

Width: 22.5 **Depth:** 24 **Height:** 33

AH: 25.5 **SH:** 19 **SD:** 19 **IW:** 19.5

Weight: 30 lbs **Cube:** 15.74

D	E	F	G	H	J	K COM	L	M	N	O	P	Q	R	S	T	U	(# above U) *	S Nail	M Nail
1314	1320	1326	1332	1338	1344	1350	1356	1362	1368	1374	1380	1386	1392	1398	1404	1410	6 (Riser) + 1410 (U)	45	N/A
Leather 1 1770		Leather 2 1830		Leather 3 1890		Leather 4 1950		Leather 5 2010		Leather 6 2070		Leather 8 2550		COL 1362		S Nail 45		M Nail N/A	

Fabric SKU: **8773-04**

Leather SKU: **L-8773-04**

Standard Pillows: N/A **Finish Req:** Y

Standard Cushions: High Resiliency 40 **Standard Finish:**

COM: 5.5 yards **COL:** 90.95 square feet

Carla Arm Chair

Width: 24.5 **Depth:** 29 **Height:** 44

AH: 24 **SH:** 21 **SD:** 18.5 **IW:** 19

Weight: 40 lbs **Cube:** 24.14

D	E	F	G	H	J	K COM	L	M	N	O	P	Q	R	S	T	U	(# above U) *	S Nail	M Nail
1650	1665	1680	1695	1710	1725	1740	1755	1770	1785	1800	1815	1830	1845	1860	1875	1890	15 (Riser) + 1890 (U)	60	75
Leather 1 2775		Leather 2 2910		Leather 3 3045		Leather 4 3180		Leather 5 3315		Leather 6 3450		Leather 8 4710		COL 1770		S Nail 60		M Nail 75	

Upholstery

**Pillows are not available on leather SKUs*

Fabric SKU: **8773-05**

Leather SKU: **L-8773-05**

Standard Pillows: N/A Finish Req: Y

Standard Cushions: High Resiliency 40 Standard Finish:

COM: 4.75 yards COL: 77.35 square feet

Carla Side Chair

Width: 21 Depth: 29.5 Height: 44.5

AH: 0 SH: 20 SD: 18 IW: 20

Weight: 30 lbs Cube: 24.14

D	E	F	G	H	J	K COM	L	M	N	O	P	Q	R	S	T	U	(# above U) *	S Nail	M Nail
1560	1575	1590	1605	1620	1635	1650	1665	1680	1695	1710	1725	1740	1755	1770	1785	1800	15 (Riser) + 1800 (U)	60	75
Leather 1 2475		Leather 2 2595		Leather 3 2715		Leather 4 2835		Leather 5 2955		Leather 6 3075		Leather 8 4140		COL 1680		S Nail 60		M Nail 75	

Fabric SKU: **8774-05**

Leather SKU: **N/A**

Standard Pillows: N/A Finish Req: N

Standard Cushions: High Resiliency 40 Standard Finish: Traditional

COM: 5.5 yards COL: N/A

Charlotte Side Chair

Width: 21 Depth: 29.5 Height: 44.5

AH: 0 SH: 20 SD: 18 IW: 20

Weight: 31 lbs Cube: 21.65

D	E	F	G	H	J	K COM	L	M	N	O	P	Q	R	S	T	U	(# above U) *	S Nail	M Nail
1725	1743	1761	1779	1797	1815	1833	1851	1869	1887	1905	1923	1941	1959	1977	1995	2013	18 (Riser) + 2013 (U)	45	60
Leather 1 N/A		Leather 2 N/A		Leather 3 N/A		Leather 4 N/A		Leather 5 N/A		Leather 6 N/A		Leather 8 N/A		COL N/A		S Nail N/A		M Nail N/A	

Fabric SKU: **8778-04**

Leather SKU: **L-8778-04**

Standard Pillows: N/A Finish Req: Y

Standard Cushions: High Resiliency 40 Standard Finish:

COM: 2 yards COL: 34.2 square feet

Pryor Arm Chair

Width: 24.5 Depth: 24.5 Height: 38.5

AH: 26.5 SH: 19 SD: 18 IW: 19.5

Weight: 30 lbs Cube: 15.74

D	E	F	G	H	J	K COM	L	M	N	O	P	Q	R	S	T	U	(# above U) *	S Nail	M Nail
1290	1296	1302	1308	1314	1320	1326	1332	1338	1344	1350	1356	1362	1368	1374	1380	1386	6 (Riser) + 1386 (U)	N/A	N/A
Leather 1 1740		Leather 2 1800		Leather 3 1860		Leather 4 1920		Leather 5 1980		Leather 6 2040		Leather 8 2520		COL 1338		S Nail N/A		M Nail N/A	

Fabric SKU: **8778-A4**

Leather SKU: **L-8778-A4**

Standard Pillows: N/A Finish Req: Y

Standard Cushions: High Resiliency 40 Standard Finish:

COM: 2 yards COL: 34.2 square feet

Pryor Arm Chair

Width: 24.5 Depth: 24.5 Height: 38.5

AH: 26.5 SH: 19 SD: 18 IW: 19.5

Weight: 30 lbs Cube: 15.74

D	E	F	G	H	J	K COM	L	M	N	O	P	Q	R	S	T	U	(# above U) *	S Nail	M Nail
1362	1368	1374	1380	1386	1392	1398	1404	1410	1416	1422	1428	1434	1440	1446	1452	1458	6 (Riser) + 1458 (U)	N/A	N/A
Leather 1 1815		Leather 2 1875		Leather 3 1935		Leather 4 1995		Leather 5 2055		Leather 6 2115		Leather 8 2595		COL 1410		S Nail N/A		M Nail N/A	

Fabric SKU: **8779-04**

Leather SKU: **L-8779-04**

Standard Pillows: N/A Finish Req: Y

Standard Cushions: High Resiliency 40 Standard Finish:

COM: 2 yards COL: 40 square feet

Hughes Arm Chair

Width: 23 Depth: 24 Height: 39.5

AH: 27 SH: 20 SD: 17.5 IW: 20

Weight: 22 lbs Cube: 15.74

D	E	F	G	H	J	K COM	L	M	N	O	P	Q	R	S	T	U	(# above U) *	S Nail	M Nail
1290	1296	1302	1308	1314	1320	1326	1332	1338	1344	1350	1356	1362	1368	1374	1380	1386	6 (Riser) + 1386 (U)	45	N/A
Leather 1 1740		Leather 2 1800		Leather 3 1860		Leather 4 1920		Leather 5 1980		Leather 6 2040		Leather 8 2595		COL 1338		S Nail 45		M Nail N/A	

Fabric SKU: **8779-A4**

Leather SKU: **L-8779-A4**

Standard Pillows: N/A Finish Req: Y

Standard Cushions: High Resiliency 40 Standard Finish:

COM: 2 yards COL: 40 square feet

Hughes Arm Chair

Width: 23 Depth: 24 Height: 39.5

AH: 27 SH: 20 SD: 17.5 IW: 20

Weight: 23 lbs Cube: 17.77

D	E	F	G	H	J	K COM	L	M	N	O	P	Q	R	S	T	U	(# above U) *	S Nail	M Nail
1362	1368	1374	1380	1386	1392	1398	1404	1410	1416	1422	1428	1434	1440	1446	1452	1458	6 (Riser) + 1458 (U)	45	N/A
Leather 1 1815		Leather 2 1875		Leather 3 1935		Leather 4 1995		Leather 5 2055		Leather 6 2115		Leather 8 2670		COL 1410		S Nail 45		M Nail N/A	

Upholstery

**Pillows are not available on leather SKUs*

Fabric SKU: **8780-04**

Leather SKU: **L-8780-04**

Standard Pillows: N/A Finish Req: Y

Standard Cushions: High Resiliency 40 Standard Finish:

COM: 2 yards COL: 34.2 square feet

Oakland Arm Chair

Width: 23 Depth: 24 Height: 37.5

AH: 25.5 SH: 19 SD: 18 IW: 20.5

Weight: 30 lbs Cube: 15.74

D	E	F	G	H	J	K COM	L	M	N	O	P	Q	R	S	T	U	(# above U) *	S Nail	M Nail
1365	1371	1377	1383	1389	1395	1401	1407	1413	1419	1425	1431	1437	1443	1449	1455	1461	6 (Riser) + 1461 (U)	45	N/A
Leather 1 1830		Leather 2 1890		Leather 3 1950		Leather 4 2010		Leather 5 2070		Leather 6 2130		Leather 8 2610		COL 1413		S Nail 45		M Nail N/A	

Fabric SKU: **8780-A4**

Leather SKU: **L-8780-A4**

Standard Pillows: N/A Finish Req: Y

Standard Cushions: High Resiliency 40 Standard Finish:

COM: 2 yards COL: 34.2 square feet

Oakland Arm Chair

Width: 23 Depth: 24 Height: 37.5

AH: 25.5 SH: 19 SD: 18 IW: 20.5

Weight: 31 lbs Cube: 17.77

D	E	F	G	H	J	K COM	L	M	N	O	P	Q	R	S	T	U	(# above U) *	S Nail	M Nail
1437	1443	1449	1455	1461	1467	1473	1479	1485	1491	1497	1503	1509	1515	1521	1527	1533	6 (Riser) + 1533 (U)	45	N/A
Leather 1 1920		Leather 2 1980		Leather 3 2040		Leather 4 2100		Leather 5 2160		Leather 6 2220		Leather 8 2700		COL 1485		S Nail 45		M Nail N/A	

Fabric SKU: **8783-11**

Leather SKU: **L-8783-11**

Standard Pillows: N/A Finish Req: Y

Standard Cushions: High Resiliency 40 Standard Finish:

COM: 2 yards COL: 34.2 square feet

Available in FairShield Plus Finishes Only. Warranted for stacking three high.

Oakridge Arm Stack Chair

Width: 23 Depth: 24 Height: 37.5

AH: 25.5 SH: 19 SD: 18.5 IW: 20

Weight: 30 lbs Cube: 15.74

D	E	F	G	H	J	K COM	L	M	N	O	P	Q	R	S	T	U	(# above U) *	S Nail	M Nail
1230	1236	1242	1248	1254	1260	1266	1272	1278	1284	1290	1296	1302	1308	1314	1320	1326	6 (Riser) + 1326 (U)	N/A	N/A
Leather 1 1650		Leather 2 1710		Leather 3 1770		Leather 4 1830		Leather 5 1890		Leather 6 1950		Leather 8 2430		COL 1278		S Nail N/A		M Nail N/A	

Fabric SKU: **8784-04**

Leather SKU: **L-8784-04**

Standard Pillows: N/A Finish Req: Y

Standard Cushions: High Resiliency 40 Standard Finish:

COM: 4.25 yards COL: 72 square feet

Hayley Arm Chair

Width: 27 Depth: 24.5 Height: 30.5

AH: 25 SH: 19.5 SD: 20 IW: 19

Weight: 35 lbs Cube: 21.65

D	E	F	G	H	J	K COM	L	M	N	O	P	Q	R	S	T	U	(# above U) *	S Nail	M Nail
2010	2022	2034	2046	2058	2070	2082	2094	2106	2118	2130	2142	2154	2166	2178	2190	2202	12 (Riser) + 2202 (U)	75	90
Leather 1 3030		Leather 2 3150		Leather 3 3270		Leather 4 3390		Leather 5 3510		Leather 6 3630		Leather 8 4620		COL 2106		S Nail 75		M Nail 90	

Fabric SKU: **8784-1N**

Leather SKU: **L-8784-1N**

Standard Pillows: N/A Finish Req: N

Standard Cushions: High Resiliency 40 Standard Finish: Nickel

COM: 4.25 yards COL: 72 square feet

Features Swivel Nickel Base with Casters

Hayley Task Chair

Width: 27 Depth: 25.5 Height: 31.25

AH: 27.75 SH: 20.75 SD: 21.5 IW: 19

Weight: 41 lbs Cube: 21.65

D	E	F	G	H	J	K COM	L	M	N	O	P	Q	R	S	T	U	(# above U) *	S Nail	M Nail
2295	2307	2319	2331	2343	2355	2367	2379	2391	2403	2415	2427	2439	2451	2463	2475	2487	12 (Riser) + 2487 (U)	N/A	N/A
Leather 1 3285		Leather 2 3405		Leather 3 3525		Leather 4 3645		Leather 5 3765		Leather 6 3885		Leather 8 4875		COL 2391		S Nail N/A		M Nail N/A	

Fabric SKU: **8784-2N**

Leather SKU: **L-8784-2N**

Standard Pillows: N/A Finish Req: N

Standard Cushions: High Resiliency 40 Standard Finish: Nickel

COM: 4.25 yards COL: 72 square feet

Features Stationary Nickel Plated Base with a gas cylinder.

Hayley Swivel Chair

Width: 27 Depth: 25.5 Height: 28.75

AH: 26.25 SH: 19.25 SD: 21.5 IW: 19

Weight: 40 lbs Cube: 21.65

D	E	F	G	H	J	K COM	L	M	N	O	P	Q	R	S	T	U	(# above U) *	S Nail	M Nail
2295	2307	2319	2331	2343	2355	2367	2379	2391	2403	2415	2427	2439	2451	2463	2475	2487	12 (Riser) + 2487 (U)	N/A	N/A
Leather 1 3285		Leather 2 3405		Leather 3 3525		Leather 4 3645		Leather 5 3765		Leather 6 3885		Leather 8 4875		COL 2391		S Nail N/A		M Nail N/A	

Upholstery

**Pillows are not available on leather SKUs*

Fabric SKU: **8784-A2**

Leather SKU: **L-8784-A2**

Standard Pillows: N/A Finish Req: Y

Standard Cushions: High Resiliency 40 Standard Finish:

COM: 4.25 yards COL: 72 square feet

Hayley Arm Chair

Width: 27 Depth: 24.5 Height: 30.5

AH: 25 SH: 19.5 SD: 20 IW: 19

Weight: 35 lbs Cube: 21.65

D	E	F	G	H	J	K COM	L	M	N	O	P	Q	R	S	T	U	(# above U) *	S Nail	M Nail
2046	2058	2070	2082	2094	2106	2118	2130	2142	2154	2166	2178	2190	2202	2214	2226	2238	12 (Riser) + 2238 (U)	75	90
Leather 1 3060		Leather 2 3180		Leather 3 3300		Leather 4 3420		Leather 5 3540		Leather 6 3660		Leather 8 4650		COL 2142		S Nail 75		M Nail 90	

Fabric SKU: **8784-A4**

Leather SKU: **L-8784-A4**

Standard Pillows: N/A Finish Req: Y

Standard Cushions: High Resiliency 40 Standard Finish:

COM: 4.25 yards COL: 72 square feet

Hayley Arm Chair

Width: 27 Depth: 24.5 Height: 30.5

AH: 25 SH: 19.5 SD: 20 IW: 19

Weight: 35 lbs Cube: 21.65

D	E	F	G	H	J	K COM	L	M	N	O	P	Q	R	S	T	U	(# above U) *	S Nail	M Nail
2082	2094	2106	2118	2130	2142	2154	2166	2178	2190	2202	2214	2226	2238	2250	2262	2274	12 (Riser) + 2274 (U)	75	90
Leather 1 3105		Leather 2 3225		Leather 3 3345		Leather 4 3465		Leather 5 3585		Leather 6 3705		Leather 8 4695		COL 2178		S Nail 75		M Nail 90	

Fabric SKU: **8788-04**

Leather SKU: **L-8788-04**

Standard Pillows: N/A Finish Req: Y

Standard Cushions: High Resiliency 40 Standard Finish:

COM: 2 yards COL: 34.2 square feet

Oakwood Arm Chair

Width: 23 Depth: 24 Height: 37.5

AH: 25.5 SH: 19 SD: 19 IW: 20

Weight: 30 lbs Cube: 15.74

D	E	F	G	H	J	K COM	L	M	N	O	P	Q	R	S	T	U	(# above U) *	S Nail	M Nail
1320	1326	1332	1338	1344	1350	1356	1362	1368	1374	1380	1386	1392	1398	1404	1410	1416	6 (Riser) + 1416 (U)	45	N/A
Leather 1 1800		Leather 2 1860		Leather 3 1920		Leather 4 1980		Leather 5 2040		Leather 6 2100		Leather 8 2580		COL 1368		S Nail 45		M Nail N/A	

Fabric SKU: **8788-A4**

Leather SKU: **L-8788-A4**

Standard Pillows: N/A Finish Req: Y

Standard Cushions: High Resiliency 40 Standard Finish:

COM: 2 yards COL: 34.2 square feet

Oakwood Arm Chair

Width: 23 Depth: 24 Height: 40

AH: 25.5 SH: 19 SD: 19 IW: 20

Weight: 30 lbs Cube: 15.74

D	E	F	G	H	J	K COM	L	M	N	O	P	Q	R	S	T	U	(# above U) *	S Nail	M Nail
1392	1398	1404	1410	1416	1422	1428	1434	1440	1446	1452	1458	1464	1470	1476	1482	1488	6 (Riser) + 1488 (U)	45	N/A
Leather 1 1875		Leather 2 1935		Leather 3 1995		Leather 4 2055		Leather 5 2115		Leather 6 2175		Leather 8 2655		COL 1440		S Nail 45		M Nail N/A	

Fabric SKU: **8794-04**

Leather SKU: **L-8794-04**

Standard Pillows: N/A Finish Req: Y

Standard Cushions: High Resiliency 55 Standard Finish:

COM: 3.25 yards COL: 51 square feet

Bryant Arm Chair

Width: 24 Depth: 23 Height: 32

AH: 27 SH: 19.5 SD: 19 IW: 17.5

Weight: 25 lbs Cube: 15.74

D	E	F	G	H	J	K COM	L	M	N	O	P	Q	R	S	T	U	(# above U) *	S Nail	M Nail
1680	1689	1698	1707	1716	1725	1734	1743	1752	1761	1770	1779	1788	1797	1806	1815	1824	9 (Riser) + 1824 (U)	75	N/A
Leather 1 2475		Leather 2 2550		Leather 3 2625		Leather 4 2700		Leather 5 2775		Leather 6 2850		Leather 8 3555		COL 1752		S Nail 75		M Nail N/A	

Fabric SKU: **8794-06**

Leather SKU: **L-8794-06**

Standard Pillows: N/A Finish Req: Y

Standard Cushions: High Resiliency 55 Standard Finish:

COM: 3.25 yards COL: 53.1 square feet

Bryant Bar Stool

Width: 24 Depth: 23 Height: 42

AH: 37 SH: 30 SD: 19 IW: 17.5

Weight: 35 lbs Cube: 19.6

D	E	F	G	H	J	K COM	L	M	N	O	P	Q	R	S	T	U	(# above U) *	S Nail	M Nail
1785	1794	1803	1812	1821	1830	1839	1848	1857	1866	1875	1884	1893	1902	1911	1920	1929	9 (Riser) + 1929 (U)	75	N/A
Leather 1 2625		Leather 2 2715		Leather 3 2805		Leather 4 2895		Leather 5 2985		Leather 6 3075		Leather 8 3810		COL 1857		S Nail 75		M Nail N/A	

Upholstery

**Pillows are not available on leather SKUs*

Fabric SKU: **8794-40**

Leather SKU: **L-8794-40**

Standard Pillows: N/A Finish Req: Y

Standard Cushions: HR-55 DAC Standard Finish:

COM: 4 yards COL: 63.75 square feet

Bryant Settee

Width: 56.25 Depth: 23 Height: 32

AH: 27 SH: 19.5 SD: 19 IW: 50

Weight: 52 lbs Cube: 55.51

D	E	F	G	H	J	K COM	L	M	N	O	P	Q	R	S	T	U	(# above U) *	S Nail	M Nail
2640	2652	2664	2676	2688	2700	2712	2724	2736	2748	2760	2772	2784	2796	2808	2820	2832	12 (Riser) + 2832 (U)	120	N/A
Leather 1 3465		Leather 2 3570		Leather 3 3675		Leather 4 3780		Leather 5 3885		Leather 6 3990		Leather 8 4875		COL 2736		S Nail 120		M Nail N/A	

Fabric SKU: **8794-1N**

Leather SKU: **L-8794-1N**

Standard Pillows: N/A Finish Req: N

Standard Cushions: High Resiliency 55 Standard Finish: Nickel

COM: 3.25 yards COL: 53.1 square feet

Features Swivel Nickel Base with Casters

Bryant Task Chair

Width: 24 Depth: 24 Height: 31.5

AH: 27.5 SH: 20.5 SD: 19 IW: 17.5

Weight: 40 lbs Cube: 21.65

D	E	F	G	H	J	K COM	L	M	N	O	P	Q	R	S	T	U	(# above U) *	S Nail	M Nail
1890	1899	1908	1917	1926	1935	1944	1953	1962	1971	1980	1989	1998	2007	2016	2025	2034	9 (Riser) + 2034 (U)	75	N/A
Leather 1 2730		Leather 2 2820		Leather 3 2910		Leather 4 3000		Leather 5 3090		Leather 6 3180		Leather 8 3915		COL 1962		S Nail 75		M Nail N/A	

Fabric SKU: **8794-2N**

Leather SKU: **L-8794-2N**

Standard Pillows: N/A Finish Req: N

Standard Cushions: High Resiliency 55 Standard Finish: Nickel

COM: 3.25 yards COL: 53.1 square feet

Features Stationary Nickel Plated Base with a gas cylinder.

Bryant Swivel Chair

Width: 24 Depth: 24 Height: 30

AH: 26 SH: 19 SD: 19 IW: 17.5

Weight: 40 lbs Cube: 15.74

D	E	F	G	H	J	K COM	L	M	N	O	P	Q	R	S	T	U	(# above U) *	S Nail	M Nail
1890	1899	1908	1917	1926	1935	1944	1953	1962	1971	1980	1989	1998	2007	2016	2025	2034	9 (Riser) + 2034 (U)	75	N/A
Leather 1 2730		Leather 2 2820		Leather 3 2910		Leather 4 3000		Leather 5 3090		Leather 6 3180		Leather 8 3915		COL 1962		S Nail 75		M Nail N/A	

Fabric SKU: **8794-A2**

Leather SKU: **L-8794-A2**

Standard Pillows: N/A Finish Req: Y

Standard Cushions: High Resiliency 55 Standard Finish:

COM: 3.25 yards COL: 51 square feet

Bryant Arm Chair

Width: 24 Depth: 23 Height: 32

AH: 27 SH: 19.5 SD: 19 IW: 17.5

Weight: 27 lbs Cube: 15.74

D	E	F	G	H	J	K COM	L	M	N	O	P	Q	R	S	T	U	(# above U) *	S Nail	M Nail
1716	1725	1734	1743	1752	1761	1770	1779	1788	1797	1806	1815	1824	1833	1842	1851	1860	9 (Riser) + 1860 (U)	75	N/A
Leather 1 2505		Leather 2 2580		Leather 3 2655		Leather 4 2730		Leather 5 2805		Leather 6 2880		Leather 8 3585		COL 1788		S Nail 75		M Nail N/A	

Fabric SKU: **8794-BB**

Leather SKU: **L-8794-BB**

Standard Pillows: N/A Finish Req: Y

Standard Cushions: High Resiliency 55 Standard Finish:

COM: 4.25 yards COL: 72 square feet

Bryant Bar Bench

Width: 56.25 Depth: 23 Height: 42

AH: 37 SH: 30 SD: 19 IW: 50

Weight: 50 lbs Cube: 44.07

D	E	F	G	H	J	K COM	L	M	N	O	P	Q	R	S	T	U	(# above U) *	S Nail	M Nail
2667	2679	2691	2703	2715	2727	2739	2751	2763	2775	2787	2799	2811	2823	2835	2847	2859	12 (Riser) + 2859 (U)	120	N/A
Leather 1 3600		Leather 2 3720		Leather 3 3840		Leather 4 3960		Leather 5 4080		Leather 6 4200		Leather 8 5190		COL 2763		S Nail 120		M Nail N/A	

Fabric SKU: **8794-C6**

Leather SKU: **L-8794-C6**

Standard Pillows: N/A Finish Req: Y

Standard Cushions: High Resiliency 55 Standard Finish:

COM: 3.25 yards COL: 53.1 square feet

Bryant Counter Stool

Width: 24 Depth: 23 Height: 38

AH: 33 SH: 26 SD: 19 IW: 17.5

Weight: 30 lbs Cube: 15.74

D	E	F	G	H	J	K COM	L	M	N	O	P	Q	R	S	T	U	(# above U) *	S Nail	M Nail
1785	1794	1803	1812	1821	1830	1839	1848	1857	1866	1875	1884	1893	1902	1911	1920	1929	9 (Riser) + 1929 (U)	75	N/A
Leather 1 2625		Leather 2 2715		Leather 3 2805		Leather 4 2895		Leather 5 2985		Leather 6 3075		Leather 8 3810		COL 1857		S Nail 75		M Nail N/A	

Upholstery

**Pillows are not available on leather SKUs*

Fabric SKU: **8794-CB**

Leather SKU: **L-8794-CB**

Standard Pillows: N/A Finish Req: Y

Standard Cushions: High Resiliency 55 Standard Finish:

COM: 4.25 yards COL: 72 square feet

Bryant Counter Bench

Width: 56.25 Depth: 23 Height: 38

AH: 33 SH: 26 SD: 19 IW: 50

Weight: 40 lbs Cube: 29.96

D	E	F	G	H	J	K COM	L	M	N	O	P	Q	R	S	T	U	(# above U) *	S Nail	M Nail
2667	2679	2691	2703	2715	2727	2739	2751	2763	2775	2787	2799	2811	2823	2835	2847	2859	12 (Riser) + 2859 (U)	120	N/A
Leather 1 3600		Leather 2 3720		Leather 3 3840		Leather 4 3960		Leather 5 4080		Leather 6 4200		Leather 8 5190		COL 2763		S Nail 120		M Nail N/A	

Fabric SKU: **8794-M6**

Leather SKU: **L-8794-M6**

Standard Pillows: N/A Finish Req: N

Standard Cushions: High Resiliency 55 Standard Finish: Nickel

COM: 3.25 yards COL: 53.1 square feet

Bryant Multi-Height Bar Stool

Width: 24 Depth: 23 Height: 38.5

AH: 0 SH: 0 SD: 19 IW: 17.5

Weight: 43 lbs Cube: 15.74

D	E	F	G	H	J	K COM	L	M	N	O	P	Q	R	S	T	U	(# above U) *	S Nail	M Nail
2550	2559	2568	2577	2586	2595	2604	2613	2622	2631	2640	2649	2658	2667	2676	2685	2694	9 (Riser) + 2694 (U)	75	N/A
Leather 1 3285		Leather 2 3375		Leather 3 3465		Leather 4 3555		Leather 5 3645		Leather 6 3735		Leather 8 4470		COL 2622		S Nail 75		M Nail N/A	

Fabric SKU: **8796-04**

Leather SKU: **L-8796-04**

Standard Pillows: N/A Finish Req: Y

Standard Cushions: High Resiliency 40 Standard Finish:

COM: 2 yards COL: 38 square feet

Gates Arm Chair

Width: 23 Depth: 24 Height: 34.5

AH: 25 SH: 20 SD: 19.5 IW: 19.5

Weight: 25 lbs Cube: 15.74

D	E	F	G	H	J	K COM	L	M	N	O	P	Q	R	S	T	U	(# above U) *	S Nail	M Nail
1197	1203	1209	1215	1221	1227	1233	1239	1245	1251	1257	1263	1269	1275	1281	1287	1293	6 (Riser) + 1293 (U)	N/A	N/A
Leather 1 1545		Leather 2 1605		Leather 3 1665		Leather 4 1725		Leather 5 1785		Leather 6 1845		Leather 8 2370		COL 1245		S Nail N/A		M Nail N/A	

Fabric SKU: **8796-A2**

Leather SKU: **L-8796-A2**

Standard Pillows: N/A Finish Req: Y

Standard Cushions: High Resiliency 40 Standard Finish:

COM: 2 yards COL: 38 square feet

Gates Arm Chair

Width: 23 Depth: 24 Height: 34.5

AH: 25 SH: 20 SD: 19.5 IW: 19.5

Weight: 26 lbs Cube: 21.65

D	E	F	G	H	J	K COM	L	M	N	O	P	Q	R	S	T	U	(# above U) *	S Nail	M Nail
1233	1239	1245	1251	1257	1263	1269	1275	1281	1287	1293	1299	1305	1311	1317	1323	1329	6 (Riser) + 1329 (U)	N/A	N/A
Leather 1 1575		Leather 2 1635		Leather 3 1695		Leather 4 1755		Leather 5 1815		Leather 6 1875		Leather 8 2400		COL 1281		S Nail N/A		M Nail N/A	

Fabric SKU: **8801-04**

Leather SKU: **L-8801-04**

Standard Pillows: N/A Finish Req: Y

Standard Cushions: High Resiliency 40 Standard Finish:

COM: 2 yards COL: 40 square feet

Features a hidden handle

Stella Arm Chair

Width: 24.25 Depth: 28 Height: 38.5

AH: 25 SH: 19.75 SD: 18.5 IW: 20.25

Weight: 23 lbs Cube: 15.74

D	E	F	G	H	J	K COM	L	M	N	O	P	Q	R	S	T	U	(# above U) *	S Nail	M Nail
1197	1206	1215	1224	1233	1242	1251	1260	1269	1278	1287	1296	1305	1314	1323	1332	1341	9 (Riser) + 1341 (U)	45	N/A
Leather 1 1650		Leather 2 1710		Leather 3 1770		Leather 4 1830		Leather 5 1890		Leather 6 1950		Leather 8 2505		COL 1269		S Nail 45		M Nail N/A	

Fabric SKU: **8801-A2**

Leather SKU: **L-8801-A2**

Standard Pillows: N/A Finish Req: Y

Standard Cushions: High Resiliency 40 Standard Finish:

COM: 2 yards COL: 40 square feet

Standard with 2 front casters and features a hidden handle

Stella Arm Chair

Width: 24.25 Depth: 28 Height: 38.5

AH: 25 SH: 19.75 SD: 18.5 IW: 20.25

Weight: 23 lbs Cube: 15.12

D	E	F	G	H	J	K COM	L	M	N	O	P	Q	R	S	T	U	(# above U) *	S Nail	M Nail
1233	1242	1251	1260	1269	1278	1287	1296	1305	1314	1323	1332	1341	1350	1359	1368	1377	9 (Riser) + 1377 (U)	45	N/A
Leather 1 1680		Leather 2 1740		Leather 3 1800		Leather 4 1860		Leather 5 1920		Leather 6 1980		Leather 8 2535		COL 1305		S Nail 45		M Nail N/A	

Upholstery

**Pillows are not available on leather SKUs*

Fabric SKU: **8801-A4**

Leather SKU: **L-8801-A4**

Standard Pillows: N/A Finish Req: Y

Standard Cushions: High Resiliency 40 Standard Finish:

COM: 2 yards COL: 40 square feet

Standard with casters on all legs and features a hidden handle

Stella Arm Chair

Width: 24.25 Depth: 28 Height: 38.5

AH: 25 SH: 19.75 SD: 18.5 IW: 20.25

Weight: 23 lbs Cube: 15.12

D	E	F	G	H	J	K COM	L	M	N	O	P	Q	R	S	T	U	(# above U) *	S Nail	M Nail
1269	1278	1287	1296	1305	1314	1323	1332	1341	1350	1359	1368	1377	1386	1395	1404	1413	9 (Riser) + 1413 (U)	45	N/A
Leather 1 1725		Leather 2 1785		Leather 3 1845		Leather 4 1905		Leather 5 1965		Leather 6 2025		Leather 8 2580		COL 1341		S Nail 45		M Nail N/A	

Fabric SKU: **8810-04**

Leather SKU: **L-8810-04**

Standard Pillows: N/A Finish Req: Y

Standard Cushions: High Resiliency 40 Standard Finish:

COM: 2 yards COL: 40 square feet

Walsh Arm Chair

Width: 23.5 Depth: 26 Height: 40

AH: 25 SH: 19 SD: 19 IW: 20

Weight: 23 lbs Cube: 15.74

D	E	F	G	H	J	K COM	L	M	N	O	P	Q	R	S	T	U	(# above U) *	S Nail	M Nail
1302	1308	1314	1320	1326	1332	1338	1344	1350	1356	1362	1368	1374	1380	1386	1392	1398	6 (Riser) + 1398 (U)	N/A	N/A
Leather 1 1710		Leather 2 1770		Leather 3 1830		Leather 4 1890		Leather 5 1950		Leather 6 2010		Leather 8 2565		COL 1350		S Nail N/A		M Nail N/A	

Fabric SKU: **8812-05**

Leather SKU: **L-8812-05**

Standard Pillows: N/A Finish Req: Y

Standard Cushions: High Resiliency 40 Standard Finish:

COM: 2 yards COL: 34.2 square feet

Barkley Side Chair

Width: 23 Depth: 23 Height: 38.5

AH: 0 SH: 20 SD: 18.25 IW: 23

Weight: 19 lbs Cube: 15.74

D	E	F	G	H	J	K COM	L	M	N	O	P	Q	R	S	T	U	(# above U) *	S Nail	M Nail
1305	1311	1317	1323	1329	1335	1341	1347	1353	1359	1365	1371	1377	1383	1389	1395	1401	6 (Riser) + 1401 (U)	45	60
Leather 1 1755		Leather 2 1815		Leather 3 1875		Leather 4 1935		Leather 5 1995		Leather 6 2055		Leather 8 2535		COL 1353		S Nail 45		M Nail 60	

Fabric SKU: **8814-05**

Leather SKU: **L-8814-05**

Standard Pillows: N/A Finish Req: Y

Standard Cushions: High Resiliency 40 Standard Finish:

COM: 3.5 yards COL: 51 square feet

Jacqueline Side Chair

Width: 19.5 Depth: 25.5 Height: 37

AH: 0 SH: 19 SD: 19 IW: 19.5

Weight: 17 lbs Cube: 15.74

D	E	F	G	H	J	K COM	L	M	N	O	P	Q	R	S	T	U	(# above U) *	S Nail	M Nail
1140	1149	1158	1167	1176	1185	1194	1203	1212	1221	1230	1239	1248	1257	1266	1275	1284	9 (Riser) + 1284 (U)	45	N/A
Leather 1 1890		Leather 2 1965		Leather 3 2040		Leather 4 2115		Leather 5 2190		Leather 6 2265		Leather 8 2970		COL 1212		S Nail 45		M Nail N/A	

Fabric SKU: **8815-05**

Leather SKU: **L-8815-05**

Standard Pillows: N/A Finish Req: Y

Standard Cushions: High Resiliency 40 Standard Finish:

COM: 2.5 yards COL: 57 square feet

Bryce Side Chair

Width: 21.5 Depth: 25.5 Height: 40

AH: 0 SH: 19 SD: 19 IW: 21.5

Weight: 18 lbs Cube: 17.77

D	E	F	G	H	J	K COM	L	M	N	O	P	Q	R	S	T	U	(# above U) *	S Nail	M Nail
1140	1149	1158	1167	1176	1185	1194	1203	1212	1221	1230	1239	1248	1257	1266	1275	1284	9 (Riser) + 1284 (U)	45	N/A
Leather 1 1890		Leather 2 1980		Leather 3 2070		Leather 4 2160		Leather 5 2250		Leather 6 2340		Leather 8 3135		COL 1212		S Nail 45		M Nail N/A	

Fabric SKU: **8816-05**

Leather SKU: **N/A**

Standard Pillows: N/A Finish Req: Y

Standard Cushions: High Resiliency 40 Standard Finish:

COM: 3.5 yards COL: N/A

Audrey Side Chair

Width: 21.5 Depth: 25.5 Height: 40

AH: 0 SH: 19 SD: 19 IW: 21.5

Weight: 18 lbs Cube: 15.74

D	E	F	G	H	J	K COM	L	M	N	O	P	Q	R	S	T	U	(# above U) *	S Nail	M Nail
1095	1104	1113	1122	1131	1140	1149	1158	1167	1176	1185	1194	1203	1212	1221	1230	1239	9 (Riser) + 1239 (U)	45	N/A
Leather 1 N/A		Leather 2 N/A		Leather 3 N/A		Leather 4 N/A		Leather 5 N/A		Leather 6 N/A		Leather 8 N/A		COL N/A		S Nail N/A		M Nail N/A	

Upholstery

**Pillows are not available on leather SKUs*

Fabric SKU: **8817-05**

Leather SKU: **L-8817-05**

Standard Pillows: N/A Finish Req: Y

Standard Cushions: High Resiliency 40 Standard Finish:

COM: 3.5 yards COL: 45 square feet

Lucy Side Chair

Width: 21.5 Depth: 25.5 Height: 40

AH: 0 SH: 19 SD: 19 IW: 21.5

Weight: 18 lbs Cube: 15.74

D	E	F	G	H	J	K COM	L	M	N	O	P	Q	R	S	T	U	(# above U) *	S Nail	M Nail
1140	1149	1158	1167	1176	1185	1194	1203	1212	1221	1230	1239	1248	1257	1266	1275	1284	9 (Riser) + 1284 (U)	Std.	N/A
Leather 1 1890		Leather 2 1965		Leather 3 2040		Leather 4 2115		Leather 5 2190		Leather 6 2265		Leather 8 2895		COL 1212		S Nail Std.		M Nail N/A	

Fabric SKU: **8819-04**

Leather SKU: **L-8819-04**

Standard Pillows: N/A Finish Req: Y

Standard Cushions: High Resiliency 40 Standard Finish:

COM: 2 yards COL: 40 square feet

Kennedy Arm Chair

Width: 24 Depth: 25.5 Height: 38.25

AH: 25.5 SH: 19.5 SD: 19 IW: 20.25

Weight: 32 lbs Cube: 15.74

D	E	F	G	H	J	K COM	L	M	N	O	P	Q	R	S	T	U	(# above U) *	S Nail	M Nail
1125	1131	1137	1143	1149	1155	1161	1167	1173	1179	1185	1191	1197	1203	1209	1215	1221	6 (Riser) + 1221 (U)	45	N/A
Leather 1 1545		Leather 2 1605		Leather 3 1665		Leather 4 1725		Leather 5 1785		Leather 6 1845		Leather 8 2400		COL 1173		S Nail 45		M Nail N/A	

Fabric SKU: **8819-05**

Leather SKU: **L-8819-05**

Standard Pillows: N/A Finish Req: Y

Standard Cushions: High Resiliency 40 Standard Finish:

COM: 2 yards COL: 38 square feet

Kennedy Side Chair

Width: 24.5 Depth: 25.25 Height: 38.25

AH: 0 SH: 19.5 SD: 19 IW: 24.5

Weight: 30 lbs Cube: 15.74

D	E	F	G	H	J	K COM	L	M	N	O	P	Q	R	S	T	U	(# above U) *	S Nail	M Nail
1050	1056	1062	1068	1074	1080	1086	1092	1098	1104	1110	1116	1122	1128	1134	1140	1146	6 (Riser) + 1146 (U)	45	N/A
Leather 1 1485		Leather 2 1545		Leather 3 1605		Leather 4 1665		Leather 5 1725		Leather 6 1785		Leather 8 2310		COL 1098		S Nail 45		M Nail N/A	

Fabric SKU: **8819-A2**

Leather SKU: **L-8819-A2**

Standard Pillows: N/A Finish Req: Y

Standard Cushions: High Resiliency 40 Standard Finish:

COM: 2 yards COL: 40 square feet

Kennedy Arm Chair

Width: 24 Depth: 25.5 Height: 38.25

AH: 25.5 SH: 19.5 SD: 19 IW: 20.25

Weight: 32 lbs Cube: 15.74

D	E	F	G	H	J	K COM	L	M	N	O	P	Q	R	S	T	U	(# above U) *	S Nail	M Nail
1161	1167	1173	1179	1185	1191	1197	1203	1209	1215	1221	1227	1233	1239	1245	1251	1257	6 (Riser) + 1257 (U)	45	N/A
Leather 1 1575		Leather 2 1635		Leather 3 1695		Leather 4 1755		Leather 5 1815		Leather 6 1875		Leather 8 2430		COL 1209		S Nail 45		M Nail N/A	

Fabric SKU: **8819-A4**

Leather SKU: **L-8819-A4**

Standard Pillows: N/A Finish Req: Y

Standard Cushions: High Resiliency 40 Standard Finish:

COM: 2 yards COL: 40 square feet

Kennedy Arm Chair

Width: 24 Depth: 25.5 Height: 38.25

AH: 25.5 SH: 19.5 SD: 19 IW: 20.25

Weight: 32 lbs Cube: 15.74

D	E	F	G	H	J	K COM	L	M	N	O	P	Q	R	S	T	U	(# above U) *	S Nail	M Nail
1197	1203	1209	1215	1221	1227	1233	1239	1245	1251	1257	1263	1269	1275	1281	1287	1293	6 (Riser) + 1293 (U)	45	N/A
Leather 1 1620		Leather 2 1680		Leather 3 1740		Leather 4 1800		Leather 5 1860		Leather 6 1920		Leather 8 2475		COL 1245		S Nail 45		M Nail N/A	

Fabric SKU: **8821-05**

Leather SKU: **L-8821-05**

Standard Pillows: N/A Finish Req: Y

Standard Cushions: High Resiliency 40 Standard Finish:

COM: 2 yards COL: 34.2 square feet

Clayton Side Chair

Width: 20 Depth: 27 Height: 38

AH: 0 SH: 19.5 SD: 20.25 IW: 20

Weight: 19 lbs Cube: 21.65

D	E	F	G	H	J	K COM	L	M	N	O	P	Q	R	S	T	U	(# above U) *	S Nail	M Nail
1422	1428	1434	1440	1446	1452	1458	1464	1470	1476	1482	1488	1494	1500	1506	1512	1518	6 (Riser) + 1518 (U)	45	N/A
Leather 1 1920		Leather 2 1980		Leather 3 2040		Leather 4 2100		Leather 5 2160		Leather 6 2220		Leather 8 2700		COL 1470		S Nail 45		M Nail N/A	

Upholstery

**Pillows are not available on leather SKUs*

Fabric SKU: **8822-04**

Leather SKU: **L-8822-04**

Standard Pillows: N/A Finish Req: Y

Standard Cushions: High Resiliency 40 Standard Finish:

COM: 2.75 yards COL: 51 square feet

Macey Arm Chair

Width: 25 Depth: 26 Height: 36.5
 AH: 23.5 SH: 19.25 SD: 19 IW: 20
 Weight: 31 lbs Cube: 21.65

D	E	F	G	H	J	K COM	L	M	N	O	P	Q	R	S	T	U	(# above U) *	S Nail	M Nail
1710	1719	1728	1737	1746	1755	1764	1773	1782	1791	1800	1809	1818	1827	1836	1845	1854	9 (Riser) + 1854 (U)	45	N/A
Leather 1 2475		Leather 2 2550		Leather 3 2625		Leather 4 2700		Leather 5 2775		Leather 6 2850		Leather 8 3555		COL 1782		S Nail 45		M Nail N/A	

Fabric SKU: **8822-A2**

Leather SKU: **N/A**

Standard Pillows: N/A Finish Req: Y

Standard Cushions: High Resiliency 40 Standard Finish:

COM: 2.75 yards COL: N/A

Macey Arm Chair

Width: 25 Depth: 26 Height: 36.5
 AH: 23.5 SH: 19.25 SD: 19 IW: 20
 Weight: 31 lbs Cube: 21.65

D	E	F	G	H	J	K COM	L	M	N	O	P	Q	R	S	T	U	(# above U) *	S Nail	M Nail
1746	1755	1764	1773	1782	1791	1800	1809	1818	1827	1836	1845	1854	1863	1872	1881	1890	9 (Riser) + 1890 (U)	45	N/A
Leather 1 N/A		Leather 2 N/A		Leather 3 N/A		Leather 4 N/A		Leather 5 N/A		Leather 6 N/A		Leather 8 N/A		COL N/A		S Nail N/A		M Nail N/A	

Fabric SKU: **8823-05**

Leather SKU: **L-8823-05**

Standard Pillows: N/A Finish Req: Y

Standard Cushions: High Resiliency 40 Standard Finish:

COM: 2.75 yards COL: 51 square feet

Josephine Side Chair

Width: 20 Depth: 25.5 Height: 40.25
 AH: 0 SH: 19.5 SD: 19 IW: 0
 Weight: 17 lbs Cube: 15.74

D	E	F	G	H	J	K COM	L	M	N	O	P	Q	R	S	T	U	(# above U) *	S Nail	M Nail
1140	1149	1158	1167	1176	1185	1194	1203	1212	1221	1230	1239	1248	1257	1266	1275	1284	9 (Riser) + 1284 (U)	Std.	N/A
Leather 1 1815		Leather 2 1890		Leather 3 1965		Leather 4 2040		Leather 5 2115		Leather 6 2190		Leather 8 2895		COL 1212		S Nail Std.		M Nail N/A	

Fabric SKU: **8833-04**

Leather SKU: **L-8833-04**

Standard Pillows: N/A Finish Req: Y

Standard Cushions: High Resiliency 40 Standard Finish:

COM: 2 yards COL: 40 square feet

Mcgee Arm Chair

Width: 25 Depth: 25.75 Height: 40.25
 AH: 25 SH: 20 SD: 19.75 IW: 21.75
 Weight: 20 lbs Cube: 17.77

D	E	F	G	H	J	K COM	L	M	N	O	P	Q	R	S	T	U	(# above U) *	S Nail	M Nail
1365	1371	1377	1383	1389	1395	1401	1407	1413	1419	1425	1431	1437	1443	1449	1455	1461	6 (Riser) + 1461 (U)	N/A	N/A
Leather 1 1815		Leather 2 1875		Leather 3 1935		Leather 4 1995		Leather 5 2055		Leather 6 2115		Leather 8 2670		COL 1413		S Nail N/A		M Nail N/A	

Fabric SKU: **8835-04**

Leather SKU: **L-8835-04**

Standard Pillows: N/A Finish Req: Y

Standard Cushions: High Resiliency 30 Standard Finish:

COM: 2 yards COL: 40 square feet

Mateo Dining Chair

Width: 27 Depth: 22 Height: 28.5
 AH: 28.5 SH: 19 SD: 18 IW: 17.5
 Weight: 23 lbs Cube: 9.79

D	E	F	G	H	J	K COM	L	M	N	O	P	Q	R	S	T	U	(# above U) *	S Nail	M Nail
1395	1404	1413	1422	1431	1440	1449	1458	1467	1476	1485	1494	1503	1512	1521	1530	1539	9 (Riser) + 1539 (U)	N/A	N/A
Leather 1 1875		Leather 2 1935		Leather 3 1995		Leather 4 2055		Leather 5 2115		Leather 6 2175		Leather 8 2730		COL 1467		S Nail N/A		M Nail N/A	

Fabric SKU: **8840-04**

Leather SKU: **L-8840-04**

Standard Pillows: N/A Finish Req: Y

Standard Cushions: High Resiliency 40 Standard Finish:

COM: 2 yards COL: 34.2 square feet

Lila Arm Chair

Width: 22.25 Depth: 24.5 Height: 39
 AH: 24.25 SH: 19 SD: 18.5 IW: 18.5
 Weight: 19 lbs Cube: 15.74

D	E	F	G	H	J	K COM	L	M	N	O	P	Q	R	S	T	U	(# above U) *	S Nail	M Nail
1350	1356	1362	1368	1374	1380	1386	1392	1398	1404	1410	1416	1422	1428	1434	1440	1446	6 (Riser) + 1446 (U)	45	N/A
Leather 1 1815		Leather 2 1875		Leather 3 1935		Leather 4 1995		Leather 5 2055		Leather 6 2115		Leather 8 2595		COL 1398		S Nail 45		M Nail N/A	

Upholstery

**Pillows are not available on leather SKUs*

Fabric SKU: **8840-05**

Leather SKU: **L-8840-05**

Standard Pillows: N/A **Finish Req:** Y

Standard Cushions: High Resiliency 40 **Standard Finish:**

COM: 2 yards **COL:** 34 square feet

Lila Side Chair

Width: 23.25 **Depth:** 24.5 **Height:** 39

AH: 0 **SH:** 19 **SD:** 18.5 **IW:** 23.75

Weight: 17 lbs **Cube:** 15.74

D	E	F	G	H	J	K COM	L	M	N	O	P	Q	R	S	T	U	(# above U) *	S Nail	M Nail
1320	1326	1332	1338	1344	1350	1356	1362	1368	1374	1380	1386	1392	1398	1404	1410	1416	6 (Riser) + 1416 (U)	45	N/A
Leather 1 1785		Leather 2 1845		Leather 3 1905		Leather 4 1965		Leather 5 2025		Leather 6 2085		Leather 8 2550		COL 1368		S Nail 45		M Nail N/A	

Fabric SKU: **8842-04**

Leather SKU: **L-8842-04**

Standard Pillows: N/A **Finish Req:** Y

Standard Cushions: High Resiliency 40 **Standard Finish:**

COM: 2 yards **COL:** 34.2 square feet

Ava Arm Chair

Width: 22.5 **Depth:** 25.75 **Height:** 40.5

AH: 24.5 **SH:** 19.5 **SD:** 20 **IW:** 20

Weight: 16 lbs **Cube:** 17.77

Features natural cane accents that was handwoven using the peel of natural rattan. As with any natural product, nature's imperfections and hallmarks will be present in the cane materials. Cane is a handcrafted product dating back to the Ancient Egyptians.

D	E	F	G	H	J	K COM	L	M	N	O	P	Q	R	S	T	U	(# above U) *	S Nail	M Nail
1290	1296	1302	1308	1314	1320	1326	1332	1338	1344	1350	1356	1362	1368	1374	1380	1386	6 (Riser) + 1386 (U)	45	N/A
Leather 1 1740		Leather 2 1800		Leather 3 1860		Leather 4 1920		Leather 5 1980		Leather 6 2040		Leather 8 2520		COL 1338		S Nail 45		M Nail N/A	

Fabric SKU: **8842-05**

Leather SKU: **L-8842-05**

Standard Pillows: N/A **Finish Req:** Y

Standard Cushions: High Resiliency 40 **Standard Finish:**

COM: 2 yards **COL:** 34.2 square feet

Ava Side Chair

Width: 22.5 **Depth:** 25.75 **Height:** 40.5

AH: 24.5 **SH:** 19.5 **SD:** 20 **IW:** 20

Weight: 16 lbs **Cube:** 15.74

Features natural cane accents that was handwoven using the peel of natural rattan. As with any natural product, nature's imperfections and hallmarks will be present in the cane materials. Cane is a handcrafted product dating back to the Ancient Egyptians.

D	E	F	G	H	J	K COM	L	M	N	O	P	Q	R	S	T	U	(# above U) *	S Nail	M Nail
1260	1266	1272	1278	1284	1290	1296	1302	1308	1314	1320	1326	1332	1338	1344	1350	1356	6 (Riser) + 1356 (U)	45	N/A
Leather 1 1710		Leather 2 1770		Leather 3 1830		Leather 4 1890		Leather 5 1950		Leather 6 2010		Leather 8 2490		COL 1308		S Nail 45		M Nail N/A	

Fabric SKU: **8846-04**

Leather SKU: **L-8846-04**

Standard Pillows: N/A **Finish Req:** Y

Standard Cushions: High Resiliency 40 **Standard Finish:**

COM: 1.5 yards **COL:** 27 square feet

Larson Arm Chair

Width: 21.25 **Depth:** 24.5 **Height:** 34.75

AH: 25.25 **SH:** 20.5 **SD:** 20 **IW:** 19

Weight: 17 lbs **Cube:** 15.74

Features natural cane accents that was handwoven using the peel of natural rattan. As with any natural product, nature's imperfections and hallmarks will be present in the cane materials. Cane is a handcrafted product dating back to the Ancient Egyptians.

D	E	F	G	H	J	K COM	L	M	N	O	P	Q	R	S	T	U	(# above U) *	S Nail	M Nail
1050	1056	1062	1068	1074	1080	1086	1092	1098	1104	1110	1116	1122	1128	1134	1140	1146	6 (Riser) + 1146 (U)	N/A	N/A
Leather 1 1350		Leather 2 1395		Leather 3 1440		Leather 4 1485		Leather 5 1530		Leather 6 1575		Leather 8 1950		COL 1098		S Nail N/A		M Nail N/A	

Fabric SKU: **8846-05**

Leather SKU: **L-8846-05**

Standard Pillows: N/A **Finish Req:** Y

Standard Cushions: High Resiliency 40 **Standard Finish:**

COM: 1.5 yards **COL:** 27 square feet

Larson Side Chair

Width: 20 **Depth:** 24.5 **Height:** 34.75

AH: 0 **SH:** 20.5 **SD:** 20 **IW:** 0

Weight: 16 lbs **Cube:** 15.74

Features natural cane accents that was handwoven using the peel of natural rattan. As with any natural product, nature's imperfections and hallmarks will be present in the cane materials. Cane is a handcrafted product dating back to the Ancient Egyptians.

D	E	F	G	H	J	K COM	L	M	N	O	P	Q	R	S	T	U	(# above U) *	S Nail	M Nail
1020	1026	1032	1038	1044	1050	1056	1062	1068	1074	1080	1086	1092	1098	1104	1110	1116	6 (Riser) + 1116 (U)	N/A	N/A
Leather 1 1320		Leather 2 1365		Leather 3 1410		Leather 4 1455		Leather 5 1500		Leather 6 1545		Leather 8 1920		COL 1068		S Nail N/A		M Nail N/A	

Fabric SKU: **8847-04**

Leather SKU: **L-8847-04**

Standard Pillows: N/A **Finish Req:** Y

Standard Cushions: High Resiliency 40 **Standard Finish:**

COM: 2 yards **COL:** 40 square feet

Catherine Arm Chair

Width: 23.25 **Depth:** 24.5 **Height:** 37.75

AH: 25.25 **SH:** 19.25 **SD:** 19.25 **IW:** 19.25

Weight: 22 lbs **Cube:** 15.74

Features natural cane accents that was handwoven using the peel of natural rattan. As with any natural product, nature's imperfections and hallmarks will be present in the cane materials. Cane is a handcrafted product dating back to the Ancient Egyptians.

D	E	F	G	H	J	K COM	L	M	N	O	P	Q	R	S	T	U	(# above U) *	S Nail	M Nail
1125	1131	1137	1143	1149	1155	1161	1167	1173	1179	1185	1191	1197	1203	1209	1215	1221	6 (Riser) + 1221 (U)	75	N/A
Leather 1 1545		Leather 2 1605		Leather 3 1665		Leather 4 1725		Leather 5 1785		Leather 6 1845		Leather 8 2400		COL 1173		S Nail 75		M Nail N/A	

Upholstery

**Pillows are not available on leather SKUs*

Fabric SKU: **8847-A4**

Leather SKU: **L-8847-A4**

Standard Pillows: N/A Finish Req: Y

Standard Cushions: High Resiliency 40 Standard Finish:

COM: 2 yards COL: 40 square feet

Catherine Arm Chair

Width: 23.25 Depth: 24.5 Height: 37.75
 AH: 25.25 SH: 19.25 SD: 19.25 IW: 19.25
 Weight: 22 lbs Cube: 15.74

D	E	F	G	H	J	K COM	L	M	N	O	P	Q	R	S	T	U	(# above U) *	S Nail	M Nail
1197	1203	1209	1215	1221	1227	1233	1239	1245	1251	1257	1263	1269	1275	1281	1287	1293	6 (Riser) + 1293 (U)	75	N/A
Leather 1 1620		Leather 2 1680		Leather 3 1740		Leather 4 1800		Leather 5 1860		Leather 6 1920		Leather 8 2475		COL 1245		S Nail 75		M Nail N/A	

Fabric SKU: **8849-04**

Leather SKU: **L-8849-04**

Standard Pillows: N/A Finish Req: Y

Standard Cushions: High Resiliency 40 Standard Finish:

COM: 2 yards COL: 40 square feet

Features a hidden handle

Rocco Arm Chair

Width: 22 Depth: 24.5 Height: 35.5
 AH: 25 SH: 20.25 SD: 19 IW: 19.75
 Weight: 32 lbs Cube: 15.74

D	E	F	G	H	J	K COM	L	M	N	O	P	Q	R	S	T	U	(# above U) *	S Nail	M Nail
1320	1326	1332	1338	1344	1350	1356	1362	1368	1374	1380	1386	1392	1398	1404	1410	1416	6 (Riser) + 1416 (U)	N/A	N/A
Leather 1 1830		Leather 2 1890		Leather 3 1950		Leather 4 2010		Leather 5 2070		Leather 6 2130		Leather 8 2685		COL 1368		S Nail N/A		M Nail N/A	

Fabric SKU: **8849-05**

Leather SKU: **L-8849-05**

Standard Pillows: N/A Finish Req: Y

Standard Cushions: High Resiliency 40 Standard Finish:

COM: 2 yards COL: 40 square feet

Features a hidden handle

Rocco Dining Chair

Width: 20.75 Depth: 24.5 Height: 35.25
 AH: 0 SH: 20 SD: 18.75 IW: 20.75
 Weight: 21 lbs Cube: 10.37

D	E	F	G	H	J	K COM	L	M	N	O	P	Q	R	S	T	U	(# above U) *	S Nail	M Nail
1275	1281	1287	1293	1299	1305	1311	1317	1323	1329	1335	1341	1347	1353	1359	1365	1371	6 (Riser) + 1371 (U)	N/A	N/A
Leather 1 1785		Leather 2 1845		Leather 3 1905		Leather 4 1965		Leather 5 2025		Leather 6 2085		Leather 8 2640		COL 1323		S Nail N/A		M Nail N/A	

Fabric SKU: **8849-06**

Leather SKU: **L-8849-06**

Standard Pillows: N/A Finish Req: Y

Standard Cushions: High Resiliency 40 Standard Finish:

COM: 2 yards COL: 29 square feet

Features a hidden handle

Rocco Bar Stool

Width: 21.25 Depth: 24 Height: 44.5
 AH: 36 SH: 30.5 SD: 19 IW: 21.25
 Weight: 25 lbs Cube: 17.77

D	E	F	G	H	J	K COM	L	M	N	O	P	Q	R	S	T	U	(# above U) *	S Nail	M Nail
1650	1656	1662	1668	1674	1680	1686	1692	1698	1704	1710	1716	1722	1728	1734	1740	1746	6 (Riser) + 1746 (U)	N/A	N/A
Leather 1 2070		Leather 2 2115		Leather 3 2160		Leather 4 2205		Leather 5 2250		Leather 6 2295		Leather 8 2700		COL 1698		S Nail N/A		M Nail N/A	

Fabric SKU: **8849-07**

Leather SKU: **L-8849-07**

Standard Pillows: N/A Finish Req: Y

Standard Cushions: High Resiliency 40 Standard Finish:

COM: 2 yards COL: 29 square feet

Features a hidden handle

Rocco Bar Stool

Width: 21.25 Depth: 24 Height: 44.5
 AH: 0 SH: 30.5 SD: 19 IW: 21.25
 Weight: 23 lbs Cube: 17.77

D	E	F	G	H	J	K COM	L	M	N	O	P	Q	R	S	T	U	(# above U) *	S Nail	M Nail
1590	1596	1602	1608	1614	1620	1626	1632	1638	1644	1650	1656	1662	1668	1674	1680	1686	6 (Riser) + 1686 (U)	N/A	N/A
Leather 1 2025		Leather 2 2070		Leather 3 2115		Leather 4 2160		Leather 5 2205		Leather 6 2250		Leather 8 2655		COL 1638		S Nail N/A		M Nail N/A	

Fabric SKU: **8849-A2**

Leather SKU: **L-8849-A2**

Standard Pillows: N/A Finish Req: Y

Standard Cushions: High Resiliency 40 Standard Finish:

COM: 2 yards COL: 40 square feet

Standard with 2 front casters and features a hidden handle

Rocco Arm Chair

Width: 22 Depth: 24.5 Height: 35.5
 AH: 25 SH: 20.25 SD: 19 IW: 19.75
 Weight: 32 lbs Cube: 15.74

D	E	F	G	H	J	K COM	L	M	N	O	P	Q	R	S	T	U	(# above U) *	S Nail	M Nail
1356	1362	1368	1374	1380	1386	1392	1398	1404	1410	1416	1422	1428	1434	1440	1446	1452	6 (Riser) + 1452 (U)	N/A	N/A
Leather 1 1860		Leather 2 1920		Leather 3 1980		Leather 4 2040		Leather 5 2100		Leather 6 2160		Leather 8 2715		COL 1404		S Nail N/A		M Nail N/A	

Upholstery

**Pillows are not available on leather SKUs*

Fabric SKU: **8849-A4**

Leather SKU: **L-8849-A4**

Standard Pillows: N/A Finish Req: Y

Standard Cushions: High Resiliency 40 Standard Finish:

COM: 2 yards COL: 40 square feet

Standard with casters on all legs and features a hidden handle

Rocco Arm Chair

Width: 22 Depth: 24.5 Height: 35.5

AH: 25 SH: 20.25 SD: 19 IW: 19.75

Weight: 32 lbs Cube: 11.07

D	E	F	G	H	J	K COM	L	M	N	O	P	Q	R	S	T	U	(# above U) *	S Nail	M Nail
1392	1398	1404	1410	1416	1422	1428	1434	1440	1446	1452	1458	1464	1470	1476	1482	1488	6 (Riser) + 1488 (U)	N/A	N/A
Leather 1 1905		Leather 2 1965		Leather 3 2025		Leather 4 2085		Leather 5 2145		Leather 6 2205		Leather 8 2760		COL 1440		S Nail N/A		M Nail N/A	

Fabric SKU: **8849-C6**

Leather SKU: **L-8849-C6**

Standard Pillows: N/A Finish Req: Y

Standard Cushions: High Resiliency 40 Standard Finish:

COM: 2 yards COL: 29 square feet

Features a hidden handle

Rocco Counter Stool

Width: 21.25 Depth: 24 Height: 40.5

AH: 32 SH: 26.5 SD: 19 IW: 21.25

Weight: 25 lbs Cube: 17.77

D	E	F	G	H	J	K COM	L	M	N	O	P	Q	R	S	T	U	(# above U) *	S Nail	M Nail
1650	1656	1662	1668	1674	1680	1686	1692	1698	1704	1710	1716	1722	1728	1734	1740	1746	6 (Riser) + 1746 (U)	N/A	N/A
Leather 1 2070		Leather 2 2115		Leather 3 2160		Leather 4 2205		Leather 5 2250		Leather 6 2295		Leather 8 2700		COL 1698		S Nail N/A		M Nail N/A	

Fabric SKU: **8849-C7**

Leather SKU: **L-8849-C7**

Standard Pillows: N/A Finish Req: Y

Standard Cushions: High Resiliency 40 Standard Finish:

COM: 2 yards COL: 29 square feet

Features a hidden handle

Rocco Counter Stool

Width: 21.25 Depth: 24 Height: 40.5

AH: 0 SH: 26.5 SD: 19 IW: 21.25

Weight: 23 lbs Cube: 15.74

D	E	F	G	H	J	K COM	L	M	N	O	P	Q	R	S	T	U	(# above U) *	S Nail	M Nail
1590	1596	1602	1608	1614	1620	1626	1632	1638	1644	1650	1656	1662	1668	1674	1680	1686	6 (Riser) + 1686 (U)	N/A	N/A
Leather 1 2025		Leather 2 2070		Leather 3 2115		Leather 4 2160		Leather 5 2205		Leather 6 2250		Leather 8 2655		COL 1638		S Nail N/A		M Nail N/A	

Fabric SKU: **8850-04**

Leather SKU: **L-8850-04**

Standard Pillows: N/A Finish Req: Y

Standard Cushions: High Resiliency 40 Standard Finish:

COM: 2 yards COL: 40 square feet

Features a notched opening at the top back edge which provides a convenient holding spot.

Apollo Arm Chair

Width: 23.25 Depth: 25 Height: 37.25

AH: 25 SH: 20 SD: 19 IW: 20.25

Weight: 30 lbs Cube: 15.74

D	E	F	G	H	J	K COM	L	M	N	O	P	Q	R	S	T	U	(# above U) *	S Nail	M Nail
1362	1368	1374	1380	1386	1392	1398	1404	1410	1416	1422	1428	1434	1440	1446	1452	1458	6 (Riser) + 1458 (U)	N/A	N/A
Leather 1 1890		Leather 2 1950		Leather 3 2010		Leather 4 2070		Leather 5 2130		Leather 6 2190		Leather 8 2745		COL 1410		S Nail N/A		M Nail N/A	

Fabric SKU: **8851-04**

Leather SKU: **L-8851-04**

Standard Pillows: N/A Finish Req: Y

Standard Cushions: High Resiliency 40 Standard Finish:

COM: 2 yards COL: 40 square feet

Big Sur Arm Chair

Width: 24 Depth: 27 Height: 37.5

AH: 25.25 SH: 20 SD: 21 IW: 20.25

Weight: 36 lbs Cube: 15.74

D	E	F	G	H	J	K COM	L	M	N	O	P	Q	R	S	T	U	(# above U) *	S Nail	M Nail
1320	1326	1332	1338	1344	1350	1356	1362	1368	1374	1380	1386	1392	1398	1404	1410	1416	6 (Riser) + 1416 (U)	N/A	N/A
Leather 1 1815		Leather 2 1875		Leather 3 1935		Leather 4 1995		Leather 5 2055		Leather 6 2115		Leather 8 2670		COL 1368		S Nail N/A		M Nail N/A	

Fabric SKU: **8851-A2**

Leather SKU: **L-8851-A2**

Standard Pillows: N/A Finish Req: Y

Standard Cushions: High Resiliency 40 Standard Finish:

COM: 2 yards COL: 40 square feet

Big Sur Arm Chair

Width: 24 Depth: 27 Height: 37.5

AH: 25.25 SH: 20 SD: 21 IW: 20.25

Weight: 36 lbs Cube: 15.74

D	E	F	G	H	J	K COM	L	M	N	O	P	Q	R	S	T	U	(# above U) *	S Nail	M Nail
1356	1362	1368	1374	1380	1386	1392	1398	1404	1410	1416	1422	1428	1434	1440	1446	1452	6 (Riser) + 1452 (U)	N/A	N/A
Leather 1 1845		Leather 2 1905		Leather 3 1965		Leather 4 2025		Leather 5 2085		Leather 6 2145		Leather 8 2700		COL 1404		S Nail N/A		M Nail N/A	

Upholstery

**Pillows are not available on leather SKUs*

Fabric SKU: **8851-A4**

Leather SKU: **L-8851-A4**

Standard Pillows: N/A **Finish Req:** Y

Standard Cushions: High Resiliency 40 **Standard Finish:**

COM: 2 yards **COL:** 40 square feet

Big Sur Arm Chair

Width: 24 **Depth:** 27 **Height:** 37.5
AH: 25.25 **SH:** 20 **SD:** 21 **IW:** 20.25
Weight: 36 lbs **Cube:** 15.74

D	E	F	G	H	J	K COM	L	M	N	O	P	Q	R	S	T	U	(# above U) *	S Nail	M Nail
1392	1398	1404	1410	1416	1422	1428	1434	1440	1446	1452	1458	1464	1470	1476	1482	1488	6 (Riser) + 1488 (U)	N/A	N/A
Leather 1 1890		Leather 2 1950		Leather 3 2010		Leather 4 2070		Leather 5 2130		Leather 6 2190		Leather 8 2745		COL 1440		S Nail N/A		M Nail N/A	

Fabric SKU: **8852-05**

Leather SKU: **L-8852-05**

Standard Pillows: N/A **Finish Req:** Y

Standard Cushions: High Resiliency 40 **Standard Finish:**

COM: 3.25 yards **COL:** 62 square feet

Trenton Side Chair

Width: 22.5 **Depth:** 26.5 **Height:** 41.25
AH: 0 **SH:** 19.5 **SD:** 18.5 **IW:** 19
Weight: 32 lbs **Cube:** 15.74

D	E	F	G	H	J	K COM	L	M	N	O	P	Q	R	S	T	U	(# above U) *	S Nail	M Nail
1620	1629	1638	1647	1656	1665	1674	1683	1692	1701	1710	1719	1728	1737	1746	1755	1764	9 (Riser) + 1764 (U)	90	N/A
Leather 1 2475		Leather 2 2580		Leather 3 2685		Leather 4 2790		Leather 5 2895		Leather 6 3000		Leather 8 3855		COL 1692		S Nail 90		M Nail N/A	

Fabric SKU: **8852-05-2**

Leather SKU: **L-8852-05-2**

Standard Pillows: N/A **Finish Req:** Y

Standard Cushions: High Resiliency 40 **Standard Finish:**

COM: 3.25 yards **COL:** 62 square feet

Standard with a Satin Nickel Ring Pull.

Trenton Side Chair

Width: 22.5 **Depth:** 26.5 **Height:** 41.25
AH: 0 **SH:** 19.5 **SD:** 18.5 **IW:** 19
Weight: 32 lbs **Cube:** 17.77

D	E	F	G	H	J	K COM	L	M	N	O	P	Q	R	S	T	U	(# above U) *	S Nail	M Nail
1650	1659	1668	1677	1686	1695	1704	1713	1722	1731	1740	1749	1758	1767	1776	1785	1794	9 (Riser) + 1794 (U)	90	N/A
Leather 1 2505		Leather 2 2610		Leather 3 2715		Leather 4 2820		Leather 5 2925		Leather 6 3030		Leather 8 3885		COL 1722		S Nail 90		M Nail N/A	

Fabric SKU: **8852-05-6**

Leather SKU: **L-8852-05-6**

Standard Pillows: N/A **Finish Req:** Y

Standard Cushions: High Resiliency 40 **Standard Finish:**

COM: 3.25 yards **COL:** 62 square feet

Standard with a Brushed Brass Ring Pull.

Trenton Side Chair

Width: 22.5 **Depth:** 26.5 **Height:** 41.25
AH: 0 **SH:** 19.5 **SD:** 18.5 **IW:** 19
Weight: 32 lbs **Cube:** 17.77

D	E	F	G	H	J	K COM	L	M	N	O	P	Q	R	S	T	U	(# above U) *	S Nail	M Nail
1650	1659	1668	1677	1686	1695	1704	1713	1722	1731	1740	1749	1758	1767	1776	1785	1794	9 (Riser) + 1794 (U)	90	N/A
Leather 1 2505		Leather 2 2610		Leather 3 2715		Leather 4 2820		Leather 5 2925		Leather 6 3030		Leather 8 3885		COL 1722		S Nail 90		M Nail N/A	

Fabric SKU: **8853-04**

Leather SKU: **L-8853-04**

Standard Pillows: N/A **Finish Req:** Y

Standard Cushions: High Resiliency 40 **Standard Finish:**

COM: 2 yards **COL:** 40 square feet

Features a notched opening at the top back edge which provides a convenient holding spot.

Reece Arm Chair

Width: 22.5 **Depth:** 25.5 **Height:** 37
AH: 25 **SH:** 20.5 **SD:** 20 **IW:** 19.5
Weight: 22 lbs **Cube:** 15.74

D	E	F	G	H	J	K COM	L	M	N	O	P	Q	R	S	T	U	(# above U) *	S Nail	M Nail
1197	1203	1209	1215	1221	1227	1233	1239	1245	1251	1257	1263	1269	1275	1281	1287	1293	6 (Riser) + 1293 (U)	N/A	N/A
Leather 1 1650		Leather 2 1710		Leather 3 1770		Leather 4 1830		Leather 5 1890		Leather 6 1950		Leather 8 2505		COL 1245		S Nail N/A		M Nail N/A	

Fabric SKU: **8853-06**

Leather SKU: **L-8853-06**

Standard Pillows: N/A **Finish Req:** Y

Standard Cushions: High Resiliency 40 **Standard Finish:**

COM: 2.5 yards **COL:** 40 square feet

Features a notched opening at the top back edge which provides a convenient holding spot.

Reece Bar Stool

Width: 20.5 **Depth:** 23.25 **Height:** 48.25
AH: 36 **SH:** 31 **SD:** 16.75 **IW:** 16.5
Weight: 21 lbs **Cube:** 19.6

D	E	F	G	H	J	K COM	L	M	N	O	P	Q	R	S	T	U	(# above U) *	S Nail	M Nail
1560	1569	1578	1587	1596	1605	1614	1623	1632	1641	1650	1659	1668	1677	1686	1695	1704	9 (Riser) + 1704 (U)	N/A	N/A
Leather 1 2055		Leather 2 2115		Leather 3 2175		Leather 4 2235		Leather 5 2295		Leather 6 2355		Leather 8 2910		COL 1632		S Nail N/A		M Nail N/A	

Upholstery

**Pillows are not available on leather SKUs*

Fabric SKU: **8853-A4**

Leather SKU: **L-8853-A4**

Standard Pillows: N/A **Finish Req:** Y

Standard Cushions: High Resiliency 40 **Standard Finish:**

COM: 2 yards **COL:** 40 square feet

Standard with casters on all legs and features a notched opening at the top back edge which provides a convenient holding spot.

Reece Arm Chair

Width: 22.5 **Depth:** 25.5 **Height:** 37

AH: 25 **SH:** 20.5 **SD:** 20 **IW:** 19.5

Weight: 22 lbs **Cube:** 15.74

D	E	F	G	H	J	K COM	L	M	N	O	P	Q	R	S	T	U	(# above U) *	S Nail	M Nail
1269	1275	1281	1287	1293	1299	1305	1311	1317	1323	1329	1335	1341	1347	1353	1359	1365	6 (Riser) + 1365 (U)	N/A	N/A
Leather 1 1725		Leather 2 1785		Leather 3 1845		Leather 4 1905		Leather 5 1965		Leather 6 2025		Leather 8 2580		COL 1317		S Nail N/A		M Nail N/A	

Fabric SKU: **8853-C6**

Leather SKU: **L-8853-C6**

Standard Pillows: N/A **Finish Req:** Y

Standard Cushions: High Resiliency 40 **Standard Finish:**

COM: 2.5 yards **COL:** 40 square feet

Features a notched opening at the top back edge which provides a convenient holding spot.

Reece Counter Stool

Width: 20.5 **Depth:** 23.25 **Height:** 44.25

AH: 32 **SH:** 27 **SD:** 16.75 **IW:** 16.5

Weight: 21 lbs **Cube:** 17.77

D	E	F	G	H	J	K COM	L	M	N	O	P	Q	R	S	T	U	(# above U) *	S Nail	M Nail
1560	1569	1578	1587	1596	1605	1614	1623	1632	1641	1650	1659	1668	1677	1686	1695	1704	9 (Riser) + 1704 (U)	N/A	N/A
Leather 1 2055		Leather 2 2115		Leather 3 2175		Leather 4 2235		Leather 5 2295		Leather 6 2355		Leather 8 2910		COL 1632		S Nail N/A		M Nail N/A	

Fabric SKU: **8854-04**

Leather SKU: **L-8854-04**

Standard Pillows: N/A **Finish Req:** Y

Standard Cushions: High Resiliency 40 **Standard Finish:**

COM: 3.75 yards **COL:** 68 square feet

Cleo Arm Chair

Width: 22.5 **Depth:** 24.75 **Height:** 31.75

AH: 26 **SH:** 19.5 **SD:** 19.5 **IW:** 18

Weight: 30 lbs **Cube:** 15.74

D	E	F	G	H	J	K COM	L	M	N	O	P	Q	R	S	T	U	(# above U) *	S Nail	M Nail
1575	1587	1599	1611	1623	1635	1647	1659	1671	1683	1695	1707	1719	1731	1743	1755	1767	12 (Riser) + 1767 (U)	75	90
Leather 1 2325		Leather 2 2430		Leather 3 2535		Leather 4 2640		Leather 5 2745		Leather 6 2850		Leather 8 3795		COL 1671		S Nail 75		M Nail 90	

Fabric SKU: **8854-04-M**

Leather SKU: **N/A**

Standard Pillows: N/A **Finish Req:** N

Standard Cushions: High Resiliency 40 **Standard Finish:** Mica

COM: 3.75 yards **COL:** N/A

Our Clean Out seat design provides the caregiver access to easily and swiftly remove debris on a variety of Fairfield styles. We recognize that sanitation and cleaning are critical to the lifestyle of the community.

Cleo Grande Arm Chair

with Base in Mica Finish

Width: 22.5 **Depth:** 24.75 **Height:** 31.75

AH: 26 **SH:** 19.5 **SD:** 19.5 **IW:** 20

Weight: 30 lbs **Cube:** 10.23

D	E	F	G	H	J	K COM	L	M	N	O	P	Q	R	S	T	U	(# above U) *	S Nail	M Nail
1347	1359	1371	1383	1395	1407	1419	1431	1443	1455	1467	1479	1491	1503	1515	1527	1539	12 (Riser) + 1539 (U)	75	90
Leather 1 N/A		Leather 2 N/A		Leather 3 N/A		Leather 4 N/A		Leather 5 N/A		Leather 6 N/A		Leather 8 N/A		COL N/A		S Nail N/A		M Nail N/A	

Fabric SKU: **8854-06**

Leather SKU: **L-8854-06**

Standard Pillows: N/A **Finish Req:** Y

Standard Cushions: High Resiliency 40 **Standard Finish:**

COM: 3.75 yards **COL:** 68 square feet

Cleo Bar Stool

Width: 22.5 **Depth:** 24.75 **Height:** 42.75

AH: 37 **SH:** 30.5 **SD:** 19.5 **IW:** 18

Weight: 40 lbs **Cube:** 15.74

D	E	F	G	H	J	K COM	L	M	N	O	P	Q	R	S	T	U	(# above U) *	S Nail	M Nail
1875	1887	1899	1911	1923	1935	1947	1959	1971	1983	1995	2007	2019	2031	2043	2055	2067	12 (Riser) + 2067 (U)	75	90
Leather 1 2775		Leather 2 2880		Leather 3 2985		Leather 4 3090		Leather 5 3195		Leather 6 3300		Leather 8 4245		COL 1971		S Nail 75		M Nail 90	

Fabric SKU: **8854-10**

Leather SKU: **L-8854-10**

Standard Pillows: N/A **Finish Req:** Y

Standard Cushions: High Resiliency 40 **Standard Finish:**

COM: 5 yards **COL:** 79 square feet

Cleo Bench

Width: 52.5 **Depth:** 24.75 **Height:** 32

AH: 25.5 **SH:** 20 **SD:** 19.5 **IW:** 47.75

Weight: 52 lbs **Cube:** 24.06

D	E	F	G	H	J	K COM	L	M	N	O	P	Q	R	S	T	U	(# above U) *	S Nail	M Nail
2475	2490	2505	2520	2535	2550	2565	2580	2595	2610	2625	2640	2655	2670	2685	2700	2715	15 (Riser) + 2715 (U)	120	N/A
Leather 1 3375		Leather 2 3495		Leather 3 3615		Leather 4 3735		Leather 5 3855		Leather 6 3975		Leather 8 5070		COL 2595		S Nail 120		M Nail N/A	

Upholstery

**Pillows are not available on leather SKUs*

Fabric SKU: **8854-40**

Leather SKU: **L-8854-40**

Standard Pillows: N/A Finish Req: Y

Standard Cushions: High Resiliency 40 Standard Finish:

COM: 5.5 yards COL: 107 square feet

Cleo Settee

Width: 64.5 Depth: 24.75 Height: 32

AH: 25.5 SH: 20 SD: 19.5 IW: 59.5

Weight: 58 lbs Cube: 29.56

D	E	F	G	H	J	K COM	L	M	N	O	P	Q	R	S	T	U	(# above U) *	S Nail	M Nail
2685	2703	2721	2739	2757	2775	2793	2811	2829	2847	2865	2883	2901	2919	2937	2955	2973	18 (Riser) + 2973 (U)	135	N/A
Leather 1 3825		Leather 2 3990		Leather 3 4155		Leather 4 4320		Leather 5 4485		Leather 6 4650		Leather 8 6120		COL 2829		S Nail 135		M Nail N/A	

Fabric SKU: **8854-A2**

Leather SKU: **L-8854-A2**

Standard Pillows: N/A Finish Req: Y

Standard Cushions: High Resiliency 40 Standard Finish:

COM: 3.75 yards COL: 68 square feet

Standard with 2 front casters

Cleo Arm Chair

Width: 22.5 Depth: 24.75 Height: 31.75

AH: 26 SH: 19.5 SD: 19.5 IW: 18

Weight: 30 lbs Cube: 21.65

D	E	F	G	H	J	K COM	L	M	N	O	P	Q	R	S	T	U	(# above U) *	S Nail	M Nail
1611	1623	1635	1647	1659	1671	1683	1695	1707	1719	1731	1743	1755	1767	1779	1791	1803	12 (Riser) + 1803 (U)	75	90
Leather 1 2355		Leather 2 2460		Leather 3 2565		Leather 4 2670		Leather 5 2775		Leather 6 2880		Leather 8 3825		COL 1707		S Nail 75		M Nail 90	

Fabric SKU: **8854-A4**

Leather SKU: **L-8854-A4**

Standard Pillows: N/A Finish Req: Y

Standard Cushions: High Resiliency 40 Standard Finish:

COM: 3.75 yards COL: 68 square feet

Standard with casters on all legs

Cleo Arm Chair

Width: 22.5 Depth: 24.75 Height: 31.75

AH: 26 SH: 19.5 SD: 19.5 IW: 18

Weight: 30 lbs Cube: 21.65

D	E	F	G	H	J	K COM	L	M	N	O	P	Q	R	S	T	U	(# above U) *	S Nail	M Nail
1647	1659	1671	1683	1695	1707	1719	1731	1743	1755	1767	1779	1791	1803	1815	1827	1839	12 (Riser) + 1839 (U)	75	90
Leather 1 2400		Leather 2 2505		Leather 3 2610		Leather 4 2715		Leather 5 2820		Leather 6 2925		Leather 8 3870		COL 1743		S Nail 75		M Nail 90	

Fabric SKU: **8854-C6**

Leather SKU: **L-8854-C6**

Standard Pillows: N/A Finish Req: Y

Standard Cushions: High Resiliency 40 Standard Finish:

COM: 3.75 yards COL: 68 square feet

Cleo Counter Stool

Width: 22.5 Depth: 24.75 Height: 38.75

AH: 33 SH: 26.5 SD: 19.5 IW: 18

Weight: 40 lbs Cube: 12.48

D	E	F	G	H	J	K COM	L	M	N	O	P	Q	R	S	T	U	(# above U) *	S Nail	M Nail
1875	1887	1899	1911	1923	1935	1947	1959	1971	1983	1995	2007	2019	2031	2043	2055	2067	12 (Riser) + 2067 (U)	75	90
Leather 1 2775		Leather 2 2880		Leather 3 2985		Leather 4 3090		Leather 5 3195		Leather 6 3300		Leather 8 4245		COL 1971		S Nail 75		M Nail 90	

Fabric SKU: **8855-04**

Leather SKU: **L-8855-04**

Standard Pillows: N/A Finish Req: Y

Standard Cushions: High Resiliency 40 Standard Finish:

COM: 3.5 yards COL: 68 square feet

Josie Arm Chair

Width: 22.5 Depth: 25.5 Height: 36.5

AH: 25.75 SH: 19.5 SD: 19.5 IW: 18

Weight: 30 lbs Cube: 21.65

D	E	F	G	H	J	K COM	L	M	N	O	P	Q	R	S	T	U	(# above U) *	S Nail	M Nail
1575	1587	1599	1611	1623	1635	1647	1659	1671	1683	1695	1707	1719	1731	1743	1755	1767	12 (Riser) + 1767 (U)	75	90
Leather 1 2325		Leather 2 2430		Leather 3 2535		Leather 4 2640		Leather 5 2745		Leather 6 2850		Leather 8 3795		COL 1671		S Nail 75		M Nail 90	

Fabric SKU: **8855-06**

Leather SKU: **L-8855-06**

Standard Pillows: N/A Finish Req: Y

Standard Cushions: High Resiliency 40 Standard Finish:

COM: 3.5 yards COL: 68 square feet

Josie Bar Stool

Width: 22.5 Depth: 25.5 Height: 47.5

AH: 36.75 SH: 30.5 SD: 19.5 IW: 18

Weight: 40 lbs Cube: 15.77

D	E	F	G	H	J	K COM	L	M	N	O	P	Q	R	S	T	U	(# above U) *	S Nail	M Nail
1875	1887	1899	1911	1923	1935	1947	1959	1971	1983	1995	2007	2019	2031	2043	2055	2067	12 (Riser) + 2067 (U)	75	90
Leather 1 2775		Leather 2 2880		Leather 3 2985		Leather 4 3090		Leather 5 3195		Leather 6 3300		Leather 8 4245		COL 1971		S Nail 75		M Nail 90	

Upholstery

**Pillows are not available on leather SKUs*

Fabric SKU: **8855-10**

Leather SKU: **L-8855-10**

Standard Pillows: N/A Finish Req: Y

Standard Cushions: High Resiliency 40 Standard Finish:

COM: 5.5 yards COL: 96 square feet

Josie Bench

Width: 52.5 Depth: 25.5 Height: 36.75

AH: 25.5 SH: 20 SD: 19.5 IW: 47.5

Weight: 56 lbs Cube: 28.47

D	E	F	G	H	J	K COM	L	M	N	O	P	Q	R	S	T	U	(# above U) *	S Nail	M Nail
2475	2490	2505	2520	2535	2550	2565	2580	2595	2610	2625	2640	2655	2670	2685	2700	2715	15 (Riser) + 2715 (U)	150	N/A
Leather 1 3525		Leather 2 3675		Leather 3 3825		Leather 4 3975		Leather 5 4125		Leather 6 4275		Leather 8 5595		COL 2595		S Nail 120		M Nail N/A	

Fabric SKU: **8855-40**

Leather SKU: **L-8855-40**

Standard Pillows: N/A Finish Req: Y

Standard Cushions: High Resiliency 40 Standard Finish:

COM: 6.25 yards COL: 119 square feet

Josie Settee

Width: 64.5 Depth: 25.5 Height: 36.75

AH: 25.5 SH: 20 SD: 19.5 IW: 59.5

Weight: 61 lbs Cube: 34.97

D	E	F	G	H	J	K COM	L	M	N	O	P	Q	R	S	T	U	(# above U) *	S Nail	M Nail
2685	2703	2721	2739	2757	2775	2793	2811	2829	2847	2865	2883	2901	2919	2937	2955	2973	18 (Riser) + 2973 (U)	120	N/A
Leather 1 3975		Leather 2 4155		Leather 3 4335		Leather 4 4515		Leather 5 4695		Leather 6 4875		Leather 8 6510		COL 2829		S Nail 150		M Nail N/A	

Fabric SKU: **8855-A2**

Leather SKU: **L-8855-A2**

Standard Pillows: N/A Finish Req: Y

Standard Cushions: High Resiliency 40 Standard Finish:

COM: 3.5 yards COL: 68 square feet

Standard with 2 front casters

Josie Arm Chair

Width: 22.5 Depth: 25.5 Height: 36.5

AH: 25.75 SH: 19.5 SD: 19.5 IW: 18

Weight: 30 lbs Cube: 12.11

D	E	F	G	H	J	K COM	L	M	N	O	P	Q	R	S	T	U	(# above U) *	S Nail	M Nail
1611	1623	1635	1647	1659	1671	1683	1695	1707	1719	1731	1743	1755	1767	1779	1791	1803	12 (Riser) + 1803 (U)	75	90
Leather 1 2355		Leather 2 2460		Leather 3 2565		Leather 4 2670		Leather 5 2775		Leather 6 2880		Leather 8 3825		COL 1707		S Nail 75		M Nail 90	

Fabric SKU: **8855-A4**

Leather SKU: **L-8855-A4**

Standard Pillows: N/A Finish Req: Y

Standard Cushions: High Resiliency 40 Standard Finish:

COM: 3.5 yards COL: 68 square feet

Standard with casters on all legs

Josie Arm Chair

Width: 22.5 Depth: 25.5 Height: 36.5

AH: 25.75 SH: 19.5 SD: 19.5 IW: 18

Weight: 30 lbs Cube: 12.11

D	E	F	G	H	J	K COM	L	M	N	O	P	Q	R	S	T	U	(# above U) *	S Nail	M Nail
1647	1659	1671	1683	1695	1707	1719	1731	1743	1755	1767	1779	1791	1803	1815	1827	1839	12 (Riser) + 1839 (U)	75	90
Leather 1 2400		Leather 2 2505		Leather 3 2610		Leather 4 2715		Leather 5 2820		Leather 6 2925		Leather 8 3870		COL 1743		S Nail 75		M Nail 90	

Fabric SKU: **8855-C6**

Leather SKU: **L-8855-C6**

Standard Pillows: N/A Finish Req: Y

Standard Cushions: High Resiliency 40 Standard Finish:

COM: 3.5 yards COL: 68 square feet

Josie Counter Stool

Width: 22.5 Depth: 25.5 Height: 43.5

AH: 32.75 SH: 26.5 SD: 19.5 IW: 18

Weight: 40 lbs Cube: 19.6

D	E	F	G	H	J	K COM	L	M	N	O	P	Q	R	S	T	U	(# above U) *	S Nail	M Nail
1875	1887	1899	1911	1923	1935	1947	1959	1971	1983	1995	2007	2019	2031	2043	2055	2067	12 (Riser) + 2067 (U)	75	90
Leather 1 2775		Leather 2 2880		Leather 3 2985		Leather 4 3090		Leather 5 3195		Leather 6 3300		Leather 8 4245		COL 1971		S Nail 75		M Nail 90	

Fabric SKU: **8856-05**

Leather SKU: **N/A**

Standard Pillows: N/A Finish Req: N

Standard Cushions: High Resiliency 40 Standard Finish: Tobacco

COM: 2 yards COL: N/A

Parsons Side Chair

Width: 18.5 Depth: 24 Height: 41.25

AH: 0 SH: 19.5 SD: 17 IW: 18.5

Weight: 16 lbs Cube: 10.59

D	E	F	G	H	J	K COM	L	M	N	O	P	Q	R	S	T	U	(# above U) *	S Nail	M Nail
975	984	993	1002	1011	1020	1029	1038	1047	1056	1065	1074	1083	1092	1101	1110	1119	9 (Riser) + 1119 (U)	45	60
Leather 1 N/A		Leather 2 N/A		Leather 3 N/A		Leather 4 N/A		Leather 5 N/A		Leather 6 N/A		Leather 8 N/A		COL N/A		S Nail N/A		M Nail N/A	

Upholstery

**Pillows are not available on leather SKUs*

Fabric SKU: **8857-05**

Leather SKU: **N/A**

Standard Pillows: N/A Finish Req: N

Standard Cushions: High Resiliency 40 Standard Finish: Tobacco

COM: 2.25 yards COL: N/A

Lasso Side Chair

Width: 18.5 Depth: 24 Height: 41.25

AH: 0 SH: 19.5 SD: 17 IW: 18.5

Weight: 16 lbs Cube: 15.74

D	E	F	G	H	J	K COM	L	M	N	O	P	Q	R	S	T	U	(# above U) *	S Nail	M Nail
975	984	993	1002	1011	1020	1029	1038	1047	1056	1065	1074	1083	1092	1101	1110	1119	9 (Riser) + 1119 (U)	45	60
Leather 1 N/A		Leather 2 N/A		Leather 3 N/A		Leather 4 N/A		Leather 5 N/A		Leather 6 N/A		Leather 8 N/A		COL N/A		S Nail N/A		M Nail N/A	

Fabric SKU: **8858-04**

Leather SKU: **L-8858-04**

Standard Pillows: N/A Finish Req: Y

Standard Cushions: High Resiliency 40 Standard Finish:

COM: 2.75 yards COL: 51 square feet

Sidda Arm Chair

Width: 22 Depth: 25 Height: 33.5

AH: 25.25 SH: 18.5 SD: 18.25 IW: 18

Weight: 25 lbs Cube: 10.66

D	E	F	G	H	J	K COM	L	M	N	O	P	Q	R	S	T	U	(# above U) *	S Nail	M Nail
1200	1209	1218	1227	1236	1245	1254	1263	1272	1281	1290	1299	1308	1317	1326	1335	1344	9 (Riser) + 1344 (U)	45	60
Leather 1 1845		Leather 2 1920		Leather 3 1995		Leather 4 2070		Leather 5 2145		Leather 6 2220		Leather 8 2925		COL 1272		S Nail 45		M Nail 60	

Fabric SKU: **8858-A2**

Leather SKU: **L-8858-A2**

Standard Pillows: N/A Finish Req: Y

Standard Cushions: High Resiliency 40 Standard Finish:

COM: 2.75 yards COL: 51 square feet

Standard with 2 front casters

Sidda Arm Chair

Two Casters

Width: 22 Depth: 25 Height: 33.5

AH: 25.25 SH: 18.5 SD: 18.25 IW: 18

Weight: 25 lbs Cube: 15.74

D	E	F	G	H	J	K COM	L	M	N	O	P	Q	R	S	T	U	(# above U) *	S Nail	M Nail
1236	1245	1254	1263	1272	1281	1290	1299	1308	1317	1326	1335	1344	1353	1362	1371	1380	9 (Riser) + 1380 (U)	45	60
Leather 1 1875		Leather 2 1950		Leather 3 2025		Leather 4 2100		Leather 5 2175		Leather 6 2250		Leather 8 2955		COL 1308		S Nail 45		M Nail 60	

Fabric SKU: **8858-A4**

Leather SKU: **L-8858-A4**

Standard Pillows: N/A Finish Req: Y

Standard Cushions: High Resiliency 40 Standard Finish:

COM: 2.75 yards COL: 51 square feet

Standard with 4 casters

Sidda Arm Chair

Four Casters

Width: 22 Depth: 25 Height: 33.5

AH: 25.25 SH: 18.5 SD: 18.25 IW: 18

Weight: 25 lbs Cube: 10.66

D	E	F	G	H	J	K COM	L	M	N	O	P	Q	R	S	T	U	(# above U) *	S Nail	M Nail
1272	1281	1290	1299	1308	1317	1326	1335	1344	1353	1362	1371	1380	1389	1398	1407	1416	9 (Riser) + 1416 (U)	45	60
Leather 1 1920		Leather 2 1995		Leather 3 2070		Leather 4 2145		Leather 5 2220		Leather 6 2295		Leather 8 3000		COL 1344		S Nail 45		M Nail 60	

Fabric SKU: **8859-04**

Leather SKU: **L-8859-04**

Standard Pillows: N/A Finish Req: Y

Standard Cushions: High Resiliency 40 Standard Finish:

COM: 2 yards COL: 40 square feet

Bentley Arm Chair

Width: 23.5 Depth: 27.5 Height: 38.25

AH: 25 SH: 19.5 SD: 20 IW: 20

Weight: 25 lbs Cube: 15.74

D	E	F	G	H	J	K COM	L	M	N	O	P	Q	R	S	T	U	(# above U) *	S Nail	M Nail
1290	1296	1302	1308	1314	1320	1326	1332	1338	1344	1350	1356	1362	1368	1374	1380	1386	6 (Riser) + 1386 (U)	N/A	N/A
Leather 1 1770		Leather 2 1830		Leather 3 1890		Leather 4 1950		Leather 5 2010		Leather 6 2070		Leather 8 2625		COL 1338		S Nail N/A		M Nail N/A	

Fabric SKU: **8859-A2**

Leather SKU: **L-8859-A2**

Standard Pillows: N/A Finish Req: Y

Standard Cushions: High Resiliency 40 Standard Finish:

COM: 2 yards COL: 40 square feet

Bentley Arm Chair

Width: 23.5 Depth: 27.5 Height: 38.25

AH: 25 SH: 19.5 SD: 20 IW: 20

Weight: 25 lbs Cube: 14.3

D	E	F	G	H	J	K COM	L	M	N	O	P	Q	R	S	T	U	(# above U) *	S Nail	M Nail
1326	1332	1338	1344	1350	1356	1362	1368	1374	1380	1386	1392	1398	1404	1410	1416	1422	6 (Riser) + 1422 (U)	N/A	N/A
Leather 1 1815		Leather 2 1875		Leather 3 1935		Leather 4 1995		Leather 5 2055		Leather 6 2115		Leather 8 2670		COL 1374		S Nail N/A		M Nail N/A	

Upholstery

**Pillows are not available on leather SKUs*

Fabric SKU: **8859-A4**

Leather SKU: **L-8859-A4**

Standard Pillows: N/A Finish Req: Y

Standard Cushions: High Resiliency 40 Standard Finish:

COM: 2 yards COL: 40 square feet

Bentley Arm Chair

Width: 23.5 Depth: 27.5 Height: 38.25

AH: 25 SH: 19.5 SD: 20 IW: 20

Weight: 25 lbs Cube: 14.3

D	E	F	G	H	J	K COM	L	M	N	O	P	Q	R	S	T	U	(# above U) *	S Nail	M Nail
1362	1368	1374	1380	1386	1392	1398	1404	1410	1416	1422	1428	1434	1440	1446	1452	1458	6 (Riser) + 1458 (U)	N/A	N/A
Leather 1 1845		Leather 2 1905		Leather 3 1965		Leather 4 2025		Leather 5 2085		Leather 6 2145		Leather 8 2700		COL 1410		S Nail N/A		M Nail N/A	

Fabric SKU: **8860-04**

Leather SKU: **L-8860-04**

Standard Pillows: N/A Finish Req: Y

Standard Cushions: High Resiliency 40 Standard Finish:

COM: 2.5 yards COL: 51 square feet

Sasha Arm Chair

Width: 23 Depth: 27.5 Height: 39.5

AH: 25 SH: 19 SD: 20 IW: 20

Weight: 25 lbs Cube: 21.65

D	E	F	G	H	J	K COM	L	M	N	O	P	Q	R	S	T	U	(# above U) *	S Nail	M Nail
1170	1179	1188	1197	1206	1215	1224	1233	1242	1251	1260	1269	1278	1287	1296	1305	1314	9 (Riser) + 1314 (U)	45	N/A
Leather 1 1800		Leather 2 1875		Leather 3 1950		Leather 4 2025		Leather 5 2100		Leather 6 2175		Leather 8 2880		COL 1242		S Nail 45		M Nail N/A	

Fabric SKU: **8860-05**

Leather SKU: **L-8860-05**

Standard Pillows: N/A Finish Req: Y

Standard Cushions: High Resiliency 40 Standard Finish:

COM: 2.5 yards COL: 51 square feet

Sasha Side Chair

Width: 21.5 Depth: 27.5 Height: 39

AH: 0 SH: 19 SD: 20 IW: 21.5

Weight: 24 lbs Cube: 15.74

D	E	F	G	H	J	K COM	L	M	N	O	P	Q	R	S	T	U	(# above U) *	S Nail	M Nail
1140	1149	1158	1167	1176	1185	1194	1203	1212	1221	1230	1239	1248	1257	1266	1275	1284	9 (Riser) + 1284 (U)	45	N/A
Leather 1 1770		Leather 2 1845		Leather 3 1920		Leather 4 1995		Leather 5 2070		Leather 6 2145		Leather 8 2850		COL 1212		S Nail 45		M Nail N/A	

Fabric SKU: **8860-A4**

Leather SKU: **L-8860-A4**

Standard Pillows: N/A Finish Req: Y

Standard Cushions: High Resiliency 40 Standard Finish:

COM: 2.5 yards COL: 51 square feet

Standard with 4 casters

Sasha Arm Chair

Four Casters

Width: 23 Depth: 27.5 Height: 39.5

AH: 25 SH: 19 SD: 20 IW: 20

Weight: 25 lbs Cube: 14.45

D	E	F	G	H	J	K COM	L	M	N	O	P	Q	R	S	T	U	(# above U) *	S Nail	M Nail
1242	1251	1260	1269	1278	1287	1296	1305	1314	1323	1332	1341	1350	1359	1368	1377	1386	9 (Riser) + 1386 (U)	45	N/A
Leather 1 1875		Leather 2 1950		Leather 3 2025		Leather 4 2100		Leather 5 2175		Leather 6 2250		Leather 8 2955		COL 1314		S Nail 45		M Nail N/A	

Fabric SKU: **8862-04**

Leather SKU: **L-8862-04**

Standard Pillows: N/A Finish Req: Y

Standard Cushions: High Resiliency 40 Standard Finish:

COM: 2 yards COL: 34 square feet

Portia Arm Chair

Width: 24.5 Depth: 25 Height: 38

AH: 26 SH: 19 SD: 18.5 IW: 21

Weight: 25 lbs Cube: 13.46

D	E	F	G	H	J	K COM	L	M	N	O	P	Q	R	S	T	U	(# above U) *	S Nail	M Nail
1125	1131	1137	1143	1149	1155	1161	1167	1173	1179	1185	1191	1197	1203	1209	1215	1221	6 (Riser) + 1221 (U)	45	N/A
Leather 1 1545		Leather 2 1605		Leather 3 1665		Leather 4 1725		Leather 5 1785		Leather 6 1845		Leather 8 2310		COL 1173		S Nail 45		M Nail N/A	

Fabric SKU: **8862-A4**

Leather SKU: **L-8862-A4**

Standard Pillows: N/A Finish Req: Y

Standard Cushions: High Resiliency 40 Standard Finish:

COM: 2 yards COL: 34 square feet

Standard with 4 casters

Portia Arm Chair

Four Casters

Width: 24.5 Depth: 25 Height: 38

AH: 26 SH: 19 SD: 18.5 IW: 21

Weight: 25 lbs Cube: 13.46

D	E	F	G	H	J	K COM	L	M	N	O	P	Q	R	S	T	U	(# above U) *	S Nail	M Nail
1197	1203	1209	1215	1221	1227	1233	1239	1245	1251	1257	1263	1269	1275	1281	1287	1293	6 (Riser) + 1293 (U)	45	N/A
Leather 1 1620		Leather 2 1680		Leather 3 1740		Leather 4 1800		Leather 5 1860		Leather 6 1920		Leather 8 2385		COL 1245		S Nail 45		M Nail N/A	

Upholstery

**Pillows are not available on leather SKUs*

Fabric SKU: **8863-04**

Leather SKU: **L-8863-04**

Standard Pillows: N/A **Finish Req:** Y

Standard Cushions: High Resiliency 40 **Standard Finish:**

COM: 2 yards **COL:** 40 square feet

Toulouse Arm Chair

Width: 23.5 **Depth:** 26 **Height:** 37

AH: 25 **SH:** 19.5 **SD:** 20 **IW:** 21

Weight: 23 lbs **Cube:** 15.74

D	E	F	G	H	J	K COM	L	M	N	O	P	Q	R	S	T	U	(# above U) *	S Nail	M Nail
1245	1251	1257	1263	1269	1275	1281	1287	1293	1299	1305	1311	1317	1323	1329	1335	1341	6 (Riser) + 1341 (U)	N/A	N/A
Leather 1 1725		Leather 2 1785		Leather 3 1845		Leather 4 1905		Leather 5 1965		Leather 6 2025		Leather 8 2580		COL 1293		S Nail N/A		M Nail N/A	

Fabric SKU: **8863-A2**

Leather SKU: **L-8863-A2**

Standard Pillows: N/A **Finish Req:** Y

Standard Cushions: High Resiliency 40 **Standard Finish:**

COM: 2 yards **COL:** 40 square feet

Standard with two front casters.

Toulouse Arm Chair

Two Casters

Width: 23.5 **Depth:** 26 **Height:** 37

AH: 25 **SH:** 19.5 **SD:** 20 **IW:** 21

Weight: 23 lbs **Cube:** 13.08

D	E	F	G	H	J	K COM	L	M	N	O	P	Q	R	S	T	U	(# above U) *	S Nail	M Nail
1281	1287	1293	1299	1305	1311	1317	1323	1329	1335	1341	1347	1353	1359	1365	1371	1377	6 (Riser) + 1377 (U)	N/A	N/A
Leather 1 1755		Leather 2 1815		Leather 3 1875		Leather 4 1935		Leather 5 1995		Leather 6 2055		Leather 8 2610		COL 1329		S Nail N/A		M Nail N/A	

Fabric SKU: **8863-A4**

Leather SKU: **L-8863-A4**

Standard Pillows: N/A **Finish Req:** Y

Standard Cushions: High Resiliency 40 **Standard Finish:**

COM: 2 yards **COL:** 40 square feet

Standard with four casters.

Toulouse Arm Chair

Four Casters

Width: 23.5 **Depth:** 26 **Height:** 37

AH: 25 **SH:** 19.5 **SD:** 20 **IW:** 21

Weight: 23 lbs **Cube:** 13.08

D	E	F	G	H	J	K COM	L	M	N	O	P	Q	R	S	T	U	(# above U) *	S Nail	M Nail
1317	1323	1329	1335	1341	1347	1353	1359	1365	1371	1377	1383	1389	1395	1401	1407	1413	6 (Riser) + 1413 (U)	N/A	N/A
Leather 1 1800		Leather 2 1860		Leather 3 1920		Leather 4 1980		Leather 5 2040		Leather 6 2100		Leather 8 2655		COL 1365		S Nail 105		M Nail N/A	

Fabric SKU: **8864-04**

Leather SKU: **L-8864-04**

Standard Pillows: N/A **Finish Req:** Y

Standard Cushions: High Resiliency 40 **Standard Finish:**

COM: 3.75 yards **COL:** 74 square feet

Our Clean Out seat design provides the caregiver access to easily and swiftly remove debris on a variety of Fairfield styles. We recognize that sanitation and cleaning are critical to the lifestyle of the community.

Width: 22.5 **Depth:** 25.5 **Height:** 36.5

AH: 25.75 **SH:** 19.5 **SD:** 19.5 **IW:** 18

Weight: 30 lbs **Cube:** 15.74

D	E	F	G	H	J	K COM	L	M	N	O	P	Q	R	S	T	U	(# above U) *	S Nail	M Nail
1815	1830	1845	1860	1875	1890	1905	1920	1935	1950	1965	1980	1995	2010	2025	2040	2055	15 (Riser) + 2055 (U)	75	90
Leather 1 2655		Leather 2 2775		Leather 3 2895		Leather 4 3015		Leather 5 3135		Leather 6 3255		Leather 8 4275		COL 1935		S Nail 75		M Nail 90	

Fabric SKU: **8864-04-M**

Leather SKU: **L-8864-04-M**

Standard Pillows: N/A **Finish Req:** N

Standard Cushions: High Resiliency 40 **Standard Finish:** Mica

COM: 3.75 yards **COL:** 74 square feet

Our Clean Out seat design provides the caregiver access to easily and swiftly remove debris on a variety of Fairfield styles. We recognize that sanitation and cleaning are critical to the lifestyle of the community.

Cleo Grande Arm Chair

with Base in Mica Finish

Width: 24.5 **Depth:** 24.75 **Height:** 31.75

AH: 26 **SH:** 19.5 **SD:** 19.5 **IW:** 20

Weight: 30 lbs **Cube:** 11.14

D	E	F	G	H	J	K COM	L	M	N	O	P	Q	R	S	T	U	(# above U) *	S Nail	M Nail
1485	1500	1515	1530	1545	1560	1575	1590	1605	1620	1635	1650	1665	1680	1695	1710	1725	15 (Riser) + 1725 (U)	75	90
Leather 1 2385		Leather 2 2505		Leather 3 2625		Leather 4 2745		Leather 5 2865		Leather 6 2985		Leather 8 4005		COL 1605		S Nail 75		M Nail 90	

Fabric SKU: **8864-A2**

Leather SKU: **L-8864-A2**

Standard Pillows: N/A **Finish Req:** Y

Standard Cushions: High Resiliency 40 **Standard Finish:**

COM: 3.75 yards **COL:** 74 square feet

Our Clean Out seat design provides the caregiver access to easily and swiftly remove debris on a variety of Fairfield styles. We recognize that sanitation and cleaning are critical to the lifestyle of the community. Standard with 2 front casters

Cleo Grande Arm Chair

with two front casters

Width: 24.5 **Depth:** 24.75 **Height:** 31.75

AH: 26 **SH:** 19.5 **SD:** 19.5 **IW:** 20

Weight: 30 lbs **Cube:** 11.14

D	E	F	G	H	J	K COM	L	M	N	O	P	Q	R	S	T	U	(# above U) *	S Nail	M Nail
1851	1866	1881	1896	1911	1926	1941	1956	1971	1986	2001	2016	2031	2046	2061	2076	2091	15 (Riser) + 2091 (U)	75	90
Leather 1 2685		Leather 2 2805		Leather 3 2925		Leather 4 3045		Leather 5 3165		Leather 6 3285		Leather 8 4305		COL 1971		S Nail 75		M Nail 90	

Upholstery

**Pillows are not available on leather SKUs*

Fabric SKU: **8864-A2-M**

Leather SKU: **L-8864-A2-M**

Cleo Grande Arm Chair

with two front casters with Base in Mica Finish

Width: 24.5 **Depth:** 24.75 **Height:** 31.75

AH: 26 **SH:** 19.5 **SD:** 19.5 **IW:** 20

Weight: 30 lbs **Cube:** 11.14

D	E	F	G	H	J	K COM	L	M	N	O	P	Q	R	S	T	U	(# above U) *	S Nail	M Nail
1521	1536	1551	1566	1581	1596	1611	1626	1641	1656	1671	1686	1701	1716	1731	1746	1761	15 (Riser) + 1761 (U)	75	90
Leather 1 2415		Leather 2 2535		Leather 3 2655		Leather 4 2775		Leather 5 2895		Leather 6 3015		Leather 8 4035		COL 1641		S Nail 75		M Nail 90	

Standard Pillows: N/A **Finish Req:** N

Standard Cushions: High Resiliency 40 **Standard Finish:** Mica

COM: 3.75 yards **COL:** 74 square feet

Our Clean Out seat design provides the caregiver access to easily and swiftly remove debris on a variety of Fairfield styles. We recognize that sanitation and cleaning are critical to the lifestyle of the community. Standard with 2 front casters

Fabric SKU: **8864-A4**

Leather SKU: **L-8864-A4**

Cleo Grande Arm Chair

with four casters

Width: 24.5 **Depth:** 24.75 **Height:** 31.75

AH: 26 **SH:** 19.5 **SD:** 19.5 **IW:** 20

Weight: 30 lbs **Cube:** 11.14

D	E	F	G	H	J	K COM	L	M	N	O	P	Q	R	S	T	U	(# above U) *	S Nail	M Nail
1887	1902	1917	1932	1947	1962	1977	1992	2007	2022	2037	2052	2067	2082	2097	2112	2127	15 (Riser) + 2127 (U)	75	90
Leather 1 2730		Leather 2 2850		Leather 3 2970		Leather 4 3090		Leather 5 3210		Leather 6 3330		Leather 8 4350		COL 2007		S Nail 75		M Nail 90	

Standard Pillows: N/A **Finish Req:** Y

Standard Cushions: High Resiliency 40 **Standard Finish:**

COM: 3.75 yards **COL:** 74 square feet

Our Clean Out seat design provides the caregiver access to easily and swiftly remove debris on a variety of Fairfield styles. We recognize that sanitation and cleaning are critical to the lifestyle of the community. Standard with casters on all legs

Fabric SKU: **8864-A4-M**

Leather SKU: **L-8864-A4-M**

Cleo Grande Arm Chair

with four casters with Base in Mica Finish

Width: 24.5 **Depth:** 24.75 **Height:** 31.75

AH: 26 **SH:** 19.5 **SD:** 19.5 **IW:** 20

Weight: 30 lbs **Cube:** 11.14

D	E	F	G	H	J	K COM	L	M	N	O	P	Q	R	S	T	U	(# above U) *	S Nail	M Nail
1557	1572	1587	1602	1617	1632	1647	1662	1677	1692	1707	1722	1737	1752	1767	1782	1797	15 (Riser) + 1797 (U)	75	90
Leather 1 2460		Leather 2 2580		Leather 3 2700		Leather 4 2820		Leather 5 2940		Leather 6 3060		Leather 8 4080		COL 1677		S Nail 75		M Nail 90	

Standard Pillows: N/A **Finish Req:** N

Standard Cushions: High Resiliency 40 **Standard Finish:** Mica

COM: 3.75 yards **COL:** 74 square feet

Our Clean Out seat design provides the caregiver access to easily and swiftly remove debris on a variety of Fairfield styles. We recognize that sanitation and cleaning are critical to the lifestyle of the community. Standard with casters on all legs

Fabric SKU: **8865-04**

Leather SKU: **L-8865-04**

Josie Grande Arm Chair

Width: 24.5 **Depth:** 25.5 **Height:** 36.5

AH: 25.75 **SH:** 19.5 **SD:** 19.5 **IW:** 21.5

Weight: 30 lbs **Cube:** 13.19

D	E	F	G	H	J	K COM	L	M	N	O	P	Q	R	S	T	U	(# above U) *	S Nail	M Nail
1815	1830	1845	1860	1875	1890	1905	1920	1935	1950	1965	1980	1995	2010	2025	2040	2055	15 (Riser) + 2055 (U)	75	90
Leather 1 2655		Leather 2 2775		Leather 3 2895		Leather 4 3015		Leather 5 3135		Leather 6 3255		Leather 8 4275		COL 1935		S Nail 75		M Nail 90	

Standard Pillows: N/A **Finish Req:** Y

Standard Cushions: High Resiliency 40 **Standard Finish:**

COM: 3.75 yards **COL:** 62 square feet

Our Clean Out seat design provides the caregiver access to easily and swiftly remove debris on a variety of Fairfield styles. We recognize that sanitation and cleaning are critical to the lifestyle of the community.

Fabric SKU: **8865-04-M**

Leather SKU: **L-8865-04-M**

Josie Grande Arm Chair

with Base in Mica Finish

Width: 24.5 **Depth:** 25.5 **Height:** 36.5

AH: 25.75 **SH:** 19.5 **SD:** 19.5 **IW:** 21.5

Weight: 30 lbs **Cube:** 13.19

D	E	F	G	H	J	K COM	L	M	N	O	P	Q	R	S	T	U	(# above U) *	S Nail	M Nail
1485	1500	1515	1530	1545	1560	1575	1590	1605	1620	1635	1650	1665	1680	1695	1710	1725	15 (Riser) + 1725 (U)	75	90
Leather 1 2385		Leather 2 2505		Leather 3 2625		Leather 4 2745		Leather 5 2865		Leather 6 2985		Leather 8 4005		COL 1605		S Nail 75		M Nail 90	

Standard Pillows: N/A **Finish Req:** N

Standard Cushions: High Resiliency 40 **Standard Finish:** Mica

COM: 3.75 yards **COL:** 62 square feet

Our Clean Out seat design provides the caregiver access to easily and swiftly remove debris on a variety of Fairfield styles. We recognize that sanitation and cleaning are critical to the lifestyle of the community.

Fabric SKU: **8865-A2**

Leather SKU: **L-8865-A2**

Josie Grande Arm Chair

with two front casters

Width: 24.5 **Depth:** 25.5 **Height:** 36.5

AH: 25.75 **SH:** 19.5 **SD:** 19.5 **IW:** 21.5

Weight: 30 lbs **Cube:** 13.19

D	E	F	G	H	J	K COM	L	M	N	O	P	Q	R	S	T	U	(# above U) *	S Nail	M Nail
1851	1866	1881	1896	1911	1926	1941	1956	1971	1986	2001	2016	2031	2046	2061	2076	2091	15 (Riser) + 2091 (U)	75	90
Leather 1 2685		Leather 2 2805		Leather 3 2925		Leather 4 3045		Leather 5 3165		Leather 6 3285		Leather 8 4305		COL 1971		S Nail 75		M Nail 90	

Standard Pillows: N/A **Finish Req:** Y

Standard Cushions: High Resiliency 40 **Standard Finish:**

COM: 3.75 yards **COL:** 632 square feet

Our Clean Out seat design provides the caregiver access to easily and swiftly remove debris on a variety of Fairfield styles. We recognize that sanitation and cleaning are critical to the lifestyle of the community. Standard with 2 front casters

Upholstery

**Pillows are not available on leather SKUs*

Fabric SKU: **8865-A2-M**

Leather SKU: **L-8865-A2-M**

Josie Grande Arm Chair

with two front casters, with Base in Mica Finish

Width: 24.5 **Depth:** 25.5 **Height:** 36.5

AH: 25.75 **SH:** 19.5 **SD:** 19.5 **IW:** 21.5

Weight: 30 lbs **Cube:** 13.19

Standard Pillows: N/A **Finish Req:** N

Standard Cushions: High Resiliency 40 **Standard Finish:** Mica

COM: 3.75 yards **COL:** 62 square feet

Our Clean Out seat design provides the caregiver access to easily and swiftly remove debris on a variety of Fairfield styles. We recognize that sanitation and cleaning are critical to the lifestyle of the community. Standard with 2 front casters

D	E	F	G	H	J	K COM	L	M	N	O	P	Q	R	S	T	U	(# above U) *	S Nail	M Nail
1521	1536	1551	1566	1581	1596	1611	1626	1641	1656	1671	1686	1701	1716	1731	1746	1761	15 (Riser) + 1761 (U)	75	90
Leather 1 2415		Leather 2 2535		Leather 3 2655		Leather 4 2775		Leather 5 2895		Leather 6 3015		Leather 8 4035		COL 1641		S Nail 75		M Nail 90	

Fabric SKU: **8865-A4**

Leather SKU: **L-8865-A4**

Josie Grande Arm Chair

with four casters

Width: 24.5 **Depth:** 25.5 **Height:** 36.5

AH: 25.75 **SH:** 19.5 **SD:** 19.5 **IW:** 21.5

Weight: 30 lbs **Cube:** 13.19

Standard Pillows: N/A **Finish Req:** Y

Standard Cushions: High Resiliency 40 **Standard Finish:**

COM: 3.75 yards **COL:** 62 square feet

Our Clean Out seat design provides the caregiver access to easily and swiftly remove debris on a variety of Fairfield styles. We recognize that sanitation and cleaning are critical to the lifestyle of the community. Standard with casters on all legs

D	E	F	G	H	J	K COM	L	M	N	O	P	Q	R	S	T	U	(# above U) *	S Nail	M Nail
1887	1902	1917	1932	1947	1962	1977	1992	2007	2022	2037	2052	2067	2082	2097	2112	2127	15 (Riser) + 2127 (U)	75	90
Leather 1 2730		Leather 2 2850		Leather 3 2970		Leather 4 3090		Leather 5 3210		Leather 6 3330		Leather 8 4350		COL 2007		S Nail 75		M Nail 90	

Fabric SKU: **8865-A4-M**

Leather SKU: **L-8865-A4-M**

Josie Grande Arm Chair

with four casters, with Base in Mica Finish

Width: 24.5 **Depth:** 25.5 **Height:** 36.5

AH: 25.75 **SH:** 19.5 **SD:** 19.5 **IW:** 21.5

Weight: 30 lbs **Cube:** 13.19

Standard Pillows: N/A **Finish Req:** N

Standard Cushions: High Resiliency 40 **Standard Finish:** Mica

COM: 3.75 yards **COL:** 62 square feet

Our Clean Out seat design provides the caregiver access to easily and swiftly remove debris on a variety of Fairfield styles. We recognize that sanitation and cleaning are critical to the lifestyle of the community. Standard with casters on all legs

D	E	F	G	H	J	K COM	L	M	N	O	P	Q	R	S	T	U	(# above U) *	S Nail	M Nail
1557	1572	1587	1602	1617	1632	1647	1662	1677	1692	1707	1722	1737	1752	1767	1782	1797	15 (Riser) + 1797 (U)	75	90
Leather 1 2460		Leather 2 2580		Leather 3 2700		Leather 4 2820		Leather 5 2940		Leather 6 3060		Leather 8 4080		COL 1677		S Nail 75		M Nail 90	

Fabric SKU: **8866-04**

Leather SKU: **L-8866-04**

Garth Arm Chair

Width: 24.5 **Depth:** 24.75 **Height:** 31.75

AH: 26 **SH:** 19.5 **SD:** 21.5 **IW:** 20

Weight: 32 lbs **Cube:** 11.14

Standard Pillows: N/A **Finish Req:** Y

Standard Cushions: High Resiliency 40 **Standard Finish:**

COM: 2 yards **COL:** 40 square feet

D	E	F	G	H	J	K COM	L	M	N	O	P	Q	R	S	T	U	(# above U) *	S Nail	M Nail
1095	1101	1107	1113	1119	1125	1131	1137	1143	1149	1155	1161	1167	1173	1179	1185	1191	6 (Riser) + 1191 (U)	N/A	N/A
Leather 1 1575		Leather 2 1635		Leather 3 1695		Leather 4 1755		Leather 5 1815		Leather 6 1875		Leather 8 2430		COL 1143		S Nail N/A		M Nail N/A	

Fabric SKU: **8866-05**

Leather SKU: **L-8866-05**

Garth Side Chair

Width: 20 **Depth:** 24.5 **Height:** 34.75

AH: 0 **SH:** 20.5 **SD:** 20 **IW:** 20

Weight: 17 lbs **Cube:** 9.85

Standard Pillows: N/A **Finish Req:** Y

Standard Cushions: High Resiliency 40 **Standard Finish:**

COM: 2 yards **COL:** 40 square feet

D	E	F	G	H	J	K COM	L	M	N	O	P	Q	R	S	T	U	(# above U) *	S Nail	M Nail
1065	1071	1077	1083	1089	1095	1101	1107	1113	1119	1125	1131	1137	1143	1149	1155	1161	6 (Riser) + 1161 (U)	N/A	N/A
Leather 1 1545		Leather 2 1605		Leather 3 1665		Leather 4 1725		Leather 5 1785		Leather 6 1845		Leather 8 2400		COL 1113		S Nail N/A		M Nail N/A	

Fabric SKU: **8868-04**

Leather SKU: **L-8868-04**

Sidda Arm Chair

Width: 22 **Depth:** 25 **Height:** 33.5

AH: 25 **SH:** 18.5 **SD:** 18 **IW:** 18

Weight: 25 lbs **Cube:** 10.66

Standard Pillows: N/A **Finish Req:** Y

Standard Cushions: High Resiliency 40 **Standard Finish:**

COM: 2.75 yards **COL:** 51 square feet

D	E	F	G	H	J	K COM	L	M	N	O	P	Q	R	S	T	U	(# above U) *	S Nail	M Nail
1125	1134	1143	1152	1161	1170	1179	1188	1197	1206	1215	1224	1233	1242	1251	1260	1269	9 (Riser) + 1269 (U)	45	60
Leather 1 1785		Leather 2 1860		Leather 3 1935		Leather 4 2010		Leather 5 2085		Leather 6 2160		Leather 8 2865		COL 1197		S Nail 45		M Nail 60	

Upholstery

**Pillows are not available on leather SKUs*

Fabric SKU: **8868-A2**

Leather SKU: **L-8868-A2**

Standard Pillows: N/A Finish Req: Y

Standard Cushions: High Resiliency 40 Standard Finish:

COM: 2.75 yards COL: 51 square feet

Standard with 2 front casters

Sidda Arm Chair

Two Casters

Width: 22 Depth: 25 Height: 33.5

AH: 25 SH: 18.5 SD: 18 IW: 18

Weight: 25 lbs Cube: 10.66

D	E	F	G	H	J	K COM	L	M	N	O	P	Q	R	S	T	U	(# above U) *	S Nail	M Nail
1161	1170	1179	1188	1197	1206	1215	1224	1233	1242	1251	1260	1269	1278	1287	1296	1305	9 (Riser) + 1305 (U)	45	60
Leather 1 1815		Leather 2 1890		Leather 3 1965		Leather 4 2040		Leather 5 2115		Leather 6 2190		Leather 8 2895		COL 1233		S Nail 45		M Nail 60	

Fabric SKU: **8868-A4**

Leather SKU: **L-8868-A4**

Standard Pillows: N/A Finish Req: Y

Standard Cushions: High Resiliency 40 Standard Finish:

COM: 2.75 yards COL: 51 square feet

Standard with 4 casters

Sidda Arm Chair

Four Casters

Width: 22 Depth: 25 Height: 33.5

AH: 25 SH: 18.5 SD: 18 IW: 18

Weight: 25 lbs Cube: 10.66

D	E	F	G	H	J	K COM	L	M	N	O	P	Q	R	S	T	U	(# above U) *	S Nail	M Nail
1197	1206	1215	1224	1233	1242	1251	1260	1269	1278	1287	1296	1305	1314	1323	1332	1341	9 (Riser) + 1341 (U)	45	60
Leather 1 1860		Leather 2 1935		Leather 3 2010		Leather 4 2085		Leather 5 2160		Leather 6 2235		Leather 8 2940		COL 1269		S Nail 45		M Nail 60	

Fabric SKU: **8869-04**

Leather SKU: **L-8869-04**

Standard Pillows: N/A Finish Req: Y

Standard Cushions: High Resiliency 40 Standard Finish:

COM: 3.5 yards COL: 57.6 square feet

Casey Arm Chair

Width: 25 Depth: 25.5 Height: 38

AH: 26 SH: 20 SD: 17.5 IW: 22

Weight: 30 lbs Cube: 15.74

D	E	F	G	H	J	K COM	L	M	N	O	P	Q	R	S	T	U	(# above U) *	S Nail	M Nail
1275	1284	1293	1302	1311	1320	1329	1338	1347	1356	1365	1374	1383	1392	1401	1410	1419	9 (Riser) + 1419 (U)	45	60
Leather 1 2010		Leather 2 2100		Leather 3 2190		Leather 4 2280		Leather 5 2370		Leather 6 2460		Leather 8 3255		COL 1347		S Nail 45		M Nail 60	

Fabric SKU: **8899-A4**

Leather SKU: **N/A**

Standard Pillows: (1) 10 x 16 Kidney Finish Req: N

Standard Cushions: Endurance Standard Finish: Traditional

COM: 5.5 yards COL: N/A

Coleman Arm Chair

Width: 24.5 Depth: 29.5 Height: 38.5

AH: 24.25 SH: 19.5 SD: 18 IW: 19

Weight: 34 lbs Cube: 21.65

D	E	F	G	H	J	K COM	L	M	N	O	P	Q	R	S	T	U	(# above U) *	S Nail	M Nail
2025	2043	2061	2079	2097	2115	2133	2151	2169	2187	2205	2223	2241	2259	2277	2295	2313	18 (Riser) + 2313 (U)	N/A	N/A
Leather 1 N/A		Leather 2 N/A		Leather 3 N/A		Leather 4 N/A		Leather 5 N/A		Leather 6 N/A		Leather 8 N/A		COL N/A		S Nail N/A		M Nail N/A	

Fabric SKU: **400C-MR**

Leather SKU: **L-400C-MR**

Standard Pillows: N/A Finish Req: N

Standard Cushions: Repose Standard Finish:

COM: 8.75 yards COL: 152 square feet

Beth Page Manual Push Back Recliner

Width: 31 Depth: 37.5 Height: 43

AH: 24.5 SH: 21.5 SD: 20 IW: 22 Recl D: 66 TV Recl: 57 Wall Cir: 16

Weight: 122 lbs Cube: 43.25

D	E	F	G	H	J	K COM	L	M	N	O	P	Q	R	S	T	U	(# above U) *	S Nail	M Nail
3600	3624	3648	3672	3696	3720	3744	3768	3792	3816	3840	3864	3888	3912	3936	3960	3984	24 (Riser) + 3984 (U)	60	N/A
Leather 1 5325		Leather 2 5550		Leather 3 5775		Leather 4 6000		Leather 5 6225		Leather 6 6450		Leather 8 8475		COL 3792		S Nail 60		M Nail N/A	

Fabric SKU: **401C-MR**

Leather SKU: **L-401C-MR**

Standard Pillows: N/A Finish Req: Y

Standard Cushions: Repose Standard Finish:

COM: 8 yards COL: 141 square feet

Pinehurst Manual Push Back Recliner

Width: 31 Depth: 37.5 Height: 43

AH: 24.5 SH: 21.5 SD: 20 IW: 22 Recl D: 66 TV Recl: 57 Wall Cir: 16

Weight: 122 lbs Cube: 43.25

D	E	F	G	H	J	K COM	L	M	N	O	P	Q	R	S	T	U	(# above U) *	S Nail	M Nail
3600	3624	3648	3672	3696	3720	3744	3768	3792	3816	3840	3864	3888	3912	3936	3960	3984	24 (Riser) + 3984 (U)	N/A	N/A
Leather 1 5325		Leather 2 5535		Leather 3 5745		Leather 4 5955		Leather 5 6165		Leather 6 6375		Leather 8 8235		COL 3792		S Nail N/A		M Nail N/A	

Upholstery

**Pillows are not available on leather SKUs*

Fabric SKU: **402C-MR** Leather SKU: **L-402C-MR**
 RECLINATION
St. Andrews Manual Push Back Recliner

Standard Pillows: N/A **Finish Req:** Y
Standard Cushions: Repose **Standard Finish:**
COM: 9 yards **COL:** 158 square feet

Width: 31 **Depth:** 37.5 **Height:** 43
AH: 24.5 **SH:** 21.5 **SD:** 20 **IW:** 22 **Recl D:** 66 **TV Recl:** 57 **Wall Clr:** 16
Weight: 122 lbs **Cube:** 43.25

D	E	F	G	H	J	K COM	L	M	N	O	P	Q	R	S	T	U	(# above U) *	S Nail	M Nail
3600	3624	3648	3672	3696	3720	3744	3768	3792	3816	3840	3864	3888	3912	3936	3960	3984	24 (Riser) + 3984 (U)	60	N/A
Leather 1 5400		Leather 2 5640		Leather 3 5880		Leather 4 6120		Leather 5 6360		Leather 6 6600		Leather 8 8700		COL 3792		S Nail 60		M Nail N/A	

Fabric SKU: **403C-MR** Leather SKU: **L-403C-MR**
 RECLINATION
Spyglass Manual Push Back Recliner

Standard Pillows: N/A **Finish Req:** Y
Standard Cushions: Repose **Standard Finish:**
COM: 7.75 yards **COL:** 135 square feet

Width: 31 **Depth:** 37.5 **Height:** 43
AH: 24.5 **SH:** 21.5 **SD:** 20 **IW:** 22 **Recl D:** 66 **TV Recl:** 57 **Wall Clr:** 16
Weight: 122 lbs **Cube:** 28.92

D	E	F	G	H	J	K COM	L	M	N	O	P	Q	R	S	T	U	(# above U) *	S Nail	M Nail
3600	3624	3648	3672	3696	3720	3744	3768	3792	3816	3840	3864	3888	3912	3936	3960	3984	24 (Riser) + 3984 (U)	60	N/A
Leather 1 5400		Leather 2 5610		Leather 3 5820		Leather 4 6030		Leather 5 6240		Leather 6 6450		Leather 8 8310		COL 3792		S Nail 60		M Nail N/A	

Fabric SKU: **410C-MR** Leather SKU: **L-410C-MR**
 RECLINATION
Dale Manual Push Back Recliner

Standard Pillows: N/A **Finish Req:** Y
Standard Cushions: Repose **Standard Finish:**
COM: 10 yards **COL:** 169 square feet

Width: 33 **Depth:** 39.5 **Height:** 41
AH: 24 **SH:** 21.5 **SD:** 21 **IW:** 23 **Recl D:** 67.5 **TV Recl:** 56 **Wall Clr:** 17
Weight: 102 lbs **Cube:** 43.25

D	E	F	G	H	J	K COM	L	M	N	O	P	Q	R	S	T	U	(# above U) *	S Nail	M Nail
3600	3627	3654	3681	3708	3735	3762	3789	3816	3843	3870	3897	3924	3951	3978	4005	4032	27 (Riser) + 4032 (U)	120	135
Leather 1 5610		Leather 2 5865		Leather 3 6120		Leather 4 6375		Leather 5 6630		Leather 6 6885		Leather 8 9210		COL 3816		S Nail 120		M Nail 135	

Fabric SKU: **411C-MR** Leather SKU: **L-411C-MR**
 RECLINATION
Newberry Manual Push Back Recliner

Standard Pillows: N/A **Finish Req:** Y
Standard Cushions: Repose **Standard Finish:**
COM: 8.75 yards **COL:** 147 square feet

Width: 30 **Depth:** 40 **Height:** 42
AH: 26.5 **SH:** 22.5 **SD:** 20 **IW:** 21.5 **Recl D:** 68 **TV Recl:** 58 **Wall Clr:** 17.5
Weight: 119 lbs **Cube:** 43.25

D	E	F	G	H	J	K COM	L	M	N	O	P	Q	R	S	T	U	(# above U) *	S Nail	M Nail
3450	3474	3498	3522	3546	3570	3594	3618	3642	3666	3690	3714	3738	3762	3786	3810	3834	24 (Riser) + 3834 (U)	105	120
Leather 1 5250		Leather 2 5475		Leather 3 5700		Leather 4 5925		Leather 5 6150		Leather 6 6375		Leather 8 8400		COL 3642		S Nail 105		M Nail 120	

Fabric SKU: **450F-PL** Leather SKU: **L-450F-PL**
 RECLINATION
Drake Power Lift Recliner

Standard Pillows: N/A **Finish Req:** N
Standard Cushions: Repose **Standard Finish:**
COM: 8.25 yards **COL:** 164 square feet
 Features Dual Motors

Power Recline, Inside Power Switch
Width: 29 **Depth:** 36.5 **Height:** 40.75
AH: 24.5 **SH:** 21 **SD:** 20 **IW:** 20.5 **Recl D:** 66 **TV Recl:** 54.5 **Wall Clr:** 5
Weight: 129 lbs **Cube:** 24.96

D	E	F	G	H	J	K COM	L	M	N	O	P	Q	R	S	T	U	(# above U) *	S Nail	M Nail
5250	5274	5298	5322	5346	5370	5394	5418	5442	5466	5490	5514	5538	5562	5586	5610	5634	24 (Riser) + 5634 (U)	45	N/A
Leather 1 7125		Leather 2 7380		Leather 3 7635		Leather 4 7890		Leather 5 8145		Leather 6 8400		Leather 8 10665		COL 5442		S Nail 45		M Nail N/A	

Fabric SKU: **450G-MR** Leather SKU: **L-450G-MR**
 RECLINATION
Drake Manual Swivel Glider Recliner

Standard Pillows: N/A **Finish Req:** N
Standard Cushions: Repose **Standard Finish:**
COM: 8.25 yards **COL:** 147 square feet

Inside Release Handle
Width: 29 **Depth:** 36.5 **Height:** 40.75
AH: 24.5 **SH:** 21 **SD:** 20 **IW:** 20.5 **Recl D:** 66 **TV Recl:** 54.5 **Wall Clr:** 12
Weight: 129 lbs **Cube:** 24.96

D	E	F	G	H	J	K COM	L	M	N	O	P	Q	R	S	T	U	(# above U) *	S Nail	M Nail
3900	3924	3948	3972	3996	4020	4044	4068	4092	4116	4140	4164	4188	4212	4236	4260	4284	24 (Riser) + 4284 (U)	45	N/A
Leather 1 5700		Leather 2 5925		Leather 3 6150		Leather 4 6375		Leather 5 6600		Leather 6 6825		Leather 8 8850		COL 4092		S Nail 45		M Nail N/A	

Upholstery

**Pillows are not available on leather SKUs*

Fabric SKU: **450K-MR** Leather SKU: **L-450K-MR**

RECLINATION

Drake Manual Recline Glider

Inside Release Handle

Width: 29 **Depth:** 36.5 **Height:** 40.75

AH: 24.5 **SH:** 21 **SD:** 20 **IW:** 20.5 **Recl D:** 66 **TV Recl:** 54.5 **Wall Clr:** 12

Weight: 129 lbs **Cube:** 24.96

Standard Pillows: N/A **Finish Req:** N

Standard Cushions: Repose **Standard Finish:**

COM: 8.25 yards **COL:** 147 square feet

D	E	F	G	H	J	K COM	L	M	N	O	P	Q	R	S	T	U	(# above U) *	S Nail	M Nail
3900	3924	3948	3972	3996	4020	4044	4068	4092	4116	4140	4164	4188	4212	4236	4260	4284	24 (Riser) + 4284 (U)	45	N/A
Leather 1 5700		Leather 2 5925		Leather 3 6150		Leather 4 6375		Leather 5 6600		Leather 6 6825		Leather 8 8850		COL 4092		S Nail 45		M Nail N/A	

Fabric SKU: **450K-PR** Leather SKU: **L-450K-PR**

RECLINATION

Drake Power Glider Recliner

with Power Recline

Width: 29 **Depth:** 36.5 **Height:** 40.75

AH: 24.5 **SH:** 21 **SD:** 20 **IW:** 20.5 **Recl D:** 66 **TV Recl:** 54.5 **Wall Clr:** 12

Weight: 129 lbs **Cube:** 43.25

Standard Pillows: N/A **Finish Req:** N

Standard Cushions: Repose **Standard Finish:**

COM: 8.25 yards **COL:** 147 square feet

D	E	F	G	H	J	K COM	L	M	N	O	P	Q	R	S	T	U	(# above U) *	S Nail	M Nail
4350	4374	4398	4422	4446	4470	4494	4518	4542	4566	4590	4614	4638	4662	4686	4710	4734	24 (Riser) + 4734 (U)	45	N/A
Leather 1 6150		Leather 2 6375		Leather 3 6600		Leather 4 6825		Leather 5 7050		Leather 6 7275		Leather 8 9300		COL 4542		S Nail 45		M Nail N/A	

Fabric SKU: **450Z-MR** Leather SKU: **L-450Z-MR**

RECLINATION

Drake Manual Wall Hugger Recliner

Zero Wall Recline, Inside Release Handle

Width: 29 **Depth:** 36.5 **Height:** 40.75

AH: 24.5 **SH:** 21 **SD:** 20 **IW:** 20.5 **Recl D:** 66 **TV Recl:** 54.5 **Wall Clr:** 3.5

Weight: 129 lbs **Cube:** 24.96

Standard Pillows: N/A **Finish Req:** N

Standard Cushions: Repose **Standard Finish:**

COM: 8.25 yards **COL:** 147 square feet

D	E	F	G	H	J	K COM	L	M	N	O	P	Q	R	S	T	U	(# above U) *	S Nail	M Nail
3675	3699	3723	3747	3771	3795	3819	3843	3867	3891	3915	3939	3963	3987	4011	4035	4059	24 (Riser) + 4059 (U)	45	N/A
Leather 1 5475		Leather 2 5700		Leather 3 5925		Leather 4 6150		Leather 5 6375		Leather 6 6600		Leather 8 8625		COL 3867		S Nail 45		M Nail N/A	

Fabric SKU: **451F-PL** Leather SKU: **L-451F-PL**

RECLINATION

Nolan Power Lift Recliner

Power Recline, Inside Power Switch

Width: 29 **Depth:** 36.5 **Height:** 40.75

AH: 24.5 **SH:** 21 **SD:** 20 **IW:** 20.5 **Recl D:** 66 **TV Recl:** 54.5 **Wall Clr:** 5

Weight: 129 lbs **Cube:** 43.25

Standard Pillows: N/A **Finish Req:** N

Standard Cushions: Repose **Standard Finish:**

COM: 7.5 yards **COL:** 141 square feet

Features Dual Motors

D	E	F	G	H	J	K COM	L	M	N	O	P	Q	R	S	T	U	(# above U) *	S Nail	M Nail
4800	4824	4848	4872	4896	4920	4944	4968	4992	5016	5040	5064	5088	5112	5136	5160	5184	24 (Riser) + 5184 (U)	45	N/A
Leather 1 6450		Leather 2 6660		Leather 3 6870		Leather 4 7080		Leather 5 7290		Leather 6 7500		Leather 8 9450		COL 4992		S Nail 45		M Nail N/A	

Fabric SKU: **451G-MR** Leather SKU: **L-451G-MR**

RECLINATION

Nolan Manual Swivel Glider Recliner

Inside Release Handle

Width: 29 **Depth:** 36.5 **Height:** 40.75

AH: 24.5 **SH:** 21 **SD:** 20 **IW:** 20.5 **Recl D:** 66 **TV Recl:** 54.5 **Wall Clr:** 12

Weight: 129 lbs **Cube:** 29.69

Standard Pillows: N/A **Finish Req:** N

Standard Cushions: Repose **Standard Finish:**

COM: 7.75 yards **COL:** 141 square feet

D	E	F	G	H	J	K COM	L	M	N	O	P	Q	R	S	T	U	(# above U) *	S Nail	M Nail
3600	3624	3648	3672	3696	3720	3744	3768	3792	3816	3840	3864	3888	3912	3936	3960	3984	24 (Riser) + 3984 (U)	45	N/A
Leather 1 5325		Leather 2 5535		Leather 3 5745		Leather 4 5955		Leather 5 6165		Leather 6 6375		Leather 8 8325		COL 3792		S Nail 45		M Nail N/A	

Fabric SKU: **451K-MR** Leather SKU: **L-451K-MR**

RECLINATION

Nolan Manual Glider Recliner

Inside Release Handle

Width: 29 **Depth:** 36.5 **Height:** 40.75

AH: 24.5 **SH:** 21 **SD:** 20 **IW:** 20.5 **Recl D:** 66 **TV Recl:** 54.5 **Wall Clr:** 12

Weight: 129 lbs **Cube:** 24.96

Standard Pillows: N/A **Finish Req:** N

Standard Cushions: Repose **Standard Finish:**

COM: 7.75 yards **COL:** 141 square feet

D	E	F	G	H	J	K COM	L	M	N	O	P	Q	R	S	T	U	(# above U) *	S Nail	M Nail
3600	3624	3648	3672	3696	3720	3744	3768	3792	3816	3840	3864	3888	3912	3936	3960	3984	24 (Riser) + 3984 (U)	45	N/A
Leather 1 5325		Leather 2 5535		Leather 3 5745		Leather 4 5955		Leather 5 6165		Leather 6 6375		Leather 8 8325		COL 3792		S Nail 45		M Nail N/A	

Upholstery

**Pillows are not available on leather SKUs*

Fabric SKU: **451K-PR**

Leather SKU: **L-451K-PR**

RECLINATION

Nolan Power Glider Recliner

with Power Recline

Width: 29 **Depth:** 36.5 **Height:** 40.75

AH: 24.5 **SH:** 21 **SD:** 20 **IW:** 20.5 **Recl D:** 66 **TV Recl:** 54.5 **Wall Clr:** 12

Weight: 129 lbs **Cube:** 24.96

Standard Pillows: N/A **Finish Req:** N

Standard Cushions: Repose **Standard Finish:**

COM: 7.75 yards **COL:** 141 square feet

D	E	F	G	H	J	K COM	L	M	N	O	P	Q	R	S	T	U	(# above U) *	S Nail	M Nail
4050	4074	4098	4122	4146	4170	4194	4218	4242	4266	4290	4314	4338	4362	4386	4410	4434	24 (Riser) + 4434 (U)	45	N/A
Leather 1 5775		Leather 2 5985		Leather 3 6195		Leather 4 6405		Leather 5 6615		Leather 6 6825		Leather 8 8775		COL 4242		S Nail 45		M Nail N/A	

Fabric SKU: **451Z-MR**

Leather SKU: **L-451Z-MR**

RECLINATION

Nolan Manual Wall Hugger Recliner

Zero Wall Recline, Inside Release Handle

Width: 29 **Depth:** 36.5 **Height:** 40.75

AH: 24.5 **SH:** 21 **SD:** 20 **IW:** 20.5 **Recl D:** 66 **TV Recl:** 54.5 **Wall Clr:** 3.5

Weight: 129 lbs **Cube:** 24.96

Standard Pillows: N/A **Finish Req:** N

Standard Cushions: Repose **Standard Finish:**

COM: 7.75 yards **COL:** 141 square feet

D	E	F	G	H	J	K COM	L	M	N	O	P	Q	R	S	T	U	(# above U) *	S Nail	M Nail
3300	3324	3348	3372	3396	3420	3444	3468	3492	3516	3540	3564	3588	3612	3636	3660	3684	24 (Riser) + 3684 (U)	45	N/A
Leather 1 5025		Leather 2 5235		Leather 3 5445		Leather 4 5655		Leather 5 5865		Leather 6 6075		Leather 8 8025		COL 3492		S Nail 45		M Nail N/A	

Fabric SKU: **452F-PL**

Leather SKU: **L-452F-PL**

RECLINATION

Track Arm Power Lift Recliner

Power Recline, Inside Power Switch

Width: 29 **Depth:** 36.5 **Height:** 40.75

AH: 24.5 **SH:** 18.5 **SD:** 21 **IW:** 20.5 **Recl D:** 66 **TV Recl:** 54.5 **Wall Clr:** 5

Weight: 123 lbs **Cube:** 24.96

Standard Pillows: N/A **Finish Req:** N

Standard Cushions: Endurance **Standard Finish:**

COM: 7.5 yards **COL:** 124 square feet

Features Dual Motors and a lift motion control switch on the inside of the left side facing arm.

D	E	F	G	H	J	K COM	L	M	N	O	P	Q	R	S	T	U	(# above U) *	S Nail	M Nail
4875	4896	4917	4938	4959	4980	5001	5022	5043	5064	5085	5106	5127	5148	5169	5190	5211	21 (Riser) + 5211 (U)	N/A	N/A
Leather 1 6450		Leather 2 6645		Leather 3 6840		Leather 4 7035		Leather 5 7230		Leather 6 7425		Leather 8 9135		COL 5043		S Nail N/A		M Nail N/A	

Fabric SKU: **452G-MR**

Leather SKU: **L-452G-MR**

RECLINATION

Track Arm Manual Swivel Glider Recliner

Inside Release Handle

Width: 29 **Depth:** 36.5 **Height:** 40.75

AH: 24.5 **SH:** 20.25 **SD:** 21 **IW:** 20.5 **Recl D:** 66 **TV Recl:** 54.5 **Wall Clr:** 12

Weight: 123 lbs **Cube:** 43.25

Standard Pillows: N/A **Finish Req:** N

Standard Cushions: Repose **Standard Finish:**

COM: 7.5 yards **COL:** 124 square feet

D	E	F	G	H	J	K COM	L	M	N	O	P	Q	R	S	T	U	(# above U) *	S Nail	M Nail
3600	3621	3642	3663	3684	3705	3726	3747	3768	3789	3810	3831	3852	3873	3894	3915	3936	21 (Riser) + 3936 (U)	N/A	N/A
Leather 1 5175		Leather 2 5370		Leather 3 5565		Leather 4 5760		Leather 5 5955		Leather 6 6150		Leather 8 7860		COL 3768		S Nail N/A		M Nail N/A	

Fabric SKU: **452K-MR**

Leather SKU: **L-452K-MR**

RECLINATION

Track Arm Manual Glider Recliner

Inside Release Handle

Width: 29 **Depth:** 36.5 **Height:** 40.75

AH: 24.5 **SH:** 20.25 **SD:** 21 **IW:** 20.5 **Recl D:** 66 **TV Recl:** 54.5 **Wall Clr:** 12

Weight: 123 lbs **Cube:** 24.96

Standard Pillows: N/A **Finish Req:** N

Standard Cushions: Repose **Standard Finish:**

COM: 7.5 yards **COL:** 124 square feet

D	E	F	G	H	J	K COM	L	M	N	O	P	Q	R	S	T	U	(# above U) *	S Nail	M Nail
3600	3621	3642	3663	3684	3705	3726	3747	3768	3789	3810	3831	3852	3873	3894	3915	3936	21 (Riser) + 3936 (U)	N/A	N/A
Leather 1 5100		Leather 2 5295		Leather 3 5490		Leather 4 5685		Leather 5 5880		Leather 6 6075		Leather 8 7785		COL 3768		S Nail N/A		M Nail N/A	

Fabric SKU: **452K-PR**

Leather SKU: **L-452K-PR**

RECLINATION

Track Arm Power Glider Recliner

with Power Recline

Width: 29 **Depth:** 36.5 **Height:** 40.75

AH: 24.5 **SH:** 20.25 **SD:** 21 **IW:** 20.5 **Recl D:** 66 **TV Recl:** 54.5 **Wall Clr:** 12

Weight: 123 lbs **Cube:** 24.96

Standard Pillows: N/A **Finish Req:** N

Standard Cushions: Repose **Standard Finish:**

COM: 7.5 yards **COL:** 124 square feet

Features a motor control switch on the inside of the left side facing arm.

D	E	F	G	H	J	K COM	L	M	N	O	P	Q	R	S	T	U	(# above U) *	S Nail	M Nail
4050	4071	4092	4113	4134	4155	4176	4197	4218	4239	4260	4281	4302	4323	4344	4365	4386	21 (Riser) + 4386 (U)	N/A	N/A
Leather 1 5550		Leather 2 5745		Leather 3 5940		Leather 4 6135		Leather 5 6330		Leather 6 6525		Leather 8 8235		COL 4218		S Nail N/A		M Nail N/A	

Upholstery

**Pillows are not available on leather SKUs*

Fabric SKU: **452Z-MR**

Leather SKU: **L-452Z-MR**

RECLINATION

Track Arm Manual Wall Hugger Recliner

Inside Release Handle

Width: 29 **Depth:** 36.5 **Height:** 40.75

AH: 24.5 **SH:** 20.25 **SD:** 21 **IW:** 20.5 **Recl D:** 66 **TV Recl:** 54.5 **Wall Clr:** 3.5

Weight: 123 lbs **Cube:** 24.96

Standard Pillows: N/A **Finish Req:** N

Standard Cushions: Repose **Standard Finish:**

COM: 7.5 yards **COL:** 124 square feet

D	E	F	G	H	J	K COM	L	M	N	O	P	Q	R	S	T	U	(# above U) *	S Nail	M Nail
3300	3321	3342	3363	3384	3405	3426	3447	3468	3489	3510	3531	3552	3573	3594	3615	3636	21 (Riser) + 3636 (U)	N/A	N/A
Leather 1 4875		Leather 2 5070		Leather 3 5265		Leather 4 5460		Leather 5 5655		Leather 6 5850		Leather 8 7560		COL 3468		S Nail N/A		M Nail N/A	

Fabric SKU: **453G-MR**

Leather SKU: **L-453G-MR**

RECLINATION

Greek Key Arm Manual Swivel Glider Recliner

Inside Release Handle

Width: 32.5 **Depth:** 36.5 **Height:** 40.75

AH: 24.25 **SH:** 20.25 **SD:** 21 **IW:** 20.5 **Recl D:** 66 **TV Recl:** 54.5 **Wall Clr:** 12

Weight: 123 lbs **Cube:** 43.25

Standard Pillows: N/A **Finish Req:** N

Standard Cushions: Repose **Standard Finish:**

COM: 7.5 yards **COL:** 130 square feet

D	E	F	G	H	J	K COM	L	M	N	O	P	Q	R	S	T	U	(# above U) *	S Nail	M Nail
3600	3621	3642	3663	3684	3705	3726	3747	3768	3789	3810	3831	3852	3873	3894	3915	3936	21 (Riser) + 3936 (U)	N/A	N/A
Leather 1 5175		Leather 2 5370		Leather 3 5565		Leather 4 5760		Leather 5 5955		Leather 6 6150		Leather 8 7935		COL 3768		S Nail N/A		M Nail N/A	

Fabric SKU: **454F-PL**

Leather SKU: **L-454F-PL**

RECLINATION

Modern Arm Power Lift Recliner

with Power Lift and Recline

Width: 31.5 **Depth:** 36.5 **Height:** 40.75

AH: 24.75 **SH:** 18.5 **SD:** 21 **IW:** 20.5 **Recl D:** 66 **TV Recl:** 54.5 **Wall Clr:** 5

Weight: 123 lbs **Cube:** 34.38

Standard Pillows: N/A **Finish Req:** N

Standard Cushions: Endurance **Standard Finish:**

COM: 7.5 yards **COL:** 124 square feet

Features dual motors and a lift motion control switch on the top of the left side facing arm.

D	E	F	G	H	J	K COM	L	M	N	O	P	Q	R	S	T	U	(# above U) *	S Nail	M Nail
4950	4971	4992	5013	5034	5055	5076	5097	5118	5139	5160	5181	5202	5223	5244	5265	5286	21 (Riser) + 5286 (U)	N/A	N/A
Leather 1 6375		Leather 2 6570		Leather 3 6765		Leather 4 6960		Leather 5 7155		Leather 6 7350		Leather 8 9060		COL 5118		S Nail N/A		M Nail N/A	

Fabric SKU: **454G-MR**

Leather SKU: **L-454G-MR**

RECLINATION

Modern Arm Manual Swivel Glider Recliner

Inside Release Handle

Width: 31.5 **Depth:** 36.5 **Height:** 40.75

AH: 24.75 **SH:** 20.25 **SD:** 21 **IW:** 20.5 **Recl D:** 66 **TV Recl:** 54.5 **Wall Clr:** 12

Weight: 123 lbs **Cube:** 27.11

Standard Pillows: N/A **Finish Req:** N

Standard Cushions: Repose **Standard Finish:**

COM: 7.5 yards **COL:** 124 square feet

D	E	F	G	H	J	K COM	L	M	N	O	P	Q	R	S	T	U	(# above U) *	S Nail	M Nail
3600	3621	3642	3663	3684	3705	3726	3747	3768	3789	3810	3831	3852	3873	3894	3915	3936	21 (Riser) + 3936 (U)	N/A	N/A
Leather 1 5175		Leather 2 5370		Leather 3 5565		Leather 4 5760		Leather 5 5955		Leather 6 6150		Leather 8 7860		COL 3768		S Nail N/A		M Nail N/A	

Fabric SKU: **454Z-MR**

Leather SKU: **L-454Z-MR**

RECLINATION

Modern Arm Manual Wall Hugger Recliner

Zero Wall Recline, Inside Release Handle

Width: 31.5 **Depth:** 36.5 **Height:** 40.75

AH: 24.75 **SH:** 20.25 **SD:** 21 **IW:** 20.5 **Recl D:** 66 **TV Recl:** 54.5 **Wall Clr:** 3.5

Weight: 123 lbs **Cube:** 43.25

Standard Pillows: N/A **Finish Req:** N

Standard Cushions: Repose **Standard Finish:**

COM: 7.5 yards **COL:** 124 square feet

D	E	F	G	H	J	K COM	L	M	N	O	P	Q	R	S	T	U	(# above U) *	S Nail	M Nail
3300	3321	3342	3363	3384	3405	3426	3447	3468	3489	3510	3531	3552	3573	3594	3615	3636	21 (Riser) + 3636 (U)	N/A	N/A
Leather 1 4875		Leather 2 5070		Leather 3 5265		Leather 4 5460		Leather 5 5655		Leather 6 5850		Leather 8 7560		COL 3468		S Nail N/A		M Nail N/A	

Fabric SKU: **455G-MR**

Leather SKU: **L-455G-MR**

RECLINATION

Hickory Arm Manual Swivel Glider Recliner

Inside Release Handle

Width: 31 **Depth:** 36.5 **Height:** 40.75

AH: 24.75 **SH:** 20.25 **SD:** 21 **IW:** 20.5 **Recl D:** 66 **TV Recl:** 54.5 **Wall Clr:** 12

Weight: 123 lbs **Cube:** 26.68

Standard Pillows: N/A **Finish Req:** N

Standard Cushions: Repose **Standard Finish:**

COM: 7.5 yards **COL:** 130 square feet

D	E	F	G	H	J	K COM	L	M	N	O	P	Q	R	S	T	U	(# above U) *	S Nail	M Nail
3600	3621	3642	3663	3684	3705	3726	3747	3768	3789	3810	3831	3852	3873	3894	3915	3936	21 (Riser) + 3936 (U)	N/A	N/A
Leather 1 5175		Leather 2 5370		Leather 3 5565		Leather 4 5760		Leather 5 5955		Leather 6 6150		Leather 8 7935		COL 3768		S Nail N/A		M Nail N/A	

Upholstery

**Pillows are not available on leather SKUs*

Fabric SKU: **456F-PL**

Leather SKU: **L-456F-PL**

RECLINATION

Roll Arm Power Lift Recliner

with Power Lift and Recline

Width: 32.5 **Depth:** 36.5 **Height:** 40.75

AH: 25 **SH:** 18.5 **SD:** 21 **IW:** 20.5 **Recl D:** 66 **TV Recl:** 54.5 **Wall Clr:** 5

Weight: 123 lbs **Cube:** 27.97

Standard Pillows: N/A **Finish Req:** N

Standard Cushions: Endurance **Standard Finish:**

COM: 7.5 yards **COL:** 130 square feet

Features dual motors and a lift motion control switch on the top of the left side facing arm.

D	E	F	G	H	J	K COM	L	M	N	O	P	Q	R	S	T	U	(# above U) *	S Nail	M Nail
4950	4971	4992	5013	5034	5055	5076	5097	5118	5139	5160	5181	5202	5223	5244	5265	5286	21 (Riser) + 5286 (U)	45	N/A
Leather 1		Leather 2		Leather 3		Leather 4		Leather 5		Leather 6		Leather 8		COL		S Nail		M Nail	
6450		6645		6840		7035		7230		7425		9210		5118		45		N/A	

Fabric SKU: **456G-MR**

Leather SKU: **L-456G-MR**

RECLINATION

Roll Arm Manual Swivel Glider Recliner

Inside Release Handle

Width: 32.5 **Depth:** 36.5 **Height:** 40.75

AH: 25 **SH:** 20.25 **SD:** 21 **IW:** 20.5 **Recl D:** 66 **TV Recl:** 54.5 **Wall Clr:** 12

Weight: 123 lbs **Cube:** 27.97

Standard Pillows: N/A **Finish Req:** N

Standard Cushions: Repose **Standard Finish:**

COM: 7.75 yards **COL:** 130 square feet

D	E	F	G	H	J	K COM	L	M	N	O	P	Q	R	S	T	U	(# above U) *	S Nail	M Nail
3600	3621	3642	3663	3684	3705	3726	3747	3768	3789	3810	3831	3852	3873	3894	3915	3936	21 (Riser) + 3936 (U)	45	N/A
Leather 1		Leather 2		Leather 3		Leather 4		Leather 5		Leather 6		Leather 8		COL		S Nail		M Nail	
5175		5370		5565		5760		5955		6150		7935		3768		45		N/A	

Fabric SKU: **456K-MR**

Leather SKU: **L-456K-MR**

RECLINATION

Roll Arm Manual Glider Recliner

Inside Release Handle

Width: 32.5 **Depth:** 36.5 **Height:** 40.75

AH: 25 **SH:** 20.25 **SD:** 21 **IW:** 20.5 **Recl D:** 66 **TV Recl:** 54.5 **Wall Clr:** 12

Weight: 123 lbs **Cube:** 27.97

Standard Pillows: N/A **Finish Req:** N

Standard Cushions: Repose **Standard Finish:**

COM: 7.75 yards **COL:** 141 square feet

D	E	F	G	H	J	K COM	L	M	N	O	P	Q	R	S	T	U	(# above U) *	S Nail	M Nail
3600	3621	3642	3663	3684	3705	3726	3747	3768	3789	3810	3831	3852	3873	3894	3915	3936	21 (Riser) + 3936 (U)	45	N/A
Leather 1		Leather 2		Leather 3		Leather 4		Leather 5		Leather 6		Leather 8		COL		S Nail		M Nail	
5175		5385		5595		5805		6015		6225		8175		3768		45		N/A	

Fabric SKU: **456K-PR**

Leather SKU: **L-456K-PR**

RECLINATION

Roll Arm Power Glider Recliner

with Power Recline

Width: 32.5 **Depth:** 36.5 **Height:** 40.75

AH: 25 **SH:** 20.25 **SD:** 21 **IW:** 20.5 **Recl D:** 66 **TV Recl:** 54.5 **Wall Clr:** 12

Weight: 123 lbs **Cube:** 27.97

Standard Pillows: N/A **Finish Req:** N

Standard Cushions: Repose **Standard Finish:**

COM: 7.75 yards **COL:** 141 square feet

Features a motion control switch on the outside of the left side facing arm.

D	E	F	G	H	J	K COM	L	M	N	O	P	Q	R	S	T	U	(# above U) *	S Nail	M Nail
4050	4071	4092	4113	4134	4155	4176	4197	4218	4239	4260	4281	4302	4323	4344	4365	4386	21 (Riser) + 4386 (U)	45	N/A
Leather 1		Leather 2		Leather 3		Leather 4		Leather 5		Leather 6		Leather 8		COL		S Nail		M Nail	
5625		5835		6045		6255		6465		6675		8625		4218		45		N/A	

Fabric SKU: **456Z-MR**

Leather SKU: **L-456Z-MR**

RECLINATION

Roll Arm Manual Wall Hugger Recliner

Zero Wall Recline, Inside Release Handle

Width: 32.5 **Depth:** 36.5 **Height:** 40.75

AH: 25 **SH:** 20.25 **SD:** 21 **IW:** 20.5 **Recl D:** 66 **TV Recl:** 54.5 **Wall Clr:** 3.5

Weight: 123 lbs **Cube:** 43.25

Standard Pillows: N/A **Finish Req:** N

Standard Cushions: Repose **Standard Finish:**

COM: 7.75 yards **COL:** 141 square feet

D	E	F	G	H	J	K COM	L	M	N	O	P	Q	R	S	T	U	(# above U) *	S Nail	M Nail
3300	3321	3342	3363	3384	3405	3426	3447	3468	3489	3510	3531	3552	3573	3594	3615	3636	21 (Riser) + 3636 (U)	45	N/A
Leather 1		Leather 2		Leather 3		Leather 4		Leather 5		Leather 6		Leather 8		COL		S Nail		M Nail	
5100		5310		5520		5730		5940		6150		8100		3468		45		N/A	

Fabric SKU: **457G-MR**

Leather SKU: **N/A**

RECLINATION

Lulu Manual Swivel Glider Recliner

Inside Release Handle

Width: 28.5 **Depth:** 39 **Height:** 38.5

AH: 26.5 **SH:** 21 **SD:** 21 **IW:** 21.5 **Recl D:** 69 **TV Recl:** 0 **Wall Clr:** 11

Weight: 115 lbs **Cube:** 41.32

Standard Pillows: N/A **Finish Req:** N

Standard Cushions: Blendown **Standard Finish:**

COM: 6.75 yards **COL:** N/A

*Flange seam detail on loose seat cushion and semi-attached back pillow.

D	E	F	G	H	J	K COM	L	M	N	O	P	Q	R	S	T	U	(# above U) *	S Nail	M Nail
2850	2874	2898	2922	2946	2970	2994	3018	3042	3066	3090	3114	3138	3162	3186	3210	3234	24 (Riser) + 3234 (U)	N/A	N/A
Leather 1		Leather 2		Leather 3		Leather 4		Leather 5		Leather 6		Leather 8		COL		S Nail		M Nail	
N/A		N/A		N/A		N/A		N/A		N/A		N/A		N/A		N/A		N/A	

Upholstery

**Pillows are not available on leather SKUs*

Fabric SKU: **462C-MR**
RECLINATION
Loft Manual Push Back Recliner

Leather SKU: **L-462C-MR**

Standard Pillows: N/A **Finish Req:** Y
Standard Cushions: Repose **Standard Finish:**
COM: 7 yards **COL:** 119 square feet

Width: 29.5 **Depth:** 35 **Height:** 41.5
AH: 24 **SH:** 21.25 **SD:** 21 **IW:** 21.25 **Recl D:** 65 **TV Recl:** 56 **Wall Clr:** 12
Weight: 95 lbs **Cube:** 34.38

D	E	F	G	H	J	K COM	L	M	N	O	P	Q	R	S	T	U	(# above U) *	S Nail	M Nail
3300	3321	3342	3363	3384	3405	3426	3447	3468	3489	3510	3531	3552	3573	3594	3615	3636	21	N/A	N/A
Leather 1 4725		Leather 2 4905		Leather 3 5085		Leather 4 5265		Leather 5 5445		Leather 6 5625		Leather 8 7260		COL 3468		S Nail N/A		M Nail N/A	

Fabric SKU: **462C-PR**
RECLINATION
Loft Power Recliner
with Power Recline

Leather SKU: **L-462C-PR**

Standard Pillows: N/A **Finish Req:** Y
Standard Cushions: Repose **Standard Finish:**
COM: 7 yards **COL:** 119 square feet
Features a motion control switch on the outside of the left side facing arm.

Width: 29.5 **Depth:** 35 **Height:** 41.5
AH: 24 **SH:** 21.25 **SD:** 21 **IW:** 21.25 **Recl D:** 65 **TV Recl:** 56 **Wall Clr:** 12
Weight: 95 lbs **Cube:** 34.38

D	E	F	G	H	J	K COM	L	M	N	O	P	Q	R	S	T	U	(# above U) *	S Nail	M Nail
3750	3771	3792	3813	3834	3855	3876	3897	3918	3939	3960	3981	4002	4023	4044	4065	4086	21 (Riser) + 4086 (U)	N/A	N/A
Leather 1 5175		Leather 2 5355		Leather 3 5535		Leather 4 5715		Leather 5 5895		Leather 6 6075		Leather 8 7710		COL 3918		S Nail N/A		M Nail N/A	

Fabric SKU: **462P-MR-1**
RECLINATION
Loft Manual Push Back Swivel Recliner
with Bronze Five Prong Base

Leather SKU: **L-462P-MR-1**

Standard Pillows: N/A **Finish Req:** Y
Standard Cushions: Repose **Standard Finish:**
COM: 6.75 yards **COL:** 119 square feet
Metal Prong Base in Bronze

Width: 29.5 **Depth:** 35 **Height:** 41.5
AH: 24 **SH:** 21.25 **SD:** 21 **IW:** 21.25 **Recl D:** 65 **TV Recl:** 56 **Wall Clr:** 12
Weight: 95 lbs **Cube:** 34.38

D	E	F	G	H	J	K COM	L	M	N	O	P	Q	R	S	T	U	(# above U) *	S Nail	M Nail
3675	3693	3711	3729	3747	3765	3783	3801	3819	3837	3855	3873	3891	3909	3927	3945	3963	18 (Riser) + 3963 (U)	N/A	N/A
Leather 1 5100		Leather 2 5280		Leather 3 5460		Leather 4 5640		Leather 5 5820		Leather 6 6000		Leather 8 7635		COL 3819		S Nail N/A		M Nail N/A	

Fabric SKU: **462P-MR-2**
RECLINATION
Loft Manual Push Back Swivel Recliner
with Brushed Nickel Five Prong Base

Leather SKU: **L-462P-MR-2**

Standard Pillows: N/A **Finish Req:** Y
Standard Cushions: Repose **Standard Finish:**
COM: 6.75 yards **COL:** 119 square feet
Metal Prong Base in Brushed Nickel

Width: 29.5 **Depth:** 35 **Height:** 41.5
AH: 24 **SH:** 21.25 **SD:** 21 **IW:** 21.25 **Recl D:** 65 **TV Recl:** 56 **Wall Clr:** 12
Weight: 95 lbs **Cube:** 24.79

D	E	F	G	H	J	K COM	L	M	N	O	P	Q	R	S	T	U	(# above U) *	S Nail	M Nail
3675	3693	3711	3729	3747	3765	3783	3801	3819	3837	3855	3873	3891	3909	3927	3945	3963	18 (Riser) + 3963 (U)	N/A	N/A
Leather 1 5100		Leather 2 5280		Leather 3 5460		Leather 4 5640		Leather 5 5820		Leather 6 6000		Leather 8 7635		COL 3819		S Nail N/A		M Nail N/A	

Fabric SKU: **462P-MR-7**
RECLINATION
Loft Manual Push Back Swivel Recliner
with Bright Brass Five Prong Base

Leather SKU: **L-462P-MR-7**

Standard Pillows: N/A **Finish Req:** Y
Standard Cushions: Repose **Standard Finish:**
COM: 6.75 yards **COL:** 119 square feet
Metal Prong Base in Bright Brass

Width: 29.5 **Depth:** 35 **Height:** 41.5
AH: 24 **SH:** 21.25 **SD:** 21 **IW:** 21.25 **Recl D:** 65 **TV Recl:** 56 **Wall Clr:** 12
Weight: 95 lbs **Cube:** 24.79

D	E	F	G	H	J	K COM	L	M	N	O	P	Q	R	S	T	U	(# above U) *	S Nail	M Nail
3675	3693	3711	3729	3747	3765	3783	3801	3819	3837	3855	3873	3891	3909	3927	3945	3963	18 (Riser) + 3963 (U)	N/A	N/A
Leather 1 5100		Leather 2 5280		Leather 3 5460		Leather 4 5640		Leather 5 5820		Leather 6 6000		Leather 8 7635		COL 3819		S Nail N/A		M Nail N/A	

Fabric SKU: **462P-PR-1**
RECLINATION
Loft Power Swivel Recliner
with Bronze Five Prong Base

Leather SKU: **L-462P-PR-1**

Standard Pillows: N/A **Finish Req:** Y
Standard Cushions: Repose **Standard Finish:**
COM: 6.75 yards **COL:** 119 square feet
Metal Prong Base in Bronze

Width: 29.5 **Depth:** 35 **Height:** 41.5
AH: 24 **SH:** 21.25 **SD:** 21 **IW:** 21.25 **Recl D:** 65 **TV Recl:** 56 **Wall Clr:** 12
Weight: 95 lbs **Cube:** 34.38

D	E	F	G	H	J	K COM	L	M	N	O	P	Q	R	S	T	U	(# above U) *	S Nail	M Nail
4125	4143	4161	4179	4197	4215	4233	4251	4269	4287	4305	4323	4341	4359	4377	4395	4413	18 (Riser) + 4413 (U)	N/A	N/A
Leather 1 5550		Leather 2 5730		Leather 3 5910		Leather 4 6090		Leather 5 6270		Leather 6 6450		Leather 8 8085		COL 4269		S Nail N/A		M Nail N/A	

Upholstery

**Pillows are not available on leather SKUs*

Fabric SKU: **462P-PR-2**

Leather SKU: **L-462P-PR-2**

RECLINATION

Loft Power Swivel Recliner

with Brushed Nickel Five Prong Base

Width: 29.5 **Depth:** 35 **Height:** 41.5

AH: 24 **SH:** 21.25 **SD:** 21 **IW:** 21.25 **Recl D:** 65 **TV Recl:** 56 **Wall Clr:** 12

Weight: 95 lbs **Cube:** 34.38

Standard Pillows: N/A **Finish Req:** Y

Standard Cushions: Repose **Standard Finish:**

COM: 6.75 yards **COL:** 119 square feet

Metal Prong Base in Brushed Nickel

D	E	F	G	H	J	K COM	L	M	N	O	P	Q	R	S	T	U	(# above U) *	S Nail	M Nail
4125	4143	4161	4179	4197	4215	4233	4251	4269	4287	4305	4323	4341	4359	4377	4395	4413	18 (Riser) + 4413 (U)	N/A	N/A
Leather 1 5550		Leather 2 5730		Leather 3 5910		Leather 4 6090		Leather 5 6270		Leather 6 6450		Leather 8 8085		COL 4269		S Nail N/A		M Nail N/A	

Fabric SKU: **462P-PR-7**

Leather SKU: **L-462P-PR-7**

RECLINATION

Loft Power Swivel Recliner

with Bright Brass Five Prong Base

Width: 29.5 **Depth:** 35 **Height:** 41.5

AH: 24 **SH:** 21.25 **SD:** 21 **IW:** 21.25 **Recl D:** 65 **TV Recl:** 56 **Wall Clr:** 12

Weight: 95 lbs **Cube:** 34.38

Standard Pillows: N/A **Finish Req:** Y

Standard Cushions: Repose **Standard Finish:**

COM: 6.75 yards **COL:** 119 square feet

Metal Prong Base in Bright Brass

D	E	F	G	H	J	K COM	L	M	N	O	P	Q	R	S	T	U	(# above U) *	S Nail	M Nail
4125	4143	4161	4179	4197	4215	4233	4251	4269	4287	4305	4323	4341	4359	4377	4395	4413	18 (Riser) + 4413 (U)	N/A	N/A
Leather 1 5550		Leather 2 5730		Leather 3 5910		Leather 4 6090		Leather 5 6270		Leather 6 6450		Leather 8 8085		COL 4269		S Nail N/A		M Nail N/A	

Fabric SKU: **464C-MR**

Leather SKU: **L-464C-MR**

RECLINATION

Aspire Manual Push Back Recliner

Width: 29.5 **Depth:** 33.25 **Height:** 42

AH: 22.5 **SH:** 21.5 **SD:** 19.5 **IW:** 22 **Recl D:** 62.5 **TV Recl:** 54 **Wall Clr:** 12

Weight: 95 lbs **Cube:** 23.84

Standard Pillows: N/A **Finish Req:** Y

Standard Cushions: Repose **Standard Finish:**

COM: 8 yards **COL:** 124 square feet

D	E	F	G	H	J	K COM	L	M	N	O	P	Q	R	S	T	U	(# above U) *	S Nail	M Nail
3600	3624	3648	3672	3696	3720	3744	3768	3792	3816	3840	3864	3888	3912	3936	3960	3984	24 (Riser) + 3984 (U)	N/A	N/A
Leather 1 4875		Leather 2 5070		Leather 3 5265		Leather 4 5460		Leather 5 5655		Leather 6 5850		Leather 8 7560		COL 3792		S Nail N/A		M Nail N/A	

Fabric SKU: **464P-MR-1**

Leather SKU: **L-464P-MR-1**

RECLINATION

Aspire Manual Swivel Recliner

with Bronze Five Prong Base

Width: 29.5 **Depth:** 33.25 **Height:** 42

AH: 22.5 **SH:** 21.5 **SD:** 19.5 **IW:** 22 **Recl D:** 62.5 **TV Recl:** 54 **Wall Clr:** 12

Weight: 95 lbs **Cube:** 23.84

Standard Pillows: N/A **Finish Req:** N

Standard Cushions: Repose **Standard Finish:** Bronze

COM: 7.25 yards **COL:** 124 square feet

Metal Prong Base in Bronze

D	E	F	G	H	J	K COM	L	M	N	O	P	Q	R	S	T	U	(# above U) *	S Nail	M Nail
3675	3699	3723	3747	3771	3795	3819	3843	3867	3891	3915	3939	3963	3987	4011	4035	4059	24 (Riser) + 4059 (U)	N/A	N/A
Leather 1 5025		Leather 2 5220		Leather 3 5415		Leather 4 5610		Leather 5 5805		Leather 6 6000		Leather 8 7710		COL 3867		S Nail N/A		M Nail N/A	

Fabric SKU: **464P-MR-2**

Leather SKU: **L-464P-MR-2**

RECLINATION

Aspire Manual Swivel Recliner

with Brushed Nickel Five Prong Base

Width: 29.5 **Depth:** 33.25 **Height:** 42

AH: 22.5 **SH:** 21.5 **SD:** 19.5 **IW:** 22 **Recl D:** 62.5 **TV Recl:** 54 **Wall Clr:** 12

Weight: 95 lbs **Cube:** 34.38

Standard Pillows: N/A **Finish Req:** N

Standard Cushions: Repose **Standard Finish:** Brushed Nickel

COM: 7.25 yards **COL:** 124 square feet

Metal Prong Base in Brushed Nickel

D	E	F	G	H	J	K COM	L	M	N	O	P	Q	R	S	T	U	(# above U) *	S Nail	M Nail
3675	3699	3723	3747	3771	3795	3819	3843	3867	3891	3915	3939	3963	3987	4011	4035	4059	24 (Riser) + 4059 (U)	N/A	N/A
Leather 1 5025		Leather 2 5220		Leather 3 5415		Leather 4 5610		Leather 5 5805		Leather 6 6000		Leather 8 7710		COL 3867		S Nail N/A		M Nail N/A	

Fabric SKU: **464P-PR-1**

Leather SKU: **L-464P-PR-1**

RECLINATION

Aspire Power Swivel Recliner

with Bronze Five Prong Base

Width: 29.5 **Depth:** 33.25 **Height:** 42

AH: 22.5 **SH:** 21.5 **SD:** 19.5 **IW:** 22 **Recl D:** 62.5 **TV Recl:** 54 **Wall Clr:** 12

Weight: 95 lbs **Cube:** 34.38

Standard Pillows: N/A **Finish Req:** N

Standard Cushions: Repose **Standard Finish:** Bronze

COM: 7.25 yards **COL:** 124 square feet

Metal Prong Base in Bronze

D	E	F	G	H	J	K COM	L	M	N	O	P	Q	R	S	T	U	(# above U) *	S Nail	M Nail
4125	4149	4173	4197	4221	4245	4269	4293	4317	4341	4365	4389	4413	4437	4461	4485	4509	24 (Riser) + 4509 (U)	N/A	N/A
Leather 1 5475		Leather 2 5670		Leather 3 5865		Leather 4 6060		Leather 5 6255		Leather 6 6450		Leather 8 8160		COL 4317		S Nail N/A		M Nail N/A	

Upholstery

**Pillows are not available on leather SKUs*

Fabric SKU: **464P-PR-2**

Leather SKU: **L-464P-PR-2**

RECLINATION

Aspire Power Swivel Recliner

with Brushed Nickel Five Prong Base

Width: 29.5 **Depth:** 33.25 **Height:** 42

AH: 22.5 **SH:** 21.5 **SD:** 19.5 **IW:** 22 **Recl D:** 62.5 **TV Recl:** 54 **Wall Clr:** 12

Weight: 95 lbs **Cube:** 23.84

Standard Pillows: N/A **Finish Req:** N

Standard Cushions: Repose **Standard Finish:** Brushed Nickel

COM: 7.25 yards **COL:** 124 square feet

Metal Prong Base in Brushed Nickel

D	E	F	G	H	J	K COM	L	M	N	O	P	Q	R	S	T	U	(# above U) *	S Nail	M Nail
4125	4149	4173	4197	4221	4245	4269	4293	4317	4341	4365	4389	4413	4437	4461	4485	4509	24 (Riser) + 4509 (U)	N/A	N/A
Leather 1 5475		Leather 2 5670		Leather 3 5865		Leather 4 6060		Leather 5 6255		Leather 6 6450		Leather 8 8160		COL 4317		S Nail N/A		M Nail N/A	

Fabric SKU: **465C-MR**

Leather SKU: **L-465C-MR**

RECLINATION

Margo Manual Push Back Recliner

Width: 31.5 **Depth:** 33.25 **Height:** 39.75

AH: 23.75 **SH:** 20.75 **SD:** 18 **IW:** 22 **Recl D:** 67 **TV Recl:** 57 **Wall Clr:** 12

Weight: 99 lbs **Cube:** 24.09

Standard Pillows: N/A **Finish Req:** Y

Standard Cushions: Repose **Standard Finish:**

COM: 7.25 yards **COL:** 130 square feet

D	E	F	G	H	J	K COM	L	M	N	O	P	Q	R	S	T	U	(# above U) *	S Nail	M Nail
3600	3624	3648	3672	3696	3720	3744	3768	3792	3816	3840	3864	3888	3912	3936	3960	3984	24 (Riser) + 3984 (U)	N/A	N/A
Leather 1 5100		Leather 2 5295		Leather 3 5490		Leather 4 5685		Leather 5 5880		Leather 6 6075		Leather 8 7860		COL 3792		S Nail N/A		M Nail N/A	

Fabric SKU: **465C-PR**

Leather SKU: **L-465C-PR**

RECLINATION

Margo Power Recliner

with Power Recline

Width: 31.5 **Depth:** 33.25 **Height:** 39.75

AH: 23.75 **SH:** 20.75 **SD:** 18 **IW:** 22 **Recl D:** 67 **TV Recl:** 57 **Wall Clr:** 12

Weight: 99 lbs **Cube:** 24.09

Standard Pillows: N/A **Finish Req:** Y

Standard Cushions: Repose **Standard Finish:**

COM: 7.25 yards **COL:** 130 square feet

D	E	F	G	H	J	K COM	L	M	N	O	P	Q	R	S	T	U	(# above U) *	S Nail	M Nail
4050	4074	4098	4122	4146	4170	4194	4218	4242	4266	4290	4314	4338	4362	4386	4410	4434	24 (Riser) + 4434 (U)	N/A	N/A
Leather 1 5550		Leather 2 5745		Leather 3 5940		Leather 4 6135		Leather 5 6330		Leather 6 6525		Leather 8 8310		COL 4242		S Nail N/A		M Nail N/A	

Fabric SKU: **465P-MR-1**

Leather SKU: **L-465P-MR-1**

RECLINATION

Margo Manual Swivel Recliner

with Bronze Five Prong Base

Width: 31.5 **Depth:** 33.25 **Height:** 39.75

AH: 23.75 **SH:** 20.75 **SD:** 18 **IW:** 22 **Recl D:** 67 **TV Recl:** 57 **Wall Clr:** 12

Weight: 99 lbs **Cube:** 24.09

Standard Pillows: N/A **Finish Req:** N

Standard Cushions: Repose **Standard Finish:** Bronze

COM: 7.25 yards **COL:** 130 square feet

Metal Prong Base in Bronze

D	E	F	G	H	J	K COM	L	M	N	O	P	Q	R	S	T	U	(# above U) *	S Nail	M Nail
3750	3774	3798	3822	3846	3870	3894	3918	3942	3966	3990	4014	4038	4062	4086	4110	4134	24 (Riser) + 4134 (U)	N/A	N/A
Leather 1 5400		Leather 2 5595		Leather 3 5790		Leather 4 5985		Leather 5 6180		Leather 6 6375		Leather 8 8160		COL 3942		S Nail N/A		M Nail N/A	

Fabric SKU: **465P-MR-2**

Leather SKU: **L-465P-MR-2**

RECLINATION

Margo Manual Swivel Recliner

with Brushed Nickel Five Prong Base

Width: 31.5 **Depth:** 33.25 **Height:** 39.75

AH: 23.75 **SH:** 20.75 **SD:** 18 **IW:** 22 **Recl D:** 67 **TV Recl:** 57 **Wall Clr:** 12

Weight: 99 lbs **Cube:** 24.09

Standard Pillows: N/A **Finish Req:** N

Standard Cushions: Repose **Standard Finish:** Brushed Nickel

COM: 7.25 yards **COL:** 130 square feet

Metal Prong Base in Brushed Nickel

D	E	F	G	H	J	K COM	L	M	N	O	P	Q	R	S	T	U	(# above U) *	S Nail	M Nail
3750	3774	3798	3822	3846	3870	3894	3918	3942	3966	3990	4014	4038	4062	4086	4110	4134	24 (Riser) + 4134 (U)	N/A	N/A
Leather 1 5400		Leather 2 5595		Leather 3 5790		Leather 4 5985		Leather 5 6180		Leather 6 6375		Leather 8 8160		COL 3942		S Nail N/A		M Nail N/A	

Fabric SKU: **465P-PR-2**

Leather SKU: **L-465P-PR-2**

RECLINATION

Margo Power Swivel Recliner

with Brushed Nickel Five Prong Base

Width: 31.5 **Depth:** 33.25 **Height:** 39.75

AH: 23.75 **SH:** 20.75 **SD:** 18 **IW:** 22 **Recl D:** 67 **TV Recl:** 57 **Wall Clr:** 12

Weight: 99 lbs **Cube:** 24.09

Standard Pillows: N/A **Finish Req:** N

Standard Cushions: Repose **Standard Finish:** Brushed Nickel

COM: 7.25 yards **COL:** 130 square feet

Metal Prong Base in Brushed Nickel

D	E	F	G	H	J	K COM	L	M	N	O	P	Q	R	S	T	U	(# above U) *	S Nail	M Nail
4200	4224	4248	4272	4296	4320	4344	4368	4392	4416	4440	4464	4488	4512	4536	4560	4584	24 (Riser) + 4584 (U)	N/A	N/A
Leather 1 5850		Leather 2 6045		Leather 3 6240		Leather 4 6435		Leather 5 6630		Leather 6 6825		Leather 8 8610		COL 4392		S Nail N/A		M Nail N/A	

Upholstery

**Pillows are not available on leather SKUs*

Fabric SKU: **466C-MR** Leather SKU: **L-466C-MR**
 RECLINATION
Wyndham Manual Push Back Recliner

Standard Pillows: N/A **Finish Req:** Y
Standard Cushions: High Resiliency 20 **Standard Finish:**
COM: 3.75 yards **COL:** 79 square feet

Width: 28.25 **Depth:** 33.75 **Height:** 41
AH: 26 **SH:** 18.5 **SD:** 22 **IW:** 24 **Recl D:** 65 **TV Recl:** 57 **Wall Clr:** 18
Weight: 69 lbs **Cube:** 41.32

D	E	F	G	H	J	K COM	L	M	N	O	P	Q	R	S	T	U	(# above U) *	S Nail	M Nail
3000	3012	3024	3036	3048	3060	3072	3084	3096	3108	3120	3132	3144	3156	3168	3180	3192	12 (Riser) + 3192 (U)	N/A	N/A
Leather 1 4050		Leather 2 4170		Leather 3 4290		Leather 4 4410		Leather 5 4530		Leather 6 4650		Leather 8 5745		COL 3096		S Nail N/A		M Nail N/A	

Fabric SKU: **467C-MR** Leather SKU: **L-467C-MR**
 LIBBY LANGDON FOR FAIRFIELD, RECLINATION
Halsey Grande Manual Push Back Recliner

Standard Pillows: N/A **Finish Req:** Y
Standard Cushions: High Resiliency 20 **Standard Finish:**
COM: 7.5 yards **COL:** 135 square feet

Width: 29.75 **Depth:** 35 **Height:** 42.75
AH: 26 **SH:** 20.5 **SD:** 19.5 **IW:** 22.5 **Recl D:** 66 **TV Recl:** 58 **Wall Clr:** 16
Weight: 88 lbs **Cube:** 34.38

D	E	F	G	H	J	K COM	L	M	N	O	P	Q	R	S	T	U	(# above U) *	S Nail	M Nail
3675	3696	3717	3738	3759	3780	3801	3822	3843	3864	3885	3906	3927	3948	3969	3990	4011	21 (Riser) + 4011 (U)	60	N/A
Leather 1 5175		Leather 2 5385		Leather 3 5595		Leather 4 5805		Leather 5 6015		Leather 6 6225		Leather 8 8085		COL 3843		S Nail 60		M Nail N/A	

Fabric SKU: **467C-PR** Leather SKU: **L-467C-PR**
 LIBBY LANGDON FOR FAIRFIELD, RECLINATION
Halsey Grande Power Recliner
 Outside Power Switch

Standard Pillows: N/A **Finish Req:** Y
Standard Cushions: High Resiliency 20 **Standard Finish:**
COM: 7.5 yards **COL:** 135 square feet

Width: 29.75 **Depth:** 35 **Height:** 42.75
AH: 26 **SH:** 20.5 **SD:** 19.5 **IW:** 22.5 **Recl D:** 66 **TV Recl:** 58 **Wall Clr:** 16
Weight: 88 lbs **Cube:** 43.25

D	E	F	G	H	J	K COM	L	M	N	O	P	Q	R	S	T	U	(# above U) *	S Nail	M Nail
4125	4146	4167	4188	4209	4230	4251	4272	4293	4314	4335	4356	4377	4398	4419	4440	4461	21 (Riser) + 4461 (U)	60	N/A
Leather 1 5625		Leather 2 5835		Leather 3 6045		Leather 4 6255		Leather 5 6465		Leather 6 6675		Leather 8 8535		COL 4293		S Nail 60		M Nail N/A	

Fabric SKU: **468C-MR** Leather SKU: **L-468C-MR**
 RECLINATION
Ansleigh Manual Push Back Recliner

Standard Pillows: N/A **Finish Req:** Y
Standard Cushions: High Resiliency 20 **Standard Finish:**
COM: 3.75 yards **COL:** 74 square feet

Width: 28.25 **Depth:** 33.75 **Height:** 41
AH: 26 **SH:** 18.5 **SD:** 22 **IW:** 24 **Recl D:** 65 **TV Recl:** 57 **Wall Clr:** 18
Weight: 69 lbs **Cube:** 43.25

D	E	F	G	H	J	K COM	L	M	N	O	P	Q	R	S	T	U	(# above U) *	S Nail	M Nail
3000	3012	3024	3036	3048	3060	3072	3084	3096	3108	3120	3132	3144	3156	3168	3180	3192	12 (Riser) + 3192 (U)	N/A	N/A
Leather 1 3975		Leather 2 4095		Leather 3 4215		Leather 4 4335		Leather 5 4455		Leather 6 4575		Leather 8 5595		COL 3096		S Nail N/A		M Nail N/A	

Fabric SKU: **469C-MR** Leather SKU: **L-469C-MR**
 LIBBY LANGDON FOR FAIRFIELD, RECLINATION
Halsey Manual Push Back Recliner

Standard Pillows: N/A **Finish Req:** Y
Standard Cushions: High Resiliency 20 **Standard Finish:**
COM: 7.25 yards **COL:** 124 square feet

Width: 29.75 **Depth:** 35 **Height:** 39.75
AH: 26 **SH:** 20.5 **SD:** 19.5 **IW:** 22.5 **Recl D:** 66 **TV Recl:** 58 **Wall Clr:** 16
Weight: 88 lbs **Cube:** 34.38

D	E	F	G	H	J	K COM	L	M	N	O	P	Q	R	S	T	U	(# above U) *	S Nail	M Nail
3600	3621	3642	3663	3684	3705	3726	3747	3768	3789	3810	3831	3852	3873	3894	3915	3936	21 (Riser) + 3936 (U)	60	N/A
Leather 1 5025		Leather 2 5220		Leather 3 5415		Leather 4 5610		Leather 5 5805		Leather 6 6000		Leather 8 7710		COL 3768		S Nail 60		M Nail N/A	

Fabric SKU: **469C-PR** Leather SKU: **L-469C-PR**
 LIBBY LANGDON FOR FAIRFIELD, RECLINATION
Halsey Power Recliner

Standard Pillows: N/A **Finish Req:** Y
Standard Cushions: High Resiliency 20 **Standard Finish:**
COM: 7.25 yards **COL:** 124 square feet

Width: 29.75 **Depth:** 35 **Height:** 39.75
AH: 26 **SH:** 20.5 **SD:** 19.5 **IW:** 22.5 **Recl D:** 66 **TV Recl:** 58 **Wall Clr:** 16
Weight: 88 lbs **Cube:** 41.32

D	E	F	G	H	J	K COM	L	M	N	O	P	Q	R	S	T	U	(# above U) *	S Nail	M Nail
4050	4071	4092	4113	4134	4155	4176	4197	4218	4239	4260	4281	4302	4323	4344	4365	4386	21 (Riser) + 4386 (U)	60	N/A
Leather 1 5475		Leather 2 5670		Leather 3 5865		Leather 4 6060		Leather 5 6255		Leather 6 6450		Leather 8 8160		COL 4218		S Nail 60		M Nail N/A	

Upholstery

**Pillows are not available on leather SKUs*

Fabric SKU: **470C-MR-2**

Leather SKU: **L-470C-MR-2**

RECLINATION

Infinity Manual Push Back Recliner

Brushed Nickel

Width: 28.25 **Depth:** 33.75 **Height:** 41

AH: 26 **SH:** 18.5 **SD:** 22 **IW:** 24 **Recl D:** 65 **TV Recl:** 57 **Wall Clr:** 18

Weight: 69 lbs **Cube:** 34.38

Standard Pillows: N/A **Finish Req:** N

Standard Cushions: High Resiliency 20 **Standard Finish:** Brushed Nickel

COM: 3.75 yards **COL:** 79 square feet

Metal Base in Nickel

D	E	F	G	H	J	K COM	L	M	N	O	P	Q	R	S	T	U	(# above U) *	S Nail	M Nail
3375	3387	3399	3411	3423	3435	3447	3459	3471	3483	3495	3507	3519	3531	3543	3555	3567	12 (Riser) + 3567 (U)	N/A	N/A
Leather 1 4575		Leather 2 4695		Leather 3 4815		Leather 4 4935		Leather 5 5055		Leather 6 5175		Leather 8 6270		COL 3471		S Nail N/A		M Nail N/A	

Fabric SKU: **470C-MR-6**

Leather SKU: **L-470C-MR-6**

RECLINATION

Infinity Manual Push Back Recliner

Brushed Brass

Width: 28.25 **Depth:** 33.75 **Height:** 41

AH: 26 **SH:** 18.5 **SD:** 22 **IW:** 24 **Recl D:** 65 **TV Recl:** 57 **Wall Clr:** 18

Weight: 69 lbs **Cube:** 43.25

Standard Pillows: N/A **Finish Req:** N

Standard Cushions: High Resiliency 20 **Standard Finish:** Brushed Brass

COM: 3.75 yards **COL:** 79 square feet

Metal Base in Brushed Brass

D	E	F	G	H	J	K COM	L	M	N	O	P	Q	R	S	T	U	(# above U) *	S Nail	M Nail
3375	3387	3399	3411	3423	3435	3447	3459	3471	3483	3495	3507	3519	3531	3543	3555	3567	12 (Riser) + 3567 (U)	N/A	N/A
Leather 1 4575		Leather 2 4695		Leather 3 4815		Leather 4 4935		Leather 5 5055		Leather 6 5175		Leather 8 6270		COL 3471		S Nail N/A		M Nail N/A	

Fabric SKU: **471C-MR**

Leather SKU: **L-471C-MR**

RECLINATION

Bridgett Manual Push Back Recliner

Width: 27 **Depth:** 33 **Height:** 43.5

AH: 26 **SH:** 19 **SD:** 20 **IW:** 21.5 **Recl D:** 64 **TV Recl:** 55 **Wall Clr:** 19.75

Weight: 90 lbs **Cube:** 43.25

Standard Pillows: N/A **Finish Req:** Y

Standard Cushions: High Resiliency 35 **Standard Finish:**

COM: 3.5 yards **COL:** 68 square feet

D	E	F	G	H	J	K COM	L	M	N	O	P	Q	R	S	T	U	(# above U) *	S Nail	M Nail
2700	2712	2724	2736	2748	2760	2772	2784	2796	2808	2820	2832	2844	2856	2868	2880	2892	12 (Riser) + 2892 (U)	N/A	N/A
Leather 1 3600		Leather 2 3705		Leather 3 3810		Leather 4 3915		Leather 5 4020		Leather 6 4125		Leather 8 5070		COL 2796		S Nail N/A		M Nail N/A	

Fabric SKU: **476C-MR**

Leather SKU: **L-476C-MR**

RECLINATION

Harrisburg Manual Push Back Recliner

Width: 32.25 **Depth:** 37.25 **Height:** 43.5

AH: 26.5 **SH:** 20 **SD:** 18 **IW:** 22 **Recl D:** 68 **TV Recl:** 59.25 **Wall Clr:** 18

Weight: 88 lbs **Cube:** 34.38

Standard Pillows: N/A **Finish Req:** Y

Standard Cushions: High Resiliency 20 **Standard Finish:**

COM: 8.25 yards **COL:** 147 square feet

D	E	F	G	H	J	K COM	L	M	N	O	P	Q	R	S	T	U	(# above U) *	S Nail	M Nail
3600	3624	3648	3672	3696	3720	3744	3768	3792	3816	3840	3864	3888	3912	3936	3960	3984	24 (Riser) + 3984 (U)	N/A	N/A
Leather 1 5250		Leather 2 5475		Leather 3 5700		Leather 4 5925		Leather 5 6150		Leather 6 6375		Leather 8 8400		COL 3792		S Nail N/A		M Nail N/A	

Fabric SKU: **B077-01**

Leather SKU: **L-B077-01**

Sparta Lounge Chair

Width: 30.5 **Depth:** 34.5 **Height:** 32

AH: 22 **SH:** 18 **SD:** 21 **IW:** 24

Weight: 60 lbs **Cube:** 29.69

Standard Pillows: N/A **Finish Req:** N

Standard Cushions: High Resiliency 40 **Standard Finish:** Bronze

COM: 5.5 yards **COL:** 79 square feet

Only available in Bronze finish

D	E	F	G	H	J	K COM	L	M	N	O	P	Q	R	S	T	U	(# above U) *	S Nail	M Nail
2325	2340	2355	2370	2385	2400	2415	2430	2445	2460	2475	2490	2505	2520	2535	2550	2565	15 (Riser) + 2565 (U)	N/A	N/A
Leather 1 3345		Leather 2 3465		Leather 3 3585		Leather 4 3705		Leather 5 3825		Leather 6 3945		Leather 8 5040		COL 2445		S Nail N/A		M Nail N/A	

Fabric SKU: **B078-01**

Leather SKU: **L-B078-01**

Sparta Lounge Chair

Width: 30.5 **Depth:** 34.5 **Height:** 32

AH: 22 **SH:** 18 **SD:** 21 **IW:** 24

Weight: 60 lbs **Cube:** 29.69

Standard Pillows: N/A **Finish Req:** N

Standard Cushions: High Resiliency 40 **Standard Finish:** Bronze

COM: 5.25 yards **COL:** 79 square feet

Only available in Bronze finish

D	E	F	G	H	J	K COM	L	M	N	O	P	Q	R	S	T	U	(# above U) *	S Nail	M Nail
2340	2355	2370	2385	2400	2415	2430	2445	2460	2475	2490	2505	2520	2535	2550	2565	2580	15 (Riser) + 2580 (U)	N/A	N/A
Leather 1 3285		Leather 2 3405		Leather 3 3525		Leather 4 3645		Leather 5 3765		Leather 6 3885		Leather 8 4980		COL 2460		S Nail N/A		M Nail N/A	

Upholstery

**Pillows are not available on leather SKUs*

Fabric SKU: **B091-01**

Leather SKU: **L-B091-01**

Standard Pillows: N/A **Finish Req:** N

Standard Cushions: High Resiliency 40 **Standard Finish:** Bronze

COM: 2.75 yards **COL:** 51 square feet

Only available in Bronze finish

Nolita Occasional Chair

Width: 28 **Depth:** 24.5 **Height:** 28

AH: 28 **SH:** 19 **SD:** 19 **IW:** 18

Weight: 32 lbs **Cube:** 21.65

D	E	F	G	H	J	K COM	L	M	N	O	P	Q	R	S	T	U	(# above U) *	S Nail	M Nail
1815	1827	1839	1851	1863	1875	1887	1899	1911	1923	1935	1947	1959	1971	1983	1995	2007	12 (Riser) + 2007 (U)	N/A	N/A
Leather 1 2445		Leather 2 2520		Leather 3 2595		Leather 4 2670		Leather 5 2745		Leather 6 2820		Leather 8 3525		COL 1911		S Nail N/A		M Nail N/A	

Fabric SKU: **B091-06**

Leather SKU: **L-B091-06**

Standard Pillows: N/A **Finish Req:** N

Standard Cushions: High Resiliency 40 **Standard Finish:** Bronze

COM: 2.75 yards **COL:** 48.6 square feet

Only available in Bronze finish

Nolita Bar Stool

Width: 28 **Depth:** 24.5 **Height:** 39.5

AH: 39.5 **SH:** 30 **SD:** 19 **IW:** 18

Weight: 34 lbs **Cube:** 21.65

D	E	F	G	H	J	K COM	L	M	N	O	P	Q	R	S	T	U	(# above U) *	S Nail	M Nail
1890	1902	1914	1926	1938	1950	1962	1974	1986	1998	2010	2022	2034	2046	2058	2070	2082	12 (Riser) + 2082 (U)	N/A	N/A
Leather 1 2550		Leather 2 2625		Leather 3 2700		Leather 4 2775		Leather 5 2850		Leather 6 2925		Leather 8 3600		COL 1986		S Nail N/A		M Nail N/A	

Fabric SKU: **B091-C6**

Leather SKU: **L-B091-C6**

Standard Pillows: N/A **Finish Req:** N

Standard Cushions: High Resiliency 40 **Standard Finish:** Bronze

COM: 2.75 yards **COL:** 48.6 square feet

Only available in Bronze finish

Nolita Counter Stool

Width: 28 **Depth:** 24.5 **Height:** 35.5

AH: 35.5 **SH:** 26 **SD:** 19 **IW:** 18

Weight: 34 lbs **Cube:** 21.65

D	E	F	G	H	J	K COM	L	M	N	O	P	Q	R	S	T	U	(# above U) *	S Nail	M Nail
1890	1902	1914	1926	1938	1950	1962	1974	1986	1998	2010	2022	2034	2046	2058	2070	2082	12 (Riser) + 2082 (U)	N/A	N/A
Leather 1 2550		Leather 2 2625		Leather 3 2700		Leather 4 2775		Leather 5 2850		Leather 6 2925		Leather 8 3600		COL 1986		S Nail N/A		M Nail N/A	

Fabric SKU: **B098-05**

Leather SKU: **L-B098-05**

Standard Pillows: N/A **Finish Req:** N

Standard Cushions: High Resiliency 40 **Standard Finish:** Bronze

COM: 1.75 yards **COL:** 28.8 square feet

Only available in Bronze finish

Ian Side Chair

Width: 21 **Depth:** 26 **Height:** 35.5

AH: 0 **SH:** 20.5 **SD:** 19.5 **IW:** 21

Weight: 23 lbs **Cube:** 21.65

D	E	F	G	H	J	K COM	L	M	N	O	P	Q	R	S	T	U	(# above U) *	S Nail	M Nail
1545	1551	1557	1563	1569	1575	1581	1587	1593	1599	1605	1611	1617	1623	1629	1635	1641	6 (Riser) + 1641 (U)	N/A	N/A
Leather 1 1950		Leather 2 1995		Leather 3 2040		Leather 4 2085		Leather 5 2130		Leather 6 2175		Leather 8 2580		COL 1593		S Nail N/A		M Nail N/A	

Fabric SKU: **B098-07**

Leather SKU: **L-B098-07**

Standard Pillows: N/A **Finish Req:** N

Standard Cushions: High Resiliency 40 **Standard Finish:** Bronze

COM: 1.75 yards **COL:** 28.8 square feet

Only available in Bronze finish

Ian Bar Stool

Width: 21 **Depth:** 26 **Height:** 45

AH: 0 **SH:** 30 **SD:** 19.5 **IW:** 21

Weight: 25 lbs **Cube:** 24.14

D	E	F	G	H	J	K COM	L	M	N	O	P	Q	R	S	T	U	(# above U) *	S Nail	M Nail
1590	1596	1602	1608	1614	1620	1626	1632	1638	1644	1650	1656	1662	1668	1674	1680	1686	6 (Riser) + 1686 (U)	N/A	N/A
Leather 1 1995		Leather 2 2040		Leather 3 2085		Leather 4 2130		Leather 5 2175		Leather 6 2220		Leather 8 2625		COL 1638		S Nail N/A		M Nail N/A	

Fabric SKU: **B098-C7**

Leather SKU: **L-B098-C7**

Standard Pillows: N/A **Finish Req:** N

Standard Cushions: High Resiliency 40 **Standard Finish:** Bronze

COM: 1.75 yards **COL:** 28.8 square feet

Only available in Bronze finish

Ian Counter Stool

Width: 21 **Depth:** 26 **Height:** 41

AH: 0 **SH:** 26 **SD:** 19.5 **IW:** 21

Weight: 23 lbs **Cube:** 21.65

D	E	F	G	H	J	K COM	L	M	N	O	P	Q	R	S	T	U	(# above U) *	S Nail	M Nail
1590	1596	1602	1608	1614	1620	1626	1632	1638	1644	1650	1656	1662	1668	1674	1680	1686	6 (Riser) + 1686 (U)	N/A	N/A
Leather 1 1995		Leather 2 2040		Leather 3 2085		Leather 4 2130		Leather 5 2175		Leather 6 2220		Leather 8 2625		COL 1638		S Nail N/A		M Nail N/A	

Upholstery

**Pillows are not available on leather SKUs*

Fabric SKU: **B099-05**

Leather SKU: **L-B099-05**

Standard Pillows: N/A **Finish Req:** N

Standard Cushions: High Resiliency 55 **Standard Finish:** Bronze

COM: 1.75 yards **COL:** 28.8 square feet

Only available in Bronze finish

Uma Side Chair

Width: 21 **Depth:** 26 **Height:** 35.5

AH: 0 **SH:** 20.5 **SD:** 19.5 **IW:** 21

Weight: 23 lbs **Cube:** 21.65

D	E	F	G	H	J	K COM	L	M	N	O	P	Q	R	S	T	U	(# above U) *	S Nail	M Nail
1605	1611	1617	1623	1629	1635	1641	1647	1653	1659	1665	1671	1677	1683	1689	1695	1701	6 (Riser) + 1701 (U)	N/A	N/A
Leather 1 2040		Leather 2 2085		Leather 3 2130		Leather 4 2175		Leather 5 2220		Leather 6 2265		Leather 8 2670		COL 1653		S Nail N/A		M Nail N/A	

Fabric SKU: **B099-07**

Leather SKU: **L-B099-07**

Standard Pillows: N/A **Finish Req:** N

Standard Cushions: High Resiliency 55 **Standard Finish:** Bronze

COM: 1.75 yards **COL:** 28.8 square feet

Only available in Bronze finish

Uma Bar Stool

Width: 21 **Depth:** 26 **Height:** 45

AH: 0 **SH:** 30 **SD:** 19.5 **IW:** 21

Weight: 25 lbs **Cube:** 24.14

D	E	F	G	H	J	K COM	L	M	N	O	P	Q	R	S	T	U	(# above U) *	S Nail	M Nail
1665	1671	1677	1683	1689	1695	1701	1707	1713	1719	1725	1731	1737	1743	1749	1755	1761	6 (Riser) + 1761 (U)	N/A	N/A
Leather 1 2115		Leather 2 2160		Leather 3 2205		Leather 4 2250		Leather 5 2295		Leather 6 2340		Leather 8 2745		COL 1713		S Nail N/A		M Nail N/A	

Fabric SKU: **B099-C7**

Leather SKU: **L-B099-C7**

Standard Pillows: N/A **Finish Req:** N

Standard Cushions: High Resiliency 55 **Standard Finish:** Bronze

COM: 1.75 yards **COL:** 28.8 square feet

Only available in Bronze finish

Uma Counter Stool

Width: 21 **Depth:** 26 **Height:** 41

AH: 0 **SH:** 26 **SD:** 19.5 **IW:** 21

Weight: 23 lbs **Cube:** 21.65

D	E	F	G	H	J	K COM	L	M	N	O	P	Q	R	S	T	U	(# above U) *	S Nail	M Nail
1665	1671	1677	1683	1689	1695	1701	1707	1713	1719	1725	1731	1737	1743	1749	1755	1761	6 (Riser) + 1761 (U)	N/A	N/A
Leather 1 2115		Leather 2 2160		Leather 3 2205		Leather 4 2250		Leather 5 2295		Leather 6 2340		Leather 8 2745		COL 1713		S Nail N/A		M Nail N/A	

Fabric SKU: **B100-05**

Leather SKU: **L-B100-05**

Standard Pillows: N/A **Finish Req:** N

Standard Cushions: High Resiliency 40 **Standard Finish:** Bright Brass

COM: 1.75 yards **COL:** 28.8 square feet

Only available in Bright Brass finish

Ian Side Chair

Width: 21 **Depth:** 26 **Height:** 35.5

AH: 0 **SH:** 20.5 **SD:** 19.5 **IW:** 21

Weight: 23 lbs **Cube:** 21.65

D	E	F	G	H	J	K COM	L	M	N	O	P	Q	R	S	T	U	(# above U) *	S Nail	M Nail
1530	1536	1542	1548	1554	1560	1566	1572	1578	1584	1590	1596	1602	1608	1614	1620	1626	6 (Riser) + 1626 (U)	N/A	N/A
Leather 1 1965		Leather 2 2010		Leather 3 2055		Leather 4 2100		Leather 5 2145		Leather 6 2190		Leather 8 2595		COL 1578		S Nail N/A		M Nail N/A	

Fabric SKU: **B100-C7**

Leather SKU: **L-B100-C7**

Standard Pillows: N/A **Finish Req:** N

Standard Cushions: High Resiliency 40 **Standard Finish:** Bright Brass

COM: 1.75 yards **COL:** 28.8 square feet

Only available in Bright Brass finish

Ian Counter Stool

Width: 21 **Depth:** 26 **Height:** 41

AH: 0 **SH:** 26 **SD:** 19.5 **IW:** 21

Weight: 23 lbs **Cube:** 21.65

D	E	F	G	H	J	K COM	L	M	N	O	P	Q	R	S	T	U	(# above U) *	S Nail	M Nail
1605	1611	1617	1623	1629	1635	1641	1647	1653	1659	1665	1671	1677	1683	1689	1695	1701	6 (Riser) + 1701 (U)	N/A	N/A
Leather 1 2010		Leather 2 2055		Leather 3 2100		Leather 4 2145		Leather 5 2190		Leather 6 2235		Leather 8 2640		COL 1653		S Nail N/A		M Nail N/A	

Fabric SKU: **B101-05**

Leather SKU: **L-B101-05**

Standard Pillows: N/A **Finish Req:** N

Standard Cushions: High Resiliency 55 **Standard Finish:** Bright Brass

COM: 1.75 yards **COL:** 28.8 square feet

Only available in Bright Brass finish

Uma Side Chair

Width: 21 **Depth:** 26 **Height:** 35.5

AH: 0 **SH:** 20.5 **SD:** 19.5 **IW:** 21

Weight: 23 lbs **Cube:** 21.65

D	E	F	G	H	J	K COM	L	M	N	O	P	Q	R	S	T	U	(# above U) *	S Nail	M Nail
1605	1611	1617	1623	1629	1635	1641	1647	1653	1659	1665	1671	1677	1683	1689	1695	1701	6 (Riser) + 1701 (U)	N/A	N/A
Leather 1 2040		Leather 2 2085		Leather 3 2130		Leather 4 2175		Leather 5 2220		Leather 6 2265		Leather 8 2670		COL 1653		S Nail N/A		M Nail N/A	

Upholstery

**Pillows are not available on leather SKUs*

Fabric SKU: **B101-C7**

Leather SKU: **L-B101-C7**

Standard Pillows: N/A Finish Req: N

Standard Cushions: High Resiliency 55 Standard Finish: Bright Brass

COM: 1.75 yards COL: 28.8 square feet

Only available in Bright Brass finish

Uma Counter Stool

Width: 21 Depth: 26 Height: 41

AH: 0 SH: 26 SD: 19.5 IW: 21

Weight: 23 lbs Cube: 19.6

D	E	F	G	H	J	K COM	L	M	N	O	P	Q	R	S	T	U	(# above U) *	S Nail	M Nail
1650	1656	1662	1668	1674	1680	1686	1692	1698	1704	1710	1716	1722	1728	1734	1740	1746	6 (Riser) + 1746 (U)	N/A	N/A
Leather 1 2085		Leather 2 2130		Leather 3 2175		Leather 4 2220		Leather 5 2265		Leather 6 2310		Leather 8 2715		COL 1698		S Nail N/A		M Nail N/A	

Fabric SKU: **BAT1-PK**

Leather SKU: **N/A**

Standard Pillows: N/A Finish Req: N

Standard Cushions: N/A Standard Finish:

COM: N/A yards COL: N/A

Use with -PR Power Recliners.

RECLINATION

Battery Pack

Width: 4 Depth: 6 Height: 3

AH: 0 SH: 0 SD: 0 IW: 0

Weight: 3 lbs Cube: 0.1

D	E	F	G	H	J	K COM	L	M	N	O	P	Q	R	S	T	U	(# above U) *	S Nail	M Nail
450	450	450	450	450	450	450	450	450	450	450	450	450	450	450	450	450	N/A (Riser) + 450 (U)	N/A	N/A
Leather 1 N/A		Leather 2 N/A		Leather 3 N/A		Leather 4 N/A		Leather 5 N/A		Leather 6 N/A		Leather 8 N/A		COL N/A		S Nail N/A		M Nail N/A	

Fabric SKU: **BAT2-PK**

Leather SKU: **N/A**

Standard Pillows: N/A Finish Req: N

Standard Cushions: N/A Standard Finish:

COM: N/A yards COL: N/A

Use with -PL Power Lift + Recline Recliners.

RECLINATION

Battery Pack

Width: 0 Depth: 0 Height: 0

AH: 0 SH: 0 SD: 0 IW: 0

Weight: 3 lbs Cube: 0

D	E	F	G	H	J	K COM	L	M	N	O	P	Q	R	S	T	U	(# above U) *	S Nail	M Nail
735	735	735	735	735	735	735	735	735	735	735	735	735	735	735	735	735	N/A (Riser) + 735 (U)	N/A	N/A
Leather 1 N/A		Leather 2 N/A		Leather 3 N/A		Leather 4 N/A		Leather 5 N/A		Leather 6 N/A		Leather 8 N/A		COL N/A		S Nail N/A		M Nail N/A	

Fabric SKU: **F000-07-K**

Leather SKU: **N/A**

Standard Pillows: N/A Finish Req: N

Standard Cushions: N/A Standard Finish: Matte Black

COM: N/A yards COL: N/A

Married in 1310-60 Black leather with decorative stitching on seat. Metal base.

THE LEATHER RESERVE

Nico Bar Stool

Width: 18 Depth: 19.5 Height: 30

AH: 0 SH: 0 SD: 0 IW: 0

Weight: 13 lbs Cube: 6.09

D	E	F	G	H	J	K COM	L	M	N	O	P	Q	R	S	T	U	(# above U) *	S Nail	M Nail
597	N/A	N/A	N/A	N/A	N/A	N/A	N/A	N/A	N/A	N/A	N/A	N/A	N/A	N/A	N/A	N/A	N/A (Riser) + N/A (U)	N/A	N/A
Leather 1 N/A		Leather 2 N/A		Leather 3 N/A		Leather 4 N/A		Leather 5 N/A		Leather 6 N/A		Leather 8 N/A		COL N/A		S Nail N/A		M Nail N/A	

Fabric SKU: **F000-07-N**

Leather SKU: **N/A**

Standard Pillows: N/A Finish Req: N

Standard Cushions: N/A Standard Finish: Matte Black

COM: N/A yards COL: N/A

Married in 1309-10 Brown leather with decorative stitching on seat. Metal base.

THE LEATHER RESERVE

Nico Bar Stool

Width: 18 Depth: 19.5 Height: 30

AH: 0 SH: 0 SD: 0 IW: 0

Weight: 13 lbs Cube: 6.09

D	E	F	G	H	J	K COM	L	M	N	O	P	Q	R	S	T	U	(# above U) *	S Nail	M Nail
597	N/A	N/A	N/A	N/A	N/A	N/A	N/A	N/A	N/A	N/A	N/A	N/A	N/A	N/A	N/A	N/A	N/A (Riser) + N/A (U)	N/A	N/A
Leather 1 N/A		Leather 2 N/A		Leather 3 N/A		Leather 4 N/A		Leather 5 N/A		Leather 6 N/A		Leather 8 N/A		COL N/A		S Nail N/A		M Nail N/A	

Fabric SKU: **F000-C7-K**

Leather SKU: **N/A**

Standard Pillows: N/A Finish Req: N

Standard Cushions: N/A Standard Finish: Matte Black

COM: N/A yards COL: N/A

Married in 1310-60 Black leather with decorative stitching on seat. Metal base.

THE LEATHER RESERVE

Nico Counter Stool

Width: 19 Depth: 19 Height: 26.5

AH: 0 SH: 24.25 SD: 18.75 IW: 19

Weight: 12 lbs Cube: 5.53

D	E	F	G	H	J	K COM	L	M	N	O	P	Q	R	S	T	U	(# above U) *	S Nail	M Nail
597	N/A	N/A	N/A	N/A	N/A	N/A	N/A	N/A	N/A	N/A	N/A	N/A	N/A	N/A	N/A	N/A	N/A (Riser) + N/A (U)	N/A	N/A
Leather 1 N/A		Leather 2 N/A		Leather 3 N/A		Leather 4 N/A		Leather 5 N/A		Leather 6 N/A		Leather 8 N/A		COL N/A		S Nail N/A		M Nail N/A	

Upholstery

**Pillows are not available on leather SKUs*

Fabric SKU: **F000-C7-N**
THE LEATHER RESERVE
Nico Counter Stool

Leather SKU: **N/A**

Standard Pillows: N/A Finish Req: N
Standard Cushions: N/A Standard Finish: Matte Black
COM: N/A yards COL: N/A
Married in 1309-10 Brown leather with decorative stitching on seat. Metal base.

Width: 19 Depth: 19 Height: 26.5
AH: 0 SH: 24.25 SD: 18.75 IW: 19
Weight: 12 lbs Cube: 5.53

D	E	F	G	H	J	K COM	L	M	N	O	P	Q	R	S	T	U	(# above U) *	S Nail	M Nail
597	N/A	N/A	N/A	N/A	N/A	N/A	N/A	N/A	N/A	N/A	N/A	N/A	N/A	N/A	N/A	N/A	N/A (Riser) + N/A (U)	N/A	N/A
Leather 1 N/A		Leather 2 N/A		Leather 3 N/A		Leather 4 N/A		Leather 5 N/A		Leather 6 N/A		Leather 8 N/A		COL N/A		S Nail N/A		M Nail N/A	

Fabric SKU: **F001-07-K**
THE LEATHER RESERVE
Nadia Bar Stool

Leather SKU: **N/A**

Standard Pillows: N/A Finish Req: N
Standard Cushions: N/A Standard Finish: Matte Black
COM: N/A yards COL: N/A
Married in 1310-60 Black leather with decorative stitching on seat. Metal base.

Width: 19.5 Depth: 20.5 Height: 43
AH: 0 SH: 30.5 SD: 17 IW: 19.5
Weight: 17 lbs Cube: 9.94

D	E	F	G	H	J	K COM	L	M	N	O	P	Q	R	S	T	U	(# above U) *	S Nail	M Nail
837	N/A	N/A	N/A	N/A	N/A	N/A	N/A	N/A	N/A	N/A	N/A	N/A	N/A	N/A	N/A	N/A	N/A (Riser) + N/A (U)	N/A	N/A
Leather 1 N/A		Leather 2 N/A		Leather 3 N/A		Leather 4 N/A		Leather 5 N/A		Leather 6 N/A		Leather 8 N/A		COL N/A		S Nail N/A		M Nail N/A	

Fabric SKU: **F001-07-N**
THE LEATHER RESERVE
Nadia Bar Stool

Leather SKU: **N/A**

Standard Pillows: N/A Finish Req: N
Standard Cushions: N/A Standard Finish: Matte Black
COM: N/A yards COL: N/A
Married in 1309-10 Brown leather with decorative stitching on seat. Metal base.

Width: 19.5 Depth: 20.5 Height: 43
AH: 0 SH: 30.5 SD: 17 IW: 19.5
Weight: 17 lbs Cube: 9.94

D	E	F	G	H	J	K COM	L	M	N	O	P	Q	R	S	T	U	(# above U) *	S Nail	M Nail
837	N/A	N/A	N/A	N/A	N/A	N/A	N/A	N/A	N/A	N/A	N/A	N/A	N/A	N/A	N/A	N/A	N/A (Riser) + N/A (U)	N/A	N/A
Leather 1 N/A		Leather 2 N/A		Leather 3 N/A		Leather 4 N/A		Leather 5 N/A		Leather 6 N/A		Leather 8 N/A		COL N/A		S Nail N/A		M Nail N/A	

Fabric SKU: **F001-C7-K**
THE LEATHER RESERVE
Nadia Counter Stool

Leather SKU: **N/A**

Standard Pillows: N/A Finish Req: N
Standard Cushions: N/A Standard Finish: Matte Black
COM: N/A yards COL: N/A
Married in 1310-60 Black leather with decorative stitching on seat. Metal base.

Width: 19.5 Depth: 20.5 Height: 37
AH: 0 SH: 24.5 SD: 17 IW: 19.5
Weight: 16 lbs Cube: 8.55

D	E	F	G	H	J	K COM	L	M	N	O	P	Q	R	S	T	U	(# above U) *	S Nail	M Nail
837	N/A	N/A	N/A	N/A	N/A	N/A	N/A	N/A	N/A	N/A	N/A	N/A	N/A	N/A	N/A	N/A	N/A (Riser) + N/A (U)	N/A	N/A
Leather 1 N/A		Leather 2 N/A		Leather 3 N/A		Leather 4 N/A		Leather 5 N/A		Leather 6 N/A		Leather 8 N/A		COL N/A		S Nail N/A		M Nail N/A	

Fabric SKU: **F001-C7-N**
THE LEATHER RESERVE
Nadia Counter Stool

Leather SKU: **N/A**

Standard Pillows: N/A Finish Req: N
Standard Cushions: N/A Standard Finish: Matte Black
COM: N/A yards COL: N/A
Married in 1309-10 Brown leather with decorative stitching on seat. Metal base.

Width: 19.5 Depth: 20.5 Height: 37
AH: 0 SH: 24.5 SD: 17 IW: 19.5
Weight: 16 lbs Cube: 8.55

D	E	F	G	H	J	K COM	L	M	N	O	P	Q	R	S	T	U	(# above U) *	S Nail	M Nail
837	N/A	N/A	N/A	N/A	N/A	N/A	N/A	N/A	N/A	N/A	N/A	N/A	N/A	N/A	N/A	N/A	N/A (Riser) + N/A (U)	N/A	N/A
Leather 1 N/A		Leather 2 N/A		Leather 3 N/A		Leather 4 N/A		Leather 5 N/A		Leather 6 N/A		Leather 8 N/A		COL N/A		S Nail N/A		M Nail N/A	

Fabric SKU: **F002-07-K**
THE LEATHER RESERVE
Luca Bar Stool

Leather SKU: **N/A**

Standard Pillows: N/A Finish Req: N
Standard Cushions: N/A Standard Finish: Matte Black
COM: N/A yards COL: N/A
Married in 1310-60 Black leather with channeled upholstered seat. Mango wooden rails and decorative leather sling straps on the seating. Metal base.

Width: 18.75 Depth: 23.5 Height: 42.5
AH: 0 SH: 30 SD: 17 IW: 18.75
Weight: 20 lbs Cube: 10.83

D	E	F	G	H	J	K COM	L	M	N	O	P	Q	R	S	T	U	(# above U) *	S Nail	M Nail
987	N/A	N/A	N/A	N/A	N/A	N/A	N/A	N/A	N/A	N/A	N/A	N/A	N/A	N/A	N/A	N/A	N/A (Riser) + N/A (U)	N/A	N/A
Leather 1 N/A		Leather 2 N/A		Leather 3 N/A		Leather 4 N/A		Leather 5 N/A		Leather 6 N/A		Leather 8 N/A		COL N/A		S Nail N/A		M Nail N/A	

Upholstery

**Pillows are not available on leather SKUs*

Fabric SKU: **F002-07-N** Leather SKU: **N/A**
 THE LEATHER RESERVE
Luca Bar Stool

Standard Pillows: N/A **Finish Req:** N
Standard Cushions: N/A **Standard Finish:** Matte Black
COM: N/A yards **COL:** N/A
 Married in 1309-10 Brown leather with channeled upholstered seat. Mango wooden rails and decorative leather sling straps on the seating. Metal base.

Width: 18.75 **Depth:** 23.5 **Height:** 42.5
AH: 0 **SH:** 30 **SD:** 17 **IW:** 18.75
Weight: 20 lbs **Cube:** 10.83

D	E	F	G	H	J	K ^{COM}	L	M	N	O	P	Q	R	S	T	U	(# above U) *	S Nail	M Nail
987	N/A	N/A	N/A	N/A	N/A	N/A	N/A	N/A	N/A	N/A	N/A	N/A	N/A	N/A	N/A	N/A	N/A (Riser) + N/A (U)	N/A	N/A
Leather 1		Leather 2		Leather 3		Leather 4		Leather 5		Leather 6		Leather 8		COL		S Nail		M Nail	
N/A		N/A		N/A		N/A		N/A		N/A		N/A		N/A		N/A		N/A	

Fabric SKU: **F002-C7-K** Leather SKU: **N/A**
 THE LEATHER RESERVE
Luca Counter Stool

Standard Pillows: N/A **Finish Req:** N
Standard Cushions: N/A **Standard Finish:** Matte Black
COM: N/A yards **COL:** N/A
 Married in 1310-60 Black leather with channeled upholstered seat. Mango wooden rails and decorative leather sling straps on the seating. Metal base.

Width: 18.75 **Depth:** 23.5 **Height:** 39
AH: 0 **SH:** 26 **SD:** 17 **IW:** 18.75
Weight: 19 lbs **Cube:** 9.94

D	E	F	G	H	J	K ^{COM}	L	M	N	O	P	Q	R	S	T	U	(# above U) *	S Nail	M Nail
987	N/A	N/A	N/A	N/A	N/A	N/A	N/A	N/A	N/A	N/A	N/A	N/A	N/A	N/A	N/A	N/A	N/A (Riser) + N/A (U)	N/A	N/A
Leather 1		Leather 2		Leather 3		Leather 4		Leather 5		Leather 6		Leather 8		COL		S Nail		M Nail	
N/A		N/A		N/A		N/A		N/A		N/A		N/A		N/A		N/A		N/A	

Fabric SKU: **F002-C7-N** Leather SKU: **N/A**
 THE LEATHER RESERVE
Luca Counter Stool

Standard Pillows: N/A **Finish Req:** N
Standard Cushions: N/A **Standard Finish:** Matte Black
COM: N/A yards **COL:** N/A
 Married in 1309-10 Brown leather with channeled upholstered seat. Mango wooden rails and decorative leather sling straps on the seating. Metal base.

Width: 18.75 **Depth:** 23.5 **Height:** 39
AH: 0 **SH:** 26 **SD:** 17 **IW:** 18.75
Weight: 19 lbs **Cube:** 9.94

D	E	F	G	H	J	K ^{COM}	L	M	N	O	P	Q	R	S	T	U	(# above U) *	S Nail	M Nail
987	N/A	N/A	N/A	N/A	N/A	N/A	N/A	N/A	N/A	N/A	N/A	N/A	N/A	N/A	N/A	N/A	N/A (Riser) + N/A (U)	N/A	N/A
Leather 1		Leather 2		Leather 3		Leather 4		Leather 5		Leather 6		Leather 8		COL		S Nail		M Nail	
N/A		N/A		N/A		N/A		N/A		N/A		N/A		N/A		N/A		N/A	

Fabric SKU: **F005-31** Leather SKU: **N/A**
 THE LEATHER RESERVE
Iman Swivel Chair

Standard Pillows: N/A **Finish Req:** N
Standard Cushions: Classic Plush **Standard Finish:** Tobacco
COM: N/A yards **COL:** N/A
 Married in 1306 67 Pewter with Brushed Nickel nail trim

Width: 33 **Depth:** 35 **Height:** 30.75
AH: 24 **SH:** 19 **SD:** 22 **IW:** 22
Weight: 88 lbs **Cube:** 20.55

D	E	F	G	H	J	K ^{COM}	L	M	N	O	P	Q	R	S	T	U	(# above U) *	S Nail	M Nail
2397	N/A	N/A	N/A	N/A	N/A	N/A	N/A	N/A	N/A	N/A	N/A	N/A	N/A	N/A	N/A	N/A	N/A (Riser) + N/A (U)	N/A	N/A
Leather 1		Leather 2		Leather 3		Leather 4		Leather 5		Leather 6		Leather 8		COL		S Nail		M Nail	
N/A		N/A		N/A		N/A		N/A		N/A		N/A		N/A		N/A		N/A	

Fabric SKU: **F006-PR-D** Leather SKU: **N/A**
 THE LEATHER RESERVE
Hailey Power Recliner

Standard Pillows: N/A **Finish Req:** N
Standard Cushions: High Resiliency 35 **Standard Finish:**
COM: N/A yards **COL:** N/A
 Married in 1304 90 Denim Leather with Brushed Nickel nail trim.

Power Articulating Headrest, Outside Power Switch
Width: 34.5 **Depth:** 39 **Height:** 42
AH: 24 **SH:** 20 **SD:** 20 **IW:** 23 **Recl D:** 66.5 **TV Recl:** 56.5 **Wall Cir:** 4
Weight: 137 lbs **Cube:** 32.7

D	E	F	G	H	J	K ^{COM}	L	M	N	O	P	Q	R	S	T	U	(# above U) *	S Nail	M Nail
2697	N/A	N/A	N/A	N/A	N/A	N/A	N/A	N/A	N/A	N/A	N/A	N/A	N/A	N/A	N/A	N/A	N/A (Riser) + N/A (U)	N/A	N/A
Leather 1		Leather 2		Leather 3		Leather 4		Leather 5		Leather 6		Leather 8		COL		S Nail		M Nail	
N/A		N/A		N/A		N/A		N/A		N/A		N/A		N/A		N/A		N/A	

Fabric SKU: **F006-PR-I** Leather SKU: **N/A**
 THE LEATHER RESERVE
Hailey Power Recliner

Standard Pillows: N/A **Finish Req:** N
Standard Cushions: High Resiliency 35 **Standard Finish:**
COM: N/A yards **COL:** N/A
 Married in 1304 70 Ivory Leather with Brushed Nickel nail trim

Power Articulating Headrest, Outside Power Switch
Width: 34.5 **Depth:** 39 **Height:** 42
AH: 24 **SH:** 20 **SD:** 20 **IW:** 23 **Recl D:** 66.5 **TV Recl:** 56.5 **Wall Cir:** 4
Weight: 137 lbs **Cube:** 32.7

D	E	F	G	H	J	K ^{COM}	L	M	N	O	P	Q	R	S	T	U	(# above U) *	S Nail	M Nail
2697	N/A	N/A	N/A	N/A	N/A	N/A	N/A	N/A	N/A	N/A	N/A	N/A	N/A	N/A	N/A	N/A	N/A (Riser) + N/A (U)	N/A	N/A
Leather 1		Leather 2		Leather 3		Leather 4		Leather 5		Leather 6		Leather 8		COL		S Nail		M Nail	
N/A		N/A		N/A		N/A		N/A		N/A		N/A		N/A		N/A		N/A	

Upholstery

**Pillows are not available on leather SKUs*

Fabric SKU: **F006-PS-D** Leather SKU: **N/A**
THE LEATHER RESERVE

Hailey Power Left and Right Reclining Sofa

Power Articulating Headrest, Outside Power Switch

Width: 81.5 **Depth:** 38.5 **Height:** 42

AH: 24 **SH:** 20 **SD:** 20 **IW:** 70 **Recl D:** 67 **TV Recl:** 56 **Wall Clr:** 5.75

Weight: 291 lbs **Cube:** 76.26

Standard Pillows: N/A **Finish Req:** N

Standard Cushions: High Resiliency 35 **Standard Finish:**

COM: N/A yards **COL:** N/A

Married in 1304 90 Denim Leather with Brushed Nickel nail trim.

D	E	F	G	H	J	K ^{COM}	L	M	N	O	P	Q	R	S	T	U	(# above U) *	S Nail	M Nail
5097	N/A	N/A	N/A	N/A	N/A	N/A	N/A	N/A	N/A	N/A	N/A	N/A	N/A	N/A	N/A	N/A	N/A (Riser) + N/A (U)	N/A	N/A
Leather 1		Leather 2		Leather 3		Leather 4		Leather 5		Leather 6		Leather 8		COL		S Nail		M Nail	
N/A		N/A		N/A		N/A		N/A		N/A		N/A		N/A		N/A		N/A	

Fabric SKU: **F006-PS-I** Leather SKU: **N/A**
THE LEATHER RESERVE

Hailey Power Left and Right Reclining Sofa

Power Articulating Headrest, Outside Power Switch

Width: 81.5 **Depth:** 38.5 **Height:** 42

AH: 24 **SH:** 20 **SD:** 20 **IW:** 70 **Recl D:** 67 **TV Recl:** 56 **Wall Clr:** 5.75

Weight: 291 lbs **Cube:** 76.26

Standard Pillows: N/A **Finish Req:** N

Standard Cushions: High Resiliency 35 **Standard Finish:**

COM: N/A yards **COL:** N/A

Married in 1304 70 Ivory Leather with Brushed Nickel nail trim

D	E	F	G	H	J	K ^{COM}	L	M	N	O	P	Q	R	S	T	U	(# above U) *	S Nail	M Nail
5097	N/A	N/A	N/A	N/A	N/A	N/A	N/A	N/A	N/A	N/A	N/A	N/A	N/A	N/A	N/A	N/A	N/A (Riser) + N/A (U)	N/A	N/A
Leather 1		Leather 2		Leather 3		Leather 4		Leather 5		Leather 6		Leather 8		COL		S Nail		M Nail	
N/A		N/A		N/A		N/A		N/A		N/A		N/A		N/A		N/A		N/A	

Fabric SKU: **F007-PR-C** Leather SKU: **N/A**
THE LEATHER RESERVE

Ashley Power Recliner

Power Articulating Headrest, Outside Power Switch

Width: 33.5 **Depth:** 39.5 **Height:** 41

AH: 24 **SH:** 18.75 **SD:** 21 **IW:** 23 **Recl D:** 67 **TV Recl:** 58 **Wall Clr:** 5

Weight: 152 lbs **Cube:** 31.39

Standard Pillows: N/A **Finish Req:** N

Standard Cushions: High Resiliency 35 **Standard Finish:**

COM: N/A yards **COL:** N/A

Married in 1301 Slope Leather. Also available in F007-PR-K 1302 Khaki.

D	E	F	G	H	J	K ^{COM}	L	M	N	O	P	Q	R	S	T	U	(# above U) *	S Nail	M Nail
2997	N/A	N/A	N/A	N/A	N/A	N/A	N/A	N/A	N/A	N/A	N/A	N/A	N/A	N/A	N/A	N/A	N/A (Riser) + N/A (U)	N/A	N/A
Leather 1		Leather 2		Leather 3		Leather 4		Leather 5		Leather 6		Leather 8		COL		S Nail		M Nail	
N/A		N/A		N/A		N/A		N/A		N/A		N/A		N/A		N/A		N/A	

Fabric SKU: **F007-PR-K** Leather SKU: **N/A**
THE LEATHER RESERVE

Ashley Power Recliner

Power Articulating Headrest, Outside Power Switch

Width: 33.5 **Depth:** 39.5 **Height:** 41

AH: 24 **SH:** 18.75 **SD:** 21 **IW:** 23 **Recl D:** 67 **TV Recl:** 58 **Wall Clr:** 5

Weight: 152 lbs **Cube:** 31.39

Standard Pillows: N/A **Finish Req:** N

Standard Cushions: High Resiliency 35 **Standard Finish:**

COM: N/A yards **COL:** N/A

Married in 1302 Khaki Leather. Also available in F007-PR-C 1301 Slope.

D	E	F	G	H	J	K ^{COM}	L	M	N	O	P	Q	R	S	T	U	(# above U) *	S Nail	M Nail
2997	N/A	N/A	N/A	N/A	N/A	N/A	N/A	N/A	N/A	N/A	N/A	N/A	N/A	N/A	N/A	N/A	N/A (Riser) + N/A (U)	N/A	N/A
Leather 1		Leather 2		Leather 3		Leather 4		Leather 5		Leather 6		Leather 8		COL		S Nail		M Nail	
N/A		N/A		N/A		N/A		N/A		N/A		N/A		N/A		N/A		N/A	

Fabric SKU: **F007-PS-C** Leather SKU: **N/A**
THE LEATHER RESERVE

Ashley Power Left and Right Reclining Sofa

Power Articulating Headrest, Outside Power Switch

Width: 80.5 **Depth:** 40 **Height:** 42

AH: 24 **SH:** 18 **SD:** 20 **IW:** 70 **Recl D:** 66.5 **TV Recl:** 55 **Wall Clr:** 5.75

Weight: 300 lbs **Cube:** 78.26

Standard Pillows: N/A **Finish Req:** N

Standard Cushions: High Resiliency 35 **Standard Finish:**

COM: N/A yards **COL:** N/A

Married in 1301 Slope Leather. Also available in F007-PS-K 1302 Khaki.

D	E	F	G	H	J	K ^{COM}	L	M	N	O	P	Q	R	S	T	U	(# above U) *	S Nail	M Nail
5697	N/A	N/A	N/A	N/A	N/A	N/A	N/A	N/A	N/A	N/A	N/A	N/A	N/A	N/A	N/A	N/A	N/A (Riser) + N/A (U)	N/A	N/A
Leather 1		Leather 2		Leather 3		Leather 4		Leather 5		Leather 6		Leather 8		COL		S Nail		M Nail	
N/A		N/A		N/A		N/A		N/A		N/A		N/A		N/A		N/A		N/A	

Fabric SKU: **F007-PS-K** Leather SKU: **N/A**
THE LEATHER RESERVE

Ashley Power Left and Right Reclining Sofa

Power Articulating Headrest, Outside Power Switch

Width: 80.5 **Depth:** 40 **Height:** 42

AH: 24 **SH:** 18 **SD:** 20 **IW:** 70 **Recl D:** 66.5 **TV Recl:** 55 **Wall Clr:** 5.75

Weight: 300 lbs **Cube:** 78.26

Standard Pillows: N/A **Finish Req:** N

Standard Cushions: High Resiliency 35 **Standard Finish:**

COM: N/A yards **COL:** N/A

Married in 1302 Khaki Leather. Also available in F007-PS-C 1301 Slope.

D	E	F	G	H	J	K ^{COM}	L	M	N	O	P	Q	R	S	T	U	(# above U) *	S Nail	M Nail
5697	N/A	N/A	N/A	N/A	N/A	N/A	N/A	N/A	N/A	N/A	N/A	N/A	N/A	N/A	N/A	N/A	N/A (Riser) + N/A (U)	N/A	N/A
Leather 1		Leather 2		Leather 3		Leather 4		Leather 5		Leather 6		Leather 8		COL		S Nail		M Nail	
N/A		N/A		N/A		N/A		N/A		N/A		N/A		N/A		N/A		N/A	

Upholstery

**Pillows are not available on leather SKUs*

Fabric SKU: **F008-PR** Leather SKU: **N/A**

THE LEATHER RESERVE

Karlle Power Recliner

Power Articulating Headrest, Outside Power Switch

Width: 28.5 **Depth:** 36 **Height:** 42

AH: 24 **SH:** 19.75 **SD:** 19 **IW:** 21.5 **Recl D:** 66 **TV Recl:** 60 **Wall Clr:** 17.25

Weight: 152 lbs **Cube:** 24.93

Standard Pillows: N/A **Finish Req:** N

Standard Cushions: High Resiliency 35 **Standard Finish:** Tobacco

COM: N/A yards **COL:** N/A

Married in 1300 71 Linen Leather

D	E	F	G	H	J	K ^{COM}	L	M	N	O	P	Q	R	S	T	U	(# above U) *	S Nail	M Nail
2697	N/A	N/A	N/A	N/A	N/A	N/A	N/A	N/A	N/A	N/A	N/A	N/A	N/A	N/A	N/A	N/A	N/A (Riser) + N/A (U)	N/A	N/A
Leather 1		Leather 2		Leather 3		Leather 4		Leather 5		Leather 6		Leather 8		COL		S Nail		M Nail	
N/A		N/A		N/A		N/A		N/A		N/A		N/A		N/A		N/A		N/A	

Fabric SKU: **F009-PR** Leather SKU: **N/A**

THE LEATHER RESERVE

Claudia Power Recliner

Power Articulating Headrest, Outside Power Switch

Width: 28.5 **Depth:** 37 **Height:** 42

AH: 24 **SH:** 20 **SD:** 19.5 **IW:** 21 **Recl D:** 66 **TV Recl:** 60 **Wall Clr:** 16.5

Weight: 115 lbs **Cube:** 25.63

Standard Pillows: N/A **Finish Req:** N

Standard Cushions: High Resiliency 35 **Standard Finish:** Tobacco

COM: N/A yards **COL:** N/A

Married in 1301 Cliff Leather

D	E	F	G	H	J	K ^{COM}	L	M	N	O	P	Q	R	S	T	U	(# above U) *	S Nail	M Nail
2697	N/A	N/A	N/A	N/A	N/A	N/A	N/A	N/A	N/A	N/A	N/A	N/A	N/A	N/A	N/A	N/A	N/A (Riser) + N/A (U)	N/A	N/A
Leather 1		Leather 2		Leather 3		Leather 4		Leather 5		Leather 6		Leather 8		COL		S Nail		M Nail	
N/A		N/A		N/A		N/A		N/A		N/A		N/A		N/A		N/A		N/A	

Fabric SKU: **F012-04** Leather SKU: **N/A**

READY-TO-SHIP UPHOLSTERY

Gabriella Arm Chair

Width: 23.25 **Depth:** 23 **Height:** 28

AH: 25 **SH:** 19.25 **SD:** 20 **IW:** 21

Weight: 62 lbs **Cube:** 8.66

Standard Pillows: N/A **Finish Req:** N

Standard Cushions: High Resiliency 40 **Standard Finish:** Tahitian Pearl

COM: N/A yards **COL:** N/A

Married in Tahitian Pearl with Black Steel accents and performance fabric 3343 Ecu.

D	E	F	G	H	J	K ^{COM}	L	M	N	O	P	Q	R	S	T	U	(# above U) *	S Nail	M Nail
1197	N/A	N/A	N/A	N/A	N/A	N/A	N/A	N/A	N/A	N/A	N/A	N/A	N/A	N/A	N/A	N/A	N/A (Riser) + N/A (U)	N/A	N/A
Leather 1		Leather 2		Leather 3		Leather 4		Leather 5		Leather 6		Leather 8		COL		S Nail		M Nail	
N/A		N/A		N/A		N/A		N/A		N/A		N/A		N/A		N/A		N/A	

Fabric SKU: **F012-C6** Leather SKU: **N/A**

READY-TO-SHIP UPHOLSTERY

Gabriella Counter Stool

Width: 23 **Depth:** 22.75 **Height:** 34

AH: 0 **SH:** 0 **SD:** 0 **IW:** 0

Weight: 71 lbs **Cube:** 10.29

Standard Pillows: N/A **Finish Req:** N

Standard Cushions: High Resiliency 40 **Standard Finish:** Tahitian Pearl

COM: N/A yards **COL:** N/A

Married in Tahitian Pearl with Black Steel accents and performance fabric 3343 Ecu.

D	E	F	G	H	J	K ^{COM}	L	M	N	O	P	Q	R	S	T	U	(# above U) *	S Nail	M Nail
1347	N/A	N/A	N/A	N/A	N/A	N/A	N/A	N/A	N/A	N/A	N/A	N/A	N/A	N/A	N/A	N/A	N/A (Riser) + N/A (U)	N/A	N/A
Leather 1		Leather 2		Leather 3		Leather 4		Leather 5		Leather 6		Leather 8		COL		S Nail		M Nail	
N/A		N/A		N/A		N/A		N/A		N/A		N/A		N/A		N/A		N/A	

Fabric SKU: **F013-04** Leather SKU: **N/A**

READY-TO-SHIP UPHOLSTERY

Portside Arm Chair

Width: 23 **Depth:** 24.25 **Height:** 35

AH: 24.5 **SH:** 19.25 **SD:** 21.5 **IW:** 19.75

Weight: 31 lbs **Cube:** 15.89

Standard Pillows: N/A **Finish Req:** N

Standard Cushions: High Resiliency 30 **Standard Finish:** Natural

COM: N/A yards **COL:** N/A

Married in Linen in a Natural Mango finish with a Raffia back. Features natural cane accents that are handwoven using the peel of natural rattan. As with any natural product, nature's imperfections and hallmarks will be present in the cane materials. Cane is a handcrafted product dating back to the Ancient Egyptians.

D	E	F	G	H	J	K ^{COM}	L	M	N	O	P	Q	R	S	T	U	(# above U) *	S Nail	M Nail
1740	N/A	N/A	N/A	N/A	N/A	N/A	N/A	N/A	N/A	N/A	N/A	N/A	N/A	N/A	N/A	N/A	N/A (Riser) + N/A (U)	N/A	N/A
Leather 1		Leather 2		Leather 3		Leather 4		Leather 5		Leather 6		Leather 8		COL		S Nail		M Nail	
N/A		N/A		N/A		N/A		N/A		N/A		N/A		N/A		N/A		N/A	

Fabric SKU: **F013-05** Leather SKU: **N/A**

READY-TO-SHIP UPHOLSTERY

Portside Side Chair

Width: 21 **Depth:** 24.5 **Height:** 35

AH: 0 **SH:** 19 **SD:** 21.5 **IW:** 21

Weight: 28 lbs **Cube:** 15.23

Standard Pillows: N/A **Finish Req:** N

Standard Cushions: High Resiliency 30 **Standard Finish:** Natural

COM: N/A yards **COL:** N/A

Married in Linen in a Natural Mango finish with a Raffia back. Features natural cane accents that are handwoven using the peel of natural rattan. As with any natural product, nature's imperfections and hallmarks will be present in the cane materials. Cane is a handcrafted product dating back to the Ancient Egyptians.

D	E	F	G	H	J	K ^{COM}	L	M	N	O	P	Q	R	S	T	U	(# above U) *	S Nail	M Nail
1740	N/A	N/A	N/A	N/A	N/A	N/A	N/A	N/A	N/A	N/A	N/A	N/A	N/A	N/A	N/A	N/A	N/A (Riser) + N/A (U)	N/A	N/A
Leather 1		Leather 2		Leather 3		Leather 4		Leather 5		Leather 6		Leather 8		COL		S Nail		M Nail	
N/A		N/A		N/A		N/A		N/A		N/A		N/A		N/A		N/A		N/A	

Upholstery

**Pillows are not available on leather SKUs*

Fabric SKU: **F014-PR** Leather SKU: **N/A**

THE LEATHER RESERVE

Adriana Power Recliner

Power Articulating Headrest, Outside Power Switch

Width: 30.5 **Depth:** 36 **Height:** 42

AH: 25.5 **SH:** 20 **SD:** 19 **IW:** 21 **Recl D:** 67 **TV Recl:** 59 **Wall Clr:** 18

Weight: 131 lbs **Cube:** 26.68

Standard Pillows: N/A **Finish Req:** N

Standard Cushions: High Resiliency 35 **Standard Finish:** Tobacco

COM: N/A yards **COL:** N/A

Married in 1115 61 Charcoal with a woven braided trim detail.

D	E	F	G	H	J	K ^{COM}	L	M	N	O	P	Q	R	S	T	U	(# above U) *	S Nail	M Nail
2997	N/A	N/A	N/A	N/A	N/A	N/A	N/A	N/A	N/A	N/A	N/A	N/A	N/A	N/A	N/A	N/A	N/A (Riser) + N/A (U)	N/A	N/A
Leather 1		Leather 2		Leather 3		Leather 4		Leather 5		Leather 6		Leather 8		COL		S Nail		M Nail	
N/A		N/A		N/A		N/A		N/A		N/A		N/A		N/A		N/A		N/A	

Fabric SKU: **F015-31** Leather SKU: **N/A**

THE LEATHER RESERVE

Gisele Swivel Chair

Width: 29 **Depth:** 32.5 **Height:** 34.75

AH: 23.25 **SH:** 19 **SD:** 21.5 **IW:** 22

Weight: 115 lbs **Cube:** 18.95

Standard Pillows: N/A **Finish Req:** N

Standard Cushions: High Resiliency 35 **Standard Finish:**

COM: N/A yards **COL:** N/A

Married in 1307 10 Oak. Features a flanged leather trim detail and large pleated inside back and inside arm.

D	E	F	G	H	J	K ^{COM}	L	M	N	O	P	Q	R	S	T	U	(# above U) *	S Nail	M Nail
2097	N/A	N/A	N/A	N/A	N/A	N/A	N/A	N/A	N/A	N/A	N/A	N/A	N/A	N/A	N/A	N/A	N/A (Riser) + N/A (U)	N/A	N/A
Leather 1		Leather 2		Leather 3		Leather 4		Leather 5		Leather 6		Leather 8		COL		S Nail		M Nail	
N/A		N/A		N/A		N/A		N/A		N/A		N/A		N/A		N/A		N/A	

Fabric SKU: **F016-PR** Leather SKU: **N/A**

THE LEATHER RESERVE

Naomi Power Recliner

Power Articulating Headrest, Outside Power Switch

Width: 28 **Depth:** 37.5 **Height:** 42

AH: 26 **SH:** 21 **SD:** 21 **IW:** 21 **Recl D:** 67 **TV Recl:** 62 **Wall Clr:** 17.5

Weight: 117 lbs **Cube:** 25.52

Standard Pillows: N/A **Finish Req:** N

Standard Cushions: High Resiliency 35 **Standard Finish:** Tobacco

COM: N/A yards **COL:** N/A

Married in 1303 68 Pewter Leather

D	E	F	G	H	J	K ^{COM}	L	M	N	O	P	Q	R	S	T	U	(# above U) *	S Nail	M Nail
2697	N/A	N/A	N/A	N/A	N/A	N/A	N/A	N/A	N/A	N/A	N/A	N/A	N/A	N/A	N/A	N/A	N/A (Riser) + N/A (U)	N/A	N/A
Leather 1		Leather 2		Leather 3		Leather 4		Leather 5		Leather 6		Leather 8		COL		S Nail		M Nail	
N/A		N/A		N/A		N/A		N/A		N/A		N/A		N/A		N/A		N/A	

Fabric SKU: **F023-31** Leather SKU: **N/A**

THE LEATHER RESERVE

Miranda Swivel Chair

Width: 32 **Depth:** 33 **Height:** 34.25

AH: 27 **SH:** 21 **SD:** 21.5 **IW:** 21.5

Weight: 115 lbs **Cube:** 20.93

Standard Pillows: N/A **Finish Req:** N

Standard Cushions: Classic Plush **Standard Finish:**

COM: N/A yards **COL:** N/A

Married in 1308 72 Pearl Leather. Features a diamond quilted outarm and outback detail.

D	E	F	G	H	J	K ^{COM}	L	M	N	O	P	Q	R	S	T	U	(# above U) *	S Nail	M Nail
2397	N/A	N/A	N/A	N/A	N/A	N/A	N/A	N/A	N/A	N/A	N/A	N/A	N/A	N/A	N/A	N/A	N/A (Riser) + N/A (U)	N/A	N/A
Leather 1		Leather 2		Leather 3		Leather 4		Leather 5		Leather 6		Leather 8		COL		S Nail		M Nail	
N/A		N/A		N/A		N/A		N/A		N/A		N/A		N/A		N/A		N/A	

Fabric SKU: **F025-PL-F** Leather SKU: **N/A**

THE LEATHER RESERVE

Millie Track Arm Power Lift Recliner

Power Recline, Tethered Power Wand

Width: 29.25 **Depth:** 36.5 **Height:** 40

AH: 24 **SH:** 19 **SD:** 20 **IW:** 21 **Recl D:** 64 **TV Recl:** 54 **Wall Clr:** 8

Weight: 150 lbs **Cube:** 24.71

Standard Pillows: N/A **Finish Req:** N

Standard Cushions: Endurance **Standard Finish:**

COM: N/A yards **COL:** N/A

Married in 3019-31 Fog (Grade Q, Cleaning Code WS). No custom options available.

D	E	F	G	H	J	K ^{COM}	L	M	N	O	P	Q	R	S	T	U	(# above U) *	S Nail	M Nail
2097	N/A	N/A	N/A	N/A	N/A	N/A	N/A	N/A	N/A	N/A	N/A	N/A	N/A	N/A	N/A	N/A	N/A (Riser) + N/A (U)	N/A	N/A
Leather 1		Leather 2		Leather 3		Leather 4		Leather 5		Leather 6		Leather 8		COL		S Nail		M Nail	
N/A		N/A		N/A		N/A		N/A		N/A		N/A		N/A		N/A		N/A	

Fabric SKU: **F031-35** Leather SKU: **N/A**

THE LEATHER RESERVE

Wriggly Office Swivel Chair

Width: 29.5 **Depth:** 28 **Height:** 0

AH: 0 **SH:** 0 **SD:** 20 **IW:** 19.5

Weight: 76 lbs **Cube:** 16.38

Standard Pillows: N/A **Finish Req:** N

Standard Cushions: N/A **Standard Finish:** Black Nickel

COM: N/A yards **COL:** N/A

Married in 1134 Coffee leather with contrast welt and button in 1134 Fossil leather. Black nickel metal base.

D	E	F	G	H	J	K ^{COM}	L	M	N	O	P	Q	R	S	T	U	(# above U) *	S Nail	M Nail
N/A	N/A	N/A	N/A	N/A	N/A	N/A	N/A	N/A	N/A	N/A	N/A	N/A	N/A	N/A	N/A	N/A	N/A (Riser) + N/A (U)	N/A	N/A
Leather 1		Leather 2		Leather 3		Leather 4		Leather 5		Leather 6		Leather 8		COL		S Nail		M Nail	
3090		N/A		N/A		N/A		N/A		N/A		N/A		N/A		N/A		N/A	

Upholstery

**Pillows are not available on leather SKUs*

Fabric SKU: **F032-35** Leather SKU: **N/A**
 THE LEATHER RESERVE
Gherkin Office Swivel Chair

Standard Pillows: N/A **Finish Req:** N
Standard Cushions: N/A **Standard Finish:** Black Nickel
COM: N/A yards **COL:** N/A
 Married in 1132 Fudge leather with contrast welt and button in 1134 Fossil leather. Black Nickel metal Base.

Width: 27 **Depth:** 27 **Height:** 0
AH: 0 **SH:** 0 **SD:** 19.5 **IW:** 20
Weight: 68 lbs **Cube:** 13.81

D	E	F	G	H	J	K ^{COM}	L	M	N	O	P	Q	R	S	T	U	(# above U) *	S Nail	M Nail
N/A	N/A	N/A	N/A	N/A	N/A	N/A	N/A	N/A	N/A	N/A	N/A	N/A	N/A	N/A	N/A	N/A	N/A (Riser) + N/A (U)	N/A	N/A
Leather 1 3090		Leather 2 N/A		Leather 3 N/A		Leather 4 N/A		Leather 5 N/A		Leather 6 N/A		Leather 8 N/A		COL N/A		S Nail N/A		M Nail N/A	

Fabric SKU: **F033-PR-N** Leather SKU: **N/A**
 THE LEATHER RESERVE
Xavier Power Recliner, Double Incline

Standard Pillows: N/A **Finish Req:** N
Standard Cushions: Classic Plush **Standard Finish:** Tobacco
COM: N/A yards **COL:** N/A
 Married in 1314-61 Night with Black Nickel nailhead trim. No custom options available.

Power Articulating Headrest, Outside Power Switch
Width: 31 **Depth:** 39 **Height:** 43
AH: 25.5 **SH:** 20 **SD:** 20.5 **IW:** 23 **Recl D:** 68.5 **TV Recl:** 60 **Wall Clr:** 17
Weight: 150 lbs **Cube:** 30.08

D	E	F	G	H	J	K ^{COM}	L	M	N	O	P	Q	R	S	T	U	(# above U) *	S Nail	M Nail
2787	N/A	N/A	N/A	N/A	N/A	N/A	N/A	N/A	N/A	N/A	N/A	N/A	N/A	N/A	N/A	N/A	N/A (Riser) + N/A (U)	N/A	N/A
Leather 1 N/A		Leather 2 N/A		Leather 3 N/A		Leather 4 N/A		Leather 5 N/A		Leather 6 N/A		Leather 8 N/A		COL N/A		S Nail N/A		M Nail N/A	

Fabric SKU: **F033-PR-T** Leather SKU: **N/A**
 THE LEATHER RESERVE
Xavier Power Recliner, Double Incline

Standard Pillows: N/A **Finish Req:** N
Standard Cushions: Classic Plush **Standard Finish:** Tobacco
COM: N/A yards **COL:** N/A
 Married in 1314-17 Truffle with Black Nickel nailhead trim. No custom options available.

Power Articulating Headrest, Outside Power Switch
Width: 31 **Depth:** 39 **Height:** 43
AH: 25.5 **SH:** 20 **SD:** 20.5 **IW:** 23 **Recl D:** 68.5 **TV Recl:** 60 **Wall Clr:** 17
Weight: 150 lbs **Cube:** 30.08

D	E	F	G	H	J	K ^{COM}	L	M	N	O	P	Q	R	S	T	U	(# above U) *	S Nail	M Nail
2787	N/A	N/A	N/A	N/A	N/A	N/A	N/A	N/A	N/A	N/A	N/A	N/A	N/A	N/A	N/A	N/A	N/A (Riser) + N/A (U)	N/A	N/A
Leather 1 N/A		Leather 2 N/A		Leather 3 N/A		Leather 4 N/A		Leather 5 N/A		Leather 6 N/A		Leather 8 N/A		COL N/A		S Nail N/A		M Nail N/A	

Fabric SKU: **F035-PR-B** Leather SKU: **N/A**
 THE LEATHER RESERVE
Rohan Power Recliner

Standard Pillows: N/A **Finish Req:** N
Standard Cushions: Classic Plush **Standard Finish:** Tobacco
COM: N/A yards **COL:** N/A
 Married in 1315-07 Barley. No custom options available.

Outside Power Switch
Width: 34.5 **Depth:** 37.5 **Height:** 40.5
AH: 25.5 **SH:** 21 **SD:** 23 **IW:** 22.5 **Recl D:** 68 **TV Recl:** 57.5 **Wall Clr:** 17
Weight: 115 lbs **Cube:** 30.32

D	E	F	G	H	J	K ^{COM}	L	M	N	O	P	Q	R	S	T	U	(# above U) *	S Nail	M Nail
2697	N/A	N/A	N/A	N/A	N/A	N/A	N/A	N/A	N/A	N/A	N/A	N/A	N/A	N/A	N/A	N/A	N/A (Riser) + N/A (U)	N/A	N/A
Leather 1 N/A		Leather 2 N/A		Leather 3 N/A		Leather 4 N/A		Leather 5 N/A		Leather 6 N/A		Leather 8 N/A		COL N/A		S Nail N/A		M Nail N/A	

Fabric SKU: **F042-01-C** Leather SKU: **N/A**
 THE LEATHER RESERVE
Maverick Lounge Chair

Standard Pillows: N/A **Finish Req:** N
Standard Cushions: Classic Plush **Standard Finish:** Black Nickel
COM: N/A yards **COL:** N/A
 Married in 1316-03 Cider with stitching detail in 1303-04 Brown

Width: 30.5 **Depth:** 33 **Height:** 37
AH: 22.5 **SH:** 20 **SD:** 21.5 **IW:** 24.5
Weight: 66 lbs **Cube:** 21.55

D	E	F	G	H	J	K ^{COM}	L	M	N	O	P	Q	R	S	T	U	(# above U) *	S Nail	M Nail
1947	N/A	N/A	N/A	N/A	N/A	N/A	N/A	N/A	N/A	N/A	N/A	N/A	N/A	N/A	N/A	N/A	N/A (Riser) + N/A (U)	N/A	N/A
Leather 1 N/A		Leather 2 N/A		Leather 3 N/A		Leather 4 N/A		Leather 5 N/A		Leather 6 N/A		Leather 8 N/A		COL N/A		S Nail N/A		M Nail N/A	

Fabric SKU: **F045-PR-L** Leather SKU: **N/A**
 THE LEATHER RESERVE
Cisco Power Recliner

Standard Pillows: N/A **Finish Req:** N
Standard Cushions: Classic Plush **Standard Finish:** Mica
COM: N/A yards **COL:** N/A
 Married in 1303-70 Gibson. No custom options available. No custom options available.

Power Articulating Headrest, Outside Power Switch
Width: 34 **Depth:** 40 **Height:** 43
AH: 25 **SH:** 21 **SD:** 20.5 **IW:** 21.5 **Recl D:** 72 **TV Recl:** 61.5 **Wall Clr:** 18
Weight: 150 lbs **Cube:** 33.84

D	E	F	G	H	J	K ^{COM}	L	M	N	O	P	Q	R	S	T	U	(# above U) *	S Nail	M Nail
2697	N/A	N/A	N/A	N/A	N/A	N/A	N/A	N/A	N/A	N/A	N/A	N/A	N/A	N/A	N/A	N/A	N/A (Riser) + N/A (U)	N/A	N/A
Leather 1 N/A		Leather 2 N/A		Leather 3 N/A		Leather 4 N/A		Leather 5 N/A		Leather 6 N/A		Leather 8 N/A		COL N/A		S Nail N/A		M Nail N/A	

Upholstery

**Pillows are not available on leather SKUs*

Fabric SKU: **F046-35** Leather SKU: **N/A**
 THE LEATHER RESERVE
Plaza 66 Office Swivel Chair

Standard Pillows: N/A **Finish Req:** N
Standard Cushions: N/A **Standard Finish:** Black Nickel
COM: N/A yards **COL:** N/A
 Married in 1117 Chocolate leather with small Black Nickel nail head trim. Black Nickel metal base.

Width: 28.25 **Depth:** 31.75 **Height:** 43
AH: 0 **SH:** 0 **SD:** 20.75 **IW:** 19.5
Weight: 71 lbs **Cube:** 19.06

D	E	F	G	H	J	K COM	L	M	N	O	P	Q	R	S	T	U	(# above U) *	S Nail	M Nail
N/A	N/A	N/A	N/A	N/A	N/A	N/A	N/A	N/A	N/A	N/A	N/A	N/A	N/A	N/A	N/A	N/A	N/A (Riser) + N/A (U)	N/A	N/A
Leather 1 3285		Leather 2 N/A		Leather 3 N/A		Leather 4 N/A		Leather 5 N/A		Leather 6 N/A		Leather 8 N/A		COL N/A		S Nail N/A		M Nail N/A	

Fabric SKU: **F048-PR-S** Leather SKU: **N/A**
 THE LEATHER RESERVE
Rory Power Recliner with Swivel
 Power Articulating Headrest, Outside Power Switch

Standard Pillows: N/A **Finish Req:** N
Standard Cushions: Classic Plush **Standard Finish:**
COM: N/A yards **COL:** N/A
 Married in 1317-63 Smoke. No custom options available.

Width: 31 **Depth:** 39 **Height:** 43
AH: 24 **SH:** 20.5 **SD:** 20.5 **IW:** 21 **Recl D:** 66 **TV Recl:** 59 **Wall Clr:** 10
Weight: 172 lbs **Cube:** 30.08

D	E	F	G	H	J	K COM	L	M	N	O	P	Q	R	S	T	U	(# above U) *	S Nail	M Nail
3387	N/A	N/A	N/A	N/A	N/A	N/A	N/A	N/A	N/A	N/A	N/A	N/A	N/A	N/A	N/A	N/A	N/A (Riser) + N/A (U)	N/A	N/A
Leather 1 N/A		Leather 2 N/A		Leather 3 N/A		Leather 4 N/A		Leather 5 N/A		Leather 6 N/A		Leather 8 N/A		COL N/A		S Nail N/A		M Nail N/A	

Fabric SKU: **F050-31** Leather SKU: **N/A**
 THE LEATHER RESERVE
Beck Swivel Chair

Standard Pillows: N/A **Finish Req:** N
Standard Cushions: Classic Plush **Standard Finish:**
COM: N/A yards **COL:** N/A
 Married in 1303-70 Gibson. No custom options available.

Width: 29 **Depth:** 36 **Height:** 34
AH: 23.5 **SH:** 18.5 **SD:** 20.5 **IW:** 22
Weight: 130 lbs **Cube:** 20.54

D	E	F	G	H	J	K COM	L	M	N	O	P	Q	R	S	T	U	(# above U) *	S Nail	M Nail
2187	N/A	N/A	N/A	N/A	N/A	N/A	N/A	N/A	N/A	N/A	N/A	N/A	N/A	N/A	N/A	N/A	N/A (Riser) + N/A (U)	N/A	N/A
Leather 1 N/A		Leather 2 N/A		Leather 3 N/A		Leather 4 N/A		Leather 5 N/A		Leather 6 N/A		Leather 8 N/A		COL N/A		S Nail N/A		M Nail N/A	

Fabric SKU: **F051-31** Leather SKU: **N/A**
 THE LEATHER RESERVE
Graham Swivel Chair

Standard Pillows: N/A **Finish Req:** N
Standard Cushions: High Resiliency 30 **Standard Finish:**
COM: N/A yards **COL:** N/A
 Married in leather 1313-90 Night. No custom options available.

Width: 33.5 **Depth:** 30 **Height:** 30
AH: 24.5 **SH:** 18 **SD:** 22 **IW:** 33.5
Weight: 65 lbs **Cube:** 17.44

D	E	F	G	H	J	K COM	L	M	N	O	P	Q	R	S	T	U	(# above U) *	S Nail	M Nail
2097	N/A	N/A	N/A	N/A	N/A	N/A	N/A	N/A	N/A	N/A	N/A	N/A	N/A	N/A	N/A	N/A	N/A (Riser) + N/A (U)	N/A	N/A
Leather 1 N/A		Leather 2 N/A		Leather 3 N/A		Leather 4 N/A		Leather 5 N/A		Leather 6 N/A		Leather 8 N/A		COL N/A		S Nail N/A		M Nail N/A	

Fabric SKU: **F058-35** Leather SKU: **N/A**
 THE LEATHER RESERVE, WORKREADY
Chase Office Swivel Chair

Standard Pillows: N/A **Finish Req:** N
Standard Cushions: N/A **Standard Finish:**
COM: N/A yards **COL:** N/A
 Married in 1131 Chocolate leather with small Brass nail head trim. Black Nickel metal base with antique brass casters.

Width: 27.5 **Depth:** 30 **Height:** 40.25
AH: 0 **SH:** 0 **SD:** 19.5 **IW:** 18.25
Weight: 68 lbs **Cube:** 17.66

D	E	F	G	H	J	K COM	L	M	N	O	P	Q	R	S	T	U	(# above U) *	S Nail	M Nail
N/A	N/A	N/A	N/A	N/A	N/A	N/A	N/A	N/A	N/A	N/A	N/A	N/A	N/A	N/A	N/A	N/A	N/A (Riser) + N/A (U)	N/A	N/A
Leather 1 3000		Leather 2 N/A		Leather 3 N/A		Leather 4 N/A		Leather 5 N/A		Leather 6 N/A		Leather 8 N/A		COL N/A		S Nail N/A		M Nail N/A	

Fabric SKU: **F062-35** Leather SKU: **N/A**
 THE LEATHER RESERVE, WORKREADY
The Shard Office Swivel Chair

Standard Pillows: N/A **Finish Req:** N
Standard Cushions: N/A **Standard Finish:** Hill Country
COM: N/A yards **COL:** N/A
 Married in 1133 Hickory leather with small Brass nail head trim. Wooden base in Hill Country finish.

Width: 25.5 **Depth:** 30 **Height:** 0
AH: 0 **SH:** 0 **SD:** 20 **IW:** 20.75
Weight: 82 lbs **Cube:** 17.9

D	E	F	G	H	J	K COM	L	M	N	O	P	Q	R	S	T	U	(# above U) *	S Nail	M Nail
N/A	N/A	N/A	N/A	N/A	N/A	N/A	N/A	N/A	N/A	N/A	N/A	N/A	N/A	N/A	N/A	N/A	N/A (Riser) + N/A (U)	N/A	N/A
Leather 1 3420		Leather 2 N/A		Leather 3 N/A		Leather 4 N/A		Leather 5 N/A		Leather 6 N/A		Leather 8 N/A		COL N/A		S Nail N/A		M Nail N/A	

Upholstery

**Pillows are not available on leather SKUs*

Fabric SKU: **F468-01-C** Leather SKU: **N/A**
 THE LEATHER RESERVE
Soho Lounge Chair

Standard Pillows: N/A **Finish Req:** N
Standard Cushions: Ultra Plush **Standard Finish:** Espresso
COM: N/A yards **COL:** N/A
 Married in 1115 Charcoal leather. Wooden base in Espresso finish.

Width: 26.75 **Depth:** 31.75 **Height:** 30.25
AH: 23.25 **SH:** 20 **SD:** 23 **IW:** 18.75
Weight: 49 lbs **Cube:** 23.89

D	E	F	G	H	J	K COM	L	M	N	O	P	Q	R	S	T	U	(# above U) *	S Nail	M Nail
N/A	N/A	N/A	N/A	N/A	N/A	N/A	N/A	N/A	N/A	N/A	N/A	N/A	N/A	N/A	N/A	N/A	N/A (Riser) + N/A (U)	N/A	N/A
Leather 1 2055		Leather 2 N/A		Leather 3 N/A		Leather 4 N/A		Leather 5 N/A		Leather 6 N/A		Leather 8 N/A		COL N/A		S Nail N/A		M Nail N/A	

Fabric SKU: **F477-01** Leather SKU: **N/A**
 THE LEATHER RESERVE
Aero Lounge Chair

Standard Pillows: N/A **Finish Req:** N
Standard Cushions: Ultra Plush **Standard Finish:** Espresso
COM: N/A yards **COL:** N/A
 Married in 1126 Brown wipe-off leather with quilted inside back, inside arms and top of seat cushion. Wooden base in Espresso finish. (Chair and Ottoman sold together, not sold individually)

Width: 35.5 **Depth:** 36 **Height:** 28
AH: 28 **SH:** 20.5 **SD:** 23 **IW:** 20
Weight: 89 lbs **Cube:** 36.49

D	E	F	G	H	J	K COM	L	M	N	O	P	Q	R	S	T	U	(# above U) *	S Nail	M Nail
N/A	N/A	N/A	N/A	N/A	N/A	N/A	N/A	N/A	N/A	N/A	N/A	N/A	N/A	N/A	N/A	N/A	N/A (Riser) + N/A (U)	N/A	N/A
Leather 1 2865		Leather 2 N/A		Leather 3 N/A		Leather 4 N/A		Leather 5 N/A		Leather 6 N/A		Leather 8 N/A		COL N/A		S Nail N/A		M Nail N/A	

Fabric SKU: **F477-20** Leather SKU: **N/A**
 THE LEATHER RESERVE
Aero Ottoman

Standard Pillows: N/A **Finish Req:** N
Standard Cushions: Ultra Plush **Standard Finish:** Espresso
COM: N/A yards **COL:** N/A
 Married in 1126 Brown wipe-off leather with quilted top of seat cushion. Wooden base in Espresso finish. (Chair and Ottoman sold together, not sold individually)

Width: 20 **Depth:** 16 **Height:** 17.75
AH: 0 **SH:** 0 **SD:** 0 **IW:** 0
Weight: 27 lbs **Cube:** 10.77

D	E	F	G	H	J	K COM	L	M	N	O	P	Q	R	S	T	U	(# above U) *	S Nail	M Nail
N/A	N/A	N/A	N/A	N/A	N/A	N/A	N/A	N/A	N/A	N/A	N/A	N/A	N/A	N/A	N/A	N/A	N/A (Riser) + N/A (U)	N/A	N/A
Leather 1 1020		Leather 2 N/A		Leather 3 N/A		Leather 4 N/A		Leather 5 N/A		Leather 6 N/A		Leather 8 N/A		COL N/A		S Nail N/A		M Nail N/A	

Fabric SKU: **F486-01** Leather SKU: **N/A**
 THE LEATHER RESERVE
Parisian Lounge Chair

Standard Pillows: N/A **Finish Req:** N
Standard Cushions: Ultra Plush **Standard Finish:** Espresso
COM: N/A yards **COL:** N/A
 Married in 1115 Cocoa leather. Wooden base in Espresso finish. (Chair and Ottoman sold together, not sold individually)

Width: 35 **Depth:** 36.75 **Height:** 37
AH: 25.25 **SH:** 20.5 **SD:** 22.5 **IW:** 21.25
Weight: 75 lbs **Cube:** 29.69

D	E	F	G	H	J	K COM	L	M	N	O	P	Q	R	S	T	U	(# above U) *	S Nail	M Nail
N/A	N/A	N/A	N/A	N/A	N/A	N/A	N/A	N/A	N/A	N/A	N/A	N/A	N/A	N/A	N/A	N/A	N/A (Riser) + N/A (U)	N/A	N/A
Leather 1 2865		Leather 2 N/A		Leather 3 N/A		Leather 4 N/A		Leather 5 N/A		Leather 6 N/A		Leather 8 N/A		COL N/A		S Nail N/A		M Nail N/A	

Fabric SKU: **F486-20** Leather SKU: **N/A**
 THE LEATHER RESERVE
Parisian Ottoman

Standard Pillows: N/A **Finish Req:** N
Standard Cushions: Ultra Plush **Standard Finish:** Espresso
COM: N/A yards **COL:** N/A
 Married in 1115 Cocoa leather. Wooden base in Espresso finish. (Chair and Ottoman sold together, not sold individually)

Width: 25 **Depth:** 20.5 **Height:** 17
AH: 0 **SH:** 0 **SD:** 0 **IW:** 0
Weight: 27 lbs **Cube:** 10.77

D	E	F	G	H	J	K COM	L	M	N	O	P	Q	R	S	T	U	(# above U) *	S Nail	M Nail
N/A	N/A	N/A	N/A	N/A	N/A	N/A	N/A	N/A	N/A	N/A	N/A	N/A	N/A	N/A	N/A	N/A	N/A (Riser) + N/A (U)	N/A	N/A
Leather 1 1020		Leather 2 N/A		Leather 3 N/A		Leather 4 N/A		Leather 5 N/A		Leather 6 N/A		Leather 8 N/A		COL N/A		S Nail N/A		M Nail N/A	

Fabric SKU: **F600-04-B** Leather SKU: **N/A**
 BD COLLECTION FOR FAIRFIELD
Warner Leather Dining Chair

Standard Pillows: N/A **Finish Req:** N
Standard Cushions: High Resiliency 40 **Standard Finish:** Black
COM: N/A yards **COL:** N/A
 Married in a chocolate faux leather with black powder coat finish.

Width: 22.5 **Depth:** 23.5 **Height:** 36.5
AH: 25.5 **SH:** 19 **SD:** 19.5 **IW:** 20.5
Weight: 31 lbs **Cube:** 11.16

D	E	F	G	H	J	K COM	L	M	N	O	P	Q	R	S	T	U	(# above U) *	S Nail	M Nail
N/A	N/A	N/A	N/A	N/A	N/A	N/A	N/A	N/A	N/A	N/A	N/A	N/A	N/A	N/A	N/A	N/A	N/A (Riser) + N/A (U)	N/A	N/A
Leather 1 1497		Leather 2 N/A		Leather 3 N/A		Leather 4 N/A		Leather 5 N/A		Leather 6 N/A		Leather 8 N/A		COL N/A		S Nail N/A		M Nail N/A	

Upholstery

**Pillows are not available on leather SKUs*

Fabric SKU: **F600-C6-B** Leather SKU: **N/A**
 BD COLLECTION FOR FAIRFIELD
Warner Leather Counter Stool

Standard Pillows: N/A **Finish Req:** N
Standard Cushions: High Resiliency 40 **Standard Finish:** Black
COM: N/A yards **COL:** N/A
 Married in a chocolate faux leather with black powder coat finish.

Width: 21 **Depth:** 23 **Height:** 42.5
AH: 32 **SH:** 27 **SD:** 19 **IW:** 14
Weight: 24 lbs **Cube:** 11.87

D	E	F	G	H	J	K COM	L	M	N	O	P	Q	R	S	T	U	(# above U) *	S Nail	M Nail
N/A	N/A	N/A	N/A	N/A	N/A	N/A	N/A	N/A	N/A	N/A	N/A	N/A	N/A	N/A	N/A	N/A	N/A (Riser) + N/A (U)	N/A	N/A
Leather 1 1797		Leather 2 N/A		Leather 3 N/A		Leather 4 N/A		Leather 5 N/A		Leather 6 N/A		Leather 8 N/A		COL N/A		S Nail N/A		M Nail N/A	

Fabric SKU: **F620-20** Leather SKU: **N/A**
 READY-TO-SHIP UPHOLSTERY
Huntington Square Cocktail Ottoman

Standard Pillows: N/A **Finish Req:** N
Standard Cushions: N/A **Standard Finish:**
COM: N/A yards **COL:** N/A
 Married in 9810-72 Willow.

Width: 52 **Depth:** 52 **Height:** 18
AH: 0 **SH:** 0 **SD:** 0 **IW:** 0
Weight: 53 lbs **Cube:** 28.16

D	E	F	G	H	J	K COM	L	M	N	O	P	Q	R	S	T	U	(# above U) *	S Nail	M Nail
2097	N/A	N/A	N/A	N/A	N/A	N/A	N/A	N/A	N/A	N/A	N/A	N/A	N/A	N/A	N/A	N/A	N/A (Riser) + N/A (U)	N/A	N/A
Leather 1 N/A		Leather 2 N/A		Leather 3 N/A		Leather 4 N/A		Leather 5 N/A		Leather 6 N/A		Leather 8 N/A		COL N/A		S Nail N/A		M Nail N/A	

Fabric SKU: **F621-20** Leather SKU: **N/A**
 READY-TO-SHIP UPHOLSTERY
Huntington Rectangular Cocktail Ottoman

Standard Pillows: N/A **Finish Req:** N
Standard Cushions: N/A **Standard Finish:**
COM: N/A yards **COL:** N/A
 Married in 9810-72 Willow.

Width: 50 **Depth:** 30 **Height:** 18
AH: 0 **SH:** 0 **SD:** 0 **IW:** 0
Weight: 33 lbs **Cube:** 15.62

D	E	F	G	H	J	K COM	L	M	N	O	P	Q	R	S	T	U	(# above U) *	S Nail	M Nail
1647	N/A	N/A	N/A	N/A	N/A	N/A	N/A	N/A	N/A	N/A	N/A	N/A	N/A	N/A	N/A	N/A	N/A (Riser) + N/A (U)	N/A	N/A
Leather 1 N/A		Leather 2 N/A		Leather 3 N/A		Leather 4 N/A		Leather 5 N/A		Leather 6 N/A		Leather 8 N/A		COL N/A		S Nail N/A		M Nail N/A	

Fabric SKU: **F840-04-O** Leather SKU: **N/A**
 READY-TO-SHIP UPHOLSTERY
Lila Arm Chair

Standard Pillows: N/A **Finish Req:** N
Standard Cushions: High Resiliency 40 **Standard Finish:** Bavarian Cream
COM: N/A yards **COL:** N/A
 Married in Fabric 9953 Oyster with Bavarian Creme and gold striping. Standard two packed per box.

Width: 23.25 **Depth:** 24.5 **Height:** 39
AH: 24.25 **SH:** 19 **SD:** 18.5 **IW:** 23.75
Weight: 63 lbs **Cube:** 26.56

D	E	F	G	H	J	K COM	L	M	N	O	P	Q	R	S	T	U	(# above U) *	S Nail	M Nail
1320	N/A	N/A	N/A	N/A	N/A	N/A	N/A	N/A	N/A	N/A	N/A	N/A	N/A	N/A	N/A	N/A	N/A (Riser) + N/A (U)	N/A	N/A
Leather 1 N/A		Leather 2 N/A		Leather 3 N/A		Leather 4 N/A		Leather 5 N/A		Leather 6 N/A		Leather 8 N/A		COL N/A		S Nail N/A		M Nail N/A	

Fabric SKU: **F840-04-S** Leather SKU: **N/A**
 READY-TO-SHIP UPHOLSTERY
Lila Arm Chair

Standard Pillows: N/A **Finish Req:** N
Standard Cushions: High Resiliency 40 **Standard Finish:** Bavarian Cream
COM: N/A yards **COL:** N/A
 Married in 9953 Sand with Bavarian Creme finish and gold striping. Standard two packed per box.

Width: 23.25 **Depth:** 24.5 **Height:** 39
AH: 24.25 **SH:** 19 **SD:** 18.5 **IW:** 23.75
Weight: 63 lbs **Cube:** 26.56

D	E	F	G	H	J	K COM	L	M	N	O	P	Q	R	S	T	U	(# above U) *	S Nail	M Nail
1320	N/A	N/A	N/A	N/A	N/A	N/A	N/A	N/A	N/A	N/A	N/A	N/A	N/A	N/A	N/A	N/A	N/A (Riser) + N/A (U)	N/A	N/A
Leather 1 N/A		Leather 2 N/A		Leather 3 N/A		Leather 4 N/A		Leather 5 N/A		Leather 6 N/A		Leather 8 N/A		COL N/A		S Nail N/A		M Nail N/A	

Fabric SKU: **F840-05-O** Leather SKU: **N/A**
 READY-TO-SHIP UPHOLSTERY
Lila Side Chair

Standard Pillows: N/A **Finish Req:** N
Standard Cushions: High Resiliency 40 **Standard Finish:** Bavarian Cream
COM: N/A yards **COL:** N/A
 Married in 9953 Oyster with Bavarian Creme finish and gold striping. Standard two packed per box.

Width: 23.25 **Depth:** 24.5 **Height:** 39
AH: 0 **SH:** 19 **SD:** 18.5 **IW:** 23.75
Weight: 27 lbs **Cube:** 15.74

D	E	F	G	H	J	K COM	L	M	N	O	P	Q	R	S	T	U	(# above U) *	S Nail	M Nail
1197	N/A	N/A	N/A	N/A	N/A	N/A	N/A	N/A	N/A	N/A	N/A	N/A	N/A	N/A	N/A	N/A	N/A (Riser) + N/A (U)	N/A	N/A
Leather 1 N/A		Leather 2 N/A		Leather 3 N/A		Leather 4 N/A		Leather 5 N/A		Leather 6 N/A		Leather 8 N/A		COL N/A		S Nail N/A		M Nail N/A	

Upholstery

**Pillows are not available on leather SKUs*

Fabric SKU: **F842-04** Leather SKU: **N/A**
 READY-TO-SHIP UPHOLSTERY
Ava Arm Chair

Width: 22.5 **Depth:** 25.75 **Height:** 40.5
AH: 24.5 **SH:** 19.5 **SD:** 20 **IW:** 20
Weight: 70 lbs **Cube:** 17.77

Standard Pillows: N/A **Finish Req:** N
Standard Cushions: High Resiliency 40 **Standard Finish:** Almond Buff
COM: N/A yards **COL:** N/A
 Married in Fabric 8796 Alabaster with Almond Buff finish. Features natural cane accents that are handwoven using the peel of natural rattan. As with any natural product, nature's imperfections and hallmarks will be present in the cane materials. Cane is a handcrafted product dating back to the Ancient Egyptians. Standard two packed per box.

D	E	F	G	H	J	K COM	L	M	N	O	P	Q	R	S	T	U	(# above U) *	S Nail	M Nail
1320	N/A	N/A	N/A	N/A	N/A	N/A	N/A	N/A	N/A	N/A	N/A	N/A	N/A	N/A	N/A	N/A	N/A (Riser) + N/A (U)	N/A	N/A
Leather 1 N/A		Leather 2 N/A		Leather 3 N/A		Leather 4 N/A		Leather 5 N/A		Leather 6 N/A		Leather 8 N/A		COL N/A		S Nail N/A		M Nail N/A	

Fabric SKU: **F842-05** Leather SKU: **N/A**
 READY-TO-SHIP UPHOLSTERY
Ava Side Chair

Width: 22.5 **Depth:** 25.75 **Height:** 40.5
AH: 24.5 **SH:** 19.5 **SD:** 20 **IW:** 20
Weight: 72 lbs **Cube:** 17.77

Standard Pillows: N/A **Finish Req:** N
Standard Cushions: High Resiliency 40 **Standard Finish:** Almond Buff
COM: N/A yards **COL:** N/A
 Married in Fabric 8796 Alabaster with Almond Buff finish. Features natural cane accents that are handwoven using the peel of natural rattan. As with any natural product, nature's imperfections and hallmarks will be present in the cane materials. Cane is a handcrafted product dating back to the Ancient Egyptians. Standard two packed per box.

D	E	F	G	H	J	K COM	L	M	N	O	P	Q	R	S	T	U	(# above U) *	S Nail	M Nail
1197	N/A	N/A	N/A	N/A	N/A	N/A	N/A	N/A	N/A	N/A	N/A	N/A	N/A	N/A	N/A	N/A	N/A (Riser) + N/A (U)	N/A	N/A
Leather 1 N/A		Leather 2 N/A		Leather 3 N/A		Leather 4 N/A		Leather 5 N/A		Leather 6 N/A		Leather 8 N/A		COL N/A		S Nail N/A		M Nail N/A	

Fabric SKU: **F856-05-D** Leather SKU: **N/A**
 READY-TO-SHIP UPHOLSTERY
Parsons Side Chair

Width: 18.5 **Depth:** 24 **Height:** 41.25
AH: 0 **SH:** 19.5 **SD:** 17 **IW:** 18.5
Weight: 16 lbs **Cube:** 10.59

Standard Pillows: N/A **Finish Req:** N
Standard Cushions: High Resiliency 40 **Standard Finish:** Tobacco
COM: 2 yards **COL:** N/A
 Married in 7606 Denim with Tobacco Finish

D	E	F	G	H	J	K COM	L	M	N	O	P	Q	R	S	T	U	(# above U) *	S Nail	M Nail
855	N/A	N/A	N/A	N/A	N/A	N/A	N/A	N/A	N/A	N/A	N/A	N/A	N/A	N/A	N/A	N/A	N/A (Riser) + N/A (U)	N/A	N/A
Leather 1 N/A		Leather 2 N/A		Leather 3 N/A		Leather 4 N/A		Leather 5 N/A		Leather 6 N/A		Leather 8 N/A		COL N/A		S Nail N/A		M Nail N/A	

Fabric SKU: **F856-05-F** Leather SKU: **N/A**
 READY-TO-SHIP UPHOLSTERY
Parsons Side Chair

Width: 18.5 **Depth:** 24 **Height:** 41.25
AH: 0 **SH:** 19.5 **SD:** 17 **IW:** 18.5
Weight: 16 lbs **Cube:** 10.59

Standard Pillows: N/A **Finish Req:** N
Standard Cushions: High Resiliency 40 **Standard Finish:** Tobacco
COM: 2 yards **COL:** N/A
 Married in 7606 Flannel with Tobacco Finish

D	E	F	G	H	J	K COM	L	M	N	O	P	Q	R	S	T	U	(# above U) *	S Nail	M Nail
855	N/A	N/A	N/A	N/A	N/A	N/A	N/A	N/A	N/A	N/A	N/A	N/A	N/A	N/A	N/A	N/A	N/A (Riser) + N/A (U)	N/A	N/A
Leather 1 N/A		Leather 2 N/A		Leather 3 N/A		Leather 4 N/A		Leather 5 N/A		Leather 6 N/A		Leather 8 N/A		COL N/A		S Nail N/A		M Nail N/A	

Fabric SKU: **F856-05-S** Leather SKU: **N/A**
 READY-TO-SHIP UPHOLSTERY
Parsons Side Chair

Width: 18.5 **Depth:** 24 **Height:** 41.25
AH: 0 **SH:** 19.5 **SD:** 17 **IW:** 18.5
Weight: 16 lbs **Cube:** 10.59

Standard Pillows: N/A **Finish Req:** N
Standard Cushions: High Resiliency 40 **Standard Finish:** Tobacco
COM: 2 yards **COL:** N/A
 Married in 7606 Smoke with Tobacco Finish

D	E	F	G	H	J	K COM	L	M	N	O	P	Q	R	S	T	U	(# above U) *	S Nail	M Nail
855	N/A	N/A	N/A	N/A	N/A	N/A	N/A	N/A	N/A	N/A	N/A	N/A	N/A	N/A	N/A	N/A	N/A (Riser) + N/A (U)	N/A	N/A
Leather 1 N/A		Leather 2 N/A		Leather 3 N/A		Leather 4 N/A		Leather 5 N/A		Leather 6 N/A		Leather 8 N/A		COL N/A		S Nail N/A		M Nail N/A	

Fabric SKU: **F857-05-D** Leather SKU: **N/A**
 READY-TO-SHIP UPHOLSTERY
Lasso Side Chair

Width: 18.5 **Depth:** 24 **Height:** 41.25
AH: 0 **SH:** 19.5 **SD:** 17 **IW:** 18.5
Weight: 16 lbs **Cube:** 10.59

Standard Pillows: N/A **Finish Req:** N
Standard Cushions: High Resiliency 40 **Standard Finish:** Tobacco
COM: 2.25 yards **COL:** N/A
 Married in 7606 Denim with Tobacco Finish

D	E	F	G	H	J	K COM	L	M	N	O	P	Q	R	S	T	U	(# above U) *	S Nail	M Nail
855	N/A	N/A	N/A	N/A	N/A	N/A	N/A	N/A	N/A	N/A	N/A	N/A	N/A	N/A	N/A	N/A	N/A (Riser) + N/A (U)	N/A	N/A
Leather 1 N/A		Leather 2 N/A		Leather 3 N/A		Leather 4 N/A		Leather 5 N/A		Leather 6 N/A		Leather 8 N/A		COL N/A		S Nail N/A		M Nail N/A	

Upholstery

**Pillows are not available on leather SKUs*

Fabric SKU: **F857-05-F** Leather SKU: **N/A**
 READY-TO-SHIP UPHOLSTERY
Lasso Side Chair

Standard Pillows: N/A **Finish Req:** N
Standard Cushions: High Resiliency 40 **Standard Finish:** Tobacco
COM: 2.25 yards **COL:** N/A
 Married in 7606 Flannel with Tobacco Finish

Width: 18.5 **Depth:** 24 **Height:** 41.25
AH: 0 **SH:** 19.5 **SD:** 17 **IW:** 18.5
Weight: 16 lbs **Cube:** 10.59

D	E	F	G	H	J	K COM	L	M	N	O	P	Q	R	S	T	U	(# above U) *	S Nail	M Nail
855	N/A	N/A	N/A	N/A	N/A	N/A	N/A	N/A	N/A	N/A	N/A	N/A	N/A	N/A	N/A	N/A	N/A (Riser) + N/A (U)	N/A	N/A
Leather 1		Leather 2		Leather 3		Leather 4		Leather 5		Leather 6		Leather 8		COL		S Nail		M Nail	
N/A		N/A		N/A		N/A		N/A		N/A		N/A		N/A		N/A		N/A	

Fabric SKU: **F857-05-S** Leather SKU: **N/A**
 READY-TO-SHIP UPHOLSTERY
Lasso Side Chair

Standard Pillows: N/A **Finish Req:** N
Standard Cushions: High Resiliency 40 **Standard Finish:** Tobacco
COM: 2.25 yards **COL:** N/A
 Married in 7606 Smoke with Tobacco Finish

Width: 18.5 **Depth:** 24 **Height:** 41.25
AH: 0 **SH:** 19.5 **SD:** 17 **IW:** 18.5
Weight: 16 lbs **Cube:** 10.59

D	E	F	G	H	J	K COM	L	M	N	O	P	Q	R	S	T	U	(# above U) *	S Nail	M Nail
855	N/A	N/A	N/A	N/A	N/A	N/A	N/A	N/A	N/A	N/A	N/A	N/A	N/A	N/A	N/A	N/A	N/A (Riser) + N/A (U)	N/A	N/A
Leather 1		Leather 2		Leather 3		Leather 4		Leather 5		Leather 6		Leather 8		COL		S Nail		M Nail	
N/A		N/A		N/A		N/A		N/A		N/A		N/A		N/A		N/A		N/A	

Fabric SKU: **F857-05-V** Leather SKU: **N/A**
 READY-TO-SHIP UPHOLSTERY
Lasso Side Chair

Standard Pillows: N/A **Finish Req:** N
Standard Cushions: High Resiliency 40 **Standard Finish:** Tobacco
COM: 2.25 yards **COL:** N/A
 Married in 7606 Vapor with Tobacco Finish

Width: 18.5 **Depth:** 24 **Height:** 41.25
AH: 0 **SH:** 19.5 **SD:** 17 **IW:** 18.5
Weight: 16 lbs **Cube:** 10.59

D	E	F	G	H	J	K COM	L	M	N	O	P	Q	R	S	T	U	(# above U) *	S Nail	M Nail
855	N/A	N/A	N/A	N/A	N/A	N/A	N/A	N/A	N/A	N/A	N/A	N/A	N/A	N/A	N/A	N/A	N/A (Riser) + N/A (U)	N/A	N/A
Leather 1		Leather 2		Leather 3		Leather 4		Leather 5		Leather 6		Leather 8		COL		S Nail		M Nail	
N/A		N/A		N/A		N/A		N/A		N/A		N/A		N/A		N/A		N/A	

Fabric SKU: **FURR-Y1** Leather SKU: **N/A**
 FURRY COLLECTION
Furry Rectangular Ottoman

Standard Pillows: N/A **Finish Req:** N
Standard Cushions: High Resiliency 40 **Standard Finish:** Graphite
COM: 1.75 yards **COL:** N/A

Width: 30 **Depth:** 20 **Height:** 19
AH: 0 **SH:** 0 **SD:** 0 **IW:** 0
Weight: 15 lbs **Cube:** 10.77

D	E	F	G	H	J	K COM	L	M	N	O	P	Q	R	S	T	U	(# above U) *	S Nail	M Nail
630	636	642	648	654	660	666	672	678	684	690	696	702	708	714	720	726	6 (Riser) + 726 (U)	N/A	N/A
Leather 1		Leather 2		Leather 3		Leather 4		Leather 5		Leather 6		Leather 8		COL		S Nail		M Nail	
N/A		N/A		N/A		N/A		N/A		N/A		N/A		N/A		N/A		N/A	

Fabric SKU: **FURR-Y2** Leather SKU: **N/A**
 FURRY COLLECTION
Furry Round Ottoman

Standard Pillows: N/A **Finish Req:** N
Standard Cushions: High Resiliency 40 **Standard Finish:** Graphite
COM: 1.5 yards **COL:** N/A

Width: 20 **Depth:** 20 **Height:** 19.5
AH: 0 **SH:** 0 **SD:** 0 **IW:** 0
Weight: 12 lbs **Cube:** 10.77

D	E	F	G	H	J	K COM	L	M	N	O	P	Q	R	S	T	U	(# above U) *	S Nail	M Nail
630	636	642	648	654	660	666	672	678	684	690	696	702	708	714	720	726	6 (Riser) + 726 (U)	N/A	N/A
Leather 1		Leather 2		Leather 3		Leather 4		Leather 5		Leather 6		Leather 8		COL		S Nail		M Nail	
N/A		N/A		N/A		N/A		N/A		N/A		N/A		N/A		N/A		N/A	

Fabric SKU: **FURR-Y3** Leather SKU: **N/A**
 FURRY COLLECTION
Furry Ottoman

Standard Pillows: N/A **Finish Req:** N
Standard Cushions: High Resiliency 40 **Standard Finish:** Acrylic
COM: 2 yards **COL:** N/A

Width: 35 **Depth:** 12.25 **Height:** 18
AH: 0 **SH:** 18 **SD:** 0 **IW:** 0
Weight: 15 lbs **Cube:** 15.26

D	E	F	G	H	J	K COM	L	M	N	O	P	Q	R	S	T	U	(# above U) *	S Nail	M Nail
990	996	1002	1008	1014	1020	1026	1032	1038	1044	1050	1056	1062	1068	1074	1080	1086	6 (Riser) + 1086 (U)	N/A	N/A
Leather 1		Leather 2		Leather 3		Leather 4		Leather 5		Leather 6		Leather 8		COL		S Nail		M Nail	
N/A		N/A		N/A		N/A		N/A		N/A		N/A		N/A		N/A		N/A	

Upholstery

**Pillows are not available on leather SKUs*

Fabric SKU: **FURR-Y4-7**
 FURRY COLLECTION
Furry Round Ottoman

Leather SKU: **N/A**

Standard Pillows: N/A **Finish Req:** N
Standard Cushions: High Resiliency 40 **Standard Finish:** Bright Brass
COM: 1.25 yards **COL:** N/A

Width: 16.5 **Depth:** 16.5 **Height:** 17.5
AH: 0 **SH:** 0 **SD:** 0 **IW:** 0
Weight: 9 lbs **Cube:** 10.77

D	E	F	G	H	J	K ^{COM}	L	M	N	O	P	Q	R	S	T	U	(# above U) *	S Nail	M Nail
900	903	906	909	912	915	918	921	924	927	930	933	936	939	942	945	948	3 (Riser) + 948 (U)	N/A	N/A
Leather 1 N/A		Leather 2 N/A		Leather 3 N/A		Leather 4 N/A		Leather 5 N/A		Leather 6 N/A		Leather 8 N/A		COL N/A		S Nail N/A		M Nail N/A	

Fabric SKU: **M018-KB**
 MONOGRAM
Camille King Bed

Leather SKU: **N/A**

Standard Pillows: N/A **Finish Req:** Y
Standard Cushions: N/A **Standard Finish:**
COM: 3.75 yards **COL:** N/A

Width: 80 **Depth:** 84 **Height:** 60
AH: 0 **SH:** 0 **SD:** 0 **IW:** 0
Weight: 270 lbs **Cube:** 233.33

D	E	F	G	H	J	K ^{COM}	L	M	N	O	P	Q	R	S	T	U	(# above U) *	S Nail	M Nail
4947	4959	4971	4983	4995	5007	5019	5031	5043	5055	5067	5079	5091	5103	5115	5127	5139	12 (Riser) + 5139 (U)	N/A	N/A
Leather 1 N/A		Leather 2 N/A		Leather 3 N/A		Leather 4 N/A		Leather 5 N/A		Leather 6 N/A		Leather 8 N/A		COL N/A		S Nail N/A		M Nail N/A	

Fabric SKU: **M018-QB**
 MONOGRAM
Camille Queen Bed

Leather SKU: **N/A**

Standard Pillows: N/A **Finish Req:** Y
Standard Cushions: N/A **Standard Finish:**
COM: 3.5 yards **COL:** N/A

Width: 64 **Depth:** 84 **Height:** 60
AH: 0 **SH:** 0 **SD:** 0 **IW:** 0
Weight: 230 lbs **Cube:** 186.66

D	E	F	G	H	J	K ^{COM}	L	M	N	O	P	Q	R	S	T	U	(# above U) *	S Nail	M Nail
4797	4806	4815	4824	4833	4842	4851	4860	4869	4878	4887	4896	4905	4914	4923	4932	4941	9 (Riser) + 4941 (U)	N/A	N/A
Leather 1 N/A		Leather 2 N/A		Leather 3 N/A		Leather 4 N/A		Leather 5 N/A		Leather 6 N/A		Leather 8 N/A		COL N/A		S Nail N/A		M Nail N/A	

Fabric SKU: **M096-KB**
 MONOGRAM
West Camden King Bed

Leather SKU: **N/A**

Standard Pillows: N/A **Finish Req:** Y
Standard Cushions: N/A **Standard Finish:**
COM: 3.5 yards **COL:** N/A

Width: 81 **Depth:** 85.5 **Height:** 71
AH: 0 **SH:** 0 **SD:** 0 **IW:** 0
Weight: 330 lbs **Cube:** 284.55

D	E	F	G	H	J	K ^{COM}	L	M	N	O	P	Q	R	S	T	U	(# above U) *	S Nail	M Nail
4947	4959	4971	4983	4995	5007	5019	5031	5043	5055	5067	5079	5091	5103	5115	5127	5139	12 (Riser) + 5139 (U)	N/A	N/A
Leather 1 N/A		Leather 2 N/A		Leather 3 N/A		Leather 4 N/A		Leather 5 N/A		Leather 6 N/A		Leather 8 N/A		COL N/A		S Nail N/A		M Nail N/A	

Fabric SKU: **M096-KH**
 MONOGRAM
West Camden King Bed

Leather SKU: **L-M096-KH**

Standard Pillows: N/A **Finish Req:** Y
Standard Cushions: N/A **Standard Finish:**
COM: 3.5 yards **COL:** 62 square feet

Width: 81 **Depth:** 85.5 **Height:** 60
AH: 0 **SH:** 0 **SD:** 0 **IW:** 0
Weight: 300 lbs **Cube:** 240.46

D	E	F	G	H	J	K ^{COM}	L	M	N	O	P	Q	R	S	T	U	(# above U) *	S Nail	M Nail
4947	4959	4971	4983	4995	5007	5019	5031	5043	5055	5067	5079	5091	5103	5115	5127	5139	12 (Riser) + 5139 (U)	N/A	N/A
Leather 1 5697		Leather 2 5802		Leather 3 5907		Leather 4 6012		Leather 5 6117		Leather 6 6222		Leather 8 7077		COL 5043		S Nail N/A		M Nail N/A	

Fabric SKU: **M096-QB**
 MONOGRAM
West Camden Queen Bed

Leather SKU: **N/A**

Standard Pillows: N/A **Finish Req:** Y
Standard Cushions: N/A **Standard Finish:**
COM: 2.75 yards **COL:** N/A

Width: 65 **Depth:** 85.5 **Height:** 71
AH: 0 **SH:** 0 **SD:** 0 **IW:** 0
Weight: 300 lbs **Cube:** 228.34

D	E	F	G	H	J	K ^{COM}	L	M	N	O	P	Q	R	S	T	U	(# above U) *	S Nail	M Nail
4797	4806	4815	4824	4833	4842	4851	4860	4869	4878	4887	4896	4905	4914	4923	4932	4941	9 (Riser) + 4941 (U)	N/A	N/A
Leather 1 N/A		Leather 2 N/A		Leather 3 N/A		Leather 4 N/A		Leather 5 N/A		Leather 6 N/A		Leather 8 N/A		COL N/A		S Nail N/A		M Nail N/A	

Upholstery

**Pillows are not available on leather SKUs*

Fabric SKU: **M096-QH**
MONOGRAM
West Camden Queen Bed

Leather SKU: **L-M096-QH**

Standard Pillows: N/A **Finish Req:** Y
Standard Cushions: N/A **Standard Finish:**
COM: 2.75 yards **COL:** 51 square feet

Width: 65 **Depth:** 85.5 **Height:** 60
AH: 0 **SH:** 0 **SD:** 0 **IW:** 0
Weight: 280 lbs **Cube:** 192.96

D	E	F	G	H	J	K COM	L	M	N	O	P	Q	R	S	T	U	(# above U) *	S Nail	M Nail
4797	4806	4815	4824	4833	4842	4851	4860	4869	4878	4887	4896	4905	4914	4923	4932	4941	9 (Riser) + 4941 (U)	N/A	N/A
Leather 1 5547		Leather 2 5622		Leather 3 5697		Leather 4 5772		Leather 5 5847		Leather 6 5922		Leather 8 6627		COL 4869		S Nail N/A		M Nail N/A	

Fabric SKU: **M900-KB**
MONOGRAM
Shelby King Bed

Leather SKU: **L-M900-KB**

Standard Pillows: N/A **Finish Req:** Y
Standard Cushions: N/A **Standard Finish:**
COM: 7.25 yards **COL:** 113 square feet

Available in Monogram finishes only. This low profile bed is designed with a narrow foot-board & siderails to be used without a box-spring. This bed style is standard with a platform to support a conventional mattress.

Width: 80.75 **Depth:** 88 **Height:** 66
AH: 0 **SH:** 0 **SD:** 0 **IW:** 0
Weight: 175 lbs **Cube:** 63.7

D	E	F	G	H	J	K COM	L	M	N	O	P	Q	R	S	T	U	(# above U) *	S Nail	M Nail
4437	4458	4479	4500	4521	4542	4563	4584	4605	4626	4647	4668	4689	4710	4731	4752	4773	21 (Riser) + 4773 (U)	N/A	N/A
Leather 1 6840		Leather 2 7020		Leather 3 7200		Leather 4 7380		Leather 5 7560		Leather 6 7740		Leather 8 9300		COL 4605		S Nail N/A		M Nail N/A	

Fabric SKU: **M900-QB**
MONOGRAM
Shelby Queen Bed

Leather SKU: **L-M900-QB**

Standard Pillows: N/A **Finish Req:** Y
Standard Cushions: N/A **Standard Finish:**
COM: 5 yards **COL:** 96 square feet

Available in Monogram finishes only. This low profile bed is designed with a narrow footboard & siderails to be used without a box-spring. This bed style is standard with a platform to support a conventional mattress.

Width: 67.75 **Depth:** 88 **Height:** 66
AH: 0 **SH:** 0 **SD:** 0 **IW:** 0
Weight: 232 lbs **Cube:** 63.7

D	E	F	G	H	J	K COM	L	M	N	O	P	Q	R	S	T	U	(# above U) *	S Nail	M Nail
4287	4302	4317	4332	4347	4362	4377	4392	4407	4422	4437	4452	4467	4482	4497	4512	4527	15 (Riser) + 4527 (U)	N/A	N/A
Leather 1 6690		Leather 2 6840		Leather 3 6990		Leather 4 7140		Leather 5 7290		Leather 6 7440		Leather 8 8760		COL 4407		S Nail N/A		M Nail N/A	

Fabric SKU: **M901-KB**
MONOGRAM
Ackerly King Bed

Leather SKU: **L-M901-KB**

Standard Pillows: N/A **Finish Req:** Y
Standard Cushions: N/A **Standard Finish:**
COM: 6.75 yards **COL:** 141 square feet

Available in Monogram finishes only.

Width: 81 **Depth:** 84 **Height:** 66
AH: 0 **SH:** 0 **SD:** 0 **IW:** 0
Weight: 175 lbs **Cube:** 64.63

D	E	F	G	H	J	K COM	L	M	N	O	P	Q	R	S	T	U	(# above U) *	S Nail	M Nail
4437	4458	4479	4500	4521	4542	4563	4584	4605	4626	4647	4668	4689	4710	4731	4752	4773	21 (Riser) + 4773 (U)	N/A	N/A
Leather 1 6765		Leather 2 6975		Leather 3 7185		Leather 4 7395		Leather 5 7605		Leather 6 7815		Leather 8 9765		COL 4605		S Nail N/A		M Nail N/A	

Fabric SKU: **M901-QB**
MONOGRAM
Ackerly Queen Bed

Leather SKU: **L-M901-QB**

Standard Pillows: N/A **Finish Req:** Y
Standard Cushions: N/A **Standard Finish:**
COM: 4.5 yards **COL:** 119 square feet

Available in Monogram finishes only.

Width: 65 **Depth:** 84 **Height:** 66
AH: 0 **SH:** 0 **SD:** 0 **IW:** 0
Weight: 232 lbs **Cube:** 64.63

D	E	F	G	H	J	K COM	L	M	N	O	P	Q	R	S	T	U	(# above U) *	S Nail	M Nail
4287	4302	4317	4332	4347	4362	4377	4392	4407	4422	4437	4452	4467	4482	4497	4512	4527	15 (Riser) + 4527 (U)	N/A	N/A
Leather 1 6660		Leather 2 6840		Leather 3 7020		Leather 4 7200		Leather 5 7380		Leather 6 7560		Leather 8 9195		COL 4407		S Nail N/A		M Nail N/A	

Fabric SKU: **N077-01**
Sparta Lounge Chair

Leather SKU: **L-N077-01**

Standard Pillows: N/A **Finish Req:** N
Standard Cushions: High Resiliency 40 **Standard Finish:** Nickel
COM: 5.5 yards **COL:** 90.95 square feet

Only available in Nickel finish

Width: 30.5 **Depth:** 34.5 **Height:** 32
AH: 22 **SH:** 18 **SD:** 21 **IW:** 24
Weight: 60 lbs **Cube:** 29.69

D	E	F	G	H	J	K COM	L	M	N	O	P	Q	R	S	T	U	(# above U) *	S Nail	M Nail
2325	2340	2355	2370	2385	2400	2415	2430	2445	2460	2475	2490	2505	2520	2535	2550	2565	15 (Riser) + 2565 (U)	N/A	N/A
Leather 1 3360		Leather 2 3495		Leather 3 3630		Leather 4 3765		Leather 5 3900		Leather 6 4035		Leather 8 5295		COL 2445		S Nail N/A		M Nail N/A	

Upholstery

**Pillows are not available on leather SKUs*

Fabric SKU: **N078-01**

Leather SKU: **L-N078-01**

Standard Pillows: N/A **Finish Req:** N

Standard Cushions: High Resiliency 40 **Standard Finish:** Nickel

COM: 5.5 yards **COL:** 79 square feet

Only available in Nickel finish

Sparta Lounge Chair

Width: 30.5 **Depth:** 34.5 **Height:** 32

AH: 22 **SH:** 18 **SD:** 21 **IW:** 24

Weight: 60 lbs **Cube:** 29.69

D	E	F	G	H	J	K COM	L	M	N	O	P	Q	R	S	T	U	(# above U) *	S Nail	M Nail
2385	2400	2415	2430	2445	2460	2475	2490	2505	2520	2535	2550	2565	2580	2595	2610	2625	15 (Riser) + 2625 (U)	N/A	N/A
Leather 1 3465		Leather 2 3585		Leather 3 3705		Leather 4 3825		Leather 5 3945		Leather 6 4065		Leather 8 5160		COL 2505		S Nail N/A		M Nail N/A	

Fabric SKU: **N098-M7**

Leather SKU: **L-N098-M7**

Standard Pillows: N/A **Finish Req:** N

Standard Cushions: High Resiliency 40 **Standard Finish:** Nickel

COM: 1.75 yards **COL:** 28.8 square feet

Only available in Nickel finish with standard gas lift

Uma Billiard Bar Stool

Width: 21 **Depth:** 26 **Height:** 42.5

AH: 0 **SH:** 25.5 **SD:** 20 **IW:** 0

Weight: 36 lbs **Cube:** 24.14

D	E	F	G	H	J	K COM	L	M	N	O	P	Q	R	S	T	U	(# above U) *	S Nail	M Nail
2025	2031	2037	2043	2049	2055	2061	2067	2073	2079	2085	2091	2097	2103	2109	2115	2121	6 (Riser) + 2121 (U)	N/A	N/A
Leather 1 2475		Leather 2 2520		Leather 3 2565		Leather 4 2610		Leather 5 2655		Leather 6 2700		Leather 8 3105		COL 2073		S Nail N/A		M Nail N/A	

Fabric SKU: **N099-M7**

Leather SKU: **L-N099-M7**

Standard Pillows: N/A **Finish Req:** N

Standard Cushions: High Resiliency 40 **Standard Finish:** Nickel

COM: 1.75 yards **COL:** 28.8 square feet

Only available in Nickel finish with standard gas lift

Uma Billiard Bar Stool

Width: 21 **Depth:** 26 **Height:** 42.5

AH: 0 **SH:** 25.5 **SD:** 20 **IW:** 0

Weight: 36 lbs **Cube:** 21.65

D	E	F	G	H	J	K COM	L	M	N	O	P	Q	R	S	T	U	(# above U) *	S Nail	M Nail
2100	2106	2112	2118	2124	2130	2136	2142	2148	2154	2160	2166	2172	2178	2184	2190	2196	6 (Riser) + 2196 (U)	N/A	N/A
Leather 1 2595		Leather 2 2640		Leather 3 2685		Leather 4 2730		Leather 5 2775		Leather 6 2820		Leather 8 3225		COL 2148		S Nail N/A		M Nail N/A	

Fabric SKU: **NIMB-26**

Leather SKU: **N/A**

Standard Pillows: N/A **Finish Req:** N

Standard Cushions: Blendown **Standard Finish:** Contemporary

COM: 15.5 yards **COL:** N/A

Original Right Arm Facing Chaise

Width: 43.5 **Depth:** 80 **Height:** 39

AH: 27 **SH:** 22 **SD:** 60.5 **IW:** 34

Weight: 111 lbs **Cube:** 78.54

D	E	F	G	H	J	K COM	L	M	N	O	P	Q	R	S	T	U	(# above U) *	S Nail	M Nail
4110	4152	4194	4236	4278	4320	4362	4404	4446	4488	4530	4572	4614	4656	4698	4740	4782	42 (Riser) + 4782 (U)	N/A	N/A
Leather 1 N/A		Leather 2 N/A		Leather 3 N/A		Leather 4 N/A		Leather 5 N/A		Leather 6 N/A		Leather 8 N/A		COL N/A		S Nail N/A		M Nail N/A	

Fabric SKU: **NIMB-27**

Leather SKU: **N/A**

Standard Pillows: N/A **Finish Req:** N

Standard Cushions: Blendown **Standard Finish:** Contemporary

COM: 15.5 yards **COL:** N/A

Original Left Arm Facing Chaise

Width: 43.5 **Depth:** 80 **Height:** 39

AH: 27 **SH:** 22 **SD:** 60.5 **IW:** 34

Weight: 111 lbs **Cube:** 92.4

D	E	F	G	H	J	K COM	L	M	N	O	P	Q	R	S	T	U	(# above U) *	S Nail	M Nail
4110	4152	4194	4236	4278	4320	4362	4404	4446	4488	4530	4572	4614	4656	4698	4740	4782	42 (Riser) + 4782 (U)	N/A	N/A
Leather 1 N/A		Leather 2 N/A		Leather 3 N/A		Leather 4 N/A		Leather 5 N/A		Leather 6 N/A		Leather 8 N/A		COL N/A		S Nail N/A		M Nail N/A	

Fabric SKU: **NIMB-29**

Leather SKU: **N/A**

Standard Pillows: N/A **Finish Req:** N

Standard Cushions: Blendown **Standard Finish:** Contemporary

COM: 10.75 yards **COL:** N/A

Nimbus Original Corner Chair

Width: 40.5 **Depth:** 40.5 **Height:** 39

AH: 27 **SH:** 22 **SD:** 21 **IW:** 21

Weight: 80 lbs **Cube:** 42.09

D	E	F	G	H	J	K COM	L	M	N	O	P	Q	R	S	T	U	(# above U) *	S Nail	M Nail
2850	2880	2910	2940	2970	3000	3030	3060	3090	3120	3150	3180	3210	3240	3270	3300	3330	30 (Riser) + 3330 (U)	N/A	N/A
Leather 1 N/A		Leather 2 N/A		Leather 3 N/A		Leather 4 N/A		Leather 5 N/A		Leather 6 N/A		Leather 8 N/A		COL N/A		S Nail N/A		M Nail N/A	

Upholstery

**Pillows are not available on leather SKUs*

Fabric SKU: **NIMB-51** Leather SKU: **N/A**

NIMBUS

Nimbus Original Right Arm Facing Sofa

Standard Pillows: N/A **Finish Req:** N

Standard Cushions: Blendown **Standard Finish:** Contemporary

COM: 19 yards **COL:** N/A

Width: 77.5 **Depth:** 40.5 **Height:** 39

AH: 27 **SH:** 22 **SD:** 21 **IW:** 58

Weight: 109 lbs **Cube:** 73.53

D 4275	E 4329	F 4383	G 4437	H 4491	J 4545	K COM 4599	L 4653	M 4707	N 4761	O 4815	P 4869	Q 4923	R 4977	S 5031	T 5085	U 5139	(# above U) * 54 (Riser) + 5139 (U)	S Nail N/A	M Nail N/A
Leather 1 N/A		Leather 2 N/A		Leather 3 N/A		Leather 4 N/A		Leather 5 N/A		Leather 6 N/A		Leather 8 N/A		COL N/A		S Nail N/A		M Nail N/A	

Fabric SKU: **NIMB-52** Leather SKU: **N/A**

NIMBUS

Nimbus Original Left Arm Facing Sofa

Standard Pillows: N/A **Finish Req:** N

Standard Cushions: Blendown **Standard Finish:** Contemporary

COM: 19 yards **COL:** N/A

Width: 77.5 **Depth:** 40.5 **Height:** 39

AH: 27 **SH:** 22 **SD:** 21 **IW:** 58

Weight: 109 lbs **Cube:** 73.53

D 4275	E 4329	F 4383	G 4437	H 4491	J 4545	K COM 4599	L 4653	M 4707	N 4761	O 4815	P 4869	Q 4923	R 4977	S 5031	T 5085	U 5139	(# above U) * 54 (Riser) + 5139 (U)	S Nail N/A	M Nail N/A
Leather 1 N/A		Leather 2 N/A		Leather 3 N/A		Leather 4 N/A		Leather 5 N/A		Leather 6 N/A		Leather 8 N/A		COL N/A		S Nail N/A		M Nail N/A	

Fabric SKU: **NIMB-53** Leather SKU: **N/A**

NIMBUS

Nimbus Original Right Arm Facing Corner Sofa

Standard Pillows: N/A **Finish Req:** N

Standard Cushions: Blendown **Standard Finish:** Contemporary

COM: 28.75 yards **COL:** N/A

Width: 118 **Depth:** 40.5 **Height:** 39

AH: 27 **SH:** 22 **SD:** 21 **IW:** 98

Weight: 139 lbs **Cube:** 112.18

D 5850	E 5928	F 6006	G 6084	H 6162	J 6240	K COM 6318	L 6396	M 6474	N 6552	O 6630	P 6708	Q 6786	R 6864	S 6942	T 7020	U 7098	(# above U) * 78 (Riser) + 7098 (U)	S Nail N/A	M Nail N/A
Leather 1 N/A		Leather 2 N/A		Leather 3 N/A		Leather 4 N/A		Leather 5 N/A		Leather 6 N/A		Leather 8 N/A		COL N/A		S Nail N/A		M Nail N/A	

Fabric SKU: **NIMB-54** Leather SKU: **N/A**

NIMBUS

Nimbus Original Left Arm Facing Corner Sofa

Standard Pillows: N/A **Finish Req:** N

Standard Cushions: Blendown **Standard Finish:** Contemporary

COM: 28.75 yards **COL:** N/A

Width: 118 **Depth:** 40.5 **Height:** 39

AH: 27 **SH:** 22 **SD:** 21 **IW:** 98

Weight: 248 lbs **Cube:** 112.18

D 5850	E 5928	F 6006	G 6084	H 6162	J 6240	K COM 6318	L 6396	M 6474	N 6552	O 6630	P 6708	Q 6786	R 6864	S 6942	T 7020	U 7098	(# above U) * 78 (Riser) + 7098 (U)	S Nail N/A	M Nail N/A
Leather 1 N/A		Leather 2 N/A		Leather 3 N/A		Leather 4 N/A		Leather 5 N/A		Leather 6 N/A		Leather 8 N/A		COL N/A		S Nail N/A		M Nail N/A	

Fabric SKU: **NIMB-56** Leather SKU: **N/A**

NIMBUS

Nimbus Original Extra Long Sofa

Standard Pillows: N/A **Finish Req:** N

Standard Cushions: Blendown **Standard Finish:** Contemporary

COM: 21 yards **COL:** N/A

Width: 97 **Depth:** 40.5 **Height:** 39

AH: 27 **SH:** 22 **SD:** 21 **IW:** 78

Weight: 153 lbs **Cube:** 82.92

D 5025	E 5082	F 5139	G 5196	H 5253	J 5310	K COM 5367	L 5424	M 5481	N 5538	O 5595	P 5652	Q 5709	R 5766	S 5823	T 5880	U 5937	(# above U) * 57 (Riser) + 5937 (U)	S Nail N/A	M Nail N/A
Leather 1 N/A		Leather 2 N/A		Leather 3 N/A		Leather 4 N/A		Leather 5 N/A		Leather 6 N/A		Leather 8 N/A		COL N/A		S Nail N/A		M Nail N/A	

Fabric SKU: **NIMB-58** Leather SKU: **N/A**

NIMBUS

Nimbus Original Armless Sofa

Standard Pillows: N/A **Finish Req:** N

Standard Cushions: Blendown **Standard Finish:** Contemporary

COM: 17.5 yards **COL:** N/A

Width: 68 **Depth:** 40.5 **Height:** 39

AH: 0 **SH:** 22 **SD:** 21 **IW:** 0

Weight: 121 lbs **Cube:** 62.15

D 4275	E 4323	F 4371	G 4419	H 4467	J 4515	K COM 4563	L 4611	M 4659	N 4707	O 4755	P 4803	Q 4851	R 4899	S 4947	T 4995	U 5043	(# above U) * 48 (Riser) + 5043 (U)	S Nail N/A	M Nail N/A
Leather 1 N/A		Leather 2 N/A		Leather 3 N/A		Leather 4 N/A		Leather 5 N/A		Leather 6 N/A		Leather 8 N/A		COL N/A		S Nail N/A		M Nail N/A	

Upholstery

**Pillows are not available on leather SKUs*

Fabric SKU: **NIMB-67** Leather SKU: **N/A**

NIMBUS

Nimbus Original Bumper Ottoman

Standard Pillows: N/A **Finish Req:** N

Standard Cushions: Blendown **Standard Finish:** Contemporary

COM: 6.75 yards **COL:** N/A

Width: 35 **Depth:** 40.5 **Height:** 22

AH: 0 **SH:** 22 **SD:** 40.5 **IW:** 35

Weight: 20 lbs **Cube:** 24.88

D 1725	E 1743	F 1761	G 1779	H 1797	J 1815	K COM 1833	L 1851	M 1869	N 1887	O 1905	P 1923	Q 1941	R 1959	S 1977	T 1995	U 2013	(# above U) * 18 (Riser) + 2013 (U)	S Nail N/A	M Nail N/A
Leather 1 N/A		Leather 2 N/A		Leather 3 N/A		Leather 4 N/A		Leather 5 N/A		Leather 6 N/A		Leather 8 N/A		COL N/A		S Nail N/A		M Nail N/A	

Fabric SKU: **NIMB-78** Leather SKU: **N/A**

NIMBUS

Nimbus Original Armless Chair

Standard Pillows: N/A **Finish Req:** N

Standard Cushions: Blendown **Standard Finish:** Contemporary

COM: 9.5 yards **COL:** N/A

Width: 35 **Depth:** 40.5 **Height:** 39

AH: 0 **SH:** 22 **SD:** 21 **IW:** 35

Weight: 65 lbs **Cube:** 31.01

D 2355	E 2385	F 2415	G 2445	H 2475	J 2505	K COM 2535	L 2565	M 2595	N 2625	O 2655	P 2685	Q 2715	R 2745	S 2775	T 2805	U 2835	(# above U) * 30 (Riser) + 2835 (U)	S Nail N/A	M Nail N/A
Leather 1 N/A		Leather 2 N/A		Leather 3 N/A		Leather 4 N/A		Leather 5 N/A		Leather 6 N/A		Leather 8 N/A		COL N/A		S Nail N/A		M Nail N/A	

Fabric SKU: **NIMP-26** Leather SKU: **N/A**

NIMBUS

Nimbus Petite Right Arm Facing Chaise

Standard Pillows: N/A **Finish Req:** N

Standard Cushions: Blendown **Standard Finish:** Contemporary

COM: 15.25 yards **COL:** N/A

Width: 40 **Depth:** 76 **Height:** 39

AH: 27 **SH:** 22 **SD:** 64 **IW:** 27

Weight: 111 lbs **Cube:** 68.61

D 4050	E 4092	F 4134	G 4176	H 4218	J 4260	K COM 4302	L 4344	M 4386	N 4428	O 4470	P 4512	Q 4554	R 4596	S 4638	T 4680	U 4722	(# above U) * 42 (Riser) + 4722 (U)	S Nail N/A	M Nail N/A
Leather 1 N/A		Leather 2 N/A		Leather 3 N/A		Leather 4 N/A		Leather 5 N/A		Leather 6 N/A		Leather 8 N/A		COL N/A		S Nail N/A		M Nail N/A	

Fabric SKU: **NIMP-27** Leather SKU: **N/A**

NIMBUS

Nimbus Petite Left Arm Facing Chaise

Standard Pillows: N/A **Finish Req:** N

Standard Cushions: Blendown **Standard Finish:** Contemporary

COM: 15.25 yards **COL:** N/A

Width: 40 **Depth:** 76 **Height:** 39

AH: 27 **SH:** 22 **SD:** 64 **IW:** 27

Weight: 111 lbs **Cube:** 70.78

D 4050	E 4092	F 4134	G 4176	H 4218	J 4260	K COM 4302	L 4344	M 4386	N 4428	O 4470	P 4512	Q 4554	R 4596	S 4638	T 4680	U 4722	(# above U) * 42 (Riser) + 4722 (U)	S Nail N/A	M Nail N/A
Leather 1 N/A		Leather 2 N/A		Leather 3 N/A		Leather 4 N/A		Leather 5 N/A		Leather 6 N/A		Leather 8 N/A		COL N/A		S Nail N/A		M Nail N/A	

Fabric SKU: **NIMP-29** Leather SKU: **N/A**

NIMBUS

Nimbus Petite Corner Chair

Standard Pillows: N/A **Finish Req:** N

Standard Cushions: Blendown **Standard Finish:** Contemporary

COM: 11 yards **COL:** N/A

Width: 35.5 **Depth:** 35.5 **Height:** 39

AH: 27 **SH:** 22 **SD:** 21 **IW:** 21

Weight: 65 lbs **Cube:** 24.88

D 2685	E 2715	F 2745	G 2775	H 2805	J 2835	K COM 2865	L 2895	M 2925	N 2955	O 2985	P 3015	Q 3045	R 3075	S 3105	T 3135	U 3165	(# above U) * 30 (Riser) + 3165 (U)	S Nail N/A	M Nail N/A
Leather 1 N/A		Leather 2 N/A		Leather 3 N/A		Leather 4 N/A		Leather 5 N/A		Leather 6 N/A		Leather 8 N/A		COL N/A		S Nail N/A		M Nail N/A	

Fabric SKU: **NIMP-51** Leather SKU: **N/A**

NIMBUS

Nimbus Petite Right Arm Facing Sofa

Standard Pillows: N/A **Finish Req:** N

Standard Cushions: Blendown **Standard Finish:** Contemporary

COM: 18.75 yards **COL:** N/A

Width: 72.5 **Depth:** 35.5 **Height:** 39

AH: 27 **SH:** 22 **SD:** 21 **IW:** 58

Weight: 118 lbs **Cube:** 70.78

D 4125	E 4179	F 4233	G 4287	H 4341	J 4395	K COM 4449	L 4503	M 4557	N 4611	O 4665	P 4719	Q 4773	R 4827	S 4881	T 4935	U 4989	(# above U) * 54 (Riser) + 4989 (U)	S Nail N/A	M Nail N/A
Leather 1 N/A		Leather 2 N/A		Leather 3 N/A		Leather 4 N/A		Leather 5 N/A		Leather 6 N/A		Leather 8 N/A		COL N/A		S Nail N/A		M Nail N/A	

Upholstery

**Pillows are not available on leather SKUs*

Fabric SKU: **NIMP-52** Leather SKU: **N/A**

NIMBUS

Nimbus Petite Left Arm Facing Sofa

Standard Pillows: N/A Finish Req: N

Standard Cushions: Blendown Standard Finish: Contemporary

COM: 18.75 yards COL: N/A

Width: 72.5 Depth: 35.5 Height: 39

AH: 27 SH: 22 SD: 21 IW: 58

Weight: 118 lbs Cube: 70.78

D	E	F	G	H	J	K COM	L	M	N	O	P	Q	R	S	T	U	(# above U) *	S Nail	M Nail
4125	4179	4233	4287	4341	4395	4449	4503	4557	4611	4665	4719	4773	4827	4881	4935	4989	54 (Riser) + 4989 (U)	N/A	N/A
Leather 1		Leather 2		Leather 3		Leather 4		Leather 5		Leather 6		Leather 8		COL		S Nail		M Nail	
N/A		N/A		N/A		N/A		N/A		N/A		N/A		N/A		N/A		N/A	

Fabric SKU: **NIMP-53** Leather SKU: **N/A**

NIMBUS

Nimbus Petite Right Arm Facing Corner Sofa

Standard Pillows: N/A Finish Req: N

Standard Cushions: Blendown Standard Finish: Contemporary

COM: 28.5 yards COL: N/A

Width: 108 Depth: 35.5 Height: 39

AH: 27 SH: 22 SD: 21 IW: 98

Weight: 220 lbs Cube: 81.85

D	E	F	G	H	J	K COM	L	M	N	O	P	Q	R	S	T	U	(# above U) *	S Nail	M Nail
5550	5628	5706	5784	5862	5940	6018	6096	6174	6252	6330	6408	6486	6564	6642	6720	6798	78 (Riser) + 6798 (U)	N/A	N/A
Leather 1		Leather 2		Leather 3		Leather 4		Leather 5		Leather 6		Leather 8		COL		S Nail		M Nail	
N/A		N/A		N/A		N/A		N/A		N/A		N/A		N/A		N/A		N/A	

Fabric SKU: **NIMP-54** Leather SKU: **N/A**

NIMBUS

Nimbus Petite Left Arm Facing Corner Sofa

Standard Pillows: N/A Finish Req: N

Standard Cushions: Blendown Standard Finish: Contemporary

COM: 28.5 yards COL: N/A

Width: 108 Depth: 35.5 Height: 39

AH: 27 SH: 22 SD: 21 IW: 98

Weight: 220 lbs Cube: 81.85

D	E	F	G	H	J	K COM	L	M	N	O	P	Q	R	S	T	U	(# above U) *	S Nail	M Nail
5550	5628	5706	5784	5862	5940	6018	6096	6174	6252	6330	6408	6486	6564	6642	6720	6798	78 (Riser) + 6798 (U)	N/A	N/A
Leather 1		Leather 2		Leather 3		Leather 4		Leather 5		Leather 6		Leather 8		COL		S Nail		M Nail	
N/A		N/A		N/A		N/A		N/A		N/A		N/A		N/A		N/A		N/A	

Fabric SKU: **NIMP-56** Leather SKU: **N/A**

NIMBUS

Nimbus Petite Extra Long Sofa

Standard Pillows: N/A Finish Req: N

Standard Cushions: Blendown Standard Finish: Contemporary

COM: 20.5 yards COL: N/A

Width: 87 Depth: 35.5 Height: 39

AH: 27 SH: 22 SD: 21 IW: 78

Weight: 125 lbs Cube: 79.34

D	E	F	G	H	J	K COM	L	M	N	O	P	Q	R	S	T	U	(# above U) *	S Nail	M Nail
5085	5142	5199	5256	5313	5370	5427	5484	5541	5598	5655	5712	5769	5826	5883	5940	5997	57 (Riser) + 5997 (U)	N/A	N/A
Leather 1		Leather 2		Leather 3		Leather 4		Leather 5		Leather 6		Leather 8		COL		S Nail		M Nail	
N/A		N/A		N/A		N/A		N/A		N/A		N/A		N/A		N/A		N/A	

Fabric SKU: **NIMP-58** Leather SKU: **N/A**

NIMBUS

Nimbus Petite Armless Sofa

Standard Pillows: N/A Finish Req: N

Standard Cushions: Blendown Standard Finish: Contemporary

COM: 17.25 yards COL: N/A

Width: 68 Depth: 35.5 Height: 39

AH: 0 SH: 22 SD: 21 IW: 68

Weight: 121 lbs Cube: 59.39

D	E	F	G	H	J	K COM	L	M	N	O	P	Q	R	S	T	U	(# above U) *	S Nail	M Nail
4050	4098	4146	4194	4242	4290	4338	4386	4434	4482	4530	4578	4626	4674	4722	4770	4818	48 (Riser) + 4818 (U)	N/A	N/A
Leather 1		Leather 2		Leather 3		Leather 4		Leather 5		Leather 6		Leather 8		COL		S Nail		M Nail	
N/A		N/A		N/A		N/A		N/A		N/A		N/A		N/A		N/A		N/A	

Fabric SKU: **NIMP-67** Leather SKU: **N/A**

NIMBUS

Nimbus Petite Bumper Ottoman

Standard Pillows: N/A Finish Req: N

Standard Cushions: Blendown Standard Finish: Contemporary

COM: 6.25 yards COL: N/A

Width: 34.5 Depth: 35.5 Height: 22

AH: 0 SH: 0 SD: 0 IW: 0

Weight: 30 lbs Cube: 21.15

D	E	F	G	H	J	K COM	L	M	N	O	P	Q	R	S	T	U	(# above U) *	S Nail	M Nail
1650	1668	1686	1704	1722	1740	1758	1776	1794	1812	1830	1848	1866	1884	1902	1920	1938	18 (Riser) + 1938 (U)	N/A	N/A
Leather 1		Leather 2		Leather 3		Leather 4		Leather 5		Leather 6		Leather 8		COL		S Nail		M Nail	
N/A		N/A		N/A		N/A		N/A		N/A		N/A		N/A		N/A		N/A	

Upholstery

**Pillows are not available on leather SKUs*

Fabric SKU: **NIMP-78** Leather SKU: **N/A**

NIMBUS
Nimbus Petite Armless Chair

Standard Pillows: N/A **Finish Req:** N
Standard Cushions: Blendown **Standard Finish:** Contemporary
COM: 9.25 yards **COL:** N/A

Width: 35 **Depth:** 35.5 **Height:** 39

AH: 0 **SH:** 22 **SD:** 21 **IW:** 35

Weight: 65 lbs **Cube:** 24.88

D 2250	E 2277	F 2304	G 2331	H 2358	J 2385	K COM 2412	L 2439	M 2466	N 2493	O 2520	P 2547	Q 2574	R 2601	S 2628	T 2655	U 2682	(# above U) * 27 (Riser) + 2682 (U)	S Nail N/A	M Nail N/A
Leather 1 N/A		Leather 2 N/A		Leather 3 N/A		Leather 4 N/A		Leather 5 N/A		Leather 6 N/A		Leather 8 N/A		COL N/A		S Nail N/A		M Nail N/A	

Fabric SKU: **NIMS-01** Leather SKU: **N/A**

NIMBUS
Nimbus Swag Lounge Chair

Standard Pillows: N/A **Finish Req:** N
Standard Cushions: Blendown **Standard Finish:** Contemporary
COM: 9.5 yards **COL:** N/A

Width: 34 **Depth:** 42.5 **Height:** 42.5

AH: 25 **SH:** 21 **SD:** 22 **IW:** 22

Weight: 50 lbs **Cube:** 36.49

D 3045	E 3072	F 3099	G 3126	H 3153	J 3180	K COM 3207	L 3234	M 3261	N 3288	O 3315	P 3342	Q 3369	R 3396	S 3423	T 3450	U 3477	(# above U) * 27 (Riser) + 3477 (U)	S Nail N/A	M Nail N/A
Leather 1 N/A		Leather 2 N/A		Leather 3 N/A		Leather 4 N/A		Leather 5 N/A		Leather 6 N/A		Leather 8 N/A		COL N/A		S Nail N/A		M Nail N/A	

Fabric SKU: **NIMS-20** Leather SKU: **N/A**

NIMBUS
Nimbus Swag Ottoman

Standard Pillows: N/A **Finish Req:** N
Standard Cushions: Blendown **Standard Finish:** Contemporary
COM: 2.75 yards **COL:** N/A

Width: 28 **Depth:** 25 **Height:** 17

AH: 0 **SH:** 17 **SD:** 28 **IW:** 25

Weight: 28 lbs **Cube:** 13.69

D 930	E 939	F 948	G 957	H 966	J 975	K COM 984	L 993	M 1002	N 1011	O 1020	P 1029	Q 1038	R 1047	S 1056	T 1065	U 1074	(# above U) * 9 (Riser) + 1074 (U)	S Nail N/A	M Nail N/A
Leather 1 N/A		Leather 2 N/A		Leather 3 N/A		Leather 4 N/A		Leather 5 N/A		Leather 6 N/A		Leather 8 N/A		COL N/A		S Nail N/A		M Nail N/A	

Fabric SKU: **NIMS-26** Leather SKU: **N/A**

NIMBUS
Swag Right Arm Facing Chaise

Standard Pillows: (1) 20 x 20, (1) 22 x 22 **Finish Req:** N
Standard Cushions: Blendown **Standard Finish:** Contemporary
COM: 15.5 yards **COL:** N/A

Width: 40 **Depth:** 81.5 **Height:** 42.5

AH: 25 **SH:** 21 **SD:** 61.5 **IW:** 35

Weight: 111 lbs **Cube:** 80.17

D 4275	E 4320	F 4365	G 4410	H 4455	J 4500	K COM 4545	L 4590	M 4635	N 4680	O 4725	P 4770	Q 4815	R 4860	S 4905	T 4950	U 4995	(# above U) * 45 (Riser) + 4995 (U)	S Nail N/A	M Nail N/A
Leather 1 N/A		Leather 2 N/A		Leather 3 N/A		Leather 4 N/A		Leather 5 N/A		Leather 6 N/A		Leather 8 N/A		COL N/A		S Nail N/A		M Nail N/A	

Fabric SKU: **NIMS-27** Leather SKU: **N/A**

NIMBUS
Swag Left Arm Facing Chaise

Standard Pillows: (1) 20 x 20, (1) 22 x 22 **Finish Req:** N
Standard Cushions: Blendown **Standard Finish:** Contemporary
COM: 15.5 yards **COL:** N/A

Width: 40 **Depth:** 81.5 **Height:** 42.5

AH: 25 **SH:** 21 **SD:** 61.5 **IW:** 35

Weight: 111 lbs **Cube:** 80.17

D 4275	E 4320	F 4365	G 4410	H 4455	J 4500	K COM 4545	L 4590	M 4635	N 4680	O 4725	P 4770	Q 4815	R 4860	S 4905	T 4950	U 4995	(# above U) * 45 (Riser) + 4995 (U)	S Nail N/A	M Nail N/A
Leather 1 N/A		Leather 2 N/A		Leather 3 N/A		Leather 4 N/A		Leather 5 N/A		Leather 6 N/A		Leather 8 N/A		COL N/A		S Nail N/A		M Nail N/A	

Fabric SKU: **NIMS-29** Leather SKU: **N/A**

NIMBUS
Nimbus Swag Corner Chair

Standard Pillows: (2) 22 x 22 **Finish Req:** N
Standard Cushions: Blendown **Standard Finish:** Contemporary
COM: 13.75 yards **COL:** N/A

Width: 43.5 **Depth:** 44.5 **Height:** 42.5

AH: 0 **SH:** 21 **SD:** 24 **IW:** 24

Weight: 65 lbs **Cube:** 47.6

D 3225	E 3264	F 3303	G 3342	H 3381	J 3420	K COM 3459	L 3498	M 3537	N 3576	O 3615	P 3654	Q 3693	R 3732	S 3771	T 3810	U 3849	(# above U) * 39 (Riser) + 3849 (U)	S Nail N/A	M Nail N/A
Leather 1 N/A		Leather 2 N/A		Leather 3 N/A		Leather 4 N/A		Leather 5 N/A		Leather 6 N/A		Leather 8 N/A		COL N/A		S Nail N/A		M Nail N/A	

Upholstery

**Pillows are not available on leather SKUs*

Fabric SKU: **NIMS-31** Leather SKU: **N/A**
 NIMBUS
Nimbus Swag Swivel Chair

Standard Pillows: N/A **Finish Req:** N
Standard Cushions: Blendown **Standard Finish:** Contemporary
COM: 9.5 yards **COL:** N/A

Width: 34 **Depth:** 42.5 **Height:** 42.5
AH: 25 **SH:** 21 **SD:** 22 **IW:** 22
Weight: 50 lbs **Cube:** 21.15

D	E	F	G	H	J	K COM	L	M	N	O	P	Q	R	S	T	U	(# above U) *	S Nail	M Nail
3120	3147	3174	3201	3228	3255	3282	3309	3336	3363	3390	3417	3444	3471	3498	3525	3552	27 (Riser) + 3552 (U)	N/A	N/A
Leather 1 N/A		Leather 2 N/A		Leather 3 N/A		Leather 4 N/A		Leather 5 N/A		Leather 6 N/A		Leather 8 N/A		COL N/A		S Nail N/A		M Nail N/A	

Fabric SKU: **NIMS-50** Leather SKU: **N/A**
 NIMBUS
Nimbus Swag Sofa

Standard Pillows: (2) 20 x 20 (2) 22 x 22 **Finish Req:** N
Standard Cushions: Blendown **Standard Finish:** Contemporary
COM: 23.75 yards **COL:** N/A

Width: 90 **Depth:** 44.5 **Height:** 42.5
AH: 25 **SH:** 21 **SD:** 24 **IW:** 78.5
Weight: 220 lbs **Cube:** 102.13

D	E	F	G	H	J	K COM	L	M	N	O	P	Q	R	S	T	U	(# above U) *	S Nail	M Nail
5625	5691	5757	5823	5889	5955	6021	6087	6153	6219	6285	6351	6417	6483	6549	6615	6681	66 (Riser) + 6681 (U)	N/A	N/A
Leather 1 N/A		Leather 2 N/A		Leather 3 N/A		Leather 4 N/A		Leather 5 N/A		Leather 6 N/A		Leather 8 N/A		COL N/A		S Nail N/A		M Nail N/A	

Fabric SKU: **NIMS-51** Leather SKU: **N/A**
 NIMBUS
Nimbus Swag Right Arm Facing Sofa

Standard Pillows: (1) 20 x 20 (1) 22 x 22 **Finish Req:** N
Standard Cushions: Blendown **Standard Finish:** Contemporary
COM: 20.5 yards **COL:** N/A

Width: 73.5 **Depth:** 44.5 **Height:** 42.5
AH: 25 **SH:** 21 **SD:** 24 **IW:** 68
Weight: 153 lbs **Cube:** 73.53

D	E	F	G	H	J	K COM	L	M	N	O	P	Q	R	S	T	U	(# above U) *	S Nail	M Nail
4725	4782	4839	4896	4953	5010	5067	5124	5181	5238	5295	5352	5409	5466	5523	5580	5637	57 (Riser) + 5637 (U)	N/A	N/A
Leather 1 N/A		Leather 2 N/A		Leather 3 N/A		Leather 4 N/A		Leather 5 N/A		Leather 6 N/A		Leather 8 N/A		COL N/A		S Nail N/A		M Nail N/A	

Fabric SKU: **NIMS-52** Leather SKU: **N/A**
 NIMBUS
Nimbus Swag Left Arm Facing Sofa

Standard Pillows: (1) 20 x 20 (1) 22 x 22 **Finish Req:** N
Standard Cushions: Blendown **Standard Finish:** Contemporary
COM: 20.5 yards **COL:** N/A

Width: 73.5 **Depth:** 44.5 **Height:** 42.5
AH: 25 **SH:** 21 **SD:** 24 **IW:** 68
Weight: 153 lbs **Cube:** 73.53

D	E	F	G	H	J	K COM	L	M	N	O	P	Q	R	S	T	U	(# above U) *	S Nail	M Nail
4725	4782	4839	4896	4953	5010	5067	5124	5181	5238	5295	5352	5409	5466	5523	5580	5637	57 (Riser) + 5637 (U)	N/A	N/A
Leather 1 N/A		Leather 2 N/A		Leather 3 N/A		Leather 4 N/A		Leather 5 N/A		Leather 6 N/A		Leather 8 N/A		COL N/A		S Nail N/A		M Nail N/A	

Fabric SKU: **NIMS-53** Leather SKU: **N/A**
 NIMBUS
Nimbus Swag Right Arm Facing Corner Sofa

Standard Pillows: (1) 20 x 20 (3) 22 x 22 **Finish Req:** N
Standard Cushions: Blendown **Standard Finish:** Contemporary
COM: 32.25 yards **COL:** N/A

Width: 117 **Depth:** 44.5 **Height:** 42.5
AH: 25 **SH:** 21 **SD:** 24 **IW:** 92
Weight: 249 lbs **Cube:** 112.18

D	E	F	G	H	J	K COM	L	M	N	O	P	Q	R	S	T	U	(# above U) *	S Nail	M Nail
6675	6765	6855	6945	7035	7125	7215	7305	7395	7485	7575	7665	7755	7845	7935	8025	8115	90 (Riser) + 8115 (U)	N/A	N/A
Leather 1 N/A		Leather 2 N/A		Leather 3 N/A		Leather 4 N/A		Leather 5 N/A		Leather 6 N/A		Leather 8 N/A		COL N/A		S Nail N/A		M Nail N/A	

Fabric SKU: **NIMS-54** Leather SKU: **N/A**
 NIMBUS
Nimbus Swag Left Arm Facing Corner Sofa

Standard Pillows: (1) 20 x 20 (3) 22 x 22 **Finish Req:** N
Standard Cushions: Blendown **Standard Finish:** Contemporary
COM: 32.25 yards **COL:** N/A

Width: 117 **Depth:** 44.5 **Height:** 42.5
AH: 25 **SH:** 21 **SD:** 24 **IW:** 92
Weight: 249 lbs **Cube:** 112.18

D	E	F	G	H	J	K COM	L	M	N	O	P	Q	R	S	T	U	(# above U) *	S Nail	M Nail
6675	6765	6855	6945	7035	7125	7215	7305	7395	7485	7575	7665	7755	7845	7935	8025	8115	90 (Riser) + 8115 (U)	N/A	N/A
Leather 1 N/A		Leather 2 N/A		Leather 3 N/A		Leather 4 N/A		Leather 5 N/A		Leather 6 N/A		Leather 8 N/A		COL N/A		S Nail N/A		M Nail N/A	

Upholstery

**Pillows are not available on leather SKUs*

Fabric SKU: **NIMS-58**

Leather SKU: **N/A**

NIMBUS

Nimbus Swag Armless Sofa

Standard Pillows: N/A **Finish Req:** N

Standard Cushions: Blendown **Standard Finish:** Contemporary

COM: 19.25 yards **COL:** N/A

Width: 68 **Depth:** 44.5 **Height:** 42.5

AH: 0 **SH:** 21 **SD:** 24 **IW:** 68

Weight: 121 lbs **Cube:** 74.42

D	E	F	G	H	J	K ^{COM}	L	M	N	O	P	Q	R	S	T	U	(# above U) *	S Nail	M Nail
4425	4479	4533	4587	4641	4695	4749	4803	4857	4911	4965	5019	5073	5127	5181	5235	5289	54 (Riser) + 5289 (U)	N/A	N/A
Leather 1 N/A		Leather 2 N/A		Leather 3 N/A		Leather 4 N/A		Leather 5 N/A		Leather 6 N/A		Leather 8 N/A		COL N/A		S Nail N/A		M Nail N/A	

Fabric SKU: **NIMS-67**

Leather SKU: **N/A**

NIMBUS

Swag Bumper Ottoman

Standard Pillows: N/A **Finish Req:** N

Standard Cushions: Blendown **Standard Finish:** Contemporary

COM: 4.75 yards **COL:** N/A

Width: 34 **Depth:** 35.5 **Height:** 22

AH: 0 **SH:** 0 **SD:** 0 **IW:** 0

Weight: 50 lbs **Cube:** 16.92

D	E	F	G	H	J	K ^{COM}	L	M	N	O	P	Q	R	S	T	U	(# above U) *	S Nail	M Nail
1275	1290	1305	1320	1335	1350	1365	1380	1395	1410	1425	1440	1455	1470	1485	1500	1515	15 (Riser) + 1515 (U)	N/A	N/A
Leather 1 N/A		Leather 2 N/A		Leather 3 N/A		Leather 4 N/A		Leather 5 N/A		Leather 6 N/A		Leather 8 N/A		COL N/A		S Nail N/A		M Nail N/A	

Fabric SKU: **NIMS-78**

Leather SKU: **N/A**

NIMBUS

Swag Armless Chair

Standard Pillows: N/A **Finish Req:** N

Standard Cushions: Blendown **Standard Finish:** Contemporary

COM: 10 yards **COL:** N/A

Width: 34.5 **Depth:** 44.5 **Height:** 42.5

AH: 0 **SH:** 21 **SD:** 24 **IW:** 0

Weight: 65 lbs **Cube:** 42.09

D	E	F	G	H	J	K ^{COM}	L	M	N	O	P	Q	R	S	T	U	(# above U) *	S Nail	M Nail
2685	2712	2739	2766	2793	2820	2847	2874	2901	2928	2955	2982	3009	3036	3063	3090	3117	27 (Riser) + 3117 (U)	N/A	N/A
Leather 1 N/A		Leather 2 N/A		Leather 3 N/A		Leather 4 N/A		Leather 5 N/A		Leather 6 N/A		Leather 8 N/A		COL N/A		S Nail N/A		M Nail N/A	

Fabric SKU: **W-S000-01**

Leather SKU: **N/A**

WASHABLE SLIPCOVERS

Cape May Lounge Chair

Slipcovered

Width: 30.5 **Depth:** 36.5 **Height:** 36.5

AH: 25.5 **SH:** 19.75 **SD:** 22 **IW:** 22.5

Weight: 93 lbs **Cube:** 23.51

Standard Pillows: N/A **Finish Req:** N

Standard Cushions: Blendown **Standard Finish:**

COM: N/A yards **COL:** N/A

Frame is upholstered in muslin and includes a slipcover. Slipcover only available in the Washable Slipcover Program Fabrics. Not available in COM or FOM.

D	E	F	G	H	J	K ^{COM}	L	M	N	O	P	Q	R	S	T	U	(# above U) *	S Nail	M Nail
N/A	N/A	N/A	N/A	N/A	2460	N/A	N/A	N/A	N/A	2550	2568	2586	N/A	N/A	N/A	2658	18 (Riser) + 2658 (U)	N/A	N/A
Leather 1 N/A		Leather 2 N/A		Leather 3 N/A		Leather 4 N/A		Leather 5 N/A		Leather 6 N/A		Leather 8 N/A		COL N/A		S Nail N/A		M Nail N/A	

Fabric SKU: **W-S000-01-C**

Leather SKU: **N/A**

WASHABLE SLIPCOVERS

Cape May Slip Cover Only

Width: 30.5 **Depth:** 36.5 **Height:** 36.5

AH: 25.5 **SH:** 19.75 **SD:** 22 **IW:** 22.5

Weight: 10 lbs **Cube:** 23.51

Standard Pillows: N/A **Finish Req:** N

Standard Cushions: N/A **Standard Finish:**

COM: N/A yards **COL:** N/A

A Slipcover only available in the Washable Slipcover Program Fabrics. Not available in COM or FOM. This slipcover pairs with W-S000-01 Chair, W-S000-31 Swivel Chair and W-S000-32 Swivel Glider.

D	E	F	G	H	J	K ^{COM}	L	M	N	O	P	Q	R	S	T	U	(# above U) *	S Nail	M Nail
N/A	N/A	N/A	N/A	N/A	600	N/A	N/A	N/A	N/A	690	708	726	N/A	N/A	N/A	798	18 (Riser) + 798 (U)	N/A	N/A
Leather 1 N/A		Leather 2 N/A		Leather 3 N/A		Leather 4 N/A		Leather 5 N/A		Leather 6 N/A		Leather 8 N/A		COL N/A		S Nail N/A		M Nail N/A	

Fabric SKU: **W-S000-31**

Leather SKU: **N/A**

WASHABLE SLIPCOVERS

Cape May Swivel Chair

Slipcovered

Width: 30.5 **Depth:** 36.5 **Height:** 36.5

AH: 25.5 **SH:** 19.75 **SD:** 22 **IW:** 22.5

Weight: 93 lbs **Cube:** 23.51

Standard Pillows: N/A **Finish Req:** N

Standard Cushions: Blendown **Standard Finish:**

COM: N/A yards **COL:** N/A

Frame is upholstered in muslin and includes a slipcover. Slipcover only available in the Washable Slipcover Program Fabrics. Not available in COM or FOM.

D	E	F	G	H	J	K ^{COM}	L	M	N	O	P	Q	R	S	T	U	(# above U) *	S Nail	M Nail
N/A	N/A	N/A	N/A	N/A	2550	N/A	N/A	N/A	N/A	2640	2658	2676	N/A	N/A	N/A	2748	18 (Riser) + 2748 (U)	N/A	N/A
Leather 1 N/A		Leather 2 N/A		Leather 3 N/A		Leather 4 N/A		Leather 5 N/A		Leather 6 N/A		Leather 8 N/A		COL N/A		S Nail N/A		M Nail N/A	

Upholstery

**Pillows are not available on leather SKUs*

Fabric SKU: **W-5000-32** Leather SKU: **N/A**
 WASHABLE SLIPCOVERS
Cape May Swivel Glider
 Slipcovered
Width: 30.5 Depth: 36.5 Height: 36.5
AH: 25.5 SH: 19.75 SD: 22 IW: 22.5
Weight: 93 lbs Cube: 23.51

Standard Pillows: N/A **Finish Req:** N
Standard Cushions: Blendown **Standard Finish:**
COM: N/A yards **COL:** N/A
 Frame is upholstered in muslin and includes a slipcover. Slipcover only available in the Washable Slipcover Program Fabrics. Not available in COM or FOM.

D N/A	E N/A	F N/A	G N/A	H N/A	J 2700	K ^{COM} N/A	L N/A	M N/A	N N/A	O 2790	P 2808	Q 2826	R N/A	S N/A	T N/A	U 2898	(# above U) * 18 (Riser) + 2898 (U)	S Nail N/A	M Nail N/A
Leather 1 N/A		Leather 2 N/A		Leather 3 N/A		Leather 4 N/A		Leather 5 N/A		Leather 6 N/A		Leather 8 N/A		COL N/A		S Nail N/A		M Nail N/A	

Fabric SKU: **W-5015-01** Leather SKU: **N/A**
 WASHABLE SLIPCOVERS
Chesapeake Lounge Chair
 Slipcovered
Width: 31 Depth: 38.5 Height: 41
AH: 23.5 SH: 19.5 SD: 21 IW: 24
Weight: 56 lbs Cube: 28.31

Standard Pillows: N/A **Finish Req:** Y
Standard Cushions: Blendown **Standard Finish:**
COM: N/A yards **COL:** N/A
 Frame is upholstered in muslin and includes a slipcover. Slipcover only available in the Washable Slipcover Program Fabrics. Not available in COM or FOM.

D N/A	E N/A	F N/A	G N/A	H N/A	J 2685	K ^{COM} N/A	L N/A	M N/A	N N/A	O 2775	P 2793	Q 2811	R N/A	S N/A	T N/A	U 2883	(# above U) * 18 (Riser) + 2883 (U)	S Nail N/A	M Nail N/A
Leather 1 N/A		Leather 2 N/A		Leather 3 N/A		Leather 4 N/A		Leather 5 N/A		Leather 6 N/A		Leather 8 N/A		COL N/A		S Nail N/A		M Nail N/A	

Fabric SKU: **W-5015-01-C** Leather SKU: **N/A**
 WASHABLE SLIPCOVERS
Chesapeake Slip Cover
Width: 31 Depth: 38.5 Height: 41
AH: 0 SH: 0 SD: 0 IW: 0
Weight: 10 lbs Cube: 28.31

Standard Pillows: N/A **Finish Req:** N
Standard Cushions: Blendown **Standard Finish:**
COM: N/A yards **COL:** N/A
 A Slipcover only available in the Washable Slipcover Program Fabrics. Not available in COM or FOM.

D N/A	E N/A	F N/A	G N/A	H N/A	J 570	K ^{COM} N/A	L N/A	M N/A	N N/A	O 660	P 678	Q 696	R N/A	S N/A	T N/A	U 768	(# above U) * 18 (Riser) + 768 (U)	S Nail N/A	M Nail N/A
Leather 1 N/A		Leather 2 N/A		Leather 3 N/A		Leather 4 N/A		Leather 5 N/A		Leather 6 N/A		Leather 8 N/A		COL N/A		S Nail N/A		M Nail N/A	

Fabric SKU: **W-5015-50** Leather SKU: **N/A**
 WASHABLE SLIPCOVERS
Chesapeake Sofa Three backs over one seat
 Slipcovered
Width: 89 Depth: 38.5 Height: 41
AH: 23.5 SH: 19.5 SD: 21 IW: 82
Weight: 100 lbs Cube: 81.3

Standard Pillows: N/A **Finish Req:** Y
Standard Cushions: Blendown **Standard Finish:**
COM: N/A yards **COL:** N/A
 Frame is upholstered in muslin and includes a slipcover. Slipcover only available in the Washable Slipcover Program Fabrics. Not available in COM or FOM.

D N/A	E N/A	F N/A	G N/A	H N/A	J 4500	K ^{COM} N/A	L N/A	M N/A	N N/A	O 4695	P 4734	Q 4773	R N/A	S N/A	T N/A	U 4929	(# above U) * 39 (Riser) + 4929 (U)	S Nail N/A	M Nail N/A
Leather 1 N/A		Leather 2 N/A		Leather 3 N/A		Leather 4 N/A		Leather 5 N/A		Leather 6 N/A		Leather 8 N/A		COL N/A		S Nail N/A		M Nail N/A	

Fabric SKU: **W-5015-50-C** Leather SKU: **N/A**
 WASHABLE SLIPCOVERS
Chesapeake Slip Cover only-Three backs over one seat
Width: 89 Depth: 38.5 Height: 41
AH: 0 SH: 0 SD: 0 IW: 0
Weight: 10 lbs Cube: 81.3

Standard Pillows: N/A **Finish Req:** N
Standard Cushions: Blendown **Standard Finish:**
COM: N/A yards **COL:** N/A
 A Slipcover only available in the Washable Slipcover Program Fabrics. Not available in COM or FOM.

D N/A	E N/A	F N/A	G N/A	H N/A	J 1050	K ^{COM} N/A	L N/A	M N/A	N N/A	O 1245	P 1284	Q 1323	R N/A	S N/A	T N/A	U 1479	(# above U) * 39 (Riser) + 1479 (U)	S Nail N/A	M Nail N/A
Leather 1 N/A		Leather 2 N/A		Leather 3 N/A		Leather 4 N/A		Leather 5 N/A		Leather 6 N/A		Leather 8 N/A		COL N/A		S Nail N/A		M Nail N/A	

Fabric SKU: **W-5025-50** Leather SKU: **N/A**
 WASHABLE SLIPCOVERS
Chesapeake Sofa Two backs over two seats
 Slipcovered
Width: 89 Depth: 38.5 Height: 41
AH: 23.5 SH: 19.5 SD: 21 IW: 82
Weight: 105 lbs Cube: 81.3

Standard Pillows: N/A **Finish Req:** Y
Standard Cushions: Blendown **Standard Finish:**
COM: N/A yards **COL:** N/A
 Frame is upholstered in muslin and includes a slipcover. Slipcover only available in the Washable Slipcover Program Fabrics. Not available in COM or FOM.

D N/A	E N/A	F N/A	G N/A	H N/A	J 4500	K ^{COM} N/A	L N/A	M N/A	N N/A	O 4695	P 4734	Q 4773	R N/A	S N/A	T N/A	U 4929	(# above U) * 39 (Riser) + 4929 (U)	S Nail N/A	M Nail N/A
Leather 1 N/A		Leather 2 N/A		Leather 3 N/A		Leather 4 N/A		Leather 5 N/A		Leather 6 N/A		Leather 8 N/A		COL N/A		S Nail N/A		M Nail N/A	

Upholstery

**Pillows are not available on leather SKUs*

Fabric SKU: **W-S025-50-C** Leather SKU: **N/A**
 WASHABLE SLIPCOVERS
Chesapeake Slip Cover only-Two backs over two seats

Width: 89 **Depth:** 38.5 **Height:** 41
AH: 23.5 **SH:** 19.5 **SD:** 21 **IW:** 82
Weight: 10 lbs **Cube:** 81.3

Standard Pillows: N/A **Finish Req:** N
Standard Cushions: N/A **Standard Finish:**
COM: N/A yards **COL:** N/A
 A Slipcover only available in the Washable Slipcover Program Fabrics. Not available in COM or FOM.

D	E	F	G	H	J	K ^{COM}	L	M	N	O	P	Q	R	S	T	U	(# above U) *	S Nail	M Nail
N/A	N/A	N/A	N/A	N/A	1050	N/A	N/A	N/A	N/A	1245	1284	1323	N/A	N/A	N/A	1479	39 (Riser) + 1479 (U)	N/A	N/A
Leather 1 N/A		Leather 2 N/A		Leather 3 N/A		Leather 4 N/A		Leather 5 N/A		Leather 6 N/A		Leather 8 N/A		COL N/A		S Nail N/A		M Nail N/A	

Fabric SKU: **W-S101-01** Leather SKU: **N/A**
 WASHABLE SLIPCOVERS
Baldwin Slipcovered Lounge Chair

Width: 33.5 **Depth:** 39.5 **Height:** 41.5
AH: 24.5 **SH:** 20 **SD:** 22 **IW:** 26.5
Weight: 75 lbs **Cube:** 31.77

Standard Pillows: N/A **Finish Req:** N
Standard Cushions: Blendown **Standard Finish:** Traditional
COM: N/A yards **COL:** N/A
 Frame is upholstered in muslin and includes a slipcover. Slipcover only available in the Washable Slipcover Program Fabrics. Not available in COM or FOM.

D	E	F	G	H	J	K ^{COM}	L	M	N	O	P	Q	R	S	T	U	(# above U) *	S Nail	M Nail
N/A	N/A	N/A	N/A	N/A	2670	N/A	N/A	N/A	N/A	2820	2850	2880	N/A	N/A	N/A	3000	30 (Riser) + 3000 (U)	N/A	N/A
Leather 1 N/A		Leather 2 N/A		Leather 3 N/A		Leather 4 N/A		Leather 5 N/A		Leather 6 N/A		Leather 8 N/A		COL N/A		S Nail N/A		M Nail N/A	

Fabric SKU: **W-S101-01-C** Leather SKU: **N/A**
 WASHABLE SLIPCOVERS
Baldwin Slipcover Only

Width: 33.5 **Depth:** 39.5 **Height:** 41.5
AH: 24.5 **SH:** 20 **SD:** 22 **IW:** 26.5
Weight: 5 lbs **Cube:** 31.77

Standard Pillows: N/A **Finish Req:** N
Standard Cushions: N/A **Standard Finish:**
COM: N/A yards **COL:** N/A
 A Slipcover only available in the Washable Slipcover Program Fabrics. Not available in COM or FOM. This slipcover pairs with W-S101-01 Chair, W-S101-31 Swivel Chair and W-S101-32 Swivel Glider.

D	E	F	G	H	J	K ^{COM}	L	M	N	O	P	Q	R	S	T	U	(# above U) *	S Nail	M Nail
N/A	N/A	N/A	N/A	N/A	585	N/A	N/A	N/A	N/A	735	765	795	N/A	N/A	N/A	915	30 (Riser) + 915 (U)	N/A	N/A
Leather 1 N/A		Leather 2 N/A		Leather 3 N/A		Leather 4 N/A		Leather 5 N/A		Leather 6 N/A		Leather 8 N/A		COL N/A		S Nail N/A		M Nail N/A	

Fabric SKU: **W-S101-31** Leather SKU: **N/A**
 WASHABLE SLIPCOVERS
Baldwin Slipcovered Swivel Chair

Width: 33.5 **Depth:** 39.5 **Height:** 41.5
AH: 24.5 **SH:** 20 **SD:** 22 **IW:** 26.5
Weight: 75 lbs **Cube:** 31.77

Standard Pillows: N/A **Finish Req:** N
Standard Cushions: Blendown **Standard Finish:** Traditional
COM: N/A yards **COL:** N/A
 Frame is upholstered in muslin and includes a slipcover. Slipcover only available in the Washable Slipcover Program Fabrics. Not available in COM or FOM.

D	E	F	G	H	J	K ^{COM}	L	M	N	O	P	Q	R	S	T	U	(# above U) *	S Nail	M Nail
N/A	N/A	N/A	N/A	N/A	2745	N/A	N/A	N/A	N/A	2895	2925	2955	N/A	N/A	N/A	3075	30 (Riser) + 3075 (U)	N/A	N/A
Leather 1 N/A		Leather 2 N/A		Leather 3 N/A		Leather 4 N/A		Leather 5 N/A		Leather 6 N/A		Leather 8 N/A		COL N/A		S Nail N/A		M Nail N/A	

Fabric SKU: **W-S101-75** Leather SKU: **N/A**
 WASHABLE SLIPCOVERS
Baldwin Slipcovered Sofa

Width: 75 **Depth:** 39.5 **Height:** 41.5
AH: 24.5 **SH:** 20 **SD:** 22 **IW:** 68
Weight: 130 lbs **Cube:** 71.14

Standard Pillows: N/A **Finish Req:** N
Standard Cushions: Blendown **Standard Finish:** Traditional
COM: N/A yards **COL:** N/A
 Frame is upholstered in muslin and includes a slipcover. Slipcover only available in the Washable Slipcover Program Fabrics. Not available in COM or FOM.

D	E	F	G	H	J	K ^{COM}	L	M	N	O	P	Q	R	S	T	U	(# above U) *	S Nail	M Nail
N/A	N/A	N/A	N/A	N/A	4200	N/A	N/A	N/A	N/A	4500	4560	4620	N/A	N/A	N/A	4860	60 (Riser) + 4860 (U)	N/A	N/A
Leather 1 N/A		Leather 2 N/A		Leather 3 N/A		Leather 4 N/A		Leather 5 N/A		Leather 6 N/A		Leather 8 N/A		COL N/A		S Nail N/A		M Nail N/A	

Fabric SKU: **W-S101-75-C** Leather SKU: **N/A**
 WASHABLE SLIPCOVERS
Baldwin Slipcover Only

Width: 75 **Depth:** 39.5 **Height:** 41.5
AH: 24.5 **SH:** 20 **SD:** 22 **IW:** 68
Weight: 5 lbs **Cube:** 71.14

Standard Pillows: N/A **Finish Req:** N
Standard Cushions: N/A **Standard Finish:**
COM: N/A yards **COL:** N/A
 A Slipcover only available in the Washable Slipcover Program Fabrics. Not available in COM or FOM.

D	E	F	G	H	J	K ^{COM}	L	M	N	O	P	Q	R	S	T	U	(# above U) *	S Nail	M Nail
N/A	N/A	N/A	N/A	N/A	1050	N/A	N/A	N/A	N/A	1350	1410	1470	N/A	N/A	N/A	1710	60 (Riser) + 1710 (U)	N/A	N/A
Leather 1 N/A		Leather 2 N/A		Leather 3 N/A		Leather 4 N/A		Leather 5 N/A		Leather 6 N/A		Leather 8 N/A		COL N/A		S Nail N/A		M Nail N/A	

Upholstery

**Pillows are not available on leather SKUs*

Fabric SKU: **W-S101-85** Leather SKU: **N/A**
 WASHABLE SLIPCOVERS
Baldwin Slipcovered Sofa

Width: 85 **Depth:** 39.5 **Height:** 41.5
AH: 24.5 **SH:** 20 **SD:** 22 **IW:** 78
Weight: 130 lbs **Cube:** 80.63

Standard Pillows: N/A **Finish Req:** N
Standard Cushions: Blendown **Standard Finish:** Traditional
COM: N/A yards **COL:** N/A
 Frame is upholstered in muslin and includes a slipcover. Slipcover only available in the Washable Slipcover Program Fabrics. Not available in COM or FOM.

D	E	F	G	H	J	K ^{COM}	L	M	N	O	P	Q	R	S	T	U	(# above U) *	S Nail	M Nail
N/A	N/A	N/A	N/A	N/A	4500	N/A	N/A	N/A	N/A	4800	4860	4920	N/A	N/A	N/A	5160	60 (Riser) + 5160 (U)	N/A	N/A
Leather 1		Leather 2		Leather 3		Leather 4		Leather 5		Leather 6		Leather 8		COL		S Nail		M Nail	
N/A		N/A		N/A		N/A		N/A		N/A		N/A		N/A		N/A		N/A	

Fabric SKU: **W-S101-85-C** Leather SKU: **N/A**
 WASHABLE SLIPCOVERS
Baldwin Slipcover Only

Width: 85 **Depth:** 39.5 **Height:** 41.5
AH: 24.5 **SH:** 20 **SD:** 22 **IW:** 78
Weight: 5 lbs **Cube:** 80.63

Standard Pillows: N/A **Finish Req:** N
Standard Cushions: N/A **Standard Finish:**
COM: N/A yards **COL:** N/A
 A Slipcover only available in the Washable Slipcover Program Fabrics. Not available in COM or FOM.

D	E	F	G	H	J	K ^{COM}	L	M	N	O	P	Q	R	S	T	U	(# above U) *	S Nail	M Nail
N/A	N/A	N/A	N/A	N/A	1200	N/A	N/A	N/A	N/A	1500	1560	1620	N/A	N/A	N/A	1860	60 (Riser) + 1860 (U)	N/A	N/A
Leather 1		Leather 2		Leather 3		Leather 4		Leather 5		Leather 6		Leather 8		COL		S Nail		M Nail	
N/A		N/A		N/A		N/A		N/A		N/A		N/A		N/A		N/A		N/A	

Fabric SKU: **W-S101-95** Leather SKU: **N/A**
 WASHABLE SLIPCOVERS
Baldwin Slipcovered Sofa

Width: 95 **Depth:** 39.5 **Height:** 41.5
AH: 24.5 **SH:** 20 **SD:** 22 **IW:** 88
Weight: 130 lbs **Cube:** 102.13

Standard Pillows: N/A **Finish Req:** N
Standard Cushions: Blendown **Standard Finish:** Traditional
COM: N/A yards **COL:** N/A
 Frame is upholstered in muslin and includes a slipcover. Slipcover only available in the Washable Slipcover Program Fabrics. Not available in COM or FOM.

D	E	F	G	H	J	K ^{COM}	L	M	N	O	P	Q	R	S	T	U	(# above U) *	S Nail	M Nail
N/A	N/A	N/A	N/A	N/A	4800	N/A	N/A	N/A	N/A	5100	5160	5220	N/A	N/A	N/A	5460	60 (Riser) + 5460 (U)	N/A	N/A
Leather 1		Leather 2		Leather 3		Leather 4		Leather 5		Leather 6		Leather 8		COL		S Nail		M Nail	
N/A		N/A		N/A		N/A		N/A		N/A		N/A		N/A		N/A		N/A	

Fabric SKU: **W-S101-95-C** Leather SKU: **N/A**
 WASHABLE SLIPCOVERS
Baldwin Slipcover Only

Width: 95 **Depth:** 39.5 **Height:** 41.5
AH: 24.5 **SH:** 20 **SD:** 22 **IW:** 88
Weight: 5 lbs **Cube:** 90.12

Standard Pillows: N/A **Finish Req:** N
Standard Cushions: N/A **Standard Finish:**
COM: N/A yards **COL:** N/A
 A Slipcover only available in the Washable Slipcover Program Fabrics. Not available in COM or FOM.

D	E	F	G	H	J	K ^{COM}	L	M	N	O	P	Q	R	S	T	U	(# above U) *	S Nail	M Nail
N/A	N/A	N/A	N/A	N/A	1350	N/A	N/A	N/A	N/A	1650	1710	1770	N/A	N/A	N/A	2010	60 (Riser) + 2010 (U)	N/A	N/A
Leather 1		Leather 2		Leather 3		Leather 4		Leather 5		Leather 6		Leather 8		COL		S Nail		M Nail	
N/A		N/A		N/A		N/A		N/A		N/A		N/A		N/A		N/A		N/A	

Fabric SKU: **W-S252-05** Leather SKU: **N/A**
 WASHABLE SLIPCOVERS
Melrose Slipcovered Tall Side Chair

Width: 19.5 **Depth:** 27 **Height:** 41
AH: 0 **SH:** 20 **SD:** 19 **IW:** 19.5
Weight: 25 lbs **Cube:** 12.49

Standard Pillows: N/A **Finish Req:** N
Standard Cushions: High Resiliency 40 **Standard Finish:** Tobacco
COM: N/A yards **COL:** N/A
 Frame is upholstered in muslin and includes a slipcover. Slipcover only available in the Washable Slipcover Program Fabrics. Not available in COM or FOM.

D	E	F	G	H	J	K ^{COM}	L	M	N	O	P	Q	R	S	T	U	(# above U) *	S Nail	M Nail
N/A	N/A	N/A	N/A	N/A	675	N/A	N/A	N/A	N/A	720	729	738	N/A	N/A	N/A	774	9 (Riser) + 774 (U)	N/A	N/A
Leather 1		Leather 2		Leather 3		Leather 4		Leather 5		Leather 6		Leather 8		COL		S Nail		M Nail	
N/A		N/A		N/A		N/A		N/A		N/A		N/A		N/A		N/A		N/A	

Fabric SKU: **W-S252-05-C** Leather SKU: **N/A**
 WASHABLE SLIPCOVERS
Melrose Slipcover Only

Width: 19.5 **Depth:** 27 **Height:** 41
AH: 0 **SH:** 20 **SD:** 19 **IW:** 19.5
Weight: 20 lbs **Cube:** 12.49

Standard Pillows: N/A **Finish Req:** N
Standard Cushions: N/A **Standard Finish:**
COM: N/A yards **COL:** N/A
 A Slipcover only available in the Washable Slipcover Program Fabrics. Not available in COM or FOM.

D	E	F	G	H	J	K ^{COM}	L	M	N	O	P	Q	R	S	T	U	(# above U) *	S Nail	M Nail
N/A	N/A	N/A	N/A	N/A	195	N/A	N/A	N/A	N/A	240	249	258	N/A	N/A	N/A	294	9 (Riser) + 294 (U)	N/A	N/A
Leather 1		Leather 2		Leather 3		Leather 4		Leather 5		Leather 6		Leather 8		COL		S Nail		M Nail	
N/A		N/A		N/A		N/A		N/A		N/A		N/A		N/A		N/A		N/A	

Casegoods

4037-95 — Price: \$747

End Table

Collection: CALLAHAN

Dimensions: 20w × 26d × 25h Weight: 25 / 25 lbs Cube: 7.52

Standard Finish: Louve Apron Height: N/A

Materials: High Pressure Laminate, Red Oak Solids and Veneers

Highlight Striping: N/A

Contrasting Finishes or Paints: N/A

Conversion Varnish: N/A

Paint Match: N/A

Commercial grade laminate and solid wood in Louve Finish

Country: CHINA Assembly Req: N

4037-CK — Price: \$1197

Cocktail Table

Collection: CALLAHAN

Dimensions: 48w × 26d × 18h Weight: 48 / 48 lbs Cube: 13

Standard Finish: Louve Apron Height: N/A

Materials: High Pressure Laminate, Red Oak Solids and Veneers

Highlight Striping: N/A

Contrasting Finishes or Paints: N/A

Conversion Varnish: N/A

Paint Match: N/A

Commercial grade laminate and solid wood in Louve Finish

Country: CHINA Assembly Req: N

4037-CS — Price: \$807

End Table

Collection: CALLAHAN

Dimensions: 26w × 26d × 25h Weight: 30 / 30 lbs Cube: 9.78

Standard Finish: Louve Apron Height: N/A

Materials: High Pressure Laminate, Red Oak Solids and Veneers

Highlight Striping: N/A

Contrasting Finishes or Paints: N/A

Conversion Varnish: N/A

Paint Match: N/A

Commercial grade laminate and solid wood in Louve Finish

Country: CHINA Assembly Req: N

4037-HT — Price: \$1287

Console Table

Collection: CALLAHAN

Dimensions: 56w × 13.5d × 34h Weight: 50 / 50 lbs Cube: 14.87

Standard Finish: Louve Apron Height: N/A

Materials: High Pressure Laminate, Red Oak Solids and Veneers

Highlight Striping: N/A

Contrasting Finishes or Paints: N/A

Conversion Varnish: N/A

Paint Match: N/A

Commercial grade laminate and solid wood in Louve Finish

Country: CHINA Assembly Req: N

4159-19 — Price: \$837

La Jolla Round End Table

Collection: LA JOLLA, LAMINATE

Dimensions: 24w × 24d × 25h Weight: 39 / 39 lbs Cube: 11.92

Standard Finish: Scrubbed Oak Apron Height: N/A

Materials: High Pressured Laminate with solid wood

Highlight Striping: N/A

Contrasting Finishes or Paints: N/A

Conversion Varnish: N/A

Paint Match: N/A

Laminate finished in Scrubbed Oak with Antique Brass stretchers and ferrules.

Country: CHINA Assembly Req: Y

4159-91 — Price: \$1317

La Jolla Round Cocktail Table

Collection: LA JOLLA

Dimensions: 36w × 36d × 18.25h Weight: 62 / 62 lbs Cube: 9.8

Standard Finish: Scrubbed Oak Apron Height: N/A

Materials: High Pressured Laminate with solid wood

Highlight Striping: N/A

Contrasting Finishes or Paints: N/A

Conversion Varnish: N/A

Paint Match: N/A

Laminate finished in Scrubbed Oak with four open shelves and Antique Brass ferrules.

Country: CHINA Assembly Req: Y

4160-88 — Price: \$717

La Jolla Drink Table

Collection: LA JOLLA

Dimensions: 16w × 16d × 24.5h Weight: 19 / 19 lbs Cube: 2.4

Standard Finish: Fumed Oak Apron Height: N/A

Materials: High Pressured Laminate with solid wood

Highlight Striping: N/A

Contrasting Finishes or Paints: N/A

Conversion Varnish: N/A

Paint Match: N/A

Laminate finished in Fumed Oak with four open shelves and Antique Brass ferrules.

Country: CHINA Assembly Req: N

4160-91 — Price: \$1317

La Jolla Round Cocktail Table

Collection: LA JOLLA

Dimensions: 36w × 36d × 18.25h Weight: 62 / 62 lbs Cube: 9.8

Standard Finish: Fumed Oak Apron Height: N/A

Materials: High Pressured Laminate with solid wood

Highlight Striping: N/A

Contrasting Finishes or Paints: N/A

Conversion Varnish: N/A

Paint Match: N/A

Laminate finished in Fumed Oak with four open shelves and Antique Brass ferrules.

Country: CHINA Assembly Req: Y

Casegoods

4161-93 — Price: \$1977

Zuma Cocktail Table

Collection: ZUMA

Dimensions: 46w × 24d × 18.5h Weight: 49 / 49 lbs Cube: 8.2

Standard Finish: Fumed Oak Apron Height: N/A

Materials: High Pressured Laminate with solid wood

Highlight Striping: N/A

Contrasting Finishes or Paints: N/A

Conversion Varnish: N/A

Paint Match: N/A

Commercial grade laminate finished in Fumed Oak with a Carrara marble top and one bottom shelf.

Country: CHINA Assembly Req: Y

4163-19 — Price: \$837

Avignon Round End Table

Collection: AVIGNON, LAMINATE

Dimensions: 24w × 24d × 24h Weight: 26 / 26 lbs Cube: 3.24

Standard Finish: Anjou Apron Height: 20.5

Materials: Beech Solids & Laminate

Highlight Striping: N/A

Contrasting Finishes or Paints: N/A

Conversion Varnish: N/A

Paint Match: N/A

Commercial grade laminate and solid wood in Anjou finish.

Country: CHINA Assembly Req: Y

4163-86 — Price: \$1257

Avignon Activity Table

Collection: AVIGNON, LAMINATE OCCASIONAL

Dimensions: 36w × 36d × 30h Weight: 54 / 54 lbs Cube: 5.79

Standard Finish: Anjou Apron Height: 25.75

Materials: Beech Solids & Laminate

Highlight Striping: N/A

Contrasting Finishes or Paints: N/A

Conversion Varnish: N/A

Paint Match: N/A

Commercial grade laminate and solid wood in Anjou finish.

Country: CHINA Assembly Req: Y

4163-88 — Price: \$657

Avignon Drink Table

Collection: AVIGNON, LAMINATE OCCASIONAL

Dimensions: 16w × 16d × 23.5h Weight: 16 / 16 lbs Cube: 2.21

Standard Finish: Anjou Apron Height: 20.25

Materials: Beech Solids & Laminate

Highlight Striping: N/A

Contrasting Finishes or Paints: N/A

Conversion Varnish: N/A

Paint Match: N/A

Commercial grade laminate and solid wood in Anjou finish.

Country: CHINA Assembly Req: Y

4163-93 — Price: \$1077

Avignon Rectangular Cocktail Table

Collection: AVIGNON, LAMINATE

Dimensions: 48w × 24d × 18h Weight: 53 / 53 lbs Cube: 6.58

Standard Finish: Anjou Apron Height: 14

Materials: Beech Solids & Laminate

Highlight Striping: N/A

Contrasting Finishes or Paints: N/A

Conversion Varnish: N/A

Paint Match: N/A

Commercial grade laminate and solid wood in Anjou finish.

Country: CHINA Assembly Req: Y

4163-99 — Price: \$1137

Avignon Console Table

Collection: AVIGNON, LAMINATE OCCASIONAL

Dimensions: 60w × 18d × 30h Weight: 54 / 54 lbs Cube: 6.27

Standard Finish: Anjou Apron Height: 26

Materials: Beech Solids & Laminate

Highlight Striping: N/A

Contrasting Finishes or Paints: N/A

Conversion Varnish: N/A

Paint Match: N/A

Commercial grade laminate and solid wood in Anjou finish.

Country: CHINA Assembly Req: Y

4164-19 — Price: \$837

Avignon Round End Table

Collection: AVIGNON, LAMINATE

Dimensions: 24w × 24d × 24h Weight: 26 / 26 lbs Cube: 3.24

Standard Finish: Louve Apron Height: 20.5

Materials: Beech Solids & Laminate

Highlight Striping: N/A

Contrasting Finishes or Paints: N/A

Conversion Varnish: N/A

Paint Match: N/A

Commercial grade laminate and solid wood in Louve finish.

Country: CHINA Assembly Req: Y

4164-86 — Price: \$1197

Avignon Activity Table

Collection: AVIGNON, LAMINATE

Dimensions: 36w × 36d × 30h Weight: 54 / 54 lbs Cube: 5.79

Standard Finish: Louve Apron Height: 25.75

Materials: Beech Solids & Laminate

Highlight Striping: N/A

Contrasting Finishes or Paints: N/A

Conversion Varnish: N/A

Paint Match: N/A

Commercial grade laminate and solid wood in Louve finish.

Country: CHINA Assembly Req: Y

Casegoods

4164-88 — Price: \$657

Avignon Drink Table

Collection: AVIGNON, LAMINATE

Dimensions: 16w × 16d × 23.5h Weight: 16 / 16 lbs Cube: 2.21

Standard Finish: Louve Apron Height: 20.25

Materials: Beech Solids & Laminate

Highlight Striping: N/A

Contrasting Finishes or Paints: N/A

Conversion Varnish: N/A

Paint Match: N/A

Commercial grade laminate and solid wood in Louve finish.

Country: CHINA Assembly Req: Y

4164-93 — Price: \$1077

Avignon Rectangular Cocktail Table

Collection: AVIGNON, LAMINATE

Dimensions: 48w × 24d × 18h Weight: 53 / 53 lbs Cube: 6.58

Standard Finish: Louve Apron Height: 14

Materials: Beech Solids & Laminate

Highlight Striping: N/A

Contrasting Finishes or Paints: N/A

Conversion Varnish: N/A

Paint Match: N/A

Commercial grade laminate and solid wood in Louve finish.

Country: CHINA Assembly Req: Y

4164-94 — Price: \$867

Avignon Square End Table

Collection: AVIGNON, LAMINATE

Dimensions: 24w × 24d × 24.5h Weight: 34 / 34 lbs Cube: 3.56

Standard Finish: Louve Apron Height: 20.5

Materials: Beech Solids & Laminate

Highlight Striping: N/A

Contrasting Finishes or Paints: N/A

Conversion Varnish: N/A

Paint Match: N/A

Commercial grade laminate and solid wood in Louve finish.

Country: CHINA Assembly Req: Y

4164-99 — Price: \$1137

Avignon Console Table

Collection: AVIGNON, LAMINATE

Dimensions: 60w × 18d × 30h Weight: 54 / 54 lbs Cube: 6.27

Standard Finish: Louve Apron Height: 26

Materials: Beech Solids & Laminate

Highlight Striping: N/A

Contrasting Finishes or Paints: N/A

Conversion Varnish: N/A

Paint Match: N/A

Commercial grade laminate and solid wood in Louve finish.

Country: CHINA Assembly Req: Y

4171-86 — Price: \$1407

Crescent Activity and Dining Table

Collection: CRESCENT, LAMINATE

Dimensions: 42w × 42d × 30h Weight: 67 / 67 lbs Cube: 7.61

Standard Finish: Graystone Apron Height: N/A

Materials: High Pressured Laminate with solid wood

Highlight Striping: N/A

Contrasting Finishes or Paints: N/A

Conversion Varnish: N/A

Paint Match: N/A

Commercial grade laminate top and solid wood edges finished in Graystone with Nickel ferrules.

Country: CHINA Assembly Req: Y

4171-AT — Price: \$927

Crescent Round Accent Table

Collection: CRESCENT

Dimensions: 24w × 24d × 24.5h Weight: 22 / 22 lbs Cube: 2.53

Standard Finish: Graystone Apron Height: N/A

Materials: High Pressured Laminate with solid wood

Highlight Striping: N/A

Contrasting Finishes or Paints: N/A

Conversion Varnish: N/A

Paint Match: N/A

Commercial grade laminate in Graystone finish and Nickel ferrules.

Country: CHINA Assembly Req: Y

4173-28 — Price: \$807

McDonald Round Accent Table

Collection: LAMINATE, MCDONALD

Dimensions: 23w × 23d × 24.5h Weight: 25 / 25 lbs Cube: 2.49

Standard Finish: Walnut Apron Height: N/A

Materials: High Pressured Laminate with solid wood

Highlight Striping: N/A

Contrasting Finishes or Paints: N/A

Conversion Varnish: N/A

Paint Match: N/A

Commercial grade laminate in Walnut finish with one fixed shelf.

Country: CHINA Assembly Req: Y

4173-94 — Price: \$807

McDonald Square End Table

Collection: LAMINATE, MCDONALD

Dimensions: 26w × 26d × 24.5h Weight: 25 / 25 lbs Cube: 2.79

Standard Finish: Walnut Apron Height: N/A

Materials: High Pressured Laminate with solid wood

Highlight Striping: N/A

Contrasting Finishes or Paints: N/A

Conversion Varnish: N/A

Paint Match: N/A

Commercial grade laminate in Walnut finish. Features one fixed shelf.

Country: CHINA Assembly Req: Y

Casegoods

4173-95 — Price: \$807

McDonald Rectangular End Table

Collection: MCDONALD

Dimensions: 22w × 26d × 24.5h Weight: 20 / 20 lbs Cube: 2.49

Standard Finish: Walnut Apron Height: N/A

Materials: High Pressured Laminate with solid wood

Highlight Striping: N/A

Contrasting Finishes or Paints: N/A

Conversion Varnish: N/A

Paint Match: N/A

Commercial grade laminate in Walnut finish.

Country: CHINA Assembly Req: Y

4173-99 — Price: \$867

McDonald Sofa Table

Collection: MCDONALD

Dimensions: 48w × 16d × 28.5h Weight: 30 / 30 lbs Cube: 3.26

Standard Finish: Walnut Apron Height: N/A

Materials: High Pressured Laminate with solid wood

Highlight Striping: N/A

Contrasting Finishes or Paints: N/A

Conversion Varnish: N/A

Paint Match: N/A

Commercial grade laminate in Walnut finish.

Country: CHINA Assembly Req: Y

4176-AT — Price: \$807

Laminate Round Accent Table

Collection: LAMINATE OCCASIONAL

Dimensions: 23w × 23d × 24.5h Weight: 20 / 20 lbs Cube: 2.63

Standard Finish: Light Cherry Apron Height: N/A

Materials: High Pressured Laminate with solid wood

Highlight Striping: N/A

Contrasting Finishes or Paints: N/A

Conversion Varnish: N/A

Paint Match: N/A

Commercial grade laminate in Light Cherry finish.

Country: CHINA Assembly Req: Y

4177-28 — Price: \$927

Campaigna Round Accent Table

Collection: CAMPAIGNA, LAMINATE

Dimensions: 23w × 23d × 24.5h Weight: 20 / 20 lbs Cube: 2.7

Standard Finish: Cafe Mocha Apron Height: N/A

Materials: High Pressured Laminate with solid wood

Highlight Striping: N/A

Contrasting Finishes or Paints: N/A

Conversion Varnish: N/A

Paint Match: N/A

Commercial grade laminate in Café Mocha finish. Features one fixed shelf.

Country: CHINA Assembly Req: Y

4177-46 — Price: \$1047

Campaigna Oval Cocktail Table

Collection: CAMPAIGNA, LAMINATE

Dimensions: 42w × 24d × 18.5h Weight: 40 / 40 lbs Cube: 4.57

Standard Finish: Cafe Mocha Apron Height: N/A

Materials: High Pressured Laminate with solid wood

Highlight Striping: N/A

Contrasting Finishes or Paints: N/A

Conversion Varnish: N/A

Paint Match: N/A

Commercial grade laminate in Café Mocha finish. Features one fixed shelf.

Country: CHINA Assembly Req: Y

4177-86 — Price: \$1437

Campaigna Activity and Dining Table

Collection: CAMPAIGNA, LAMINATE

Dimensions: 42w × 42d × 30h Weight: 50 / 50 lbs Cube: 7.36

Standard Finish: Cafe Mocha Apron Height: N/A

Materials: High Pressured Laminate with solid wood

Highlight Striping: N/A

Contrasting Finishes or Paints: N/A

Conversion Varnish: N/A

Paint Match: N/A

High Pressured Laminate with solid wood.

Country: CHINA Assembly Req: Y

4177-95 — Price: \$867

Campaigna Rectangular End Table

Collection: CAMPAIGNA, LAMINATE

Dimensions: 22w × 26d × 24.5h Weight: 25 / 25 lbs Cube: 3.05

Standard Finish: Cafe Mocha Apron Height: N/A

Materials: High Pressured Laminate with solid wood

Highlight Striping: N/A

Contrasting Finishes or Paints: N/A

Conversion Varnish: N/A

Paint Match: N/A

Commercial grade laminate in Café Mocha finish. Features one fixed shelf.

Country: CHINA Assembly Req: Y

4179-86 — Price: \$1437

Crescent Activity and Dining Table

Collection: CRESCENT, LAMINATE

Dimensions: 42w × 42d × 30h Weight: 67 / 67 lbs Cube: 7.61

Standard Finish: Suede Apron Height: N/A

Materials: High Pressured Laminate with solid wood

Highlight Striping: N/A

Contrasting Finishes or Paints: N/A

Conversion Varnish: N/A

Paint Match: N/A

Commercial grade laminate in Suede finish with Nickel ferrules.

Country: CHINA Assembly Req: Y

Casegoods

4200-DT-E — Price: \$3597

Essa Trestle Dining Table

Collection: BD COLLECTION FOR FAIRFIELD

Dimensions: 92w × 42d × 30h Weight: 243 / 243 lbs Cube: 67.08

Standard Finish: English Honey Apron Height: N/A

Materials: Ash Solids and Veneers

Highlight Striping: N/A

Contrasting Finishes or Paints: N/A

Conversion Varnish: +\$540

Paint Match: +\$899

Also available in any Monogram Finish as M200-DT

Country: CHINA Assembly Req: Y

Also Available:

M200-DT in Custom Finishes at \$5247

4201-DT-A — Price: \$3897

Cooper Dining Table

Collection: BD COLLECTION FOR FAIRFIELD

Dimensions: 90w × 42d × 30h Weight: 293 / 293 lbs Cube: 28.46

Standard Finish: Antique Pinewood Apron Height: 27

Materials: Ash Solids and Veneers

Highlight Striping: N/A

Contrasting Finishes or Paints: N/A

Conversion Varnish: +\$585

Paint Match: +\$974

Finished in Antique Pinewood. Features two 18" Leaves. Width with one 18" leaf is 108" and with two 18" leaves is 126". Full Extended Dimensions: 126" x 42" x 31". Also available in any Monogram finish as M201-DT

Country: CHINA Assembly Req: Y

Also Available:

M201-DT in Custom Finishes at \$5397

4201-DT-E — Price: \$3897

Cooper Dining Table

Collection: BD COLLECTION FOR FAIRFIELD

Dimensions: 90w × 42d × 30h Weight: 293 / 293 lbs Cube: 28.46

Standard Finish: English Honey Apron Height: 27

Materials: Ash Solids and Veneers

Highlight Striping: N/A

Contrasting Finishes or Paints: N/A

Conversion Varnish: +\$585

Paint Match: +\$974

Finished in English Honey. Features two 18" Leaves. Width with one 18" leaf is 108" and with two 18" leaves is 126" Full Extended Dimensions: 126" x 42" x 31". Also available in any Monogram Finish as M201-DT

Country: CHINA Assembly Req: Y

Also Available:

M201-DT in Custom Finishes at \$5397

4305-18 — Price: \$6747

Pamela Curio Cabinet

Collection: BD COLLECTION FOR FAIRFIELD

Dimensions: 60w × 20d × 84h Weight: 317 / 317 lbs Cube: 65.36

Standard Finish: Antique Pinewood Apron Height: N/A

Materials: Ash Solids and Veneers

Highlight Striping: N/A

Contrasting Finishes or Paints: +\$1687

Conversion Varnish: N/A

Paint Match: +\$1687

Finished in Antique Pinewood. Features Six Drawers, Two Wooden shelves with plate grooves. Nine display areas. Also available in any Monogram Finish as M305-18.

Country: CHINA Assembly Req: Y

Also Available:

M305-18 in Custom Finishes at \$8847

4306-18 — Price: \$6747

Pamela Curio Cabinet

Collection: BD COLLECTION FOR FAIRFIELD

Dimensions: 60w × 20d × 84h Weight: 317 / 317 lbs Cube: 65.36

Standard Finish: English Honey Apron Height: N/A

Materials: Ash Solids and Veneers

Highlight Striping: N/A

Contrasting Finishes or Paints: +\$1687

Conversion Varnish: N/A

Paint Match: +\$1687

Finished in English Honey. Features Six Drawers, Two Wooden shelves with plate grooves. Nine display areas. Also available in any Monogram finish as M305-18

Country: CHINA Assembly Req: Y

Also Available:

M305-18 in Custom Finishes at \$8847

4307-18 — Price: \$6087

Edward Curio Cabinet

Collection: BD COLLECTION FOR FAIRFIELD

Dimensions: 48w × 17d × 84h Weight: 328 / 328 lbs Cube: 39.65

Standard Finish: Antique Pinewood Apron Height: N/A

Materials: Ash Solids and Veneers

Highlight Striping: N/A

Contrasting Finishes or Paints: +\$1522

Conversion Varnish: N/A

Paint Match: +\$1522

Finished in Antique Pinewood. Features Three Drawers. Two Glass inset Doors. Two Wooden Shelves.

Country: CHINA Assembly Req: Y

4308-18 — Price: \$6087

Edward Curio Cabinet

Collection: BD COLLECTION FOR FAIRFIELD

Dimensions: 48w × 17d × 84h Weight: 328 / 328 lbs Cube: 39.65

Standard Finish: English Honey Apron Height: N/A

Materials: Ash Solids and Veneers

Highlight Striping: N/A

Contrasting Finishes or Paints: +\$1522

Conversion Varnish: N/A

Paint Match: +\$1522

Finished in English Honey. Features Three Drawers. Two Glass inset Doors. Two Wooden Shelves.

Country: CHINA Assembly Req: Y

4309-18 — Price: \$7887

Alexander Curio Cabinet

Collection: BD COLLECTION FOR FAIRFIELD

Dimensions: 49w × 17.5d × 84.25h Weight: 380 / 380 lbs Cube: 66.6

Standard Finish: Antique Pinewood Apron Height: N/A

Materials: Ash Solids and Veneers

Highlight Striping: N/A

Contrasting Finishes or Paints: +\$1972

Conversion Varnish: N/A

Paint Match: +\$1972

Finished in Antique Pinewood. Features Two Sliding Glass Doors, Two Drawers, 2 Shelves. Also available in any Monogram finish as M309-18

Country: CHINA Assembly Req: Y

Also Available:

M309-18 in Custom Finishes at \$9597

Casegoods

4310-18 — Price: \$7887

Alexander Curio Cabinet

Collection: BD COLLECTION FOR FAIRFIELD

Dimensions: 49w × 17.5d × 84.25h Weight: 380 / 380 lbs Cube: 66.6

Standard Finish: English Honey Apron Height: N/A

Materials: Ash Solids and Veneers

Highlight Striping: N/A

Conversion Varnish: N/A

Contrasting Finishes or Paints: +\$1972

Paint Match: +\$1972

Finished in English Honey. Features Two Sliding Glass Doors, Two Drawers, 2 Shelves. Also available in any Monogram finish as M309-18

Country: CHINA Assembly Req: Y

Also Available:

M309-18 in Custom Finishes at \$9597

4311-18 — Price: \$7737

Alexander Curio Cabinet

Collection: BD COLLECTION FOR FAIRFIELD

Dimensions: 68w × 17.5d × 84.25h Weight: 380 / 380 lbs Cube: 66.61

Standard Finish: Soft White Apron Height: N/A

Materials: Ash Solids and Veneers

Highlight Striping: N/A

Conversion Varnish: N/A

Contrasting Finishes or Paints: +\$1934

Paint Match: +\$1934

Finished in Soft White. Features Two Sliding Glass Doors, Two Drawers, 2 Shelves. Also available in any Monogram Finish as M309-18.

Country: CHINA Assembly Req: Y

Also Available:

M309-18 in Custom Finishes at \$9597

4312-18 — Price: \$6747

Pamela Curio Cabinet

Collection: BD COLLECTION FOR FAIRFIELD

Dimensions: 60w × 20d × 84h Weight: 318 / 318 lbs Cube: 64.41

Standard Finish: Soft White Apron Height: N/A

Materials: Ash Solids and Veneers

Highlight Striping: N/A

Conversion Varnish: N/A

Contrasting Finishes or Paints: +\$1687

Paint Match: +\$1687

Finished in Soft White. Features Six Drawers, Two Wooden shelves with plate grooves. Nine display areas. Also available in any Monogram Finish as M305-18.

Country: CHINA Assembly Req: Y

Also Available:

M305-18 in Custom Finishes at \$8847

4400-TB — Price: \$2037

Garnett Table Base

Collection: BD COLLECTION FOR FAIRFIELD

Dimensions: 30w × 30d × 27.75h Weight: 42 / 42 lbs Cube: 14.45

Standard Finish: Antique Pinewood Apron Height: N/A

Materials: Alder Solids

Highlight Striping: N/A

Conversion Varnish: N/A

Contrasting Finishes or Paints: N/A

Paint Match: +\$509

Also available in any Monogram Finish as M400-TB

Country: CHINA Assembly Req: Y

Also Available:

M400-TB in Custom Finishes at \$2487

4401-TB-A — Price: \$1947

Zoey Table Base

Collection: BD COLLECTION FOR FAIRFIELD

Dimensions: 30w × 30d × 28.75h Weight: 56 / 56 lbs Cube: 9.06

Standard Finish: Antique Pinewood Apron Height: N/A

Materials: Alder Solids

Highlight Striping: N/A

Conversion Varnish: N/A

Contrasting Finishes or Paints: N/A

Paint Match: +\$487

Finished In Antique Pinewood. Also available in any Monogram Finish as M401-TB.

Country: CHINA Assembly Req: N

Also Available:

M401-TB in Custom Finishes at \$2577

4401-TB-E — Price: \$1947

Zoey Table Base

Collection: BD COLLECTION FOR FAIRFIELD

Dimensions: 30w × 30d × 28.75h Weight: 56 / 56 lbs Cube: 9.06

Standard Finish: English Honey Apron Height: N/A

Materials: Alder Solids

Highlight Striping: N/A

Conversion Varnish: N/A

Contrasting Finishes or Paints: N/A

Paint Match: +\$487

Finished In English Honey. Also available in any Monogram Finish as M401-TB.

Country: CHINA Assembly Req: N

Also Available:

M401-TB in Custom Finishes at \$2577

4402-TB-E — Price: \$1287

Sycamore Table Base

Collection: BD COLLECTION FOR FAIRFIELD

Dimensions: 24w × 24d × 28.75h Weight: 46 / 46 lbs Cube: 9.58

Standard Finish: English Honey Apron Height: N/A

Materials: Alder Solids

Highlight Striping: N/A

Conversion Varnish: N/A

Contrasting Finishes or Paints: N/A

Paint Match: +\$322

Finished In English Honey. Also available in any Monogram Finish as M402-TB.

Country: CHINA Assembly Req: N

Also Available:

M402-TB in Custom Finishes at \$1977

4403-TB-A — Price: \$1287

Estelle Table Base

Collection: BD COLLECTION FOR FAIRFIELD

Dimensions: 24w × 24d × 28.75h Weight: 40 / 40 lbs Cube: 5.17

Standard Finish: Antique Pinewood Apron Height: N/A

Materials: Alder Solids

Highlight Striping: N/A

Conversion Varnish: N/A

Contrasting Finishes or Paints: N/A

Paint Match: +\$322

Finished in Antique Pinewood. Also available in any Monogram Finish as M403-TB.

Country: CHINA Assembly Req: N

Also Available:

M403-TB in Custom Finishes at \$1977

Casegoods

4403-TB-E — Price: \$1287

Estelle Table Base

Collection: BD COLLECTION FOR FAIRFIELD

Dimensions: 24w × 24d × 28.75h Weight: 40 / 40 lbs Cube: 5.17

Standard Finish: English Honey Apron Height: N/A

Materials: Alder Solids

Highlight Striping: N/A

Contrasting Finishes or Paints: N/A

Conversion Varnish: N/A

Paint Match: +\$322

Finished in English Honey. Also available in any Monogram Finish as M403-TB.

Country: CHINA Assembly Req: N

Also Available:

M403-TB in Custom Finishes at \$1977

4404-TB-4 — Price: \$1167

Molly Table Base

Collection: BD COLLECTION FOR FAIRFIELD

Dimensions: 24w × 24d × 28.75h Weight: 16 / 16 lbs Cube: 3.84

Standard Finish: Brushed Satin Apron Height: N/A

Materials: Metal

Highlight Striping: N/A

Contrasting Finishes or Paints: N/A

Conversion Varnish: N/A

Paint Match: N/A

Finished in Brushed Satin. Also Available in Antique Gold Finish.

Country: INDIA Assembly Req: N

Also Available:

4404-TB-6 in Antique Gold at \$1167

4404-TB-6 — Price: \$1167

Molly Table Base

Collection: BD COLLECTION FOR FAIRFIELD

Dimensions: 24w × 24d × 28.75h Weight: 16 / 16 lbs Cube: 3.84

Standard Finish: Antique Gold Apron Height: N/A

Materials: Metal

Highlight Striping: N/A

Contrasting Finishes or Paints: N/A

Conversion Varnish: N/A

Paint Match: N/A

Finished in Antique Gold. Also Available in Brushed Satin.

Country: INDIA Assembly Req: N

Also Available:

4404-TB-4 in Brushed Satin at \$1167

4405-TB-4 — Price: \$1077

Daisy Table Base

Collection: BD COLLECTION FOR FAIRFIELD

Dimensions: 22w × 22d × 28.75h Weight: 22 / 22 lbs Cube: 2.94

Standard Finish: Brushed Satin Apron Height: N/A

Materials: Metal

Highlight Striping: N/A

Contrasting Finishes or Paints: N/A

Conversion Varnish: N/A

Paint Match: N/A

Finished in Brushed Satin. Also Available in Antique Gold Finish.

Country: INDIA Assembly Req: N

Also Available:

4405-TB-6 in Antique Gold at \$1077

4405-TB-6 — Price: \$1077

Daisy Table Base

Collection: BD COLLECTION FOR FAIRFIELD

Dimensions: 22w × 22d × 28.75h Weight: 22 / 22 lbs Cube: 2.94

Standard Finish: Antique Gold Apron Height: N/A

Materials: Metal

Highlight Striping: N/A

Contrasting Finishes or Paints: N/A

Conversion Varnish: N/A

Paint Match: N/A

Finished in Antique Gold. Also Available in Brushed Satin.

Country: INDIA Assembly Req: N

Also Available:

4405-TB-4 in Brushed Satin at \$1077

4420-TP-A — Price: \$1227

Elliott Table Top

Collection: BD COLLECTION FOR FAIRFIELD

Dimensions: 36w × 24d × 1.25h Weight: 60 / 60 lbs Cube: 2.49

Standard Finish: Antique Pinewood Apron Height: N/A

Materials: Alder Solids, Calcutta Stone

Highlight Striping: N/A

Contrasting Finishes or Paints: N/A

Conversion Varnish: +\$450

Paint Match: N/A

Finished in Antique Pinewood with Shadow Stone Inset, Eased Edge.

Country: CHINA Assembly Req: N

Also Available:

4420-TP-E in English Honey at \$1227

4420-TP-E — Price: \$1227

Elliott Table Top

Collection: BD COLLECTION FOR FAIRFIELD

Dimensions: 36w × 24d × 1.25h Weight: 60 / 60 lbs Cube: 2.49

Standard Finish: English Honey Apron Height: N/A

Materials: Alder Solids, Calcutta Stone

Highlight Striping: N/A

Contrasting Finishes or Paints: N/A

Conversion Varnish: +\$450

Paint Match: N/A

Finished in English Honey with Shadow Stone Inset, Eased Edge.

Country: CHINA Assembly Req: N

Also Available:

4420-TP-A in Antique Pinewood at \$1227

4421-TP-A — Price: \$1227

Elliott Table Top

Collection: BD COLLECTION FOR FAIRFIELD

Dimensions: 36w × 24d × 1.25h Weight: 60 / 60 lbs Cube: 2.49

Standard Finish: Antique Pinewood Apron Height: N/A

Materials: Alder Solids, Calcutta Stone

Highlight Striping: N/A

Contrasting Finishes or Paints: N/A

Conversion Varnish: +\$450

Paint Match: N/A

Finished in Antique Pinewood with Cottage Stone Inset, Eased Edge.

Country: CHINA Assembly Req: N

Also Available:

4421-TP-E in English Honey at \$1227

Casegoods

4421-TP-E — Price: \$1227

Elliott Table Top

Collection: BD COLLECTION FOR FAIRFIELD

Dimensions: 36w × 24d × 1.25h **Weight:** 60 / 60 lbs **Cube:** 2.49

Standard Finish: English Honey **Apron Height:** N/A

Materials: Alder Solids, Calcutta Stone

Highlight Striping: N/A

Contrasting Finishes or Paints: N/A

Conversion Varnish: +\$450

Paint Match: N/A

Finished in English Honey with Cottage Stone Inset, Eased Edge.

Country: CHINA **Assembly Req:** N

Also Available:

4421-TP-A in Antique Pinewood at \$1227

4424-TP-A — Price: \$597

Karen Table Top

Collection: BD COLLECTION FOR FAIRFIELD

Dimensions: 36w × 24d × 1.25h **Weight:** 37 / 37 lbs **Cube:** 2.52

Standard Finish: Antique Pinewood **Apron Height:** N/A

Materials: Alder Solids and Birch Veneers

Highlight Striping: N/A

Contrasting Finishes or Paints: N/A

Conversion Varnish: +\$450

Paint Match: +\$149

Finished in Antique Pinewood with a Corner Key Design. Eased Edge. Also available in any Monogram Finish as M424-TP.

Country: CHINA **Assembly Req:** N

Also Available:

4424-TP-E in English Honey at \$597

M424-TP in Custom Finishes at \$1977

4424-TP-E — Price: \$597

Karen Table Top

Collection: BD COLLECTION FOR FAIRFIELD

Dimensions: 36w × 24d × 1.25h **Weight:** 37 / 37 lbs **Cube:** 2.52

Standard Finish: English Honey **Apron Height:** N/A

Materials: Alder Solids and Birch Veneers

Highlight Striping: N/A

Contrasting Finishes or Paints: N/A

Conversion Varnish: +\$450

Paint Match: +\$149

Finished in English Honey with a Corner Key Design. Eased Edge. Also available in any Monogram Finish as M424-TP.

Country: CHINA **Assembly Req:** N

Also Available:

4424-TP-A in Antique Pinewood at \$597

M424-TP in Custom Finishes at \$1977

4426-TP-A — Price: \$597

Ava Table Top

Collection: BD COLLECTION FOR FAIRFIELD

Dimensions: 36w × 24d × 1.25h **Weight:** 37 / 37 lbs **Cube:** 2.52

Standard Finish: Antique Pinewood **Apron Height:** N/A

Materials: Alder Solids and Birch Veneers

Highlight Striping: N/A

Contrasting Finishes or Paints: N/A

Conversion Varnish: +\$450

Paint Match: +\$149

Finished in Antique Pinewood with a Quilt Inlay Design. Eased Edge

Country: CHINA **Assembly Req:** N

Also Available:

4426-TP-E in English Honey at \$597

4426-TP-E — Price: \$597

Avah Table Top

Collection: BD COLLECTION FOR FAIRFIELD

Dimensions: 36w × 24d × 1.25h **Weight:** 37 / 37 lbs **Cube:** 2.52

Standard Finish: English Honey **Apron Height:** N/A

Materials: Alder Solids and Birch Veneers

Highlight Striping: N/A

Contrasting Finishes or Paints: N/A

Conversion Varnish: +\$450

Paint Match: +\$149

Finished in English Honey with a Quilt Inlay Design. Eased Edge.

Country: CHINA **Assembly Req:** N

Also Available:

4426-TP-A in Antique Pinewood at \$597

4432-TP-A — Price: \$1557

Ludwig Table Top

Collection: BD COLLECTION FOR FAIRFIELD

Dimensions: 36w × 36d × 1.25h **Weight:** 77 / 77 lbs **Cube:** 3.63

Standard Finish: Antique Pinewood **Apron Height:** N/A

Materials: Alder Solids, Calcutta Stone

Highlight Striping: N/A

Contrasting Finishes or Paints: N/A

Conversion Varnish: N/A

Paint Match: N/A

Finished in Antique Pinewood with Shadow Stone Inset. Eased Edge.

Country: CHINA **Assembly Req:** N

Also Available:

4432-TP-E in English Honey at \$1557

4432-TP-E — Price: \$1557

Ludwig Table Top

Collection: BD COLLECTION FOR FAIRFIELD

Dimensions: 36w × 36d × 1.25h **Weight:** 77 / 77 lbs **Cube:** 3.63

Standard Finish: English Honey **Apron Height:** N/A

Materials: Alder Solids, Calcutta Stone

Highlight Striping: N/A

Contrasting Finishes or Paints: N/A

Conversion Varnish: N/A

Paint Match: N/A

Finished in English Honey with Shadow Stone Inset. Eased Edge.

Country: CHINA **Assembly Req:** N

Also Available:

4432-TP-A in Antique Pinewood at \$1557

4433-TP-A — Price: \$1557

Ludwig Table Top

Collection: BD COLLECTION FOR FAIRFIELD

Dimensions: 36w × 36d × 1.25h **Weight:** 45 / 45 lbs **Cube:** 0.93

Standard Finish: Antique Pinewood **Apron Height:** N/A

Materials: Alder Solids, Calcutta Stone

Highlight Striping: N/A

Contrasting Finishes or Paints: N/A

Conversion Varnish: N/A

Paint Match: N/A

Finished in Antique Pinewood with Cottage Stone Inset. Eased Edge.

Country: CHINA **Assembly Req:** N

Also Available:

4433-TP-E in English Honey at \$1557

Casegoods

4433-TP-E — Price: \$1557

Ludwig Table Top

Collection: BD COLLECTION FOR FAIRFIELD

Dimensions: 36w × 36d × 1.25h Weight: 45 / 45 lbs Cube: 0.93

Standard Finish: English Honey Apron Height: N/A

Materials: Alder Solids, Calcutta Stone

Highlight Striping: N/A

Contrasting Finishes or Paints: N/A

Conversion Varnish: N/A

Paint Match: N/A

Finished in English Honey with Cottage Stone Inset. Eased Edge.

Country: CHINA Assembly Req: N

Also Available:

4433-TP-A in Antique Pinewood at \$1557

4434-TP — Price: \$1287

Archie Table Top

Collection: BD COLLECTION FOR FAIRFIELD

Dimensions: 36w × 36d × 1.25h Weight: 71 / 71 lbs Cube: 0.93

Standard Finish: Apron Height: N/A

Materials: Stone

Highlight Striping: N/A

Contrasting Finishes or Paints: N/A

Conversion Varnish: N/A

Paint Match: N/A

Shadow Stone Top.

Country: CHINA Assembly Req: N

4435-TP — Price: \$1287

Anne Table Top

Collection: BD COLLECTION FOR FAIRFIELD

Dimensions: 36w × 36d × 1.25h Weight: 71 / 71 lbs Cube: 0.93

Standard Finish: Apron Height: N/A

Materials: Stone

Highlight Striping: N/A

Contrasting Finishes or Paints: N/A

Conversion Varnish: N/A

Paint Match: N/A

Cottage Stone Top.

Country: CHINA Assembly Req: N

4440-TP-A — Price: \$1917

Carlisle Table Top

Collection: BD COLLECTION FOR FAIRFIELD

Dimensions: 42w × 42d × 1.25h Weight: 122 / 122 lbs Cube: 1.27

Standard Finish: Antique Pinewood Apron Height: N/A

Materials: Alder Solids, Calcutta Stone

Highlight Striping: N/A

Contrasting Finishes or Paints: N/A

Conversion Varnish: N/A

Paint Match: N/A

Finished in Antique Pinewood with Shadow Stone Inset. Eased Edge.

Country: CHINA Assembly Req: N

Also Available:

4440-TP-E in English Honey at \$1917

4440-TP-E — Price: \$1917

Carlisle Table Top

Collection: BD COLLECTION FOR FAIRFIELD

Dimensions: 42w × 42d × 1.25h Weight: 122 / 122 lbs Cube: 1.27

Standard Finish: English Honey Apron Height: N/A

Materials: Alder Solids, Calcutta Stone

Highlight Striping: N/A

Contrasting Finishes or Paints: N/A

Conversion Varnish: N/A

Paint Match: N/A

Finished in English Honey with Shadow Stone Inset. Eased Edge.

Country: CHINA Assembly Req: N

Also Available:

4440-TP-A in Antique Pinewood at \$1917

4441-TP-A — Price: \$1917

Carlisle Table Top

Collection: BD COLLECTION FOR FAIRFIELD

Dimensions: 42w × 42d × 1.25h Weight: 122 / 122 lbs Cube: 1.27

Standard Finish: Antique Pinewood Apron Height: N/A

Materials: Alder Solids, Calcutta Stone

Highlight Striping: N/A

Contrasting Finishes or Paints: N/A

Conversion Varnish: N/A

Paint Match: N/A

Finished in Antique Pinewood with Cottage Stone Inset. Eased Edge.

Country: CHINA Assembly Req: N

Also Available:

4441-TP-E in English Honey at \$1917

4441-TP-E — Price: \$1917

Carlisle Table Top

Collection: BD COLLECTION FOR FAIRFIELD

Dimensions: 42w × 42d × 1.25h Weight: 122 / 122 lbs Cube: 1.27

Standard Finish: English Honey Apron Height: N/A

Materials: Alder Solids, Calcutta Stone

Highlight Striping: N/A

Contrasting Finishes or Paints: N/A

Conversion Varnish: N/A

Paint Match: N/A

Finished in English Honey with Cottage Stone Inset. Eased Edge.

Country: CHINA Assembly Req: N

Also Available:

4441-TP-A in Antique Pinewood at \$1917

4442-TP — Price: \$897

Hayden Table Top

Collection: BD COLLECTION FOR FAIRFIELD

Dimensions: 42w × 42d × 1.25h Weight: 139 / 139 lbs Cube: 4.73

Standard Finish: Coal Apron Height: N/A

Materials: Laminated and Alder Solids

Highlight Striping: N/A

Contrasting Finishes or Paints: N/A

Conversion Varnish: N/A

Paint Match: N/A

Finished in Coal Finish with Eased Edge.

Country: CHINA Assembly Req: N

Casegoods

4443-TP — Price: \$897

Samuel Table Top

Collection: BD COLLECTION FOR FAIRFIELD

Dimensions: 42w × 42d × 1.25h **Weight:** 122 / 122 lbs **Cube:** 1.27

Standard Finish: Perfect Walnut **Apron Height:** N/A

Materials: Laminated and Alder Solids

Highlight Striping: N/A

Contrasting Finishes or Paints: N/A

Conversion Varnish: N/A

Paint Match: N/A

Finished in Perfect Walnut Finish with Eased Edge.

Country: CHINA **Assembly Req:** N

4444-TP-A — Price: \$957

Karen Table Top

Collection: BD COLLECTION FOR FAIRFIELD

Dimensions: 42w × 42d × 1.25h **Weight:** 75 / 75 lbs **Cube:** 1.27

Standard Finish: Antique Pinewood **Apron Height:** N/A

Materials: Alder Solids and Birch Veneers

Highlight Striping: N/A

Contrasting Finishes or Paints: N/A

Conversion Varnish: +\$450

Paint Match: +\$239

Finished in Antique Pinewood with a Corner Key Design. Eased Edge. Also available in any Monogram Finish as M444-TP.

Country: CHINA **Assembly Req:** N

Also Available:

4444-TP-E in English Honey at \$957

M444-TP in Custom Finishes at \$1977

4444-TP-E — Price: \$957

Karen Table Top

Collection: BD COLLECTION FOR FAIRFIELD

Dimensions: 42w × 42d × 1.25h **Weight:** 75 / 75 lbs **Cube:** 1.27

Standard Finish: English Honey **Apron Height:** N/A

Materials: Alder Solids and Birch Veneers

Highlight Striping: N/A

Contrasting Finishes or Paints: N/A

Conversion Varnish: +\$450

Paint Match: +\$239

Finished in English Honey with a Corner Key Design. Eased Edge. Also available in any Monogram Finish as M444-TP.

Country: CHINA **Assembly Req:** N

Also Available:

4444-TP-A in Antique Pinewood at \$957

M444-TP in Custom Finishes at \$1977

4446-TP-A — Price: \$957

Ava Table Top

Collection: BD COLLECTION FOR FAIRFIELD

Dimensions: 42w × 42d × 1.25h **Weight:** 90 / 90 lbs **Cube:** 4.73

Standard Finish: Antique Pinewood **Apron Height:** N/A

Materials: Alder Solids and Birch Veneers

Highlight Striping: N/A

Contrasting Finishes or Paints: N/A

Conversion Varnish: +\$450

Paint Match: +\$239

Finished in Antique Pinewood with a Quilt Inlay Design. Eased Edge. Also available in any Monogram Finish as M446-TP.

Country: CHINA **Assembly Req:** N

Also Available:

4446-TP-E in English Honey at \$957

M446-TP in Custom Finishes at \$2097

4446-TP-E — Price: \$957

Ava Table Top

Collection: BD COLLECTION FOR FAIRFIELD

Dimensions: 42w × 42d × 1.25h **Weight:** 90 / 90 lbs **Cube:** 4.73

Standard Finish: English Honey **Apron Height:** N/A

Materials: Alder Solids and Birch Veneers

Highlight Striping: N/A

Contrasting Finishes or Paints: N/A

Conversion Varnish: +\$450

Paint Match: +\$239

Finished in English Honey with a Quilt Inlay Design. Eased Edge. Also available in any Monogram Finish as M446-TP.

Country: CHINA **Assembly Req:** N

Also Available:

4446-TP-A in Antique Pinewood at \$957

M446-TP in Custom Finishes at \$2097

4450-86 — Price: \$4434

Garnett Activity Table

Collection: BD COLLECTION FOR FAIRFIELD

Dimensions: 42w × 42d × 32.25h **Weight:** 150 / 150 lbs **Cube:** 32.92

Standard Finish: Antique Pinewood **Apron Height:** N/A

Materials: Alder Solids

Highlight Striping: N/A

Contrasting Finishes or Paints: N/A

Conversion Varnish: +\$665

Paint Match: +\$1109

Features an Olive faux-leather activity table top. Features pull-out drink holders on each side.

Country: CHINA **Assembly Req:** N

4452-86 — Price: \$2487

Jess Puzzle Activity Table

Collection: BD COLLECTION FOR FAIRFIELD

Dimensions: 54w × 31d × 30.5h **Weight:** 66 / 66 lbs **Cube:** 29.54

Standard Finish: English Honey **Apron Height:** 26

Materials: Alder Solids

Highlight Striping: N/A

Contrasting Finishes or Paints: N/A

Conversion Varnish: N/A

Paint Match: +\$622

Features two drawers on each side with storage and a work surface in 3109 Flax. 48" inside width from leg to leg

Country: CHINA **Assembly Req:** Y

Also Available:

M452-86 in Custom Finishes at \$2997

4463-TP-A — Price: \$2067

Carol Table Top

Collection: BD COLLECTION FOR FAIRFIELD

Dimensions: 60w × 60d × 1.25h **Weight:** 122 / 122 lbs **Cube:** 9.55

Standard Finish: Antique Pinewood **Apron Height:** N/A

Materials: Alder Solids and Birch Veneers

Highlight Striping: N/A

Contrasting Finishes or Paints: N/A

Conversion Varnish: +\$450

Paint Match: +\$517

Finished in Antique Pinewood with a Herringbone Design. Ogee Edge. Also available in any Monogram Finish as M463-TP.

Country: CHINA **Assembly Req:** N

Also Available:

4463-TP-E in English Honey at \$2067

M463-TP in Custom Finishes at \$3207

Casegoods

4463-TP-E — Price: \$2067

Carol Table Top

Collection: BD COLLECTION FOR FAIRFIELD

Dimensions: 60w × 60d × 1.25h **Weight:** 122 / 122 lbs **Cube:** 9.55

Standard Finish: English Honey **Apron Height:** N/A

Materials: Alder Solids and Birch Veneers

Highlight Striping: N/A

Contrasting Finishes or Paints: N/A

Conversion Varnish: +\$450

Paint Match: +\$517

Finished in English Honey with a Herringbone Design. Ogee Edge

Country: CHINA **Assembly Req:** N

Also Available:

4463-TP-A in Antique Pinewood at \$2067

M463-TP in Custom Finishes at \$3207

4464-TP-A — Price: \$2067

Avah Table Top

Collection: BD COLLECTION FOR FAIRFIELD

Dimensions: 60w × 60d × 1.25h **Weight:** 122 / 122 lbs **Cube:** 9.4

Standard Finish: Antique Pinewood **Apron Height:** N/A

Materials: Alder Solids and Birch Veneers

Highlight Striping: N/A

Contrasting Finishes or Paints: N/A

Conversion Varnish: +\$450

Paint Match: +\$517

Finished in Antique Pinewood with a Quilt Inlay Design. Ogee Edge.

Country: CHINA **Assembly Req:** N

Also Available:

4464-TP-E in English Honey at \$2067

M464-TP in Custom Finishes at \$3207

4464-TP-E — Price: \$2067

Ava Table Top

Collection: BD COLLECTION FOR FAIRFIELD

Dimensions: 60w × 60d × 1.25h **Weight:** 122 / 122 lbs **Cube:** 9.4

Standard Finish: English Honey **Apron Height:** N/A

Materials: Alder Solids and Birch Veneers

Highlight Striping: N/A

Contrasting Finishes or Paints: N/A

Conversion Varnish: +\$450

Paint Match: +\$517

Finished in English Honey with a Quilt Inlay Design. Ogee Edge. Also available in any Monogram Finish as M464-TP.

Country: CHINA **Assembly Req:** N

Also Available:

4464-TP-A in Antique Pinewood at \$2067

M464-TP in Custom Finishes at \$3207

6308-13 — Price: \$1497

Marlowe Tiered Round Cocktail Table

Collection: LIBBY LANGDON FOR FAIRFIELD

Dimensions: 42w × 42d × 18h **Weight:** 77 / 77 lbs **Cube:** 18.37

Standard Finish: Smoked Stone **Apron Height:** N/A

Materials: Stainless Steel, Walnut Solids and Veneers

Highlight Striping: N/A

Contrasting Finishes or Paints: N/A

Conversion Varnish: +\$450

Paint Match: +\$374

Features one top with Walnut veneers and a lower antique mirror shelf, Smoked Stone and Champagne Metal. Also available in any Monogram Finish as M308-13.

Country: CHINA **Assembly Req:** N

Also Available:

M308-13 in Custom Finishes at \$2247

6308-ET — Price: \$1347

Marlowe Tiered Round End Table

Collection: LIBBY LANGDON FOR FAIRFIELD

Dimensions: 26w × 26d × 25h **Weight:** 51 / 51 lbs **Cube:** 9.78

Standard Finish: Smoked Stone **Apron Height:** N/A

Materials: Stainless Steel, Walnut Solids and Veneers

Highlight Striping: N/A

Contrasting Finishes or Paints: N/A

Conversion Varnish: +\$450

Paint Match: +\$337

Features one top with Walnut veneers and a lower antique mirror shelf, Smoked Stone Finish and Champagne Metal. Also available in any Monogram Finish as M308-ET.

Country: CHINA **Assembly Req:** N

Also Available:

M308-ET in Custom Finishes at \$1947

6309-CS — Price: \$987

Kylie Drink Table

Collection: LIBBY LANGDON FOR FAIRFIELD

Dimensions: 16w × 16d × 22h **Weight:** 8 / 8 lbs **Cube:** 3.25

Standard Finish: Champagne **Apron Height:** N/A

Materials: Metal and Antique Glass

Highlight Striping: N/A

Contrasting Finishes or Paints: N/A

Conversion Varnish: N/A

Paint Match: N/A

Features Antique Mirror glass and Champagne Metal.

Country: INDIA **Assembly Req:** N

6310-BC — Price: \$1347

Wayne End Table

Collection: LIBBY LANGDON FOR FAIRFIELD

Dimensions: 24w × 24d × 24h **Weight:** 69 / 69 lbs **Cube:** 8

Standard Finish: Dark Sable **Apron Height:** N/A

Materials: Onyx Stone Top, Mango Solids and Metal Accents

Highlight Striping: N/A

Contrasting Finishes or Paints: N/A

Conversion Varnish: N/A

Paint Match: +\$337

Country: INDIA **Assembly Req:** Y

6315-19 — Price: \$837

Zeller End Table

Collection: LIBBY LANGDON FOR FAIRFIELD

Dimensions: 24w × 24d × 24h **Weight:** 32 / 32 lbs **Cube:** 2.79

Standard Finish: Cerused Espresso **Apron Height:** N/A

Materials: Stainless Steel, Ash Solids and Veneers

Highlight Striping: N/A

Contrasting Finishes or Paints: N/A

Conversion Varnish: +\$450

Paint Match: +\$209

Also available in any Monogram Finish as M315-19.

Country: CHINA **Assembly Req:** N

Also Available:

M315-19 in Custom Finishes at \$1497

Casegoods

6316-96 — Price: \$2007

Simone Writing Desk

Collection: LIBBY LANGDON FOR FAIRFIELD

Dimensions: 60w × 22d × 30h Weight: 96 / 96 lbs Cube: 7.66

Standard Finish: Smoked Stone Apron Height: N/A

Materials: Stainless Steel, Acrylic, Walnut Solids and Veneers

Highlight Striping: N/A

Contrasting Finishes or Paints: +\$502

Conversion Varnish: +\$450

Paint Match: +\$502

Features two drawers with soft close guides. Also available in any Monogram Finish as M316-96.

Country: CHINA Assembly Req: Y

Also Available:

M316-96 in Custom Finishes at \$2847

6317-DT — Price: \$2847

Clement Dining Table

Collection: LIBBY LANGDON FOR FAIRFIELD

Dimensions: 76w × 40d × 30h Weight: 263 / 263 lbs Cube: 22.01

Standard Finish: Smoked Stone Apron Height: N/A

Materials: Stainless Steel, Oak Solids and Eucalyptus Veneers

Highlight Striping: N/A

Contrasting Finishes or Paints: N/A

Conversion Varnish: +\$450

Paint Match: +\$712

Features one 24" filler. Also available in any Monogram Finish as M317-DT.

Country: CHINA Assembly Req: Y

Also Available:

M317-DT in Custom Finishes at \$3897

6320-88 — Price: \$747

Rosso Drink Table

Collection: LIBBY LANGDON FOR FAIRFIELD

Dimensions: 14w × 14d × 22.25h Weight: 19 / 19 lbs Cube: 2.51

Standard Finish: Smoked Stone Apron Height: N/A

Materials: Stainless Steel and Marquina Stone

Highlight Striping: N/A

Contrasting Finishes or Paints: N/A

Conversion Varnish: N/A

Paint Match: N/A

Country: INDIA Assembly Req: Y

6321-88 — Price: \$987

Mangold Drink Table

Collection: LIBBY LANGDON FOR FAIRFIELD

Dimensions: 11w × 11d × 24h Weight: 11 / 11 lbs Cube: 1.68

Standard Finish: Champagne Apron Height: N/A

Materials: Glass, Stainless Steel

Highlight Striping: N/A

Contrasting Finishes or Paints: N/A

Conversion Varnish: N/A

Paint Match: N/A

Country: CHINA Assembly Req: Y

6322-17 — Price: \$2997

Farley Six Drawer Chest

Collection: LIBBY LANGDON FOR FAIRFIELD

Dimensions: 78w × 20d × 37h Weight: 293 / 293 lbs Cube: 33.4

Standard Finish: Smoked Stone Apron Height: N/A

Materials: Walnut Solids and Veneers

Highlight Striping: N/A

Contrasting Finishes or Paints: +\$749

Conversion Varnish: +\$450

Paint Match: +\$749

Features six full extension drawers with nickel hardware. Also available in any Monogram Finish as M322-17.

Country: VIETNAM Assembly Req: N

Also Available:

M322-17 in Custom Finishes at \$4197

6322-38 — Price: \$1797

Farley Nightstand

Collection: LIBBY LANGDON FOR FAIRFIELD

Dimensions: 36w × 20d × 28h Weight: 141 / 141 lbs Cube: 11.66

Standard Finish: Smoked Stone Apron Height: N/A

Materials: Walnut Solids and Veneers

Highlight Striping: N/A

Contrasting Finishes or Paints: +\$449

Conversion Varnish: +\$450

Paint Match: +\$449

Features two full extension drawers with nickel hardware. Also available in any Monogram Finish as M322-38.

Country: VIETNAM Assembly Req: N

Also Available:

M322-38 in Custom Finishes at \$2997

6322-CH — Price: \$2397

Farley Five Drawer Chest

Collection: LIBBY LANGDON FOR FAIRFIELD

Dimensions: 36w × 20d × 55h Weight: 222 / 222 lbs Cube: 22.91

Standard Finish: Smoked Stone Apron Height: N/A

Materials: Walnut Solids and Veneers

Highlight Striping: N/A

Contrasting Finishes or Paints: +\$599

Conversion Varnish: +\$450

Paint Match: +\$599

Features five extension drawers with nickel hardware. Also available in any Monogram Finish as M322-CH.

Country: VIETNAM Assembly Req: N

Also Available:

M322-CH in Custom Finishes at \$3807

6322-ET — Price: \$1647

Farley Nightstand

Collection: LIBBY LANGDON FOR FAIRFIELD

Dimensions: 28w × 20d × 28h Weight: 108 / 108 lbs Cube: 9.07

Standard Finish: Smoked Stone Apron Height: N/A

Materials: Walnut Solids and Veneers

Highlight Striping: N/A

Contrasting Finishes or Paints: +\$412

Conversion Varnish: +\$450

Paint Match: +\$412

Features three full extension drawers with nickel hardware. Also available in any Monogram Finish as M322-ET.

Country: VIETNAM Assembly Req: N

Also Available:

M322-ET in Custom Finishes at \$2697

Casegoods

6322-KB — Price: \$3597

Farley King Bed

Collection: LIBBY LANGDON FOR FAIRFIELD

Dimensions: 80w × 84d × 67h **Weight:** 320 / 320 lbs **Cube:** 260.55

Standard Finish: Smoked Stone **Apron Height:** N/A

Materials: Walnut Solids and Veneers

Highlight Striping: N/A

Contrasting Finishes or Paints: N/A

Conversion Varnish: N/A

Paint Match: N/A

Features nickel ferrules and nickel beaded accents. A box-spring is not required for this bed.

Country: VIETNAM **Assembly Req:** Y

Also Available:

M322-KB in Custom Finishes at \$4197

6322-QB — Price: \$3297

Farley Queen Bed

Collection: LIBBY LANGDON FOR FAIRFIELD

Dimensions: 64w × 84d × 67h **Weight:** 254 / 254 lbs **Cube:** 208.44

Standard Finish: Smoked Stone **Apron Height:** N/A

Materials: Walnut Solids and Veneers

Highlight Striping: N/A

Contrasting Finishes or Paints: N/A

Conversion Varnish: N/A

Paint Match: N/A

Features nickel ferrules and nickel beaded accents. A box-spring is not required for this bed.

Country: VIETNAM **Assembly Req:** Y

Also Available:

M322-QB in Custom Finishes at \$3897

6323-TB — Price: \$2247

Ellerson Dining Table Base

Collection: LIBBY LANGDON FOR FAIRFIELD

Dimensions: 45w × 22d × 28.5h **Weight:** 82 / 82 lbs **Cube:** 17.16

Standard Finish: Nickel **Apron Height:** N/A

Materials: Stainless Steel

Highlight Striping: N/A

Contrasting Finishes or Paints: N/A

Conversion Varnish: N/A

Paint Match: N/A

Country: INDIA **Assembly Req:** Y

6331-81 — Price: \$2847

Hillside Desk

Collection: LIBBY LANGDON FOR FAIRFIELD

Dimensions: 56w × 26d × 30h **Weight:** 200 / 200 lbs **Cube:** 25.27

Standard Finish: Smoked Stone **Apron Height:** N/A

Materials: Ash Solids and Veneers

Highlight Striping: +\$450

Contrasting Finishes or Paints: +\$712

Conversion Varnish: +\$450

Paint Match: +\$712

Features Three soft close drawers with hardware wrapped in 4927-73 Quartz and Champagne brass accents. Smoke Stone Finish with Linen Finish on drawers and boarder. Also available in any Fairfield Finish as M331-81

Country: CHINA **Assembly Req:** N

Also Available:

M331-81 in Custom Finishes at \$4047

6332-17 — Price: \$3447

Hempstead Credenza

Collection: LIBBY LANGDON FOR FAIRFIELD

Dimensions: 72w × 18d × 36h **Weight:** 105 / 105 lbs **Cube:** 27

Standard Finish: Dark Sable **Apron Height:** N/A

Materials: Walnut Solids and Veneers

Highlight Striping: N/A

Contrasting Finishes or Paints: N/A

Conversion Varnish: +\$517

Paint Match: N/A

Features four doors with one interior adjustable shelf behind each door. Door fronts and hardware are wrapped in 4927-73 Quartz with Champagne Brass accents and base. Exterior Finish is in Dark Sable.

Country: CHINA **Assembly Req:** N

6332-38 — Price: \$2097

Hempstead Chest

Collection: LIBBY LANGDON FOR FAIRFIELD

Dimensions: 36w × 18d × 36h **Weight:** 215 / 215 lbs **Cube:** 13.5

Standard Finish: Dark Sable **Apron Height:** N/A

Materials: Walnut Solids and Veneers

Highlight Striping: N/A

Contrasting Finishes or Paints: N/A

Conversion Varnish: +\$450

Paint Match: N/A

Features two doors with one interior adjustable shelf. Door fronts and hardware are wrapped in 4927-73 Quartz with Champagne Brass accents and base. Exterior Finish is in Dark Sable.

Country: CHINA **Assembly Req:** N

6700-TC — Price: \$2697

Randall Tier Cocktail

Collection: LIBBY LANGDON FOR FAIRFIELD

Dimensions: 28w × 36d × 19h **Weight:** 96 / 96 lbs **Cube:** 20.1

Standard Finish: Cerused Espresso **Apron Height:** N/A

Materials: Walnut Solids & Veneers

Highlight Striping: N/A

Contrasting Finishes or Paints: N/A

Conversion Varnish: N/A

Paint Match: +\$674

Polished Nickel metal frame, top shelf: glass, middle shelf: White Carrara Stone, bottom shelf: wood with one side finished in Cerused Espresso and one side finished in Sheer Dove.

Country: CHINA **Assembly Req:** N

6701-92 — Price: \$2037

Peconic Square Cocktail Table

Collection: LIBBY LANGDON FOR FAIRFIELD

Dimensions: 40w × 40d × 18h **Weight:** 75 / 75 lbs **Cube:** 23

Standard Finish: Sheer Dove **Apron Height:** N/A

Materials: Quartered Ash Solids & Veneers

Highlight Striping: N/A

Contrasting Finishes or Paints: N/A

Conversion Varnish: +\$450

Paint Match: +\$509

Finished in Sheer Dove. Also available in any Monogram Finish as M701-92.

Country: CHINA **Assembly Req:** N

Also Available:

M701-92 in Custom Finishes at \$2847

Casegoods

6702-93 — Price: \$2037

Dune Rectangular Cocktail Table

Collection: LIBBY LANGDON FOR FAIRFIELD

Dimensions: 48w × 28d × 18h Weight: 149 / 149 lbs Cube: 18.9

Standard Finish: White Lacquer Apron Height: N/A

Materials: Quartered Ash Solids & Veneers

Highlight Striping: N/A

Contrasting Finishes or Paints: N/A

Conversion Varnish: +\$450

Paint Match: +\$509

Finished in White Lacquer with one fixed shelf.

Country: CHINA Assembly Req: N

6703-12 — Price: \$2307

Gansett Nesting Cocktail Table

Collection: LIBBY LANGDON FOR FAIRFIELD

Dimensions: 48w × 28d × 19h Weight: 123 / 123 lbs Cube: 20.12

Standard Finish: Dark Sable Apron Height: N/A

Materials: Ash Solids

Highlight Striping: N/A

Contrasting Finishes or Paints: N/A

Conversion Varnish: N/A

Paint Match: +\$577

Large table: glass top. Small table: White Carrara Stone top. Dark Sable wood finish.

Country: CHINA Assembly Req: N

Also Available:

M703-12 in Custom Finishes at \$3147

6721-47 — Price: \$1437

Wheelock End Table

Collection: LIBBY LANGDON FOR FAIRFIELD

Dimensions: 28w × 22d × 24h Weight: 37 / 37 lbs Cube: 12

Standard Finish: Sheer Dove Apron Height: N/A

Materials: Quartered Ash Solids & Veneers

Highlight Striping: N/A

Contrasting Finishes or Paints: N/A

Conversion Varnish: +\$450

Paint Match: +\$359

Oval wood top finished in Sheer Dove with a curved, metal base in Dark Bronze. Also available in any Monogram Finish as M721-47.

Country: CHINA Assembly Req: N

Also Available:

M721-47 in Custom Finishes at \$2007

6722-19 — Price: \$1497

Oakleigh End Table

Collection: LIBBY LANGDON FOR FAIRFIELD

Dimensions: 28w × 28d × 24h Weight: 46 / 46 lbs Cube: 3.89

Standard Finish: Dark Sable Apron Height: N/A

Materials: Birch Solids & Walnut Veneers

Highlight Striping: N/A

Contrasting Finishes or Paints: N/A

Conversion Varnish: +\$450

Paint Match: +\$374

Dark Sable finish. Also available in any Monogram Finish as M722-19.

Country: CHINA Assembly Req: N

Also Available:

M722-19 in Custom Finishes at \$2697

6723-37 — Price: \$1887

Foster Left Side Facing Open End Table

Collection: LIBBY LANGDON FOR FAIRFIELD

Dimensions: 30w × 20d × 26h Weight: 114 / 114 lbs Cube: 12.48

Standard Finish: Dark Sable Apron Height: N/A

Materials: Birch Solids & Walnut Veneers

Highlight Striping: N/A

Contrasting Finishes or Paints: N/A

Conversion Varnish: +\$450

Paint Match: +\$472

Finished in Dark Sable with one soft-close drawer, two fixed shelves. Also available in any Monogram Finish as M723-37.

Country: CHINA Assembly Req: N

Also Available:

M723-37 in Custom Finishes at \$2787

6724-ET — Price: \$1797

Redfield End Table

Collection: LIBBY LANGDON FOR FAIRFIELD

Dimensions: 27w × 15d × 25h Weight: 60 / 60 lbs Cube: 8.68

Standard Finish: Apron Height: N/A

Materials: Polished Nickel Stainless Steel with Black Stone Top

Highlight Striping: N/A

Contrasting Finishes or Paints: N/A

Conversion Varnish: N/A

Paint Match: N/A

Polished Nickel base with a black Granite top.

Country: CHINA Assembly Req: N

6725-95 — Price: \$1737

Gibson End Table

Collection: LIBBY LANGDON FOR FAIRFIELD

Dimensions: 24w × 24d × 24h Weight: 76 / 76 lbs Cube: 11.39

Standard Finish: Dark Sable Apron Height: N/A

Materials: Quartered Ash Solids & Veneers

Highlight Striping: N/A

Contrasting Finishes or Paints: N/A

Conversion Varnish: +\$450

Paint Match: +\$434

Finished in Dark Sable with one soft-close drawer, one fixed shelf and a fluted, brushed brass pull. Also available in any Monogram Finish as M725-95.

Country: CHINA Assembly Req: N

Also Available:

M725-95 in Custom Finishes at \$2697

6726-TE — Price: \$687

Jayden Chairside Table

Collection: LIBBY LANGDON FOR FAIRFIELD

Dimensions: 18w × 14d × 22h Weight: 0 / 0 lbs Cube: 0

Standard Finish: Champagne Apron Height: N/A

Materials: Metal & Carrara Marble

Highlight Striping: N/A

Contrasting Finishes or Paints: N/A

Conversion Varnish: N/A

Paint Match: N/A

Champagne finished metal frame. Top shelf is glass, lower shelf is Carrara Marble.

Country: INDIA Assembly Req: N

Casegoods

6727-CS — Price: \$687

Rogers Chairside Table

Collection: LIBBY LANGDON FOR FAIRFIELD

Dimensions: 16w × 16d × 24h Weight: 38 / 38 lbs Cube: 5.62

Standard Finish: Champagne Apron Height: N/A

Materials: Metal & Carrara Marble

Highlight Striping: N/A

Contrasting Finishes or Paints: N/A

Conversion Varnish: N/A

Paint Match: N/A

Champagne finished metal frame with a white, Carrara Marble top.

Country: INDIA Assembly Req: N

6730-95 — Price: \$957

Michaela Drink Table

Collection: LIBBY LANGDON FOR FAIRFIELD

Dimensions: 20w × 12d × 24h Weight: 41 / 41 lbs Cube: 5.7

Standard Finish: Modern Truffle Apron Height: N/A

Materials: Mango Solids, Metal

Highlight Striping: N/A

Contrasting Finishes or Paints: N/A

Conversion Varnish: +\$450

Paint Match: +\$239

Finished in Modern Truffle with Brushed Champagne metal accents. Features one drawer and one hidden drop-lid storage compartment.

Country: INDIA Assembly Req: N

6740-17-M — Price: \$5697

Heatherwood Master Chest

Collection: LIBBY LANGDON FOR FAIRFIELD

Dimensions: 76w × 20d × 36h Weight: 287 / 287 lbs Cube: 40.74

Standard Finish: Modern Truffle Apron Height: N/A

Materials: Walnut Solids & Veneers

Highlight Striping: N/A

Contrasting Finishes or Paints: +\$1424

Conversion Varnish: +\$855

Paint Match: +\$1424

Finished in Modern Truffle with Polished Nickel accents and nine, soft-close drawers.

Country: CHINA Assembly Req: N

Also Available:

6740-17-S in Sheer Dove at \$5697

M740-17 in Custom Finishes at \$6687

6740-17-S — Price: \$5697

Heatherwood Master Chest

Collection: LIBBY LANGDON FOR FAIRFIELD

Dimensions: 76w × 20d × 36h Weight: 287 / 287 lbs Cube: 40.74

Standard Finish: Sheer Dove Apron Height: N/A

Materials: Walnut Solids and Veneers

Highlight Striping: N/A

Contrasting Finishes or Paints: +\$1424

Conversion Varnish: +\$855

Paint Match: +\$1424

Finished in Sheer Dove with Polished Nickel accents and nine, soft-close drawers. Also available in any Monogram Finish as M740-17.

Country: CHINA Assembly Req: N

Also Available:

6740-17-M in Modern Truffle at \$5697

M740-17 in Custom Finishes at \$6687

6740-38-S — Price: \$2787

Heatherwood Large End Table

Collection: LIBBY LANGDON FOR FAIRFIELD

Dimensions: 38w × 20d × 32h Weight: 135 / 135 lbs Cube: 18.89

Standard Finish: Sheer Dove Apron Height: N/A

Materials: Walnut Solids and Veneers

Highlight Striping: N/A

Contrasting Finishes or Paints: +\$697

Conversion Varnish: +\$450

Paint Match: +\$697

Finished in Sheer Dove with Polished Nickel accents, and two soft-close drawers. The top drawer features an electrical outlet with two USB ports. Also available in any Monogram Finish as M740-38.

Country: CHINA Assembly Req: N

Also Available:

M740-38 in Custom Finishes at \$3777

6740-CH-M — Price: \$3957

Heatherwood Chest

Collection: LIBBY LANGDON FOR FAIRFIELD

Dimensions: 60w × 20d × 36h Weight: 164 / 164 lbs Cube: 32.7

Standard Finish: Modern Truffle Apron Height: N/A

Materials: Walnut Solids & Veneers

Highlight Striping: N/A

Contrasting Finishes or Paints: +\$989

Conversion Varnish: +\$594

Paint Match: +\$989

Finished in Modern Truffle with Polished Nickel accents and six, soft-close drawers. Also available in any Monogram Finish as M740-CH.

Country: CHINA Assembly Req: N

Also Available:

6740-CH-S in Sheer Dove at \$3957

M740-CH in Custom Finishes at \$5457

6740-CH-S — Price: \$3957

Heatherwood Chest

Collection: LIBBY LANGDON FOR FAIRFIELD

Dimensions: 60w × 20d × 36h Weight: 164 / 164 lbs Cube: 32.7

Standard Finish: Sheer Dove Apron Height: N/A

Materials: Walnut Solids and Veneers

Highlight Striping: N/A

Contrasting Finishes or Paints: +\$989

Conversion Varnish: +\$594

Paint Match: +\$989

Finished in Sheer Dove with Polished Nickel accents and six, soft-close drawers. Also available in any Monogram Finish as M740-CH.

Country: CHINA Assembly Req: N

Also Available:

6740-CH-M in Modern Truffle at \$3957

M740-CH in Custom Finishes at \$5457

6740-ET-M — Price: \$2157

Heatherwood End Table

Collection: LIBBY LANGDON FOR FAIRFIELD

Dimensions: 34w × 20d × 28h Weight: 87 / 87 lbs Cube: 15.26

Standard Finish: Modern Truffle Apron Height: N/A

Materials: Walnut Solids & Veneers

Highlight Striping: N/A

Contrasting Finishes or Paints: +\$539

Conversion Varnish: +\$450

Paint Match: +\$539

Finished in Modern Truffle with Polished Nickel accents and two, soft-close drawers. Also available in any Monogram Finish as M740-ET.

Country: CHINA Assembly Req: N

Also Available:

6740-ET-S in Sheer Dove at \$2157

M740-ET in Custom Finishes at \$2997

Casegoods

6740-ET-S — Price: \$2157

Heatherwood End Table

Collection: LIBBY LANGDON FOR FAIRFIELD

Dimensions: 34w × 20d × 28h **Weight:** 87 / 87 lbs **Cube:** 15.26

Standard Finish: Sheer Dove **Apron Height:** N/A

Materials: Walnut Solids and Veneers

Highlight Striping: N/A

Contrasting Finishes or Paints: +\$539

Conversion Varnish: +\$450

Paint Match: +\$539

Finished in Sheer Dove with Polished Nickel accents and two, soft-close drawers. Also available in any Monogram Finish as M740-ET.

Country: CHINA **Assembly Req:** N

Also Available:

6740-ET-M in Modern Truffle at \$2157

M740-ET in Custom Finishes at \$2997

6741-17-M — Price: \$5397

Miller Master Chest

Collection: LIBBY LANGDON FOR FAIRFIELD

Dimensions: 76w × 20d × 36h **Weight:** 300 / 300 lbs **Cube:** 40.74

Standard Finish: Modern Truffle **Apron Height:** N/A

Materials: Walnut Solids & Veneers

Highlight Striping: N/A

Contrasting Finishes or Paints: +\$1349

Conversion Varnish: +\$810

Paint Match: +\$1349

Finished in Modern Truffle with Brushed Brass metal accents and nine soft-close drawers. Also available in any Monogram Finish as M741-17.

Country: CHINA **Assembly Req:** N

Also Available:

6741-17-S in Sheer Dove at \$5397

M741-17 in Custom Finishes at \$6537

6741-17-S — Price: \$5397

Miller Master Chest

Collection: LIBBY LANGDON FOR FAIRFIELD

Dimensions: 76w × 20d × 36h **Weight:** 300 / 300 lbs **Cube:** 49.6

Standard Finish: Sheer Dove **Apron Height:** N/A

Materials: Walnut Solids & Veneers

Highlight Striping: N/A

Contrasting Finishes or Paints: +\$1349

Conversion Varnish: +\$810

Paint Match: +\$1349

Finished in Sheer Dove with Brushed Brass metal accents and nine soft-close drawers. Also available in any Monogram Finish as M741-17.

Country: CHINA **Assembly Req:** N

Also Available:

6741-17-M in Modern Truffle at \$5397

M741-17 in Custom Finishes at \$6537

6741-38-M — Price: \$2997

Miller Large End Table

Collection: LIBBY LANGDON FOR FAIRFIELD

Dimensions: 40w × 22d × 32h **Weight:** 138 / 138 lbs **Cube:** 21.52

Standard Finish: Modern Truffle **Apron Height:** N/A

Materials: Walnut Solids and Veneers

Highlight Striping: N/A

Contrasting Finishes or Paints: +\$749

Conversion Varnish: +\$450

Paint Match: +\$749

Finished in Modern Truffle with Brushed Brass metal accents, one open storage shelf, and two soft-close drawers. Also available in any Monogram Finish as M741-38.

Country: CHINA **Assembly Req:** N

Also Available:

M741-38 in Custom Finishes at \$3897

6741-ET-S — Price: \$2247

Miller End Table

Collection: LIBBY LANGDON FOR FAIRFIELD

Dimensions: 28w × 22d × 28h **Weight:** 86 / 86 lbs **Cube:** 13.57

Standard Finish: Sheer Dove **Apron Height:** N/A

Materials: Walnut Solids & Veneers

Highlight Striping: N/A

Contrasting Finishes or Paints: N/A

Conversion Varnish: +\$450

Paint Match: +\$562

Finished in Sheer Dove with Brushed Brass metal accents, one open storage shelf, and two soft-close drawers.

Country: CHINA **Assembly Req:** N

6760-93 — Price: \$3387

Millstone Cocktail Table

Collection: LIBBY LANGDON FOR FAIRFIELD

Dimensions: 50w × 30d × 18.75h **Weight:** 148 / 148 lbs **Cube:** 9.8

Standard Finish: **Apron Height:** 17.75

Materials: Dark Bronze Metal & Calcutta Marble

Highlight Striping: N/A

Contrasting Finishes or Paints: N/A

Conversion Varnish: N/A

Paint Match: N/A

Metal base finished in Dark Bronze, gray and white Calcutta Marble top.

Country: CHINA **Assembly Req:** N

6760-95 — Price: \$2307

Millstone End Table

Collection: LIBBY LANGDON FOR FAIRFIELD

Dimensions: 26w × 20d × 25h **Weight:** 80 / 80 lbs **Cube:** 4.51

Standard Finish: **Apron Height:** 24

Materials: Dark Bronze Metal & Calcutta Marble

Highlight Striping: N/A

Contrasting Finishes or Paints: N/A

Conversion Varnish: N/A

Paint Match: N/A

Metal base finished in Dark Bronze, gray and white Calcutta Marble top.

Country: CHINA **Assembly Req:** N

6760-96 — Price: \$3387

Millstone Console Table

Collection: LIBBY LANGDON FOR FAIRFIELD

Dimensions: 54w × 14d × 34h **Weight:** 138 / 138 lbs **Cube:** 20.38

Standard Finish: **Apron Height:** N/A

Materials: Dark Bronze Metal & Calcutta Marble

Highlight Striping: N/A

Contrasting Finishes or Paints: N/A

Conversion Varnish: N/A

Paint Match: N/A

Metal base finished in Dark Bronze, gray and white Calcutta Marble top.

Country: CHINA **Assembly Req:** N

Casegoods

6761-96 — Price: \$1497

Herbert Console

Collection: LIBBY LANGDON FOR FAIRFIELD

Dimensions: 50w × 12d × 31h Weight: 84 / 84 lbs Cube: 10.76

Standard Finish: Dark Sable Apron Height: N/A

Materials: Walnut Solids and Veneers

Highlight Striping: N/A

Contrasting Finishes or Paints: +\$374

Conversion Varnish: +\$450

Paint Match: +\$374

Dark Sable exterior with Soft White Interior.

Country: CHINA Assembly Req: N

6762-96 — Price: \$2307

Lendell Console Table

Collection: LIBBY LANGDON FOR FAIRFIELD

Dimensions: 64w × 16d × 36h Weight: 163 / 163 lbs Cube: 27.55

Standard Finish: Dark Sable Apron Height: N/A

Materials: Quartered Ash Solids & Veneers

Highlight Striping: N/A

Contrasting Finishes or Paints: +\$577

Conversion Varnish: +\$450

Paint Match: +\$577

Finished in Dark Sable with one fixed shelf and three soft-close drawers wrapped in Glazed Tan linen. Also available in any Monogram Finish as M762-96.

Country: CHINA Assembly Req: N

Also Available:

M762-96 in Custom Finishes at \$3987

6764-81 — Price: \$2157

Lionel Console Desk

Collection: LIBBY LANGDON FOR FAIRFIELD

Dimensions: 56w × 20d × 30h Weight: 106 / 106 lbs Cube: 10.69

Standard Finish: Dark Sable Apron Height: 24

Materials: Birch Solids & Walnut Veneers

Highlight Striping: N/A

Contrasting Finishes or Paints: +\$539

Conversion Varnish: +\$450

Paint Match: +\$539

Finished in Dark Sable with Antique Brass metal accents and ferrules. Three drawers. Also available in any Monogram Finish as M764-81.

Country: CHINA Assembly Req: Y

Also Available:

M764-81 in Custom Finishes at \$3447

6765-96-2 — Price: \$3387

Jessup Console Table

Collection: LIBBY LANGDON FOR FAIRFIELD

Dimensions: 54w × 20d × 36h Weight: 135 / 135 lbs Cube: 29.25

Standard Finish: Nickel Apron Height: N/A

Materials: Stainless Steel with Carrara Marble Top

Highlight Striping: N/A

Contrasting Finishes or Paints: N/A

Conversion Varnish: N/A

Paint Match: N/A

Stainless steel base finished in Nickel and white Carrara Marble top. Sized to accommodate two 6765-07-2 Jessup Counter Stools.

Country: CHINA Assembly Req: N

6766-96 — Price: \$4197

Barker Credenza

Collection: LIBBY LANGDON FOR FAIRFIELD

Dimensions: 74w × 14d × 32h Weight: 0 / 0 lbs Cube: 19.17

Standard Finish: Champagne Apron Height: N/A

Materials: White Carrara Stone, Metal

Highlight Striping: N/A

Contrasting Finishes or Paints: N/A

Conversion Varnish: N/A

Paint Match: N/A

Features two drawers. Inset carrara marble on top and all shelves. Consists of 6766-96-T (Top) and 6766-96-B (Base)

Country: INDIA Assembly Req: Y

6780-81 — Price: \$3117

Patton Desk

Collection: LIBBY LANGDON FOR FAIRFIELD

Dimensions: 54w × 24d × 30h Weight: 148 / 148 lbs Cube: 15.61

Standard Finish: Sheer Dove Apron Height: N/A

Materials: Walnut Solids and Veneers

Highlight Striping: N/A

Contrasting Finishes or Paints: +\$779

Conversion Varnish: +\$468

Paint Match: +\$779

Sheer Dove Finish. Brass Hardware pulls. One lockable drawer and three smaller drawers. Center drawer has a drop-down lid. Also available in any Monogram Finish as M780-81.

Country: CHINA Assembly Req: N

Also Available:

M780-81 in Custom Finishes at \$4347

6800-DT — Price: \$5097

Lyncliff Dining Table

Collection: LIBBY LANGDON FOR FAIRFIELD

Dimensions: 84w × 42d × 30h Weight: 286 / 286 lbs Cube: 50.55

Standard Finish: Dark Sable Apron Height: N/A

Materials: Quartered Ash Solids & Veneers

Highlight Striping: N/A

Contrasting Finishes or Paints: +\$1274

Conversion Varnish: +\$765

Paint Match: +\$1274

Finished in Dark Sable with two, 22" removable leaves and equalizing slide mechanism. Consists of 6800-DT-B (Base) and 6800-DT-T (Top).

Country: CHINA Assembly Req: Y

6801-DT — Price: \$4137

Whitby Dining Table

Collection: LIBBY LANGDON FOR FAIRFIELD

Dimensions: 88w × 42d × 30h Weight: 165 / 165 lbs Cube: 22.01

Standard Finish: Cerused Espresso Apron Height: N/A

Materials: Alder Solids & Walnut Veneers

Highlight Striping: N/A

Contrasting Finishes or Paints: +\$1034

Conversion Varnish: +\$621

Paint Match: +\$1034

Finished in Cerused Espresso with Polished Nickel ferrules and medallions. Consists of 6801-DT-B (Base) and 6801-DT-T (Top).

Country: CHINA Assembly Req: Y

Casegoods

6803-DT — Price: \$3597

Hotchner Round Dining Table

Collection: LIBBY LANGDON FOR FAIRFIELD

Dimensions: 48w × 48d × 30.5h **Weight:** 217 / 217 lbs **Cube:** 40.66

Standard Finish: Smoked Stone **Apron Height:** N/A

Materials: Stainless Steel, Acrylic, Walnut Solids and Veneers

Highlight Striping: N/A **Contrasting Finishes or Paints:** N/A

Conversion Varnish: +\$540 **Paint Match:** +\$899

Features a 22" filler. Also available in any Monogram Finish as M803-DT.

Country: CHINA **Assembly Req:** Y

Also Available:
M803-DT in Custom Finishes at \$4647

6821-17 — Price: \$5637

Baystone Credenza

Collection: LIBBY LANGDON FOR FAIRFIELD

Dimensions: 80w × 20d × 39h **Weight:** 302 / 302 lbs **Cube:** 46.39

Standard Finish: Modern Truffle **Apron Height:** N/A

Materials: Alder Solids & Walnut Veneers

Highlight Striping: N/A **Contrasting Finishes or Paints:** +\$1409

Conversion Varnish: +\$846 **Paint Match:** +\$1409

Finished in Modern Truffle with Polished Nickel hardware and ferrules. Features five soft-close drawers, and storage areas with cord exit holes behind two doors.

Country: CHINA **Assembly Req:** N

6822-17 — Price: \$4197

Merritt Credenza

Collection: LIBBY LANGDON FOR FAIRFIELD

Dimensions: 72w × 18d × 35h **Weight:** 292 / 292 lbs **Cube:** 26.25

Standard Finish: Smoked Stone **Apron Height:** N/A

Materials: Stainless Steel, Walnut Solids and Veneers

Highlight Striping: N/A **Contrasting Finishes or Paints:** +\$1049

Conversion Varnish: +\$630 **Paint Match:** +\$1049

Features a Stainless Steel base and accents, Nickel Hardware, Four doors with one shelf behind each door. One center drawer with silver tray liner. Also available in any Monogram Finish as M822-17.

Country: CHINA **Assembly Req:** N

Also Available:
M822-17 in Custom Finishes at \$5397

6840-85 — Price: \$5697

Wesley Etageré

Collection: LIBBY LANGDON FOR FAIRFIELD

Dimensions: 36w × 14d × 90h **Weight:** 216 / 216 lbs **Cube:** 33.41

Standard Finish: Cerused Espresso **Apron Height:** N/A

Materials: Ash Solids

Highlight Striping: N/A **Contrasting Finishes or Paints:** N/A

Conversion Varnish: N/A **Paint Match:** N/A

Finished in Cerused Espresso with Brushed Brass metal accents, three glass shelves, and touch LED lighting.

Country: CHINA **Assembly Req:** N

6841-85 — Price: \$5697

Wesley Etageré

Collection: LIBBY LANGDON FOR FAIRFIELD

Dimensions: 36w × 14d × 90h **Weight:** 216 / 216 lbs **Cube:** 33.41

Standard Finish: Sheer Dove **Apron Height:** N/A

Materials: Ash Solids

Highlight Striping: N/A **Contrasting Finishes or Paints:** N/A

Conversion Varnish: N/A **Paint Match:** N/A

Finished in Sheer Dove with Brushed Brass metal accents, three glass shelves, and touch LED lighting.

Country: CHINA **Assembly Req:** N

V-6900-KB-M — Price: \$3747

Shelby King Bed

Collection: LIBBY LANGDON FOR FAIRFIELD

Dimensions: 80.75w × 88d × 66h **Weight:** 245 / 245 lbs **Cube:** 63.7

Standard Finish: Modern Truffle **Apron Height:** 6

Materials: Beech

Highlight Striping: N/A **Contrasting Finishes or Paints:** N/A

Conversion Varnish: N/A **Paint Match:** N/A

Married in 9401 Ivory fabric and finished in Modern Truffle. For special order options please order using the M900-KB style number.

Country: USA **Assembly Req:** Y

Also Available:
M900-KB in Custom Options starting at \$1479

V-6900-KB-S — Price: \$3747

Shelby King Bed

Collection: LIBBY LANGDON FOR FAIRFIELD

Dimensions: 80.75w × 88d × 66h **Weight:** 245 / 245 lbs **Cube:** 271.4

Standard Finish: Sheer Dove **Apron Height:** 6

Materials: Beech

Highlight Striping: N/A **Contrasting Finishes or Paints:** N/A

Conversion Varnish: N/A **Paint Match:** N/A

Stocked in Fabric 9401 Ivory in Sheer Dove finish. For special order options please order using the M900-KB style number.

Country: USA **Assembly Req:** Y

Also Available:
M900-KB in Custom Options starting at \$1479

V-6900-QB-M — Price: \$3627

Shelby Queen Bed

Collection: LIBBY LANGDON FOR FAIRFIELD

Dimensions: 67.75w × 88d × 66h **Weight:** 252 / 252 lbs **Cube:** 227.71

Standard Finish: Modern Truffle **Apron Height:** 6

Materials: Beech

Highlight Striping: N/A **Contrasting Finishes or Paints:** N/A

Conversion Varnish: N/A **Paint Match:** N/A

Married in 9401 Ivory fabric and finished in Modern Truffle. For special order options please order using the M900-QB style number

Country: USA **Assembly Req:** Y

Also Available:
M900-QB in Custom Options starting at \$1429

Casegoods

V-6901-KB-M — Price: \$3747

Ackerly King Bed

Collection: LIBBY LANGDON FOR FAIRFIELD

Dimensions: 81w × 84d × 66h Weight: 225 / 225 lbs Cube: 259.87

Standard Finish: Modern Truffle Apron Height: 5.5

Materials: Beech

Highlight Striping: N/A

Contrasting Finishes or Paints: N/A

Conversion Varnish: N/A

Paint Match: N/A

Stocked in Fabric 9401 Ivory in Modern Truffle finish. For special order options please order using the M901-KB style number.

Country: USA Assembly Req: Y

Also Available:

M901-KB in Custom Options starting at \$1479

V-6901-KB-S — Price: \$3747

Ackerly King Bed

Collection: LIBBY LANGDON FOR FAIRFIELD

Dimensions: 81w × 84d × 66h Weight: 225 / 225 lbs Cube: 64.63

Standard Finish: Sheer Dove Apron Height: 5.5

Materials: Beech

Highlight Striping: N/A

Contrasting Finishes or Paints: N/A

Conversion Varnish: N/A

Paint Match: N/A

Married in 9401 Ivory fabric and finished in Sheer Dove. For special order options please order using the M901-KB style number.

Country: USA Assembly Req: Y

Also Available:

M901-KB in Custom Options starting at \$1479

V-6901-QB-M — Price: \$3597

Ackerly Queen Bed

Collection: LIBBY LANGDON FOR FAIRFIELD

Dimensions: 65w × 84d × 66h Weight: 232 / 232 lbs Cube: 208.54

Standard Finish: Modern Truffle Apron Height: 5.5

Materials: Beech

Highlight Striping: N/A

Contrasting Finishes or Paints: N/A

Conversion Varnish: N/A

Paint Match: N/A

Stocked in Fabric 9401 Ivory in Modern Truffle finish. For special order options please order using the M901-QB style number.

Country: USA Assembly Req: Y

Also Available:

M901-QB in Custom Options starting at \$1429

V-6901-QB-S — Price: \$3597

Ackerly Queen Bed

Collection: LIBBY LANGDON FOR FAIRFIELD

Dimensions: 65w × 84d × 66h Weight: 232 / 232 lbs Cube: 208.54

Standard Finish: Sheer Dove Apron Height: 5.5

Materials: Beech

Highlight Striping: N/A

Contrasting Finishes or Paints: N/A

Conversion Varnish: N/A

Paint Match: N/A

Married in 9401 Ivory fabric and finished in Sheer Dove. For special order options please order using the M901-QB style number.

Country: USA Assembly Req: Y

Also Available:

M901-QB in Custom Options starting at \$1429

8000-13 — Price: \$1737

Palermo Round Cocktail Table

Collection: PALERMO

Dimensions: 36w × 36d × 19h Weight: 127 / 127 lbs Cube: 14.25

Standard Finish: Apron Height: N/A

Materials: Chiseled White Marble, Stainless Steel

Highlight Striping: N/A

Contrasting Finishes or Paints: N/A

Conversion Varnish: N/A

Paint Match: N/A

Table consists of 8000-13-T Top and 8000-13-B Base.

Country: INDIA Assembly Req: Y

8000-19 — Price: \$1107

Palermo Round End Table

Collection: PALERMO

Dimensions: 24w × 24d × 24h Weight: 65 / 65 lbs Cube: 8

Standard Finish: Apron Height: N/A

Materials: Chiseled White Marble, Stainless Steel

Highlight Striping: N/A

Contrasting Finishes or Paints: N/A

Conversion Varnish: N/A

Paint Match: N/A

Country: INDIA Assembly Req: Y

8000-88 — Price: \$687

Equestrian Tack Drink Table

Collection: SUNDRIES

Dimensions: 18w × 9d × 20h Weight: 26 / 26 lbs Cube: 1.87

Standard Finish: Apron Height: N/A

Materials: Mango Solids, Iron

Highlight Striping: N/A

Contrasting Finishes or Paints: N/A

Conversion Varnish: N/A

Paint Match: N/A

Solid Mango Log in a Blackwashed finish, Iron Base in Antique Zinc Finish.

Country: INDIA Assembly Req: N

8000-93 — Price: \$1947

Palermo Rectangular Cocktail Table

Collection: PALERMO

Dimensions: 50w × 30d × 16.5h Weight: 129 / 129 lbs Cube: 0

Standard Finish: Apron Height: N/A

Materials: Chiseled White Marble, Stainless Steel

Highlight Striping: N/A

Contrasting Finishes or Paints: N/A

Conversion Varnish: N/A

Paint Match: N/A

Table consists of 8000-93-T Top and 8000-93-B Base.

Country: INDIA Assembly Req: Y

Casegoods

8000-99 — Price: \$1737

Palermo Console Table

Collection: PALERMO

Dimensions: 60w × 14d × 30h Weight: 100 / 100 lbs Cube: 23.73

Standard Finish: Apron Height: N/A

Materials: Chiseled White Marble, Stainless Steel

Highlight Striping: N/A

Contrasting Finishes or Paints: N/A

Conversion Varnish: N/A

Paint Match: N/A

Table consists of 8000-99-T Top and 8000-99-B Base.

Country: INDIA Assembly Req: Y

8000-CS — Price: \$447

Palermo Drink Table

Collection: PALERMO

Dimensions: 12w × 12d × 22h Weight: 82 / 82 lbs Cube: 1.83

Standard Finish: Apron Height: N/A

Materials: Chiseled White Marble, Stainless Steel

Highlight Striping: N/A

Contrasting Finishes or Paints: N/A

Conversion Varnish: N/A

Paint Match: N/A

Country: INDIA Assembly Req: N

8000-DK — Price: \$2547

Palermo Desk

Collection: PALERMO

Dimensions: 60w × 30d × 30h Weight: 331 / 331 lbs Cube: 31.25

Standard Finish: Apron Height: N/A

Materials: Chiseled White Marble, Stainless Steel

Highlight Striping: N/A

Contrasting Finishes or Paints: N/A

Conversion Varnish: N/A

Paint Match: N/A

Features four metal shelves.

Country: INDIA Assembly Req: N

8000-DT — Price: \$2997

Palermo Round Dining Table

Collection: PALERMO

Dimensions: 48w × 48d × 30.5h Weight: 262 / 262 lbs Cube: 28.64

Standard Finish: Apron Height: N/A

Materials: Chiseled White Marble, Stainless Steel

Highlight Striping: N/A

Contrasting Finishes or Paints: N/A

Conversion Varnish: N/A

Paint Match: N/A

Table consists of 8000-DT-T Top and 8000-DT-B Base.

Country: INDIA Assembly Req: Y

8001-17 — Price: \$4797

Portofino Credenza

Collection: PORTOFINO

Dimensions: 72w × 21d × 38h Weight: 269 / 269 lbs Cube: 36.83

Standard Finish: Linen Apron Height: 6

Materials: White Oak Solids and Veneers

Highlight Striping: N/A

Contrasting Finishes or Paints: +\$1199

Conversion Varnish: +\$720

Paint Match: +\$1199

Linen Finish. Four Doors, Four Adjustable shelves.

Country: CHINA Assembly Req: N

8001-81 — Price: \$3387

Portofino Desk

Collection: PORTOFINO

Dimensions: 60w × 30d × 30h Weight: 133 / 133 lbs Cube: 13.55

Standard Finish: Linen Apron Height: 25.25

Materials: White Oak Solids and Veneers

Highlight Striping: N/A

Contrasting Finishes or Paints: +\$847

Conversion Varnish: +\$508

Paint Match: +\$847

Linen Finish. Two Pencil Drawers on left and right side. One Center Drawer with drop down drawer front. Cord Management. Also available in any Monogram Finish as M001-81

Country: CHINA Assembly Req: Y

Also Available:
M001-81 in Custom Finishes at \$4617

8001-84 — Price: \$3177

Portofino Lateral File

Collection: PORTOFINO

Dimensions: 47w × 22d × 33h Weight: 143 / 143 lbs Cube: 21.48

Standard Finish: Linen Apron Height: 5.75

Materials: White Oak Solids and Veneers

Highlight Striping: N/A

Contrasting Finishes or Paints: +\$794

Conversion Varnish: +\$477

Paint Match: +\$794

Linen Finish. Two Locking File drawers. Also available in any Monogram Finish as M001-84

Country: CHINA Assembly Req: N

Also Available:
M001-84 in Custom Finishes at \$4107

8001-DT — Price: \$3897

Portofino Dining Table

Collection: PORTOFINO

Dimensions: 58w × 58d × 30h Weight: 201 / 201 lbs Cube: 23.87

Standard Finish: Linen Apron Height: 25.75

Materials: White Oak Solids and Veneers

Highlight Striping: N/A

Contrasting Finishes or Paints: +\$974

Conversion Varnish: +\$585

Paint Match: +\$974

Linen Finish. Features One 22" Leaf. Extended Dimension: 80x80x30. Also available in any Monogram Finish as M001-DT.

Country: CHINA Assembly Req: Y

Also Available:
M001-DT in Custom Finishes at \$4947

Casegoods

8003-13 — Price: \$2697

Sequoia Round Cocktail Table

Collection: SEQUOIA

Dimensions: 40w × 40d × 16.5h Weight: 82 / 82 lbs Cube: 15.27

Standard Finish: Apron Height: N/A

Materials: Burl Veneer

Highlight Striping: N/A

Contrasting Finishes or Paints: N/A

Conversion Varnish: +\$450

Paint Match: N/A

Features Brushed Gold metal base.

Country: INDIA Assembly Req: N

8003-47 — Price: \$2037

Sequoia Oval End Table

Collection: SEQUOIA

Dimensions: 32w × 18d × 28h Weight: 61 / 61 lbs Cube: 15

Standard Finish: Apron Height: N/A

Materials: Burl Veneer, Metal Accents

Highlight Striping: N/A

Contrasting Finishes or Paints: N/A

Conversion Varnish: +\$450

Paint Match: N/A

Features one drawer with Brush Gold hardware pull.

Country: INDIA Assembly Req: N

8003-92 — Price: \$2397

Sequoia Square Cocktail Table

Collection: SEQUOIA

Dimensions: 40w × 40d × 16.25h Weight: 120 / 120 lbs Cube: 22.4

Standard Finish: Apron Height: N/A

Materials: Burl Veneer, Metal Accents

Highlight Striping: N/A

Contrasting Finishes or Paints: N/A

Conversion Varnish: +\$450

Paint Match: N/A

Features Brushed Gold metal ferrule on bottom of legs.

Country: INDIA Assembly Req: N

8003-99 — Price: \$2097

Sequoia Sofa Table

Collection: SEQUOIA

Dimensions: 60w × 14d × 32.5h Weight: 79 / 79 lbs Cube: 15.79

Standard Finish: Apron Height: N/A

Materials: Burl Veneer, Metal Accents

Highlight Striping: N/A

Contrasting Finishes or Paints: N/A

Conversion Varnish: +\$450

Paint Match: N/A

Features Brushed Gold metal ferrule on bottom of legs.

Country: INDIA Assembly Req: N

8003-CS — Price: \$1197

Sequoia Chairside Table

Collection: SEQUOIA

Dimensions: 22w × 18d × 25h Weight: 51 / 51 lbs Cube: 9.7

Standard Finish: Apron Height: N/A

Materials: Burl Veneer, Metal Accents

Highlight Striping: N/A

Contrasting Finishes or Paints: N/A

Conversion Varnish: +\$450

Paint Match: N/A

Features Brushed Gold metal ferrule on bottom of legs.

Country: INDIA Assembly Req: N

8003-ET — Price: \$2037

Sequoia End Table

Collection: SEQUOIA

Dimensions: 32w × 18d × 28h Weight: 71 / 71 lbs Cube: 15

Standard Finish: Apron Height: N/A

Materials: Burl Veneer, Metal Accents

Highlight Striping: N/A

Contrasting Finishes or Paints: N/A

Conversion Varnish: +\$450

Paint Match: N/A

Features one drawer with Brush Gold hardware pull.

Country: INDIA Assembly Req: N

8005-16 — Price: \$1047

Tulip Dining Height Table Base

Collection: MASSIMO, LIVE EDGE

Dimensions: 20w × 20d × 28h Weight: 79 / 79 lbs Cube: 9.79

Standard Finish: Blanca Apron Height: N/A

Materials: Metal

Highlight Striping: N/A

Contrasting Finishes or Paints: N/A

Conversion Varnish: N/A

Paint Match: N/A

Features Adjustable levelers. This style is sold as one base. When pairing with rectangular Live Edge tops, two bases are required.

Country: CHINA Assembly Req: Y

8005-26 — Price: \$897

Carrara Marble 26" Diameter Table top with Pencil Edge

Collection: MASSIMO

Dimensions: 26w × 26d × 2h Weight: 68 / 68 lbs Cube: 0.78

Standard Finish: Blanca Apron Height: N/A

Materials: White Carrara Marble

Highlight Striping: N/A

Contrasting Finishes or Paints: N/A

Conversion Varnish: N/A

Paint Match: N/A

Features a pencil edge.

Country: CHINA Assembly Req: Y

Casegoods

8005-36 — Price: \$1197

Carrara Marble 36" Round Table Top

Collection: MASSIMO

Dimensions: 36w × 36d × 2h Weight: 92 / 92 lbs Cube: 3.79

Standard Finish: Apron Height: N/A

Materials: White Carrara Marble

Highlight Striping: N/A

Contrasting Finishes or Paints: N/A

Conversion Varnish: N/A

Paint Match: N/A

Features a Pencil Edge Detail.

Country: CHINA Assembly Req: Y

8005-46 — Price: \$987

Tulip Cocktail Height Table Base

Collection: MASSIMO

Dimensions: 20.5w × 20.5d × 19h Weight: 71 / 71 lbs Cube: 4.62

Standard Finish: Blanca Apron Height: N/A

Materials: Metal

Highlight Striping: N/A

Contrasting Finishes or Paints: N/A

Conversion Varnish: N/A

Paint Match: N/A

Features Adjustable levelers. Blanca finish

Country: CHINA Assembly Req: Y

8005-48 — Price: \$2187

Carrara Marble 48" Round Table Top

Collection: MASSIMO

Dimensions: 48w × 48d × 2h Weight: 154 / 154 lbs Cube: 6.38

Standard Finish: Apron Height: N/A

Materials: White Carrara Marble

Highlight Striping: N/A

Contrasting Finishes or Paints: N/A

Conversion Varnish: N/A

Paint Match: N/A

Features a Pencil Edge Detail.

Country: CHINA Assembly Req: Y

8005-54 — Price: \$1497

Carrara Marble 54" Oval Table Top

Collection: MASSIMO

Dimensions: 54w × 28d × 2h Weight: 99 / 99 lbs Cube: 4.43

Standard Finish: Apron Height: N/A

Materials: White Carrara Marble

Highlight Striping: N/A

Contrasting Finishes or Paints: N/A

Conversion Varnish: N/A

Paint Match: N/A

Features a Pencil Edge Detail.

Country: CHINA Assembly Req: Y

8005-BT — Price: \$987

Tulip Bar Height Table Base

Collection: MASSIMO

Dimensions: 20w × 20d × 39h Weight: 62 / 62 lbs Cube: 9.02

Standard Finish: Blanca Apron Height: N/A

Materials: Metal

Highlight Striping: N/A

Contrasting Finishes or Paints: N/A

Conversion Varnish: N/A

Paint Match: N/A

Country: CHINA Assembly Req: Y

8005-CB — Price: \$987

Tulip Counter Height Table Base

Collection: MASSIMO

Dimensions: 20w × 20d × 35h Weight: 55 / 55 lbs Cube: 8.1

Standard Finish: Blanca Apron Height: N/A

Materials: Metal

Highlight Striping: N/A

Contrasting Finishes or Paints: N/A

Conversion Varnish: N/A

Paint Match: N/A

Country: CHINA Assembly Req: Y

8006-16 — Price: \$1047

Tulip Dining Height Table Base

Collection: MASSIMO, LIVE EDGE

Dimensions: 20w × 20d × 28h Weight: 79 / 79 lbs Cube: 9.79

Standard Finish: Black Apron Height: N/A

Materials: Metal

Highlight Striping: N/A

Contrasting Finishes or Paints: N/A

Conversion Varnish: N/A

Paint Match: N/A

Features Adjustable levelers. This style is sold as one base. When pairing with rectangular Live Edge tops, two bases are required.

Country: CHINA Assembly Req: Y

8006-46 — Price: \$987

Tulip Cocktail Height Table Base

Collection: MASSIMO

Dimensions: 20.5w × 20.5d × 19h Weight: 71 / 71 lbs Cube: 4.62

Standard Finish: Black Apron Height: N/A

Materials: Metal

Highlight Striping: N/A

Contrasting Finishes or Paints: N/A

Conversion Varnish: N/A

Paint Match: N/A

Features Adjustable levelers. Oro finish

Country: CHINA Assembly Req: Y

Casegoods

8006-BT — Price: \$987

Tulip Bar Height Table Base

Collection: MASSIMO

Dimensions: 20w × 20d × 39h Weight: 62 / 62 lbs Cube: 9.02

Standard Finish: Black Apron Height: N/A

Materials: Metal

Highlight Striping: N/A

Contrasting Finishes or Paints: N/A

Conversion Varnish: N/A

Paint Match: N/A

Country: CHINA Assembly Req: Y

8006-CB — Price: \$987

Tulip Counter Height Table Base

Collection: MASSIMO

Dimensions: 20w × 20d × 35h Weight: 55 / 55 lbs Cube: 8.1

Standard Finish: Black Apron Height: N/A

Materials: Metal

Highlight Striping: N/A

Contrasting Finishes or Paints: N/A

Conversion Varnish: N/A

Paint Match: N/A

Country: CHINA Assembly Req: Y

8007-86-2 — Price: \$1197

Beverly Activity Table

Collection:

Dimensions: 38w × 38d × 30h Weight: 57 / 57 lbs Cube: 25.06

Standard Finish: Nickel Apron Height: N/A

Materials:

Highlight Striping: N/A

Contrasting Finishes or Paints: N/A

Conversion Varnish: N/A

Paint Match: N/A

Upholstered in faux-leather 3109 Flax. 1,500,000 Double Rubs. W Cleaning Code- water based cleaner.

Country: CHINA Assembly Req: Y

Also Available:

8007-86-6 in Brushed Brass at \$1197

8007-86-6 — Price: \$1197

Beverly Activity Table

Collection:

Dimensions: 38w × 38d × 30h Weight: 57 / 57 lbs Cube: 25.06

Standard Finish: Brushed Brass Apron Height: N/A

Materials:

Highlight Striping: N/A

Contrasting Finishes or Paints: N/A

Conversion Varnish: N/A

Paint Match: N/A

Upholstered in faux-leather 3109 Flax. 1,500,000 Double Rubs. W Cleaning Code- water based cleaner.

Country: CHINA Assembly Req: Y

Also Available:

8007-86-2 in Nickel at \$1197

8007-96-2 — Price: \$1137

Beverly Console Table

Collection:

Dimensions: 60w × 18d × 34h Weight: 47 / 47 lbs Cube: 21.25

Standard Finish: Nickel Apron Height: 31

Materials: Rubberwood Solids

Highlight Striping: N/A

Contrasting Finishes or Paints: N/A

Conversion Varnish: N/A

Paint Match: N/A

Upholstered in faux-leather 3109 Flax with Nickel nailhead trim and ferrules. 1,500,000 Double Rubs. W Cleaning Code- water based cleaner.

Country: CHINA Assembly Req: Y

Also Available:

8007-96-6 in Brushed Brass at \$1137

8007-96-6 — Price: \$1137

Beverly Console Table

Collection:

Dimensions: 60w × 18d × 34h Weight: 47 / 47 lbs Cube: 21.25

Standard Finish: Brushed Brass Apron Height: 31

Materials: Rubberwood Solids

Highlight Striping: N/A

Contrasting Finishes or Paints: N/A

Conversion Varnish: N/A

Paint Match: N/A

Upholstered in faux-leather 3109 Flax with Brushed Brass nailhead trim and ferrules 1,500,000 Double Rubs. W Cleaning Code- water based cleaner.

Country: CHINA Assembly Req: Y

Also Available:

8007-96-2 in Nickel at \$1137

8007-99-2 — Price: \$1197

Beverly Console Table

Collection:

Dimensions: 73w × 18d × 34h Weight: 53 / 53 lbs Cube: 25.85

Standard Finish: Nickel Apron Height: 31

Materials: Rubberwood Solids

Highlight Striping: N/A

Contrasting Finishes or Paints: N/A

Conversion Varnish: N/A

Paint Match: N/A

Upholstered in faux-leather 3109 Flax with Nickel nailhead trim and ferrules. 1,500,000 Double Rubs. W Cleaning Code- water based cleaner.

Country: CHINA Assembly Req: Y

Also Available:

8007-99-6 in Brushed Brass at \$1197

8007-99-6 — Price: \$1197

Beverly Console Table

Collection:

Dimensions: 73w × 18d × 34h Weight: 53 / 53 lbs Cube: 25.85

Standard Finish: Brushed Brass Apron Height: 31

Materials: Rubberwood Solids

Highlight Striping: N/A

Contrasting Finishes or Paints: N/A

Conversion Varnish: N/A

Paint Match: N/A

Upholstered in faux-leather 3109 Flax with Brushed Brass nailhead trim and ferrules 1,500,000 Double Rubs. W Cleaning Code- water based cleaner.

Country: CHINA Assembly Req: Y

Also Available:

8007-99-2 in Nickel at \$1197

Casegoods

8009-86 — Price: \$1947

Oscar Activity Table

Collection:

Dimensions: 38w × 38d × 30h Weight: 53 / 53 lbs Cube: 25.06

Standard Finish: Hazelnut Apron Height: N/A

Materials: Walnut Solids and Veneers

Highlight Striping: N/A

Contrasting Finishes or Paints: N/A

Conversion Varnish: +\$450

Paint Match: +\$487

Features a lift off top with the reverse side to be used as a chess board. Beneath the lift off top, an inset backgammon board is available. Pull out drink holders are on each side of the table.

Country: CHINA Assembly Req: Y

8011-88 — Price: \$807

Lindsay Drink Table

Collection:

Dimensions: 14w × 14d × 26h Weight: 27 / 27 lbs Cube: 3.52

Standard Finish: Gold Apron Height: N/A

Materials: Metal Frame, Acrylic

Highlight Striping: N/A

Contrasting Finishes or Paints: N/A

Conversion Varnish: N/A

Paint Match: N/A

Metal base in a gold finish and an acrylic top.

Country: CHINA Assembly Req: N

8016-13 — Price: \$2697

Ashbury Round Cocktail Table

Collection:

Dimensions: 52w × 52d × 19h Weight: 216 / 216 lbs Cube: 29.73

Standard Finish: Apron Height: N/A

Materials: Mango Solids, White Carrara Marble

Highlight Striping: N/A

Contrasting Finishes or Paints: +\$674

Conversion Varnish: N/A

Paint Match: +\$674

Features an inset white carrara stone top

Country: INDIA Assembly Req: N

8016-46 — Price: \$2397

Ashbury Oval Cocktail Table

Collection:

Dimensions: 52w × 34d × 19h Weight: 148 / 148 lbs Cube: 19.43

Standard Finish: Apron Height: N/A

Materials: Mango Solids, White Carrara Marble

Highlight Striping: N/A

Contrasting Finishes or Paints: +\$599

Conversion Varnish: N/A

Paint Match: +\$599

Features an inset white carrara stone top

Country: INDIA Assembly Req: N

8016-CH — Price: \$2097

Ashbury Chest

Collection:

Dimensions: 50w × 19d × 38h Weight: 137 / 137 lbs Cube: 20.89

Standard Finish: Apron Height: N/A

Materials: Mango Solids

Highlight Striping: N/A

Contrasting Finishes or Paints: +\$524

Conversion Varnish: +\$450

Paint Match: +\$524

Features two adjustable shelves behind each door, vented back panel and black satin door hardware

Country: INDIA Assembly Req: N

8017-18 — Price: \$5247

Everett Curio Cabinet

Collection:

Dimensions: 54w × 19d × 90h Weight: 365 / 365 lbs Cube: 53.43

Standard Finish: Biscotti Apron Height: N/A

Materials: Red Oak

Highlight Striping: N/A

Contrasting Finishes or Paints: +\$1312

Conversion Varnish: +\$787

Paint Match: +\$1312

Married Finishes: Exterior in Biscotti, Interior in Mica. Features Two glass doors and end panels. Two adjustable glass shelves. Also available in any Monogram Finish M017-18

Country: CHINA Assembly Req: N

Also Available:

M017-18 in Custom Finishes at \$6837

8017-82 — Price: \$2997

Everett Credenza

Collection:

Dimensions: 82w × 21d × 38h Weight: 291 / 291 lbs Cube: 37.86

Standard Finish: Biscotti Apron Height: N/A

Materials: Red Oak

Highlight Striping: N/A

Contrasting Finishes or Paints: +\$749

Conversion Varnish: +\$450

Paint Match: +\$749

Married Finishes: Exterior in Biscotti, Interior in Mica. Features Four doors with glass inset and wood trim. One stationary shelf behind each door. Also available in any Monogram Finish M017-82

Country: CHINA Assembly Req: N

Also Available:

M017-82 in Custom Finishes at \$3597

8017-DT — Price: \$3297

Everett Dining Table

Collection:

Dimensions: 60w × 60d × 30h Weight: 199 / 199 lbs Cube: 62.49

Standard Finish: Biscotti Apron Height: 27.5

Materials: Red Oak

Highlight Striping: N/A

Contrasting Finishes or Paints: +\$824

Conversion Varnish: +\$495

Paint Match: +\$824

Top in Biscotti Finish and Base in Mica. Also available in any Monogram Finish M017-DT-T

Country: CHINA Assembly Req: Y

Also Available:

M017-DT in Custom Finishes at \$4797

Casegoods

8018-17 — Price: \$2997

Camille Master Chest

Collection: CAMILLE

Dimensions: 72w × 20d × 34h Weight: 205 / 205 lbs Cube: 28.33

Standard Finish: Linen Apron Height: N/A

Materials: Walnut Solids and Veneers

Highlight Striping: +\$450

Contrasting Finishes or Paints: +\$749

Conversion Varnish: +\$450

Paint Match: +\$749

Features Four full extension, soft close English dovetail drawers. Linen Finish with Antique Pewter striping and Pewter drawer pulls. Also available in any Fairfield Finish as M018-17.

Country: VIETNAM Assembly Req: N

Also Available:

M018-17 in Custom Finishes at \$4107

8018-38 — Price: \$1947

Camille Chest

Collection: CAMILLE

Dimensions: 44w × 18d × 34h Weight: 140 / 140 lbs Cube: 15.58

Standard Finish: Linen Apron Height: N/A

Materials: Walnut Solids and Veneers

Highlight Striping: +\$450

Contrasting Finishes or Paints: +\$487

Conversion Varnish: +\$450

Paint Match: +\$487

Features Two full extension, soft close English dovetail drawers. Linen Finish with Antique Pewter striping and Pewter drawer pulls. Also available in any Fairfield Finish as M018-38.

Country: VIETNAM Assembly Req: N

Also Available:

M018-38 in Custom Finishes at \$2697

8018-95 — Price: \$1497

Camille Nightstand

Collection: CAMILLE

Dimensions: 32w × 20d × 30h Weight: 79 / 79 lbs Cube: 11.11

Standard Finish: Linen Apron Height: N/A

Materials: Walnut Solids and Veneers

Highlight Striping: +\$450

Contrasting Finishes or Paints: +\$374

Conversion Varnish: +\$450

Paint Match: +\$374

Features One full extension, soft close English dovetail drawers and open storage area. Linen Finish with Antique Pewter striping and Pewter drawer pulls. Also available in any Fairfield Finish as M018-95.

Country: VIETNAM Assembly Req: N

Also Available:

M018-95 in Custom Finishes at \$2247

8018-KB-L — Price: \$3747

Camille King Bed

Collection: CAMILLE

Dimensions: 80w × 84d × 60h Weight: 278 / 278 lbs Cube: 233.33

Standard Finish: Linen Apron Height: N/A

Materials: Walnut Solids and Veneers

Highlight Striping: N/A

Contrasting Finishes or Paints: N/A

Conversion Varnish: N/A

Paint Match: N/A

Married in 3712 Limestone fabric (Grade M Fairshield + Performance 80,000 Double Rubs). Linen Finish with Antique Pewter striping. Custom options are not available. Also available in any Fairfield Finish and Fabric as M018-KB

Country: VIETNAM Assembly Req: Y

Also Available:

M018-KB in Custom Options starting at \$4947

8018-QB-L — Price: \$3597

Camille Queen Bed

Collection: CAMILLE

Dimensions: 64w × 84d × 60h Weight: 261 / 261 lbs Cube: 186.66

Standard Finish: Linen Apron Height: N/A

Materials: Walnut Solids and Veneers

Highlight Striping: N/A

Contrasting Finishes or Paints: N/A

Conversion Varnish: N/A

Paint Match: N/A

Married in 3712 Limestone fabric (Grade M Fairshield + Performance 80,000 Double Rubs). Linen Finish with Antique Pewter striping. Custom options are not available. Also available in any Fairfield Finish and Fabric as M018-QB

Country: VIETNAM Assembly Req: Y

Also Available:

M018-QB in Custom Options starting at \$4797

8019-17 — Price: \$2997

Camille Master Chest

Collection: CAMILLE

Dimensions: 72w × 20d × 34h Weight: 205 / 205 lbs Cube: 28.33

Standard Finish: Linen Apron Height: N/A

Materials: Walnut Solids and Veneers

Highlight Striping: +\$450

Contrasting Finishes or Paints: +\$749

Conversion Varnish: +\$450

Paint Match: +\$749

Features Four full extension, soft close English dovetail drawers. Linen Finish with Antique Gold striping and drawer pulls.

Country: VIETNAM Assembly Req: N

Also Available:

M018-17 in Custom Finishes at \$4107

8019-38 — Price: \$1947

Camille Chest

Collection: CAMILLE

Dimensions: 44w × 18d × 34h Weight: 140 / 140 lbs Cube: 15.58

Standard Finish: Linen Apron Height: N/A

Materials: Walnut Solids and Veneers

Highlight Striping: +\$450

Contrasting Finishes or Paints: +\$487

Conversion Varnish: +\$450

Paint Match: +\$487

Features Two full extension, soft close English dovetail drawers. Linen Finish with Antique Gold striping and drawer pulls.

Country: VIETNAM Assembly Req: N

Also Available:

M018-38 in Custom Finishes at \$2697

8019-95 — Price: \$1497

Camille Nightstand

Collection: CAMILLE

Dimensions: 32w × 20d × 30h Weight: 79 / 79 lbs Cube: 11.11

Standard Finish: Linen Apron Height: N/A

Materials: Walnut Solids and Veneers

Highlight Striping: +\$450

Contrasting Finishes or Paints: +\$374

Conversion Varnish: +\$450

Paint Match: +\$374

Features One full extension, soft close English dovetail drawers and open storage area. Linen Finish with Antique Gold striping and Antique Gold drawer pulls.

Country: VIETNAM Assembly Req: N

Also Available:

M018-95 in Custom Finishes at \$2247

Casegoods

8019-KB-E — Price: \$3747

Camille King Bed

Collection: CAMILLE

Dimensions: 80w × 84d × 60h Weight: 278 / 278 lbs Cube: 233.33

Standard Finish: Linen Apron Height: N/A

Materials: Walnut Solids and Veneers

Highlight Striping: N/A

Contrasting Finishes or Paints: N/A

Conversion Varnish: N/A

Paint Match: N/A

Married in 3343 Ecru Fabric, Linen Finish with Antique Gold striping. Custom options are not available.

Country: VIETNAM Assembly Req: Y

Also Available:

M018-KB in Custom Options starting at \$4947

8019-QB-E — Price: \$3597

Camille Queen Bed

Collection: CAMILLE

Dimensions: 64w × 84d × 60h Weight: 261 / 261 lbs Cube: 186.66

Standard Finish: Linen Apron Height: N/A

Materials: Walnut Solids and Veneers

Highlight Striping: N/A

Contrasting Finishes or Paints: N/A

Conversion Varnish: N/A

Paint Match: N/A

Married in 3343 Ecru Fabric, Linen Finish with Antique Gold striping. Custom options are not available.

Country: VIETNAM Assembly Req: Y

Also Available:

M018-QB in Custom Options starting at \$4797

8020-19 — Price: \$1047

Rivers Drink Table

Collection: SUNDRIES

Dimensions: 11w × 11d × 24h Weight: 62 / 62 lbs Cube: 1.68

Standard Finish: Apron Height: N/A

Materials: Aluminum, Marble

Highlight Striping: N/A

Contrasting Finishes or Paints: N/A

Conversion Varnish: N/A

Paint Match: N/A

Bronze Finish with warm grey stone.

Country: INDIA Assembly Req: N

8021-19 — Price: \$1347

Rivers Drink Table

Collection: SUNDRIES

Dimensions: 15w × 15d × 20h Weight: 81 / 81 lbs Cube: 2.6

Standard Finish: Apron Height: N/A

Materials: Aluminum, Marble

Highlight Striping: N/A

Contrasting Finishes or Paints: N/A

Conversion Varnish: N/A

Paint Match: N/A

Bronze Finish with warm grey stone.

Country: INDIA Assembly Req: N

8022-88 — Price: \$297

Eden Drink Table

Collection: SUNDRIES

Dimensions: 10w × 10d × 25h Weight: 10 / 10 lbs Cube: 1.44

Standard Finish: Apron Height: N/A

Materials: Mango Solids

Highlight Striping: N/A

Contrasting Finishes or Paints: N/A

Conversion Varnish: N/A

Paint Match: N/A

Sandblasted Black Finish.

Country: INDIA Assembly Req: N

8023-88 — Price: \$387

Fleur Drink Table

Collection: SUNDRIES

Dimensions: 10w × 10d × 24h Weight: 55 / 55 lbs Cube: 1.38

Standard Finish: Apron Height: N/A

Materials: Aluminum, Marble

Highlight Striping: N/A

Contrasting Finishes or Paints: N/A

Conversion Varnish: N/A

Paint Match: N/A

Drink Table in Rustic Black finish, warm grey marble base and top

Country: INDIA Assembly Req: N

8024-19 — Price: \$1497

Alchemy End Table

Collection:

Dimensions: 23w × 23d × 23h Weight: 91 / 91 lbs Cube: 7.04

Standard Finish: Biscotti Apron Height: N/A

Materials: Red Oak Solids and Veneers, Marble

Highlight Striping: N/A

Contrasting Finishes or Paints: N/A

Conversion Varnish: N/A

Paint Match: N/A

Crystal Wood grain marble top with polished egde. Rope wrapped legs and an oak shelf

Country: CHINA Assembly Req: Y

8024-99 — Price: \$2547

Alchemy Console

Collection:

Dimensions: 64w × 16d × 34h Weight: 144 / 144 lbs Cube: 20.14

Standard Finish: Biscotti Apron Height: N/A

Materials: Red Oak Solids and Veneers, Marble

Highlight Striping: N/A

Contrasting Finishes or Paints: N/A

Conversion Varnish: N/A

Paint Match: N/A

Crystal Wood grain marble top with polished egde. Rope wrapped legs and an oak shelf

Country: CHINA Assembly Req: Y

Casegoods

8024-RC — Price: \$2787

Alchemy Cocktail Table

Collection:

Dimensions: 58w × 28d × 18h Weight: 150 / 150 lbs Cube: 16.91

Standard Finish: Biscotti Apron Height: N/A

Materials: Red Oak Solids and Veneers

Highlight Striping: N/A

Contrasting Finishes or Paints: N/A

Conversion Varnish: N/A

Paint Match: N/A

Crystal Wood grain marble top with polished edge. Rope wrapped legs and an oak shelf

Country: CHINA Assembly Req: Y

8025-88 — Price: \$537

Fawn Drink Table

Collection: SUNDRIES

Dimensions: 15w × 15d × 25h Weight: 11 / 11 lbs Cube: 3.25

Standard Finish: Apron Height: N/A

Materials: Mango Solids

Highlight Striping: N/A

Contrasting Finishes or Paints: N/A

Conversion Varnish: +\$450

Paint Match: N/A

Sandblasted Black Finish

Country: INDIA Assembly Req: N

8026-19 — Price: \$1347

Harper Round End Table

Collection:

Dimensions: 20w × 20d × 20h Weight: 130 / 130 lbs Cube: 4.62

Standard Finish: Apron Height: N/A

Materials: Leather, Metal Accents

Highlight Striping: N/A

Contrasting Finishes or Paints: N/A

Conversion Varnish: +\$450

Paint Match: N/A

Leather wrapped with stainless steel plinth metal base. Base and drawer pulls are in a Brass Finish. Adjustable levelers. Three soft closed felt lined drawers

Country: INDIA Assembly Req: N

8026-99 — Price: \$2397

Harper Console Table

Collection:

Dimensions: 46.5w × 16.5d × 30.5h Weight: 160 / 160 lbs Cube: 13.54

Standard Finish: Apron Height: N/A

Materials: Leather, Metal Accents, Marble

Highlight Striping: N/A

Contrasting Finishes or Paints: N/A

Conversion Varnish: +\$450

Paint Match: N/A

Leather wrapped stainless steel metal base. Drawer pulls and base are in a Brass Finish. White Carrara Marble Top. Two soft close, felt lined drawers and adjustable levelers.

Country: INDIA Assembly Req: N

8026-CH — Price: \$2547

Harper Chest

Collection:

Dimensions: 39w × 18d × 34h Weight: 150 / 150 lbs Cube: 13.81

Standard Finish: Apron Height: N/A

Materials: Leather, Metal Accents, Acrylic

Highlight Striping: N/A

Contrasting Finishes or Paints: N/A

Conversion Varnish: +\$450

Paint Match: N/A

Leather wrapped with stainless steel plinth metal base. Drawer pulls are acrylic with brass finish accents. Three soft close, felt lined drawers Adjustable levelers.

Country: INDIA Assembly Req: N

8026-ET — Price: \$1347

Harper Round End Table

Collection:

Dimensions: 18.25w × 18.25d × 21h Weight: 90 / 90 lbs Cube: 4.04

Standard Finish: Apron Height: N/A

Materials: Leather, Metal Accents, Marble

Highlight Striping: N/A

Contrasting Finishes or Paints: N/A

Conversion Varnish: +\$450

Paint Match: N/A

Leather wrapped with stainless steel metal base in Brass Finish. White Carrara Marble Top. Adjustable levelers.

Country: INDIA Assembly Req: N

8029-CH — Price: \$2547

Orion Chest

Collection:

Dimensions: 35w × 18d × 30h Weight: 150 / 150 lbs Cube: 10.93

Standard Finish: Apron Height: N/A

Materials: Leather, Metal Accents, Acrylic

Highlight Striping: N/A

Contrasting Finishes or Paints: N/A

Conversion Varnish: +\$450

Paint Match: N/A

Ivory Leather wrapped exterior with stainless steel metal base. Drawer pulls in acrylic and brass finish accents. Three Drawers. Adjustable levelers.

Country: INDIA Assembly Req: N

8030-17 — Price: \$3597

Everett Credenza

Collection:

Dimensions: 72w × 18d × 34h Weight: 342 / 342 lbs Cube: 25.5

Standard Finish: Biscotti Apron Height: N/A

Materials: Red Oak, Marble

Highlight Striping: N/A

Contrasting Finishes or Paints: +\$899

Conversion Varnish: +\$450

Paint Match: +\$899

Features four doors with stationary shelves on left and right side, adjustable shelves behind center doors. Brushed brass hardware and ferrules and inset White Carrara stone top. Also available in any Fairfield Finish as M030-17.

Country: CHINA Assembly Req: N

Also Available:

M030-17 in Custom Finishes at \$4587

Casegoods

8031-88 — Price: \$687

Cosmotini Drink Table

Collection: SUNDRIES

Dimensions: 20w × 20d × 22h Weight: 38 / 38 lbs Cube: 5.27

Standard Finish: Apron Height: N/A

Materials: Carrara Marble and Metal

Highlight Striping: N/A

Contrasting Finishes or Paints: N/A

Conversion Varnish: N/A

Paint Match: N/A

Country: INDIA Assembly Req: Y

8033-88 — Price: \$387

French 75 Drink Table

Collection: SUNDRIES

Dimensions: 12w × 12d × 24h Weight: 12 / 12 lbs Cube: 2

Standard Finish: Apron Height: N/A

Materials: Metal and Antique Glass

Highlight Striping: N/A

Contrasting Finishes or Paints: N/A

Conversion Varnish: N/A

Paint Match: N/A

Country: INDIA Assembly Req: Y

8036-28 — Price: \$687

Ashbury Drink Table

Collection:

Dimensions: 16w × 16d × 18h Weight: 26 / 26 lbs Cube: 2.66

Standard Finish: Apron Height: N/A

Materials: Mango Solids

Highlight Striping: N/A

Contrasting Finishes or Paints: N/A

Conversion Varnish: +\$450

Paint Match: +\$172

Country: INDIA Assembly Req: N

8037-95 — Price: \$687

Kendrick End Table

Collection:

Dimensions: 20w × 26d × 25h Weight: 16 / 16 lbs Cube: 7.52

Standard Finish: Modern Truffle Apron Height: N/A

Materials: Red Oak Solids and Veneers

Highlight Striping: N/A

Contrasting Finishes or Paints: N/A

Conversion Varnish: +\$450

Paint Match: +\$172

Also available in any Monogram Finish as M037-95

Country: CHINA Assembly Req: N

Also Available:

M037-95 in Custom Finishes at \$1407

8037-CK — Price: \$1137

Kendrick Cocktail Table

Collection:

Dimensions: 48w × 26d × 18h Weight: 58 / 58 lbs Cube: 13

Standard Finish: Modern Truffle Apron Height: N/A

Materials: Red Oak Solids and Veneers

Highlight Striping: N/A

Contrasting Finishes or Paints: N/A

Conversion Varnish: +\$450

Paint Match: +\$284

Also available in any Monogram Finish as M037-CK

Country: CHINA Assembly Req: N

Also Available:

M037-CK in Custom Finishes at \$2007

8037-CS — Price: \$747

Kendrick Lamp Table

Collection:

Dimensions: 26w × 26d × 25h Weight: 20 / 20 lbs Cube: 9.78

Standard Finish: Modern Truffle Apron Height: N/A

Materials: Red Oak Solids and Veneers

Highlight Striping: N/A

Contrasting Finishes or Paints: N/A

Conversion Varnish: +\$450

Paint Match: +\$187

Also available in any Monogram Finish as M037-CS

Country: CHINA Assembly Req: N

Also Available:

M037-CS in Custom Finishes at \$1467

8037-HT — Price: \$1197

Kendrick Console Table

Collection:

Dimensions: 56w × 13.5d × 34h Weight: 30 / 30 lbs Cube: 14.87

Standard Finish: Modern Truffle Apron Height: N/A

Materials: Red Oak Solids and Veneers

Highlight Striping: N/A

Contrasting Finishes or Paints: N/A

Conversion Varnish: +\$450

Paint Match: +\$299

Also available in any Monogram Finish as M037-HT

Country: CHINA Assembly Req: N

Also Available:

M037-HT in Custom Finishes at \$2097

8051-17 — Price: \$2697

Juniper Credenza

Collection:

Dimensions: 74w × 18d × 34h Weight: 225 / 225 lbs Cube: 26.2

Standard Finish: Apron Height: N/A

Materials: Mango Solids

Highlight Striping: N/A

Contrasting Finishes or Paints: N/A

Conversion Varnish: +\$450

Paint Match: N/A

Four doors with one adjustable shelf behind each door. Vented back panel

Country: INDIA Assembly Req: N

Casegoods

8052-MC — Price: \$3837

Sundries Palm Leaf Credenza

Collection: SUNDRIES

Dimensions: 79w × 19d × 30h Weight: 195 / 195 lbs Cube: 31.47

Standard Finish: Apron Height: N/A

Materials: Mango Solids, Solid Iron

Highlight Striping: N/A

Contrasting Finishes or Paints: +\$959

Conversion Varnish: +\$576

Paint Match: +\$959

Features three storage areas with a shelf, USB ports, standard outlets, and cord exit holes.

Country: INDIA Assembly Req: N

8053-MC — Price: \$3447

Sundries Naturele' Credenza

Collection: SUNDRIES

Dimensions: 70w × 18d × 34h Weight: 243 / 243 lbs Cube: 30.88

Standard Finish: Apron Height: N/A

Materials: Acacia Solids, Solid Iron

Highlight Striping: N/A

Contrasting Finishes or Paints: +\$862

Conversion Varnish: +\$517

Paint Match: +\$862

Features three storage areas with a shelf, USB ports, standard outlets, and cord exit holes.

Country: INDIA Assembly Req: N

8054-MC — Price: \$3147

Sundries Desert Storm Credenza

Collection: SUNDRIES

Dimensions: 60w × 16d × 30h Weight: 195 / 195 lbs Cube: 20.7

Standard Finish: Apron Height: N/A

Materials: Acacia Solids & Sandstone Veneers, Solid Iron

Highlight Striping: N/A

Contrasting Finishes or Paints: N/A

Conversion Varnish: +\$472

Paint Match: +\$787

Features three storage areas with a shelf, USB ports, standard outlets, and cord exit holes.

Country: INDIA Assembly Req: N

8063-17 — Price: \$2247

Arcadian Huntboard Console Table

Collection: ARCADIAN

Dimensions: 72w × 18d × 36h Weight: 96 / 96 lbs Cube: 10.73

Standard Finish: Burnished Oak Apron Height: N/A

Materials: White Oak Solids & Veneers

Highlight Striping: N/A

Contrasting Finishes or Paints: +\$562

Conversion Varnish: +\$450

Paint Match: +\$562

Features two pull-out drawers and turned wooden legs. Finished in Burnished Oak.

Country: CHINA Assembly Req: Y

8063-19 — Price: \$1077

Arcadian C-Ring End Table

Collection: ARCADIAN

Dimensions: 26w × 26d × 24h Weight: 32 / 32 lbs Cube: 11.7

Standard Finish: Burnished Oak Apron Height: N/A

Materials: White Oak Solids & Veneers

Highlight Striping: N/A

Contrasting Finishes or Paints: N/A

Conversion Varnish: +\$450

Paint Match: +\$269

Features a C-ring metal base finished in black with a round wood top finished in Burnished Oak.

Country: CHINA Assembly Req: N

8063-43 — Price: \$5997

Arcadian Dining Table

Collection: ARCADIAN

Dimensions: 84w × 42d × 30.75h Weight: 287 / 287 lbs Cube: 25.86

Standard Finish: Burnished Oak Apron Height: N/A

Materials: White Oak Solids & Veneers

Highlight Striping: N/A

Contrasting Finishes or Paints: +\$1499

Conversion Varnish: +\$900

Paint Match: +\$1499

Finished in Burnished Oak. Features one 22" leaf. Width with 22" leaf is 106" and without leaf is 84".

Country: CHINA Assembly Req: N

8063-48 — Price: \$1137

Arcadian 48" Round Dining Table Top

Collection: ARCADIAN

Dimensions: 48w × 48d × 2.5h Weight: 78 / 78 lbs Cube: 6.64

Standard Finish: Burnished Oak Apron Height: N/A

Materials: White Oak Solids & Veneers

Highlight Striping: N/A

Contrasting Finishes or Paints: N/A

Conversion Varnish: +\$450

Paint Match: +\$284

Distressed 48" Round Dining Table Top finished in Burnished Oak. Pairs with 8063-TB Arcadian Single Pedestal Table Base.

Country: CHINA Assembly Req: Y

8063-60 — Price: \$1887

Arcadian 60" Round Dining Table Top

Collection: ARCADIAN

Dimensions: 60w × 60d × 2.5h Weight: 97 / 97 lbs Cube: 10.17

Standard Finish: Burnished Oak Apron Height: N/A

Materials: White Oak Solids & Veneers

Highlight Striping: N/A

Contrasting Finishes or Paints: N/A

Conversion Varnish: +\$450

Paint Match: +\$472

Distressed 60" Round Dining Table Top finished in Burnished Oak. Pairs with 8063-TB Arcadian Single Pedestal Table Base.

Country: CHINA Assembly Req: Y

Casegoods

8063-81 — Price: \$2097

Arcadian Writing Desk

Collection: ARCADIAN

Dimensions: 60w × 29.75d × 30h Weight: 154 / 154 lbs Cube: 10.33

Standard Finish: Burnished Oak Apron Height: N/A

Materials: White Oak Solids & Veneers

Highlight Striping: N/A

Contrasting Finishes or Paints: +\$524

Conversion Varnish: +\$450

Paint Match: +\$524

Finished in Burnished Oak with black metal accents and one drawer with a pencil tray.

Country: CHINA Assembly Req: Y

8063-82 — Price: \$4257

Arcadian Sliding Glass Door Credenza

Collection: ARCADIAN

Dimensions: 78.5w × 19d × 36h Weight: 154 / 154 lbs Cube: 39.76

Standard Finish: Burnished Oak Apron Height: N/A

Materials: White Oak Solids & Veneers

Highlight Striping: N/A

Contrasting Finishes or Paints: +\$1064

Conversion Varnish: +\$639

Paint Match: +\$1064

Finished in Burnished Oak with a contrasting white interior. Two storage areas behind sliding glass doors with adjustable shelves feature adjustable LED lighting for ambiance. Pairs with 8063-83 Arcadian Sliding Glass Door Deck.

Country: CHINA Assembly Req: N

8063-83 — Price: \$4287

Arcadian Sliding Glass Door Deck

Collection: ARCADIAN

Dimensions: 71.5w × 16d × 46h Weight: 216 / 216 lbs Cube: 39.2

Standard Finish: Burnished Oak Apron Height: N/A

Materials: White Oak Solids & Veneers

Highlight Striping: N/A

Contrasting Finishes or Paints: +\$1072

Conversion Varnish: +\$643

Paint Match: +\$1072

Finished in Burnished Oak with a contrasting white interior. Two storage areas behind sliding glass doors with adjustable shelves feature adjustable LED lighting for ambiance. Pairs with 8063-82 Arcadian Sliding Glass Door Credenza.

Country: CHINA Assembly Req: N

8063-84 — Price: \$3447

Arcadian Lateral File

Collection: ARCADIAN

Dimensions: 47w × 22d × 33h Weight: 191 / 191 lbs Cube: 25.3

Standard Finish: Burnished Oak Apron Height: N/A

Materials: White Oak Solids & Veneers

Highlight Striping: N/A

Contrasting Finishes or Paints: +\$862

Conversion Varnish: +\$517

Paint Match: +\$862

Two standard drawers and one lateral file drawer. Open storage area with a USB & Standard Outlet. Cord exit holes for equipment management.

Country: CHINA Assembly Req: Y

8063-85 — Price: \$4287

Arcadian Etageré

Collection: ARCADIAN

Dimensions: 38w × 16d × 84h Weight: 169 / 169 lbs Cube: 38.25

Standard Finish: Burnished Oak Apron Height: 3.12

Materials: White Oak Solids & Veneers, Metal

Highlight Striping: N/A

Contrasting Finishes or Paints: +\$1072

Conversion Varnish: +\$643

Paint Match: +\$1072

Three Storage Shelves. Metal Accents. Finished in Burnished Oak

Country: CHINA Assembly Req: N

8063-90 — Price: \$1107

Arcadian Round Pedestal End Table

Collection: ARCADIAN

Dimensions: 28w × 28d × 28h Weight: 39 / 39 lbs Cube: 4.25

Standard Finish: Burnished Oak Apron Height: N/A

Materials: White Oak Solids & Veneers

Highlight Striping: N/A

Contrasting Finishes or Paints: N/A

Conversion Varnish: +\$450

Paint Match: +\$277

Features a beautiful, turned wood pedestal base with three feet finished in Burnished Oak.

Country: CHINA Assembly Req: Y

8063-92 — Price: \$2787

Arcadian Square Cocktail Table

Collection: ARCADIAN

Dimensions: 48w × 48d × 19h Weight: 147 / 147 lbs Cube: 14.72

Standard Finish: Burnished Oak Apron Height: 2.5

Materials: White Oak Solids & Veneers, Metal

Highlight Striping: N/A

Contrasting Finishes or Paints: +\$697

Conversion Varnish: +\$450

Paint Match: +\$697

Lower Shelf with Metal Accents. Finished In Burnished Oak

Country: CHINA Assembly Req: N

8063-93 — Price: \$2397

Arcadian Rectangular Cocktail Table

Collection: ARCADIAN

Dimensions: 54w × 30d × 19h Weight: 108 / 108 lbs Cube: 12.42

Standard Finish: Burnished Oak Apron Height: 2.5

Materials: White Oak Solids & Veneers, Metal

Highlight Striping: N/A

Contrasting Finishes or Paints: +\$599

Conversion Varnish: +\$450

Paint Match: +\$599

Lower Shelf with Metal Accents. Finished in Burnished Oak

Country: CHINA Assembly Req: N

Casegoods

8063-95 — Price: \$1497

Arcadian Rectangular End Table

Collection: ARCADIAN

Dimensions: 18w × 28d × 26h Weight: 56 / 56 lbs Cube: 5.28

Standard Finish: Burnished Oak Apron Height: 2.5

Materials: White Oak Solids & Veneers, Metal

Highlight Striping: N/A

Contrasting Finishes or Paints: +\$374

Conversion Varnish: +\$450

Paint Match: +\$374

Lower Shelf with Metal Accents. Finished in Burnished Oak

Country: CHINA Assembly Req: N

8063-96 — Price: \$1767

Arcadian Narrow Console Table

Collection: ARCADIAN

Dimensions: 60w × 12d × 35h Weight: 92 / 92 lbs Cube: 6.83

Standard Finish: Burnished Oak Apron Height: N/A

Materials: White Oak Solids & Veneers

Highlight Striping: N/A

Contrasting Finishes or Paints: +\$442

Conversion Varnish: +\$450

Paint Match: +\$442

Features two drawers located on each end of the console and a stationary shelf at the base.

Finished in Burnished Oak.

Country: CHINA Assembly Req: Y

8063-97 — Price: \$2457

Arcadian Five Drawer Chest

Collection: ARCADIAN

Dimensions: 44w × 18d × 36h Weight: 129 / 129 lbs Cube: 19.77

Standard Finish: Burnished Oak Apron Height: N/A

Materials: White Oak Solids & Veneers

Highlight Striping: N/A

Contrasting Finishes or Paints: +\$614

Conversion Varnish: +\$450

Paint Match: +\$614

Finished in Burnished Oak with five drawers.

Country: CHINA Assembly Req: Y

8063-98 — Price: \$2457

Arcadian Drum End Table

Collection: ARCADIAN

Dimensions: 28w × 28d × 24h Weight: 115 / 115 lbs Cube: 14.8

Standard Finish: Burnished Oak Apron Height: N/A

Materials: White Oak Solids & Veneers, Carrara Marble

Highlight Striping: N/A

Contrasting Finishes or Paints: N/A

Conversion Varnish: N/A

Paint Match: +\$614

Finished in Burnished Oak with a white Carrara marble and one interior shelf behind a door.

Country: CHINA Assembly Req: N

8063-99 — Price: \$2487

Arcadian Counter Height Console Table

Collection: ARCADIAN

Dimensions: 68w × 18d × 36h Weight: 132 / 132 lbs Cube: 9.56

Standard Finish: Burnished Oak Apron Height: N/A

Materials: White Oak Solids & Veneers, Carrara Marble

Highlight Striping: N/A

Contrasting Finishes or Paints: +\$622

Conversion Varnish: N/A

Paint Match: +\$622

Counter height console table finished in Burnished Oak with a white Carrara marble top.

Designed with an open end sized appropriately for two counter stools.

Country: CHINA Assembly Req: Y

8063-DT — Price: \$4107

Arcadian Farmhouse Draw Leaf Dining Table

Collection: ARCADIAN

Dimensions: 49w × 30d × 31h Weight: 183 / 183 lbs Cube: 18.45

Standard Finish: Burnished Oak Apron Height: N/A

Materials: White Oak Solids & Veneers

Highlight Striping: N/A

Contrasting Finishes or Paints: +\$1027

Conversion Varnish: +\$616

Paint Match: +\$1027

A classic farmhouse draw table finished in Burnished Oak and featuring two, self-storing leaves.

Country: CHINA Assembly Req: Y

Also Available:

M063-DT in Custom Finishes at \$4947

8063-ET — Price: \$1617

Arcadian Rectangular End Table

Collection: ARCADIAN

Dimensions: 18w × 28d × 27h Weight: 84 / 84 lbs Cube: 10.94

Standard Finish: Burnished Oak Apron Height: N/A

Materials: White Oak Solids & Veneers, Carrara Marble

Highlight Striping: N/A

Contrasting Finishes or Paints: N/A

Conversion Varnish: +\$450

Paint Match: +\$404

Features an inset Carrara marble top with one fixed shelf. Finished in Burnished Oak.

Country: CHINA Assembly Req: N

8063-FT — Price: \$1977

Arcadian Flip-Top Console Table

Collection: ARCADIAN

Dimensions: 60w × 16d × 30h Weight: 79 / 79 lbs Cube: 16.66

Standard Finish: Burnished Oak Apron Height: N/A

Materials: White Oak Solids & Veneers

Highlight Striping: N/A

Contrasting Finishes or Paints: +\$494

Conversion Varnish: +\$450

Paint Match: +\$494

Features an expandable top with two attached leaves. Finished in Burnished Oak.

Country: CHINA Assembly Req: Y

Casegoods

8063-HT — Price: \$2247

Arcadian Open Storage Console Table

Collection: ARCADIAN

Dimensions: 72w × 16d × 36h Weight: 118 / 118 lbs Cube: 17.41

Standard Finish: Burnished Oak Apron Height: N/A

Materials: White Oak Solids & Veneers, Metal

Highlight Striping: N/A

Contrasting Finishes or Paints: +\$562

Conversion Varnish: +\$450

Paint Match: +\$562

Features an open storage console table with an X-frame metal base. Finished in Burnished Oak.

Country: CHINA Assembly Req: N

8063-LD — Price: \$2277

Arcadian Lateral File Deck

Collection: ARCADIAN

Dimensions: 44.75w × 12.25d × 42h Weight: 49 / 49 lbs Cube: 18.75

Standard Finish: Burnished Oak Apron Height: N/A

Materials: White Oak Solids & Veneers, Metal

Highlight Striping: N/A

Contrasting Finishes or Paints: N/A

Conversion Varnish: +\$450

Paint Match: +\$569

Finished in Burnished Oak with two inset glass shelves and adjustable LED lighting. Pairs with 8063-84 Arcadian Lateral File, includes mending plates for attachment to the Lateral File.

Country: CHINA Assembly Req: Y

8063-MC — Price: \$4227

Arcadian Media Credenza

Collection: ARCADIAN

Dimensions: 84w × 20d × 36h Weight: 273 / 273 lbs Cube: 35.99

Standard Finish: Burnished Oak Apron Height: N/A

Materials: White Oak Solids & Veneers

Highlight Striping: N/A

Contrasting Finishes or Paints: +\$1057

Conversion Varnish: +\$634

Paint Match: +\$1057

Features a raised platform for television mounting and media console storage. Features four drawers and two wooden framed glass sliding doors with a fixed shelf and cord exit holes. Finished in Burnished Oak.

Country: CHINA Assembly Req: N

8063-MF — Price: \$1497

Arcadian Mobile File

Collection: ARCADIAN

Dimensions: 15.5w × 18d × 25.5h Weight: 97 / 97 lbs Cube: 7.2

Standard Finish: Burnished Oak Apron Height: N/A

Materials: White Oak Solids & Veneers

Highlight Striping: N/A

Contrasting Finishes or Paints: +\$374

Conversion Varnish: +\$450

Paint Match: +\$374

Features one standard top level drawer, one lateral file drawer, and one hidden drawer. Finished in Burnished Oak.

Country: CHINA Assembly Req: N

8063-ST — Price: \$2487

Arcadian Console

Collection: ARCADIAN

Dimensions: 72w × 14d × 34h Weight: 104 / 104 lbs Cube: 11.09

Standard Finish: Burnished Oak Apron Height: 4

Materials: White Oak Solids & Veneers, Metal

Highlight Striping: N/A

Contrasting Finishes or Paints: N/A

Conversion Varnish: +\$450

Paint Match: +\$622

Lower Shelf with Metal Accents. Finished in Burnished Oak

Country: CHINA Assembly Req: N

8063-TB — Price: \$2427

Arcadian Single Pedestal Table Base

Collection: ARCADIAN

Dimensions: 26w × 26d × 27.5h Weight: 67 / 67 lbs Cube: 12.86

Standard Finish: Burnished Oak Apron Height: N/A

Materials: White Oak Solids & Veneers

Highlight Striping: N/A

Contrasting Finishes or Paints: N/A

Conversion Varnish: N/A

Paint Match: +\$607

Turned pedestal wood table base finished in Burnished Oak. Pairs with 8063-48 and 8063-60, Arcadian 48" and 60" Round Dining Table Tops.

Country: CHINA Assembly Req: Y

8065-89 — Price: \$1437

Highland Ridge Drop Leaf Table

Collection:

Dimensions: 36w × 14d × 30h Weight: 55 / 55 lbs Cube: 9.98

Standard Finish: Brushed Linen Apron Height: N/A

Materials:

Highlight Striping: N/A

Contrasting Finishes or Paints: N/A

Conversion Varnish: +\$450

Paint Match: +\$359

Country: CHINA Assembly Req: N

8066-99 — Price: \$3177

Coeur d'Alene Console Table

Collection: COEUR D'ALENE

Dimensions: 72w × 16d × 32h Weight: 154 / 154 lbs Cube: 29.7

Standard Finish: Reclaimed Oak Apron Height: N/A

Materials: Red Oak Solids & Veneers

Highlight Striping: N/A

Contrasting Finishes or Paints: +\$794

Conversion Varnish: +\$477

Paint Match: +\$794

Large, circular design elements create a sculptural silhouette, finished in Reclaimed Oak. Also available in any Monogram Finish as M066-99.

Country: CHINA Assembly Req: N

Also Available:

M066-99 in Custom Finishes at \$3987

Casegoods

8067-48 — Price: \$1347

Beveled Edge 48" Dining Table Top

Collection:

Dimensions: 48w × 48d × 1h **Weight:** 68 / 68 lbs **Cube:** 6.13

Standard Finish: Sheer Dove **Apron Height:** N/A

Materials: Walnut Solids & Veneers

Highlight Striping: N/A **Contrasting Finishes or Paints:** N/A

Conversion Varnish: +\$450 **Paint Match:** +\$337

Finished in Sheer Dove with a pie-shaped veneer design. Pairs with 8067-TB Serpentine Shaped Leg Dining Pedestal Base. Also available in any Monogram Finish as M067-48.

Country: CHINA **Assembly Req:** Y

Also Available:

M067-48 in Custom Finishes at \$2487

8067-60 — Price: \$1827

Beveled Edge 60" Dining Table Top

Collection:

Dimensions: 60w × 60d × 1h **Weight:** 98 / 98 lbs **Cube:** 8.61

Standard Finish: Sheer Dove **Apron Height:** N/A

Materials: Walnut Solids & Veneers

Highlight Striping: N/A **Contrasting Finishes or Paints:** N/A

Conversion Varnish: +\$450 **Paint Match:** +\$457

Finished in Sheer Dove with a pie-shaped veneer design. Pairs with 8067-TB Serpentine Shaped Leg Dining Pedestal Base. Also available in any Monogram Finish as M067-60.

Country: CHINA **Assembly Req:** Y

Also Available:

M067-60 in Custom Finishes at \$3087

8067-TB — Price: \$2637

Serpentine Shaped Leg Dining Pedestal Base

Collection:

Dimensions: 36w × 36d × 28.5h **Weight:** 52 / 52 lbs **Cube:** 26.32

Standard Finish: Sheer Dove **Apron Height:** 28.5

Materials: Walnut Solids & Veneers

Highlight Striping: N/A **Contrasting Finishes or Paints:** N/A

Conversion Varnish: N/A **Paint Match:** +\$659

Finished in Sheer Dove with Nickel ferrules. Pairs with 8067-60 and 8067-48, Beveled Edge 48 and 60" Dining Table Tops. Also available in any Monogram Finish as M067-TB.

Country: CHINA **Assembly Req:** Y

Also Available:

M067-TB in Custom Finishes at \$3507

8069-TB — Price: \$1797

C-Ring Pedestal Base

Collection:

Dimensions: 32.5w × 32.5d × 29h **Weight:** 50 / 50 lbs **Cube:** 22.33

Standard Finish: Sheer Dove **Apron Height:** 29

Materials: Walnut Solids & Veneers

Highlight Striping: N/A **Contrasting Finishes or Paints:** N/A

Conversion Varnish: N/A **Paint Match:** +\$449

Finished in Sheer Dove with Nickel cap accents. Pairs with 8067-60 and 8067-48, Beveled Edge 48 and 60" Dining Table Tops. Also available in any Monogram Finish as M069-TB.

Country: CHINA **Assembly Req:** Y

Also Available:

M069-TB in Custom Finishes at \$2847

8080-90-C — Price: \$1197

Helena End Table

Collection:

Dimensions: 24w × 24d × 24h **Weight:** 39 / 39 lbs **Cube:** 8

Standard Finish: Charcoal **Apron Height:** N/A

Materials: White Oak Solids and Veneers

Highlight Striping: N/A **Contrasting Finishes or Paints:** N/A

Conversion Varnish: +\$450 **Paint Match:** +\$299

Also available in any Monogram Finish as M080-90

Country: CHINA **Assembly Req:** N

Also Available:

M080-90 in Custom Finishes at \$1797

8080-99-C — Price: \$1497

Helena Console Table

Collection:

Dimensions: 52w × 18d × 34h **Weight:** 83 / 83 lbs **Cube:** 18.41

Standard Finish: Charcoal **Apron Height:** N/A

Materials: White Oak Solids and Veneers

Highlight Striping: N/A **Contrasting Finishes or Paints:** N/A

Conversion Varnish: +\$450 **Paint Match:** +\$374

Also available in any Monogram Finish as M080-99

Country: CHINA **Assembly Req:** N

Also Available:

M080-99 in Custom Finishes at \$2697

8080-ET-C — Price: \$1137

Helena Nesting Table

Collection:

Dimensions: 22w × 22d × 25h **Weight:** 21 / 21 lbs **Cube:** 7

Standard Finish: Charcoal **Apron Height:** N/A

Materials: White Oak Solids and Veneers

Highlight Striping: N/A **Contrasting Finishes or Paints:** N/A

Conversion Varnish: +\$450 **Paint Match:** +\$284

Also available in any Monogram Finish as M080-ET

Country: CHINA **Assembly Req:** N

Also Available:

M080-ET in Custom Finishes at \$1737

8081-10 — Price: \$1737

Sundries Bench

Collection: SUNDRIES

Dimensions: 53w × 19d × 19h **Weight:** 40 / 40 lbs **Cube:** 16.33

Standard Finish: Ochre **Apron Height:** N/A

Materials: Mango Solids

Highlight Striping: N/A **Contrasting Finishes or Paints:** N/A

Conversion Varnish: N/A **Paint Match:** N/A

Finished in Ochre with Jute webbed seating and a metal stretcher. Features natural cane accents that was handwoven using the peel of natural rattan. As with any natural product, nature's imperfections and hallmarks will be present in the cane materials. Cane is a handcrafted product dating back to the Ancient Egyptians.

Country: INDIA **Assembly Req:** N

Casegoods

8084-CH — Price: \$2727

Lizzie Coeur d'Alene Chest

Collection: COEUR D'ALENE

Dimensions: 43w × 23d × 38h **Weight:** 68 / 68 lbs **Cube:** 28.37

Standard Finish: Flint **Apron Height:** N/A

Materials: Maple Solids & Veneers

Highlight Striping: +\$450

Contrasting Finishes or Paints: +\$682

Conversion Varnish: +\$450

Paint Match: +\$682

Finished in Flint with antique brass hardware and four drawers. Also available in any Monogram Finish as M084-CH.

Country: CHINA **Assembly Req:** N

Also Available:

M084-CH in Custom Finishes at \$3687

8085-MC — Price: \$2697

Phoenix Credenza

Collection:

Dimensions: 80w × 15d × 34h **Weight:** 215 / 215 lbs **Cube:** 23.61

Standard Finish: Grecian Clay **Apron Height:** N/A

Materials: Figured Eucalyptus

Highlight Striping: N/A

Contrasting Finishes or Paints: +\$674

Conversion Varnish: +\$450

Paint Match: +\$674

Four doors with one adjustable shelf behind each door. Cord exit on back panel. Exterior in Grecian Clay with doors in Creme Brule Finish. Also available in any Fairfield Finish M085-MC

Country: CHINA **Assembly Req:** N

Also Available:

M085-MC in Custom Finishes at \$3897

8089-46-G — Price: \$2937

Monier Cocktail Table

Collection: MONIER

Dimensions: 56w × 32d × 18h **Weight:** 115 / 115 lbs **Cube:** 31.82

Standard Finish: Antique Gold **Apron Height:** N/A

Materials: Faux-Bois Metal, Glass Top

Highlight Striping: N/A

Contrasting Finishes or Paints: N/A

Conversion Varnish: N/A

Paint Match: N/A

Country: INDIA **Assembly Req:** N

Also Available:

8089-46-M in Antique Gold at \$3297

8089-46-M — Price: \$3297

Monier Cocktail Table

Collection: MONIER

Dimensions: 56w × 32d × 18h **Weight:** 0 / 0 lbs **Cube:** 32.23

Standard Finish: Antique Gold **Apron Height:** N/A

Materials: Faux-Bois Metal, Calcutta Stone

Highlight Striping: N/A

Contrasting Finishes or Paints: N/A

Conversion Varnish: N/A

Paint Match: N/A

Country: INDIA **Assembly Req:** N

Also Available:

8089-46-G in Antique Gold at \$2937

8089-93-G — Price: \$2967

Monier Cocktail Table

Collection: MONIER

Dimensions: 54w × 34.5d × 17h **Weight:** 113 / 113 lbs **Cube:** 28.49

Standard Finish: Antique Gold **Apron Height:** N/A

Materials: Faux-Bois Metal, Glass Top

Highlight Striping: N/A

Contrasting Finishes or Paints: N/A

Conversion Varnish: N/A

Paint Match: N/A

Country: INDIA **Assembly Req:** N

Also Available:

8089-93-M in Antique Gold at \$3387

8089-93-M — Price: \$3387

Monier Cocktail Table

Collection: MONIER

Dimensions: 54w × 34.5d × 17h **Weight:** 181 / 181 lbs **Cube:** 30.48

Standard Finish: Antique Gold **Apron Height:** N/A

Materials: Faux-Bois Metal, Calcutta Stone

Highlight Striping: N/A

Contrasting Finishes or Paints: N/A

Conversion Varnish: N/A

Paint Match: N/A

Country: INDIA **Assembly Req:** N

Also Available:

8089-93-G in Antique Gold at \$2967

8089-94-G — Price: \$2007

Monier End Table

Collection: MONIER

Dimensions: 28w × 28.5d × 24h **Weight:** 39 / 39 lbs **Cube:** 0.46

Standard Finish: Antique Gold **Apron Height:** N/A

Materials: Faux-Bois Metal, Glass Top

Highlight Striping: N/A

Contrasting Finishes or Paints: N/A

Conversion Varnish: N/A

Paint Match: N/A

Country: INDIA **Assembly Req:** N

Also Available:

8089-94-M in Antique Gold at \$2187

8089-94-M — Price: \$2187

Monier End Table

Collection: MONIER

Dimensions: 28w × 28.5d × 24h **Weight:** 89 / 89 lbs **Cube:** 17.34

Standard Finish: Antique Gold **Apron Height:** N/A

Materials: Faux-Bois Metal, Calcutta Stone

Highlight Striping: N/A

Contrasting Finishes or Paints: N/A

Conversion Varnish: N/A

Paint Match: N/A

Country: INDIA **Assembly Req:** N

Also Available:

8089-94-G in Antique Gold at \$2007

Casegoods

8089-99-G — Price: \$3237

Monier Hall Console Table

Collection: MONIER

Dimensions: 71w × 17.3d × 37h Weight: 127 / 127 lbs Cube: 42.29

Standard Finish: Antique Gold Apron Height: N/A

Materials: Faux-Bois Metal, Glass Top

Highlight Striping: N/A

Contrasting Finishes or Paints: N/A

Conversion Varnish: N/A

Paint Match: N/A

Country: INDIA Assembly Req: N

Also Available:

8089-99-M in Antique Gold at \$3627

8089-99-M — Price: \$3627

Monier Hall Console Table

Collection: MONIER

Dimensions: 71w × 17.3d × 37h Weight: 189 / 189 lbs Cube: 40.38

Standard Finish: Antique Gold Apron Height: N/A

Materials: Faux-Bois Metal, Calcutta Stone

Highlight Striping: N/A

Contrasting Finishes or Paints: N/A

Conversion Varnish: N/A

Paint Match: N/A

Country: INDIA Assembly Req: N

Also Available:

8089-99-G in Antique Gold at \$3237

8089-CS-G — Price: \$1827

Monier Chairside Table

Collection: MONIER

Dimensions: 29.25w × 29.25d × 24h Weight: 26 / 26 lbs Cube: 11.87

Standard Finish: Antique Gold Apron Height: N/A

Materials: Faux-Bois Metal, Glass Top

Highlight Striping: N/A

Contrasting Finishes or Paints: N/A

Conversion Varnish: N/A

Paint Match: N/A

Features a faux bois metal base finished in Antique Gold and a glass top. Consists of B-8089-CS-G (Base) and T-8089-CS-G (Top)

Country: INDIA Assembly Req: N

Also Available:

8089-CS-M in Antique Gold at \$1917

8089-CS-M — Price: \$1917

Monier Chairside Table

Collection: MONIER

Dimensions: 29.25w × 29.25d × 24h Weight: 78 / 78 lbs Cube: 14.21

Standard Finish: Antique Gold Apron Height: N/A

Materials: Faux-Bois Metal, Calcutta Stone

Highlight Striping: N/A

Contrasting Finishes or Paints: N/A

Conversion Varnish: N/A

Paint Match: N/A

Country: INDIA Assembly Req: N

Also Available:

8089-CS-G in Antique Gold at \$1827

8092-17 — Price: \$6447

Cheñeais Credenza

Collection: CHEÑEAIS

Dimensions: 84w × 19d × 38h Weight: 351 / 351 lbs Cube: 48.05

Standard Finish: French Oak Apron Height: N/A

Materials: Select Red Oak Solids & Veneers

Highlight Striping: N/A

Contrasting Finishes or Paints: +\$1612

Conversion Varnish: N/A

Paint Match: +\$1612

Finished in French Oak with inset stone top, three doors, two drawers, and four interior adjustable shelves. Hardware finished in Oiled Antique Bronze. Also available in any Monogram Finish as M092-17.

Country: CHINA Assembly Req: N

Also Available:

M092-17 in Custom Finishes at \$8487

8092-19 — Price: \$1857

Cheñeais End Table

Collection: CHEÑEAIS

Dimensions: 25w × 25d × 25h Weight: 64 / 64 lbs Cube: 13.36

Standard Finish: French Oak Apron Height: N/A

Materials: Select Red Oak Solids & Veneers

Highlight Striping: N/A

Contrasting Finishes or Paints: N/A

Conversion Varnish: N/A

Paint Match: +\$464

Finished in French Oak with inset stone top and one fixed shelf. Also available in any Monogram Finish as M092-19

Country: CHINA Assembly Req: N

Also Available:

M092-19 in Custom Finishes at \$2577

8092-92 — Price: \$3207

Cheñeais Square Cocktail Table

Collection: CHEÑEAIS

Dimensions: 48w × 48d × 20h Weight: 175 / 175 lbs Cube: 34.61

Standard Finish: French Oak Apron Height: N/A

Materials: Select Red Oak Solids

Highlight Striping: N/A

Contrasting Finishes or Paints: N/A

Conversion Varnish: +\$481

Paint Match: +\$802

Finished in French Oak with an inset glass top and decorative metal stretcher. Also available in any Monogram Finish as M092-92

Country: CHINA Assembly Req: Y

Also Available:

M092-92 in Custom Finishes at \$4287

8092-98 — Price: \$1197

Cheñeais Round Lamp Table

Collection: CHEÑEAIS

Dimensions: 25w × 25d × 26h Weight: 56 / 56 lbs Cube: 14.57

Standard Finish: French Oak Apron Height: N/A

Materials: Select Red Oak Solids & Veneers

Highlight Striping: N/A

Contrasting Finishes or Paints: N/A

Conversion Varnish: +\$450

Paint Match: +\$299

Finished in French Oak with one fixed shelf. Also available in any Monogram Finish as M092-98

Country: CHINA Assembly Req: N

Also Available:

M092-98 in Custom Finishes at \$2067

Casegoods

8092-DT — Price: \$5937

Cheñeais Dining Table

Collection: CHENEAIS

Dimensions: 90w × 46d × 30h **Weight:** 487 / 487 lbs **Cube:** 82.18

Standard Finish: French Oak **Apron Height:** N/A

Materials: Select Red Oak Solids & Veneers

Highlight Striping: N/A

Contrasting Finishes or Paints: N/A

Conversion Varnish: +\$891

Paint Match: +\$1484

Finished in French Oak. Width with one 22" leaf is 112" and with two 22" leaves is 134". Consists of 8092-DT-B (Base) and 8092-DT-T (Top). Also available in any Monogram Finish as M092-DT.

Country: CHINA **Assembly Req:** Y

Also Available:

M092-DT in Custom Finishes at \$8397

8096-16 — Price: \$1647

West Camden Dining Table Base

Collection: WEST CAMDEN

Dimensions: 30w × 30d × 29.5h **Weight:** 67 / 67 lbs **Cube:** 18.08

Standard Finish: Tahitian Pearl **Apron Height:** N/A

Materials: Metal, Walnut Solids and Veneers

Highlight Striping: N/A

Contrasting Finishes or Paints: N/A

Conversion Varnish: N/A

Paint Match: +\$412

Black Steel metal with wood base in Tahitian Pearl Finish. Pairs with GLAS-54 54" Glass Top and GLAS-60 60" Glass Top. Also available in any Monogram Finish as M096-16.

Country: CHINA **Assembly Req:** N

Also Available:

M096-16 in Custom Finishes at \$2187

8096-19 — Price: \$897

West Camden Round End Table

Collection: WEST CAMDEN

Dimensions: 22w × 22d × 24h **Weight:** 44 / 44 lbs **Cube:** 10.07

Standard Finish: Tahitian Pearl **Apron Height:** N/A

Materials: Metal, Walnut Solids and Veneers

Highlight Striping: N/A

Contrasting Finishes or Paints: N/A

Conversion Varnish: +\$450

Paint Match: +\$224

Finished in Tahitian Pearl with Black Steel metal frame. Also available in any Monogram Finish as M096-19

Country: CHINA **Assembly Req:** N

Also Available:

M096-19 in Custom Finishes at \$1497

8096-38 — Price: \$2007

West Camden Drawer Chest

Collection: WEST CAMDEN

Dimensions: 36w × 20d × 32h **Weight:** 44 / 44 lbs **Cube:** 18.19

Standard Finish: Tahitian Pearl **Apron Height:** N/A

Materials: Metal, Walnut Solids and Veneers

Highlight Striping: N/A

Contrasting Finishes or Paints: +\$502

Conversion Varnish: +\$450

Paint Match: +\$502

Finished in Tahitian Pearl with Black Steel metal accents, and three self-closing drawers with scallop-carved fronts. Also available in any Monogram Finish as M096-38.

Country: CHINA **Assembly Req:** N

Also Available:

M096-38 in Custom Finishes at \$3237

8096-44 — Price: \$3597

West Camden Dining Table

Collection: WEST CAMDEN

Dimensions: 60w × 60d × 32h **Weight:** 238 / 238 lbs **Cube:** 36.07

Standard Finish: Tahitian Pearl **Apron Height:** N/A

Materials: Walnut Solids and Veneers

Highlight Striping: N/A

Contrasting Finishes or Paints: N/A

Conversion Varnish: +\$540

Paint Match: +\$899

Features One 22" leaf. Finished in Tahitian Pearl Finish. Consists of 8096-44-T top & 8096-44-B base. Also available in any Monogram Finish as M096-44.

Country: CHINA **Assembly Req:** Y

Also Available:

M096-44 in Custom Finishes at \$4797

8096-81 — Price: \$1767

West Camden Writing Desk

Collection: WEST CAMDEN

Dimensions: 58w × 30d × 30h **Weight:** 130 / 130 lbs **Cube:** 11.31

Standard Finish: Tahitian Pearl **Apron Height:** N/A

Materials: Metal, Walnut Solids and Veneers

Highlight Striping: N/A

Contrasting Finishes or Paints: +\$442

Conversion Varnish: +\$450

Paint Match: +\$442

Finished in Tahitian Pearl with Black Steel metal accents and three soft-close drawers. Sized to pair with 8096-MF West Camden Mobile File.

Country: CHINA **Assembly Req:** Y

8096-82 — Price: \$3897

West Camden Credenza

Collection: WEST CAMDEN

Dimensions: 78w × 20d × 34h **Weight:** 293 / 293 lbs **Cube:** 39.21

Standard Finish: Tahitian Pearl **Apron Height:** N/A

Materials: Walnut Solids and Veneers

Highlight Striping: +\$450

Contrasting Finishes or Paints: +\$974

Conversion Varnish: +\$585

Paint Match: +\$974

Features Four doors with an adjustable shelf behind each door. Black Steel hardware. Also available in any Monogram Finish as M096-82.

Country: CHINA **Assembly Req:** N

Also Available:

M096-82 in Custom Finishes at \$5097

8096-83 — Price: \$2697

West Camden Lateral File Deck

Collection: WEST CAMDEN

Dimensions: 45.5w × 14.25d × 45.75h **Weight:** 140 / 140 lbs **Cube:** 17.16

Standard Finish: Tahitian Pearl **Apron Height:** N/A

Materials: Metal, Walnut Solids and Veneers

Highlight Striping: N/A

Contrasting Finishes or Paints: N/A

Conversion Varnish: +\$450

Paint Match: +\$674

Finished in Tahitian Pearl with oval, Black Steel metal accents on the end panels and three-way adjustable touch lighting with three adjustable glass shelves.

Country: CHINA **Assembly Req:** Y

Casegoods

8096-84 — Price: \$2997

West Camden Lateral File Cabinet

Collection: WEST CAMDEN

Dimensions: 47.5w × 20d × 33h Weight: 176 / 176 lbs Cube: 18.14

Standard Finish: Tahitian Pearl Apron Height: N/A

Materials: Metal, Walnut Solids and Veneers

Highlight Striping: N/A

Contrasting Finishes or Paints: +\$749

Conversion Varnish: +\$450

Paint Match: +\$749

Finished in Tahitian Pearl with Black Steel hardware and scallop-carved drawer and door fronts. Two doors with interior storage housing adjustable shelves, standard outlet with a dual USB port, and cord exit holes. Two bottom lateral file drawers. Use alone or pair with 8096-83, West Camden Deck.

Country: CHINA Assembly Req: N

8096-86 — Price: \$2037

West Camden Center Hall Table

Collection: WEST CAMDEN

Dimensions: 38w × 38d × 30h Weight: 133 / 133 lbs Cube: 0

Standard Finish: Tahitian Pearl Apron Height: N/A

Materials: Walnut Solids and Veneers

Highlight Striping: N/A

Contrasting Finishes or Paints: N/A

Conversion Varnish: +\$450

Paint Match: N/A

Finished in Tahitian Pearl with Black Steel metal accents Pairs with 8096-86-B, West Camden Base.

Country: CHINA Assembly Req: Y

8096-93 — Price: \$1047

West Camden Rectangular Cocktail Table

Collection: WEST CAMDEN

Dimensions: 42w × 20d × 18h Weight: 45 / 45 lbs Cube: 4.67

Standard Finish: Tahitian Pearl Apron Height: N/A

Materials: Metal, Walnut Solids and Veneers

Highlight Striping: N/A

Contrasting Finishes or Paints: N/A

Conversion Varnish: +\$450

Paint Match: +\$262

Tray top finished in Tahitian Pearl with Black Steel metal base. Also available in any Monogram Finish as M096-93

Country: CHINA Assembly Req: N

Also Available:

M096-93 in Custom Finishes at \$1647

8096-94 — Price: \$627

West Camden Drink Table

Collection: WEST CAMDEN

Dimensions: 14w × 14d × 22h Weight: 23 / 23 lbs Cube: 4.09

Standard Finish: Tahitian Pearl Apron Height: N/A

Materials: Metal, Walnut Solids and Veneers

Highlight Striping: N/A

Contrasting Finishes or Paints: N/A

Conversion Varnish: +\$450

Paint Match: +\$157

Tray top finished in Tahitian Pearl with Black Steel metal base. Also available in any Monogram Finish as M096-94

Country: CHINA Assembly Req: N

Also Available:

M096-94 in Custom Finishes at \$1197

8096-96 — Price: \$3597

West Camden Credenza

Collection: WEST CAMDEN

Dimensions: 72w × 20d × 34h Weight: 256 / 256 lbs Cube: 28.33

Standard Finish: Tahitian Pearl Apron Height: N/A

Materials: Metal, Walnut Solids and Veneers

Highlight Striping: +\$450

Contrasting Finishes or Paints: +\$899

Conversion Varnish: +\$540

Paint Match: +\$899

Features two doors with two interior adjustable shelves. Finished in Tahitian Pearl with metal base and hardware in Black Steel. Also available in any Monogram Finish as M096-96.

Country: CHINA Assembly Req: N

Also Available:

M096-96 in Custom Finishes at \$4797

8096-97 — Price: \$2697

West Camden Drawer Chest

Collection: WEST CAMDEN

Dimensions: 42w × 20d × 40h Weight: 143 / 143 lbs Cube: 19.44

Standard Finish: Tahitian Pearl Apron Height: N/A

Materials: Metal, Walnut Solids and Veneers

Highlight Striping: N/A

Contrasting Finishes or Paints: +\$674

Conversion Varnish: +\$450

Paint Match: +\$674

Finished in Tahitian Pearl with acrylic and Black Steel hardware, five reeded-front drawers with self-closing drawer guides. Also available in any Monogram Finish as M096-97.

Country: CHINA Assembly Req: N

Also Available:

M096-97 in Custom Finishes at \$3777

8096-98 — Price: \$1677

West Camden End Table

Collection: WEST CAMDEN

Dimensions: 28w × 22d × 24h Weight: 60 / 60 lbs Cube: 8.55

Standard Finish: Tahitian Pearl Apron Height: N/A

Materials: Metal, Carrara Marble, & Glass

Highlight Striping: N/A

Contrasting Finishes or Paints: N/A

Conversion Varnish: N/A

Paint Match: N/A

Finished in Tahitian Pearl with Black Steel accents, Carrara marble top, and one fixed glass shelf.

Country: CHINA Assembly Req: N

8096-AD — Price: \$2697

West Camden Writing Desk

Collection: WEST CAMDEN

Dimensions: 58w × 28d × 30h Weight: 172 / 172 lbs Cube: 21.62

Standard Finish: Tahitian Pearl Apron Height: N/A

Materials: Metal, Walnut Solids and Veneers

Highlight Striping: N/A

Contrasting Finishes or Paints: +\$674

Conversion Varnish: +\$450

Paint Match: +\$674

Features four soft close drawers. One pencil tray and hidden storage compartment. Finished in Tahitian Pearl with Black Steel accents.

Country: CHINA Assembly Req: Y

Casegoods

8096-BS — Price: \$1887

West Camden Nightstand

Collection: WEST CAMDEN
Dimensions: 36w × 20d × 33.2h
Standard Finish: Tahitian Pearl
Materials: Walnut, Metal Accents
Highlight Striping: N/A
Conversion Varnish: +\$450

Weight: 157 / 157 lbs **Cube:** 13.83
Apron Height: N/A
Contrasting Finishes or Paints: +\$472
Paint Match: +\$472

Features one drawer and one pull out shelf with Black Steel hardware and Tahitian Pearl Finish. All drawers feature full extension and self-closing hardware. Also available in any Fairfield Finish M096-BS.

Country: VIETNAM **Assembly Req:** N
Also Available:
M096-BS in Custom Finishes at \$2397

8096-CS — Price: \$867

West Camden End Table

Collection: WEST CAMDEN
Dimensions: 16w × 28d × 24h
Standard Finish: Tahitian Pearl
Materials: Walnut Solids and Veneers
Highlight Striping: N/A
Conversion Varnish: +\$450

Weight: 46 / 46 lbs **Cube:** 9.12
Apron Height: N/A
Contrasting Finishes or Paints: N/A
Paint Match: +\$217

Finished in Tahitian Pearl with one pull-out shelf and two fixed shelves. Also available in any Monogram Finish as M096-CS

Country: CHINA **Assembly Req:** N
Also Available:
M096-CS in Custom Finishes at \$1437

8096-CT — Price: \$1437

West Camden Round Cocktail Table

Collection: WEST CAMDEN
Dimensions: 44w × 44d × 19h
Standard Finish: Tahitian Pearl
Materials: Metal, Walnut Solids and Veneers
Highlight Striping: N/A
Conversion Varnish: +\$450

Weight: 81 / 81 lbs **Cube:** 8.22
Apron Height: N/A
Contrasting Finishes or Paints: N/A
Paint Match: +\$359

Finished in Tahitian Pearl with Black Steel accents. Also available in any Monogram Finish as M096-CT

Country: CHINA **Assembly Req:** N
Also Available:
M096-CT in Custom Finishes at \$2097

8096-DC — Price: \$2847

West Camden Master Chest

Collection: WEST CAMDEN
Dimensions: 60w × 20d × 38h
Standard Finish: Tahitian Pearl
Materials: Walnut, Metal Accents
Highlight Striping: N/A
Conversion Varnish: +\$450

Weight: 271 / 271 lbs **Cube:** 26.38
Apron Height: N/A
Contrasting Finishes or Paints: +\$712
Paint Match: +\$712

Features six drawers with Black Steel hardware and Tahitian Pearl Finish. All drawers feature full extension and self-closing hardware. Also available in any Fairfield Finish M096-DC

Country: VIETNAM **Assembly Req:** N
Also Available:
M096-DC in Custom Finishes at \$3597

8096-DK — Price: \$1947

West Camden Desk

Collection: WEST CAMDEN
Dimensions: 42w × 22d × 30h
Standard Finish: Tahitian Pearl
Materials: Walnut, Metal Accents
Highlight Striping: N/A
Conversion Varnish: +\$450

Weight: 79 / 79 lbs **Cube:** 16.04
Apron Height: N/A
Contrasting Finishes or Paints: +\$487
Paint Match: +\$487

Features one drawer with drop down drawer front. Black Steel hardware and Tahitian Pearl Finish. All drawers feature full extension and self-closing hardware. Also available in any Fairfield Finish M096-DK

Country: VIETNAM **Assembly Req:** N
Also Available:
M096-DK in Custom Finishes at \$2397

8096-DT — Price: \$3897

West Camden Round Dining Table

Collection: WEST CAMDEN
Dimensions: 72w × 72d × 30h
Standard Finish: Tahitian Pearl
Materials: Walnut Solids and Veneers
Highlight Striping: N/A
Conversion Varnish: +\$585

Weight: 272 / 272 lbs **Cube:** 38.38
Apron Height: N/A
Contrasting Finishes or Paints: N/A
Paint Match: +\$974

72" round dining table top finished in Tahitian Pearl. Consist of 8096-DT-B (Base) and 8096-DT-T (Top). Also available in any Monogram Finish as M096-DT.

Country: CHINA **Assembly Req:** Y
Also Available:
M096-DT in Custom Finishes at \$5247

8096-ET — Price: \$897

West Camden End Table

Collection: WEST CAMDEN
Dimensions: 22w × 22d × 24h
Standard Finish: Tahitian Pearl
Materials: Metal, Walnut Solids and Veneers
Highlight Striping: N/A
Conversion Varnish: +\$450

Weight: 35 / 35 lbs **Cube:** 9.74
Apron Height: N/A
Contrasting Finishes or Paints: N/A
Paint Match: +\$224

Tray top finished in Tahitian Pearl with Black Steel metal base. Also available in any Monogram Finish as M096-ET

Country: CHINA **Assembly Req:** N
Also Available:
M096-ET in Custom Finishes at \$1437

8096-HT — Price: \$987

West Camden Console Table

Collection: WEST CAMDEN
Dimensions: 46w × 14d × 34h
Standard Finish: Tahitian Pearl
Materials: Walnut Solids and Veneers
Highlight Striping: N/A
Conversion Varnish: +\$450

Weight: 45 / 45 lbs **Cube:** 5.14
Apron Height: N/A
Contrasting Finishes or Paints: N/A
Paint Match: +\$247

Tray top finished in Tahitian Pearl with Black Steel metal base. Also available in any Monogram Finish as M096-HT

Country: CHINA **Assembly Req:** N
Also Available:
M096-HT in Custom Finishes at \$1647

Casegoods

8096-KB-E — Price: \$3747

West Camden King Bed

Collection: WEST CAMDEN

Dimensions: 81w × 85.5d × 71h

Standard Finish: Tahitian Pearl

Materials: Walnut

Highlight Striping: N/A

Conversion Varnish: N/A

Weight: 330 / 330 lbs

Cube: 284.55

Apron Height: N/A

Contrasting Finishes or Paints: N/A

Paint Match: N/A

Married in 3343-Ecru fabric (Grade T, Cleaning Code S),Tahitian Pearl Finish. Custom upholstery options are not available.

Country: VIETNAM Assembly Req: Y

Also Available:

M096-KB in Custom Options starting at \$4947

8096-KH-B — Price: \$3747

West Camden King Bed

Collection: WEST CAMDEN

Dimensions: 81w × 85.5d × 60h

Standard Finish: Tahitian Pearl

Materials: Walnut

Highlight Striping: N/A

Conversion Varnish: N/A

Weight: 300 / 300 lbs

Cube: 240.46

Apron Height: N/A

Contrasting Finishes or Paints: N/A

Paint Match: N/A

Married in 1158 Bisque leather (Grade 4),Tahitian Pearl Finish. Custom upholstery options are not available.

Country: VIETNAM Assembly Req: Y

Also Available:

M096-KH in Custom Options starting at \$4947

8096-KH-E — Price: \$3447

West Camden King Bed

Collection: WEST CAMDEN

Dimensions: 81w × 85.5d × 60h

Standard Finish: Tahitian Pearl

Materials: Walnut

Highlight Striping: N/A

Conversion Varnish: N/A

Weight: 300 / 300 lbs

Cube: 240.46

Apron Height: N/A

Contrasting Finishes or Paints: N/A

Paint Match: N/A

Married in 3343-Ecru fabric (Grade T, Cleaning Code S),Tahitian Pearl Finish. Custom upholstery options are not available.

Country: VIETNAM Assembly Req: Y

Also Available:

M096-KH in Custom Options starting at \$4947

8096-MF — Price: \$1047

West Camden Mobile File

Collection: WEST CAMDEN

Dimensions: 17.5w × 18d × 23.5h

Standard Finish: Tahitian Pearl

Materials: Walnut Solids and Veneers

Highlight Striping: N/A

Conversion Varnish: +\$450

Weight: 91 / 91 lbs

Cube: 4.28

Apron Height: N/A

Contrasting Finishes or Paints: +\$262

Paint Match: +\$262

Finished in Tahitian Pearl with Black Steel finished hardware and scallop-carved drawer fronts. Features hidden casters with one standard top drawer and one bottom lateral file drawer with a hidden pencil drawer. Fits under the 8096-81 West Camden Writing Desk.

Country: CHINA Assembly Req: N

8096-MH — Price: \$2997

West Camden Master Chest

Collection: WEST CAMDEN

Dimensions: 72w × 20d × 38h

Standard Finish: Tahitian Pearl

Materials: Walnut, Metal Accents

Highlight Striping: N/A

Conversion Varnish: +\$450

Weight: 293 / 293 lbs

Cube: 31.66

Apron Height: N/A

Contrasting Finishes or Paints: +\$749

Paint Match: +\$749

Features nine drawers with Black Nickel hardware and Tahitian Pearl Finish. All drawers feature full extension and self-closing hardware. Also available in any Fairfield Finish M096-MH

Country: VIETNAM Assembly Req: N

Also Available:

M096-MH in Custom Finishes at \$3897

8096-QB-E — Price: \$3597

West Camden Queen Bed

Collection: WEST CAMDEN

Dimensions: 65w × 85.5d × 71h

Standard Finish: Tahitian Pearl

Materials: Walnut

Highlight Striping: N/A

Conversion Varnish: N/A

Weight: 330 / 330 lbs

Cube: 228.34

Apron Height: N/A

Contrasting Finishes or Paints: N/A

Paint Match: N/A

Married in 3343-Ecru fabric (Grade T, Cleaning Code S),Tahitian Pearl Finish. Available with fabric and finish options M096-QB

Country: VIETNAM Assembly Req: Y

Also Available:

M096-QB in Custom Options starting at \$4797

8096-QH-B — Price: \$3597

West Camden Queen Bed

Collection: WEST CAMDEN

Dimensions: 65w × 85.5d × 60h

Standard Finish: Tahitian Pearl

Materials: Walnut

Highlight Striping: N/A

Conversion Varnish: N/A

Weight: 300 / 300 lbs

Cube: 192.96

Apron Height: N/A

Contrasting Finishes or Paints: N/A

Paint Match: N/A

Married in 1158 Bisque leather (Grade 4),Tahitian Pearl Finish. Available with fabric and finish options M096-QH

Country: VIETNAM Assembly Req: Y

Also Available:

M096-QH in Custom Options starting at \$4797

8096-QH-E — Price: \$3297

West Camden Queen Bed

Collection: WEST CAMDEN

Dimensions: 65w × 85.5d × 60h

Standard Finish: Tahitian Pearl

Materials: Walnut

Highlight Striping: N/A

Conversion Varnish: N/A

Weight: 300 / 300 lbs

Cube: 192.96

Apron Height: N/A

Contrasting Finishes or Paints: N/A

Paint Match: N/A

Married in 3343-Ecru fabric (Grade T, Cleaning Code S),Tahitian Pearl Finish. Available with fabric and finish options M096-QH

Country: VIETNAM Assembly Req: Y

Also Available:

M096-QH in Custom Options starting at \$4797

Casegoods

8096-SB — Price: \$2247

West Camden Nightstand

Collection: WEST CAMDEN

Dimensions: 32w × 22d × 30h Weight: 119 / 119 lbs Cube: 12.22

Standard Finish: Tahitian Pearl Apron Height: N/A

Materials: Walnut, Metal Accents

Highlight Striping: N/A

Conversion Varnish: N/A

Contrasting Finishes or Paints: N/A

Paint Match: N/A

Features one drawer and one pull out tray with inset White Carrera stone top. Metal base and hardware in Black Steel and Tahitian Pearl Finish. All drawers feature full extension and self-closing hardware. Also available in any Fairfield Finish M096-SB

Country: VIETNAM Assembly Req: N

Also Available:

M096-SB in Custom Finishes at \$2697

8096-SC — Price: \$1947

West Camden Chest

Collection: WEST CAMDEN

Dimensions: 38w × 19d × 38h Weight: 172 / 172 lbs Cube: 15.87

Standard Finish: Tahitian Pearl Apron Height: N/A

Materials: Metal Accents, Walnut

Highlight Striping: N/A

Conversion Varnish: +\$450

Contrasting Finishes or Paints: +\$487

Paint Match: +\$487

Features three drawers with Black Steel hardware and Tahitian Pearl Finish. All drawers feature full extension and self-closing hardware. Also available in any Fairfield Finish M096-SC.

Country: VIETNAM Assembly Req: N

Also Available:

M096-SC in Custom Finishes at \$2787

8096-ST — Price: \$2397

West Camden Three Drawer Console

Collection: WEST CAMDEN

Dimensions: 72w × 16d × 34h Weight: 145 / 145 lbs Cube: 11.48

Standard Finish: Tahitian Pearl Apron Height: N/A

Materials: Walnut Solids and Veneers, Stone

Highlight Striping: N/A

Conversion Varnish: N/A

Contrasting Finishes or Paints: +\$599

Paint Match: +\$599

Features Three finger pull, soft close drawers and a White Carrara stone top in Tahitian Pearl Finish. Also available in any Monogram Finish as M096-ST

Country: CHINA Assembly Req: N

Also Available:

M096-ST in Custom Finishes at \$3747

8098-08 — Price: \$1587

East Camden Vanity Desk

Collection: EAST CAMDEN

Dimensions: 54.5w × 28.5d × 30h Weight: 79 / 79 lbs Cube: 8.12

Standard Finish: Pearl Apron Height: N/A

Materials: Metal, Poplar Solids & Veneers

Highlight Striping: N/A

Conversion Varnish: +\$450

Contrasting Finishes or Paints: +\$397

Paint Match: +\$397

Finished in Pearl with Antique Brass ferrules, one drawer, and a fluted apron.

Country: CHINA Assembly Req: Y

8098-13 — Price: \$2307

East Camden Round Cocktail Table

Collection: EAST CAMDEN

Dimensions: 44w × 44d × 18h Weight: 82 / 82 lbs Cube: 26.93

Standard Finish: Pearl Apron Height: N/A

Materials: Metal, Poplar Solids & Veneers

Highlight Striping: N/A

Conversion Varnish: +\$450

Contrasting Finishes or Paints: N/A

Paint Match: N/A

Antique Brass metal base and a wood top finished in Pearl with glass insert.

Country: CHINA Assembly Req: Y

8098-16 — Price: \$1647

East Camden Dining Table Base

Collection: EAST CAMDEN

Dimensions: 30w × 30d × 29.5h Weight: 65 / 65 lbs Cube: 18.66

Standard Finish: Pearl Apron Height: N/A

Materials: Metal, Poplar Solids & Veneers

Highlight Striping: N/A

Conversion Varnish: N/A

Contrasting Finishes or Paints: N/A

Paint Match: +\$412

Antique Brass metal. Pairs with GLAS-54, 54" Glass Top and GLAS-60, 60" Glass Top.

Country: CHINA Assembly Req: N

8098-17 — Price: \$3957

East Camden Sideboard

Collection: EAST CAMDEN

Dimensions: 74w × 19d × 36h Weight: 213 / 213 lbs Cube: 38.41

Standard Finish: Pearl Apron Height: N/A

Materials: Metal, Poplar Solids & Veneers

Highlight Striping: N/A

Conversion Varnish: +\$594

Contrasting Finishes or Paints: N/A

Paint Match: +\$989

Finished in Pearl with Antique Brass metal accents, rose gold mirrored door panels, and interior adjustable shelves.

Country: CHINA Assembly Req: N

8098-19 — Price: \$897

East Camden Round End Table

Collection: EAST CAMDEN

Dimensions: 22w × 22d × 24h Weight: 44 / 44 lbs Cube: 10.36

Standard Finish: Pearl Apron Height: N/A

Materials: Metal, Poplar Solids & Veneers

Highlight Striping: N/A

Conversion Varnish: +\$450

Contrasting Finishes or Paints: N/A

Paint Match: +\$224

Finished in Pearl with Antique Brass metal frame

Country: CHINA Assembly Req: N

Casegoods

8098-38 — Price: \$2127

East Camden Chest

Collection: EAST CAMDEN

Dimensions: 36w × 20d × 32h Weight: 112 / 112 lbs Cube: 18.27

Standard Finish: Pearl Apron Height: N/A

Materials: Metal, Poplar Solids & Veneers

Highlight Striping: N/A

Contrasting Finishes or Paints: +\$532

Conversion Varnish: +\$450

Paint Match: +\$532

Finished in Pearl with Antique Brass metal accents, and three self-closing drawers with scalloped-carved fronts. Also available in any Monogram Finish as M098-38.

Country: CHINA Assembly Req: Y

Also Available:

M098-38 in Custom Finishes at \$3537

8098-44 — Price: \$3597

East Camden Dining Table

Collection: EAST CAMDEN

Dimensions: 60w × 60d × 32h Weight: 238 / 238 lbs Cube: 36.6

Standard Finish: Pearl Apron Height: N/A

Materials: Poplar Solids & Veneers

Highlight Striping: N/A

Contrasting Finishes or Paints: N/A

Conversion Varnish: +\$540

Paint Match: +\$899

Features One 22" leaf. Finished in Pearl Finish

Country: CHINA Assembly Req: Y

8098-47 — Price: \$1557

East Camden Oval End Table

Collection: EAST CAMDEN

Dimensions: 28w × 18d × 25h Weight: 56 / 56 lbs Cube: 9.96

Standard Finish: Pearl Apron Height: N/A

Materials: Metal & Italian Marble

Highlight Striping: N/A

Contrasting Finishes or Paints: N/A

Conversion Varnish: N/A

Paint Match: N/A

Carrara marble top and an Antique Brass metal base.

Country: CHINA Assembly Req: N

8098-48 — Price: \$3777

East Camden Bar Cabinet

Collection: EAST CAMDEN

Dimensions: 41w × 21d × 40h Weight: 96 / 96 lbs Cube: 27.37

Standard Finish: Pearl Apron Height: N/A

Materials: Poplar Solids & Veneers

Highlight Striping: N/A

Contrasting Finishes or Paints: +\$944

Conversion Varnish: +\$567

Paint Match: +\$944

Finished in Pearl with an inset Carrara marble top, two doors, and Antique Brass metal accents and hardware. Interior includes one fixed shelf, antique brass gallery, stem ware holder, storage for six wine bottles, and 4 door bin shelves.

Country: CHINA Assembly Req: N

8098-60 — Price: \$1317

East Camden Dining Table Top

Collection: EAST CAMDEN

Dimensions: 60w × 60d × 2h Weight: 110 / 110 lbs Cube: 9.04

Standard Finish: Pearl Apron Height: N/A

Materials: Poplar Solids & Veneers

Highlight Striping: N/A

Contrasting Finishes or Paints: N/A

Conversion Varnish: +\$450

Paint Match: +\$329

60" round dining table top finished in Pearl. Pairs with 8098-TB East Camden Dining Base.

Country: CHINA Assembly Req: Y

8098-81 — Price: \$1947

East Camden Writing Desk

Collection: EAST CAMDEN

Dimensions: 58w × 30d × 30h Weight: 141 / 141 lbs Cube: 11.9

Standard Finish: Pearl Apron Height: 29

Materials: Poplar Solids & Veneers

Highlight Striping: N/A

Contrasting Finishes or Paints: +\$487

Conversion Varnish: +\$450

Paint Match: +\$487

Finished in Pearl with Antique Brass metal accents and three soft-close drawers. Sized to pair with 8098-MF East Camden Mobile File.

Country: CHINA Assembly Req: Y

8098-82 — Price: \$3897

East Camden Credenza

Collection: EAST CAMDEN

Dimensions: 78w × 20d × 34h Weight: 293 / 293 lbs Cube: 39.21

Standard Finish: Pearl Apron Height: N/A

Materials: Walnut Solids and Veneers

Highlight Striping: +\$450

Contrasting Finishes or Paints: +\$974

Conversion Varnish: +\$585

Paint Match: +\$974

Features Four doors with an adjustable shelf behind each door. Antique Brass hardware

Country: CHINA Assembly Req: N

8098-83 — Price: \$2967

East Camden Deck

Collection: EAST CAMDEN

Dimensions: 45.5w × 14.25d × 45.75h Weight: 140 / 140 lbs Cube: 25.28

Standard Finish: Pearl Apron Height: N/A

Materials: Poplar Solids & Veneers, Antique Metal

Highlight Striping: N/A

Contrasting Finishes or Paints: N/A

Conversion Varnish: +\$450

Paint Match: +\$742

Finished in Pearl with oval, Antique Brass metal accents on the end panels and three-way adjustable touch lighting with three adjustable glass shelves.

Country: CHINA Assembly Req: Y

Casegoods

8098-84 — Price: \$3297

East Camden Lateral File

Collection: EAST CAMDEN

Dimensions: 47.5w × 20d × 33h Weight: 200 / 200 lbs Cube: 25.19

Standard Finish: Pearl Apron Height: 3.87

Materials: Poplar Solids & Veneers, Antique Metal

Highlight Striping: N/A

Contrasting Finishes or Paints: +\$824

Conversion Varnish: +\$495

Paint Match: +\$824

Finished in Pearl with Antique Brass hardware and scallop-carved drawer and door fronts. Two doors with interior storage housing adjustable shelves, standard outlet with a dual USB port, and cord exit holes. Two bottom lateral file drawers. Use alone or pair with 8098-83, East Camden Deck.

Country: CHINA Assembly Req: N

8098-86 — Price: \$2037

East Camden Center Hall Table

Collection: EAST CAMDEN

Dimensions: 38w × 38d × 30h Weight: 133 / 133 lbs Cube: 0

Standard Finish: Pearl Apron Height: N/A

Materials: Poplar Solids & Veneers

Highlight Striping: N/A

Contrasting Finishes or Paints: N/A

Conversion Varnish: +\$450

Paint Match: N/A

Finished in Pearl with Antique Brass metal accents Pairs with 8098-86-B, East Camden Base.

Country: CHINA Assembly Req: Y

8098-88 — Price: \$747

East Camden Drink Table

Collection: EAST CAMDEN

Dimensions: 18w × 18d × 26h Weight: 18 / 18 lbs Cube: 6.71

Standard Finish: Antique Brass Apron Height: N/A

Materials: Metal & Glass

Highlight Striping: N/A

Contrasting Finishes or Paints: N/A

Conversion Varnish: N/A

Paint Match: N/A

Antique Brass metal base and an acid-etched mirrored top.

Country: CHINA Assembly Req: Y

8098-93 — Price: \$1047

East Camden Rectangular Cocktail Table

Collection: EAST CAMDEN

Dimensions: 42w × 20d × 18h Weight: 43 / 43 lbs Cube: 4.68

Standard Finish: Pearl Apron Height: N/A

Materials: Metal, Poplar Solids & Veneers

Highlight Striping: N/A

Contrasting Finishes or Paints: N/A

Conversion Varnish: +\$450

Paint Match: +\$262

Tray top with Antique Brass metal base.

Country: CHINA Assembly Req: N

8098-94 — Price: \$627

East Camden Drink Table

Collection: EAST CAMDEN

Dimensions: 14w × 14d × 22h Weight: 23 / 23 lbs Cube: 1.61

Standard Finish: Pearl Apron Height: N/A

Materials: Metal, Poplar Solids & Veneers

Highlight Striping: N/A

Contrasting Finishes or Paints: N/A

Conversion Varnish: +\$450

Paint Match: +\$157

Tray top with Antique Brass metal base.

Country: CHINA Assembly Req: N

8098-96 — Price: \$3597

East Camden Credenza

Collection: EAST CAMDEN

Dimensions: 72w × 20d × 34h Weight: 256 / 256 lbs Cube: 28.33

Standard Finish: Pearl Apron Height: N/A

Materials: Metal, Poplar Solids & Veneers

Highlight Striping: +\$450

Contrasting Finishes or Paints: +\$899

Conversion Varnish: +\$540

Paint Match: +\$899

Features two doors with two interior adjustable shelves. Cord exit holes. Finished in Pearl with metal base in Antique Brass

Country: CHINA Assembly Req: N

8098-98 — Price: \$1917

East Camden Lamp Table

Collection: EAST CAMDEN

Dimensions: 28w × 22d × 24h Weight: 58 / 58 lbs Cube: 11.59

Standard Finish: Pearl Apron Height: N/A

Materials: Metal, Carrara Marble, & Glass

Highlight Striping: N/A

Contrasting Finishes or Paints: N/A

Conversion Varnish: N/A

Paint Match: N/A

Finished in Pearl with Antique Brass accents, Carrara marble top, and one fixed glass shelf.

Country: CHINA Assembly Req: Y

8098-99 — Price: \$2577

East Camden Console Table

Collection: EAST CAMDEN

Dimensions: 72w × 18d × 36h Weight: 119 / 119 lbs Cube: 14.75

Standard Finish: Pearl Apron Height: N/A

Materials: Metal, Carrara Marble, Poplar Solids & Veneers

Highlight Striping: N/A

Contrasting Finishes or Paints: N/A

Conversion Varnish: +\$450

Paint Match: +\$644

Finished in Pearl with Antique Brass metal base, curved scalloped apron, and Carrara marble top.

Country: CHINA Assembly Req: Y

Casegoods

8098-AD — Price: \$2697

East Camden Writing Desk

Collection: EAST CAMDEN

Dimensions: 58w × 28d × 30h Weight: 172 / 172 lbs Cube: 21.62

Standard Finish: Pearl Apron Height: N/A

Materials: Metal, Poplar Solids & Veneers

Highlight Striping: N/A

Contrasting Finishes or Paints: +\$674

Conversion Varnish: +\$450

Paint Match: +\$674

Features four soft close drawers. One pencil tray and hidden storage compartment. Finished in Pearl with Antique Brass accents.

Country: CHINA Assembly Req: Y

8098-AT — Price: \$1077

East Camden Accent Table

Collection: EAST CAMDEN

Dimensions: 17w × 17d × 22h Weight: 29 / 29 lbs Cube: 5.23

Standard Finish: Antique Brass Apron Height: N/A

Materials: Metal & Carrara Marble

Highlight Striping: N/A

Contrasting Finishes or Paints: N/A

Conversion Varnish: N/A

Paint Match: N/A

Features a Carrara marble top with an Antique Brass metal base.

Country: CHINA Assembly Req: N

8098-BS — Price: \$1887

East Camden Nightstand

Collection: EAST CAMDEN

Dimensions: 36w × 20d × 33.2h Weight: 157 / 157 lbs Cube: 13.83

Standard Finish: Pearl Apron Height: N/A

Materials: Metal Accents, Poplar Solids and Veneers

Highlight Striping: N/A

Contrasting Finishes or Paints: +\$472

Conversion Varnish: +\$450

Paint Match: +\$472

Features one drawer with Antique Brass hardware and Pearl Finish. All drawers feature full extension and self-closing hardware.

Country: VIETNAM Assembly Req: N

8098-CH — Price: \$2547

East Camden Chest

Collection: EAST CAMDEN

Dimensions: 44w × 19d × 36h Weight: 132 / 132 lbs Cube: 22.59

Standard Finish: Pearl Apron Height: N/A

Materials: Poplar Solids & Veneers

Highlight Striping: N/A

Contrasting Finishes or Paints: +\$637

Conversion Varnish: +\$450

Paint Match: +\$637

Finished in Pearl with Antique Brass accents and three drawers with fluted fronts and self-closing drawer guides.

Country: CHINA Assembly Req: Y

8098-CS — Price: \$927

East Camden Chairside Table

Collection: EAST CAMDEN

Dimensions: 16w × 28d × 24h Weight: 46 / 46 lbs Cube: 8.95

Standard Finish: Pearl Apron Height: N/A

Materials: Poplar Solids & Veneers

Highlight Striping: N/A

Contrasting Finishes or Paints: N/A

Conversion Varnish: +\$450

Paint Match: +\$232

Finished in Pearl with one pull-out shelf and two fixed shelves.

Country: CHINA Assembly Req: N

8098-CT — Price: \$1437

East Camden Round Cocktail Table

Collection: EAST CAMDEN

Dimensions: 44w × 44d × 19h Weight: 81 / 81 lbs Cube: 8.22

Standard Finish: Pearl Apron Height: N/A

Materials: Metal, Poplar Solids & Veneers

Highlight Striping: N/A

Contrasting Finishes or Paints: N/A

Conversion Varnish: +\$450

Paint Match: +\$359

Antique Brass metal

Country: CHINA Assembly Req: N

8098-DC — Price: \$2847

East Camden Chest

Collection: EAST CAMDEN

Dimensions: 60w × 20d × 38h Weight: 271 / 271 lbs Cube: 26.38

Standard Finish: Pearl Apron Height: N/A

Materials: Metal Accents, Poplar Solids and Veneers

Highlight Striping: N/A

Contrasting Finishes or Paints: +\$712

Conversion Varnish: +\$450

Paint Match: +\$712

Features six drawers with Antique Brass hardware and Pearl Finish. All drawers feature full extension and self-closing hardware.

Country: VIETNAM Assembly Req: N

8098-DK — Price: \$1947

East Camden Desk

Collection: EAST CAMDEN

Dimensions: 42w × 22d × 30h Weight: 79 / 79 lbs Cube: 16.04

Standard Finish: Pearl Apron Height: N/A

Materials: Metal Accents, Poplar Solids and Veneers

Highlight Striping: N/A

Contrasting Finishes or Paints: +\$487

Conversion Varnish: +\$450

Paint Match: +\$487

Features one drawer with Antique Brass hardware and Pearl Finish. All drawers feature full extension and self-closing hardware.

Country: VIETNAM Assembly Req: N

Casegoods

8098-DT — Price: \$4317

East Camden Scalloped Dining Table

Collection: EAST CAMDEN

Dimensions: 72w × 72d × 30h Weight: 234 / 234 lbs Cube: 37.13

Standard Finish: Pearl Apron Height: N/A

Materials: Poplar Solids & Veneers

Highlight Striping: N/A

Contrasting Finishes or Paints: N/A

Conversion Varnish: +\$648

Paint Match: +\$1079

72" round dining table top finished in Pearl. Consist of 8098-DT-B (Base) and 8098-DT-T (Top)

Country: CHINA Assembly Req: Y

8098-ET — Price: \$897

East Camden End Table

Collection: EAST CAMDEN

Dimensions: 22w × 22d × 24h Weight: 35 / 35 lbs Cube: 9.74

Standard Finish: Pearl Apron Height: N/A

Materials: Metal, Poplar Solids & Veneers

Highlight Striping: N/A

Contrasting Finishes or Paints: N/A

Conversion Varnish: +\$450

Paint Match: +\$224

Antique Brass metal

Country: CHINA Assembly Req: N

8098-HT — Price: \$987

East Camden Console Table

Collection: EAST CAMDEN

Dimensions: 46w × 14d × 34h Weight: 33 / 33 lbs Cube: 5.3

Standard Finish: Pearl Apron Height: N/A

Materials: Poplar Solids & Veneers

Highlight Striping: N/A

Contrasting Finishes or Paints: N/A

Conversion Varnish: +\$450

Paint Match: +\$247

Antique Brass metal

Country: CHINA Assembly Req: N

8098-KB-I — Price: \$3747

East Camden King Bed

Collection: EAST CAMDEN

Dimensions: 81w × 85.5d × 71h Weight: 108 / 108 lbs Cube: 284.55

Standard Finish: Pearl Apron Height: N/A

Materials: Metal Accents, Poplar Solids and Veneers

Highlight Striping: N/A

Contrasting Finishes or Paints: N/A

Conversion Varnish: N/A

Paint Match: N/A

Married in 3343-75 Ivory fabric and Pearl wood finish.

Country: VIETNAM Assembly Req: Y

8098-MF — Price: \$1137

East Camden Mobile File

Collection: EAST CAMDEN

Dimensions: 17.5w × 18d × 23.5h Weight: 91 / 91 lbs Cube: 6.44

Standard Finish: Pearl Apron Height: 2.25

Materials: Poplar Solids & Veneers

Highlight Striping: N/A

Contrasting Finishes or Paints: +\$284

Conversion Varnish: +\$450

Paint Match: +\$284

Finished in Pearl with Antique Brass hardware and scallop-carved drawer fronts. Features hidden casters with one standard top drawer and one bottom lateral file drawer with a hidden pencil drawer. Fits under the 8098-81 East Camden Writing Desk.

Country: CHINA Assembly Req: N

8098-MH — Price: \$2997

East Camden Chest

Collection: EAST CAMDEN

Dimensions: 72w × 20d × 38h Weight: 293 / 293 lbs Cube: 31.66

Standard Finish: Pearl Apron Height: N/A

Materials: Metal Accents, Poplar Solids and Veneers

Highlight Striping: N/A

Contrasting Finishes or Paints: +\$749

Conversion Varnish: +\$450

Paint Match: +\$749

Features nine drawers with Antique Brass hardware and Pearl Finish. All drawers feature full extension and self-closing hardware.

Country: VIETNAM Assembly Req: N

8098-QB-I — Price: \$3597

East Camden Queen Bed

Collection: EAST CAMDEN

Dimensions: 65w × 85.5d × 71h Weight: 98 / 98 lbs Cube: 228.34

Standard Finish: Pearl Apron Height: N/A

Materials: Metal Accents, Poplar Solids and Veneers

Highlight Striping: N/A

Contrasting Finishes or Paints: N/A

Conversion Varnish: N/A

Paint Match: N/A

Married in 3343-75 Ivory fabric and Pearl wood finish.

Country: VIETNAM Assembly Req: Y

8098-SB — Price: \$2247

East Camden Nightstand

Collection: EAST CAMDEN

Dimensions: 32w × 22d × 30h Weight: 119 / 119 lbs Cube: 12.22

Standard Finish: Pearl Apron Height: N/A

Materials: Metal Accents, Poplar Solids and Veneers

Highlight Striping: N/A

Contrasting Finishes or Paints: +\$562

Conversion Varnish: +\$450

Paint Match: +\$562

Features one drawer and one pull out tray. Metal base and hardware in Antique Brass finish. Pearl Finish. All drawers feature full extension and self-closing hardware.

Country: VIETNAM Assembly Req: N

Casegoods

8098-SC — Price: \$1947

East Camden Chest

Collection: EAST CAMDEN

Dimensions: 38w × 19d × 38h Weight: 172 / 172 lbs Cube: 15.87

Standard Finish: Pearl Apron Height: N/A

Materials: Metal Accents, Poplar Solids and Veneers

Highlight Striping: N/A

Contrasting Finishes or Paints: +\$487

Conversion Varnish: +\$450

Paint Match: +\$487

Features three drawers with Antique Brass hardware and Pearl Finish. All drawers feature full extension and self-closing hardware.

Country: VIETNAM Assembly Req: N

8098-ST — Price: \$2397

East Camden Three Drawer Console

Collection: EAST CAMDEN

Dimensions: 72w × 16d × 34h Weight: 160 / 160 lbs Cube: 22.66

Standard Finish: Pearl Apron Height: N/A

Materials: Poplar Solids & Veneers, Stone

Highlight Striping: N/A

Contrasting Finishes or Paints: +\$599

Conversion Varnish: N/A

Paint Match: +\$599

Features Three finger pull, soft close drawers and a White Carrara stone top in Pearl Finish.

Country: CHINA Assembly Req: N

8098-TB — Price: \$1587

East Camden Dining Table Base

Collection: EAST CAMDEN

Dimensions: 28w × 28d × 28h Weight: 42 / 42 lbs Cube: 16.54

Standard Finish: Antique Brass Apron Height: N/A

Materials: Metal Base

Highlight Striping: N/A

Contrasting Finishes or Paints: N/A

Conversion Varnish: N/A

Paint Match: +\$397

Metal base finished in Antique Brass. Pairs with 8098-60 East Camden 60" Dining Table Top, GLAS-54 54" Glass Top and GLAS-60 60" Glass Top.

Country: CHINA Assembly Req: Y

8099-88 — Price: \$747

Tribeca Drink Table

Collection: TRIBECA

Dimensions: 16w × 16d × 20h Weight: 37 / 37 lbs Cube: 4.15

Standard Finish: Hudson Apron Height: N/A

Materials: Hand Distressed Oak Solids & Veneers

Highlight Striping: N/A

Contrasting Finishes or Paints: N/A

Conversion Varnish: +\$450

Paint Match: N/A

Forged metal base with a wood top finished in Hudson.

Country: CHINA Assembly Req: N

8099-AT — Price: \$1977

Tribeca Accent Table

Collection: TRIBECA

Dimensions: 26w × 26d × 24h Weight: 56 / 56 lbs Cube: 12.69

Standard Finish: Hudson Apron Height: N/A

Materials: Hand Distressed Oak Solids & Veneers

Highlight Striping: N/A

Contrasting Finishes or Paints: N/A

Conversion Varnish: +\$450

Paint Match: N/A

Finished in Hudson with a forged metal base. Features a flip-top with hidden a storage beneath.

Country: CHINA Assembly Req: N

8102-48 — Price: \$2847

Temperate Grove Bar Cart

Collection: TEMPERATE GROVE

Dimensions: 34w × 23d × 34h Weight: 63 / 63 lbs Cube: 18.5

Standard Finish: Sanibel Apron Height: N/A

Materials: White Oak Solids & Veener. Raffia accents

Highlight Striping: N/A

Contrasting Finishes or Paints: N/A

Conversion Varnish: +\$450

Paint Match: +\$712

Finished in Sanibel with glass shelves and Brushed Brass casters, hardware, and accents.

Country: CHINA Assembly Req: Y

8102-85 — Price: \$5127

Temperate Grove Etageré

Collection: TEMPERATE GROVE

Dimensions: 32w × 15d × 80h Weight: 200 / 200 lbs Cube: 39.11

Standard Finish: Sanibel Apron Height: N/A

Materials: White Oak Solids & Veener. Raffia accents

Highlight Striping: N/A

Contrasting Finishes or Paints: N/A

Conversion Varnish: +\$769

Paint Match: +\$1282

Finished in Sanibel with Brushed Brass hardware and accents. Features two doors, one drawer, one adjustable shelf, and three glass shelves.

Country: CHINA Assembly Req: Y

8102-93 — Price: \$3057

Temperate Grove Cocktail Table

Collection: TEMPERATE GROVE

Dimensions: 54w × 30d × 20h Weight: 132 / 132 lbs Cube: 27.15

Standard Finish: Sanibel Apron Height: N/A

Materials: White Oak Solids & Veener. Raffia accents

Highlight Striping: N/A

Contrasting Finishes or Paints: N/A

Conversion Varnish: +\$459

Paint Match: +\$764

Finished in Sanibel with Brushed Brass hardware and accents, glass top, and raffia shelf.

Country: CHINA Assembly Req: Y

Casegoods

8102-94 — Price: \$1437

Temperate Grove End Table

Collection: TEMPERATE GROVE

Dimensions: 24w × 24d × 24h Weight: 40 / 40 lbs Cube: 11.17

Standard Finish: Sanibel Apron Height: N/A

Materials: White Oak Solids & Veener. Raffia accents

Highlight Striping: N/A

Contrasting Finishes or Paints: N/A

Conversion Varnish: +\$450

Paint Match: +\$359

Finished in Sanibel with Brushed Brass hardware and accents, glass top, and raffia shelf.

Country: CHINA Assembly Req: Y

8102-96 — Price: \$4257

Temperate Grove Console Table

Collection: TEMPERATE GROVE

Dimensions: 70w × 14d × 36h Weight: 123 / 123 lbs Cube: 29.44

Standard Finish: Sanibel Apron Height: N/A

Materials: White Oak Solids & Veener. Raffia accents

Highlight Striping: N/A

Contrasting Finishes or Paints: N/A

Conversion Varnish: +\$639

Paint Match: +\$1064

Finished in Sanibel with Brushed Brass hardware and accents, glass top, and raffia shelves.

Country: CHINA Assembly Req: Y

8102-CH — Price: \$3837

Temperate Grove Chest

Collection: TEMPERATE GROVE

Dimensions: 42w × 20d × 34h Weight: 165 / 165 lbs Cube: 22.81

Standard Finish: Sanibel Apron Height: N/A

Materials: White Oak Solids & Veener. Raffia accents

Highlight Striping: N/A

Contrasting Finishes or Paints: N/A

Conversion Varnish: +\$576

Paint Match: +\$959

Finished in Sanibel with Brushed Brass hardware and accents and a marble top.

Country: CHINA Assembly Req: N

8104-90 — Price: \$717

Boone Forge Lamp Table

Collection: BOONE FORGE

Dimensions: 20w × 14d × 27h Weight: 15 / 15 lbs Cube: 6.54

Standard Finish: Weathered Pecan Apron Height: N/A

Materials: Cold Weather, Russian Pine Solids & Veneers

Highlight Striping: N/A

Contrasting Finishes or Paints: N/A

Conversion Varnish: +\$450

Paint Match: N/A

Hand worn and distressed in Weathered Pecan finish with hand forged steel frame.

Country: CHINA Assembly Req: N

8104-BT — Price: \$2007

Boone Forge Counter Height Table

Collection: BOONE FORGE

Dimensions: 42w × 42d × 36h Weight: 90 / 90 lbs Cube: 47.46

Standard Finish: Weathered Pecan Apron Height: N/A

Materials: Cold Weather, Russian Pine Solids & Veneers

Highlight Striping: N/A

Contrasting Finishes or Paints: N/A

Conversion Varnish: +\$450

Paint Match: +\$502

Hand worn and distressed in Weathered Pecan finish with hand forged steel accents and two fixed shelves.

Country: CHINA Assembly Req: N

8104-CH — Price: \$3087

Boone Forge Sideboard

Collection:

Dimensions: 0w × 0d × 0h Weight: 260 / 260 lbs Cube: 53.3

Standard Finish: Weathered Pecan Apron Height: N/A

Materials:

Highlight Striping: N/A

Contrasting Finishes or Paints: N/A

Conversion Varnish: +\$463

Paint Match: +\$772

Country: CHINA Assembly Req: N

8105-15 — Price: \$2307

Belmont Round Dining Table

Collection: BELMONT

Dimensions: 48w × 48d × 30h Weight: 120 / 120 lbs Cube: 15.2

Standard Finish: Sable Apron Height: 26

Materials: Elm and Birch Solids & Veneers

Highlight Striping: N/A

Contrasting Finishes or Paints: N/A

Conversion Varnish: +\$450

Paint Match: +\$577

Finished in Sable.

Country: CHINA Assembly Req: Y

8105-47 — Price: \$1137

Belmont Oval End Table

Collection: BELMONT

Dimensions: 26w × 22d × 25h Weight: 25 / 25 lbs Cube: 11

Standard Finish: Sable Apron Height: N/A

Materials: Elm, Birch Solids & Veneers

Highlight Striping: N/A

Contrasting Finishes or Paints: N/A

Conversion Varnish: +\$450

Paint Match: +\$284

Finished in Sable with one fixed shelf.

Country: CHINA Assembly Req: N

Casegoods

8105-86 — Price: \$1257

Belmont Entry Table

Collection: BELMONT

Dimensions: 36w × 36d × 30h Weight: 47 / 47 lbs Cube: 5.96

Standard Finish: Sable Apron Height: N/A

Materials: Elm, Birch Solids & Veneers

Highlight Striping: N/A

Contrasting Finishes or Paints: N/A

Conversion Varnish: +\$450

Paint Match: +\$314

Finished in Sable with polished stainless steel accents. Consists of 8105-86-B (Base) and 8105-86-T (Top)

Country: CHINA Assembly Req: Y

8105-93 — Price: \$1527

Belmont Rectangular Cocktail Table

Collection: BELMONT

Dimensions: 48w × 32d × 19h Weight: 65 / 65 lbs Cube: 8.11

Standard Finish: Sable Apron Height: N/A

Materials: Elm, Birch Solids & Veneers

Highlight Striping: N/A

Contrasting Finishes or Paints: N/A

Conversion Varnish: +\$450

Paint Match: +\$382

Finished in Sable with one fixed shelf.

Country: CHINA Assembly Req: Y

8105-94 — Price: \$1107

Belmont Square End Table

Collection: BELMONT

Dimensions: 24w × 24d × 26h Weight: 25 / 25 lbs Cube: 11.37

Standard Finish: Sable Apron Height: N/A

Materials: Elm, Birch Solids & Veneers

Highlight Striping: N/A

Contrasting Finishes or Paints: N/A

Conversion Varnish: +\$450

Paint Match: +\$277

Finished in Sable.

Country: CHINA Assembly Req: N

8105-99 — Price: \$1497

Belmont Sofa Table

Collection: BELMONT

Dimensions: 60w × 17d × 29h Weight: 55 / 55 lbs Cube: 6.24

Standard Finish: Sable Apron Height: N/A

Materials: Elm, Birch Solids & Veneers

Highlight Striping: N/A

Contrasting Finishes or Paints: N/A

Conversion Varnish: +\$450

Paint Match: +\$374

Finished in Sable.

Country: CHINA Assembly Req: Y

8105-AC — Price: \$2547

Belmont Accent Chest

Collection: BELMONT

Dimensions: 48w × 18d × 36h Weight: 115 / 115 lbs Cube: 23.84

Standard Finish: Sable Apron Height: N/A

Materials: Elm, Birch Solids & Veneers

Highlight Striping: N/A

Contrasting Finishes or Paints: N/A

Conversion Varnish: +\$450

Paint Match: N/A

Finished in Sable with three drawers and silver leaf inlay under drawer front carvings.

Country: CHINA Assembly Req: N

8105-AT — Price: \$897

Belmont Accent Table

Collection: BELMONT

Dimensions: 26w × 26d × 26h Weight: 25 / 25 lbs Cube: 3.4

Standard Finish: Sable Apron Height: N/A

Materials: Elm, Birch Solids & Veneers

Highlight Striping: N/A

Contrasting Finishes or Paints: N/A

Conversion Varnish: +\$450

Paint Match: +\$224

Finished in Sable with one fixed shelf.

Country: CHINA Assembly Req: Y

8105-CS — Price: \$1467

Belmont Chairside Table

Collection: BELMONT

Dimensions: 26w × 26d × 25h Weight: 50 / 50 lbs Cube: 12.93

Standard Finish: Sable Apron Height: N/A

Materials: Elm, Birch Solids & Veneers

Highlight Striping: N/A

Contrasting Finishes or Paints: N/A

Conversion Varnish: +\$450

Paint Match: +\$367

Finished in Sable.

Country: CHINA Assembly Req: N

8105-ET — Price: \$987

Belmont Round End Table

Collection: BELMONT

Dimensions: 22w × 22d × 26h Weight: 15 / 15 lbs Cube: 9.52

Standard Finish: Sable Apron Height: N/A

Materials: Elm, Birch Solids & Veneers

Highlight Striping: N/A

Contrasting Finishes or Paints: N/A

Conversion Varnish: +\$450

Paint Match: +\$247

Finished in Sable with one fixed shelf.

Country: CHINA Assembly Req: N

Casegoods

8106-19 — Price: \$1287

Edgewood Lamp Table

Collection: EDGEWOOD

Dimensions: 26w × 26d × 26h Weight: 40 / 40 lbs Cube: 13.15

Standard Finish: Graystone Apron Height: N/A

Materials: Cold Weather, Russian Pine Solids and Veneers

Highlight Striping: N/A

Contrasting Finishes or Paints: N/A

Conversion Varnish: +\$450

Paint Match: +\$322

Finished in Graystone with a hand-forged, textured finish metal base.

Country: CHINA Assembly Req: N

8106-ET — Price: \$1377

Edgewood End Table

Collection: EDGEWOOD

Dimensions: 25.5w × 23d × 26h Weight: 65 / 65 lbs Cube: 11.88

Standard Finish: Graystone Apron Height: N/A

Materials: Cold Weather, Russian Pine Solids and Veneers

Highlight Striping: N/A

Contrasting Finishes or Paints: N/A

Conversion Varnish: +\$450

Paint Match: +\$344

Finished in Graystone with hand-forged, textured finish metal and two fixed shelves.

Country: CHINA Assembly Req: N

8108-17 — Price: \$3147

Aspect Credenza

Collection: ASPECT

Dimensions: 72w × 18d × 35h Weight: 202 / 202 lbs Cube: 35.64

Standard Finish: Dune Apron Height: N/A

Materials: Mango Solids

Highlight Striping: N/A

Contrasting Finishes or Paints: +\$787

Conversion Varnish: +\$472

Paint Match: +\$787

Finished in Dune with a metal base and four doors, interior adjustable shelves and cord exit holes.

Country: INDIA Assembly Req: N

8108-96 — Price: \$3147

Aspect Credenza

Collection: ASPECT

Dimensions: 72w × 18d × 34h Weight: 172 / 172 lbs Cube: 35.32

Standard Finish: Dune Apron Height: N/A

Materials: Mango Solids

Highlight Striping: N/A

Contrasting Finishes or Paints: +\$787

Conversion Varnish: +\$472

Paint Match: +\$787

Finished in Dune with a metal base and four doors, interior adjustable shelves and cord exit holes.

Country: INDIA Assembly Req: N

8109-19 — Price: \$1227

Churchill Lamp Table

Collection: CHURCHILL

Dimensions: 26w × 26d × 26h Weight: 45 / 45 lbs Cube: 13.15

Standard Finish: Tobacco Apron Height: N/A

Materials: Cold Weather, Russian Pine Solids & Veneers

Highlight Striping: N/A

Contrasting Finishes or Paints: N/A

Conversion Varnish: +\$450

Paint Match: +\$307

Tobacco finished wood top with a hand-forged, textured finish metal base.

Country: CHINA Assembly Req: N

8109-MC — Price: \$3357

Churchill Media Console

Collection: CHURCHILL

Dimensions: 63w × 20d × 32h Weight: 185 / 185 lbs Cube: 29.85

Standard Finish: Tobacco Apron Height: N/A

Materials: Cold Weather, Russian Pine Solids & Veneers

Highlight Striping: N/A

Contrasting Finishes or Paints: N/A

Conversion Varnish: +\$504

Paint Match: +\$839

Finished in Tobacco with three doors featuring a framed glass and metal overlay. One interior removable shelf behind each door.

Country: CHINA Assembly Req: N

8109-ST — Price: \$2547

Churchill Console

Collection: CHURCHILL

Dimensions: 66w × 17d × 34h Weight: 120 / 120 lbs Cube: 17.29

Standard Finish: Tobacco Apron Height: N/A

Materials: Cold Weather, Russian Pine Solids & Veneers

Highlight Striping: N/A

Contrasting Finishes or Paints: N/A

Conversion Varnish: +\$450

Paint Match: +\$637

Finished in Tobacco with three drawers and a fixed bottom shelf.

Country: CHINA Assembly Req: Y

8113-17 — Price: \$2127

Rustique Console Table

Collection: RUSTIQUE

Dimensions: 72w × 18d × 36h Weight: 96 / 96 lbs Cube: 10.55

Standard Finish: Rustique Apron Height: N/A

Materials: Quartered Elm, Ash Solids & Veneers

Highlight Striping: N/A

Contrasting Finishes or Paints: +\$532

Conversion Varnish: +\$450

Paint Match: +\$532

Features two drawers.

Country: CHINA Assembly Req: Y

Casegoods

8113-19 — Price: \$1077

Rustique Round End Table

Collection: RUSTIQUE

Dimensions: 26w × 25d × 24h Weight: 35 / 35 lbs Cube: 11.81

Standard Finish: Rustique Apron Height: N/A

Materials: Gun Metal & Wooden Top

Highlight Striping: N/A

Contrasting Finishes or Paints: N/A

Conversion Varnish: +\$450

Paint Match: +\$269

Rustique finish.

Country: CHINA Assembly Req: N

8113-43 — Price: \$3477

Rustique Dining Table

Collection: RUSTIQUE

Dimensions: 106w × 42d × 30.5h Weight: 231 / 231 lbs Cube: 24.77

Standard Finish: Rustique Apron Height: N/A

Materials: Quartered Elm, Ash Solids & Veneers

Highlight Striping: N/A

Contrasting Finishes or Paints: N/A

Conversion Varnish: +\$522

Paint Match: +\$869

Features two removable 12" leaves.

Country: CHINA Assembly Req: Y

8113-81 — Price: \$1947

Rustique Writing Desk

Collection: RUSTIQUE

Dimensions: 60w × 28d × 30h Weight: 108 / 108 lbs Cube: 10.17

Standard Finish: Rustique Apron Height: 26

Materials: Quartered Elm, Ash Solids & Veneers

Highlight Striping: N/A

Contrasting Finishes or Paints: N/A

Conversion Varnish: +\$450

Paint Match: +\$487

Rustique finish with one drawer.

Country: CHINA Assembly Req: Y

8113-84 — Price: \$3357

Rustique Lateral File

Collection: RUSTIQUE

Dimensions: 47w × 22d × 33h Weight: 191 / 191 lbs Cube: 27.24

Standard Finish: Rustique Apron Height: N/A

Materials: Quartered Elm, Ash Solids & Veneers

Highlight Striping: N/A

Contrasting Finishes or Paints: +\$839

Conversion Varnish: +\$504

Paint Match: +\$839

Two standard drawers and one lateral file drawer. Open storage area with a USB & Standard Outlet. Cord exit holes for equipment management.

Country: CHINA Assembly Req: Y

8113-96 — Price: \$1407

Rustique Console Table

Collection: RUSTIQUE

Dimensions: 60w × 12d × 35h Weight: 90 / 90 lbs Cube: 6.53

Standard Finish: Rustique Apron Height: N/A

Materials: Quartered Elm, Ash Solids & Veneers

Highlight Striping: N/A

Contrasting Finishes or Paints: N/A

Conversion Varnish: +\$450

Paint Match: +\$352

Two drawers and one fixed shelf

Country: CHINA Assembly Req: Y

8113-98 — Price: \$2247

Rustique Drum Table

Collection: RUSTIQUE

Dimensions: 28w × 28d × 24h Weight: 130 / 130 lbs Cube: 14.29

Standard Finish: Rustique Apron Height: N/A

Materials: Marble, Quartered Elm, Ash Solids & Veneers

Highlight Striping: N/A

Contrasting Finishes or Paints: N/A

Conversion Varnish: N/A

Paint Match: +\$562

Finished in Rustique with a Carrera marble top, one door, and on interior shelf.

Country: CHINA Assembly Req: N

8113-99 — Price: \$2247

Rustique Counter Height Sofa Table

Collection: RUSTIQUE

Dimensions: 68w × 18d × 36h Weight: 135 / 135 lbs Cube: 9.58

Standard Finish: Rustique Apron Height: N/A

Materials: Marble, Quartered Elm, Ash Solids & Veneers

Highlight Striping: N/A

Contrasting Finishes or Paints: +\$562

Conversion Varnish: N/A

Paint Match: +\$562

Finished in Rustique with a Carrera marble top. Designed with dual functionality, this sofa table is counter height with an open end to accommodate two counter stools.

Country: CHINA Assembly Req: Y

8113-BT — Price: \$1677

Rustique Counter Height Table

Collection: RUSTIQUE

Dimensions: 36w × 36d × 36h Weight: 60 / 60 lbs Cube: 14.42

Standard Finish: Rustique Apron Height: N/A

Materials: Quartered Elm, Ash Solids & Veneers

Highlight Striping: N/A

Contrasting Finishes or Paints: +\$419

Conversion Varnish: +\$450

Paint Match: +\$419

Finished in Rustique. Consists of 8113-BT-B (Base) and 8113-BT-T (Top)

Country: CHINA Assembly Req: Y

Casegoods

8113-ET — Price: \$1587

Rustique End Table

Collection: RUSTIQUE

Dimensions: 18w × 28d × 27h Weight: 75 / 75 lbs Cube: 10.89

Standard Finish: Rustique Apron Height: N/A

Materials: Marble, Quartered Elm, Ash Solids & Veneers

Highlight Striping: N/A Contrasting Finishes or Paints: N/A

Conversion Varnish: N/A Paint Match: +\$397

One fixed shelf with mable inset top.

Country: CHINA Assembly Req: N

8113-FT — Price: \$1707

Rustique Flip-Top Table

Collection: RUSTIQUE

Dimensions: 60w × 0d × 31h Weight: 90 / 90 lbs Cube: 8.02

Standard Finish: Rustique Apron Height: N/A

Materials: Quartered Elm, Ash Solids & Veneers

Highlight Striping: N/A Contrasting Finishes or Paints: N/A

Conversion Varnish: +\$450 Paint Match: +\$427

Country: CHINA Assembly Req: Y

8113-HT — Price: \$2307

Rustique Open Storage Console Table

Collection: RUSTIQUE

Dimensions: 72w × 16d × 36h Weight: 118 / 118 lbs Cube: 16.82

Standard Finish: Rustique Apron Height: N/A

Materials: Quartered Elm, Ash Solids & Veneers

Highlight Striping: N/A Contrasting Finishes or Paints: N/A

Conversion Varnish: +\$450 Paint Match: +\$577

Finished in Rustique with open storage and an X-frame metal base.

Country: CHINA Assembly Req: Y

8113-LD — Price: \$2277

Rustique Lateral File Deck

Collection: RUSTIQUE

Dimensions: 44.75w × 12.25d × 42h Weight: 80 / 80 lbs Cube: 18.95

Standard Finish: Rustique Apron Height: N/A

Materials: Quartered Elm, Ash Solids & Veneers

Highlight Striping: N/A Contrasting Finishes or Paints: +\$569

Conversion Varnish: +\$450 Paint Match: +\$569

Finished in Rustique with two inset glass shelves and adjustable LED lighting. Pairs with 8113-84 Rustique Lateral File, includes mending plates for attachment to the Lateral File.

Country: CHINA Assembly Req: Y

8113-MF — Price: \$1497

Rustique Mobile File

Collection: RUSTIQUE

Dimensions: 15.5w × 18d × 25.5h Weight: 91 / 91 lbs Cube: 7.69

Standard Finish: Rustique Apron Height: N/A

Materials: Quartered Elm, Ash Solids & Veneers

Highlight Striping: N/A Contrasting Finishes or Paints: +\$374

Conversion Varnish: +\$450 Paint Match: +\$374

Finished in Rustique with black metal hardware and hidden casters. Includes one standard top drawer and one bottom lateral file drawer with a hidden pencil drawer. Fits under the 8113-81 Rustique Writing Desk.

Country: CHINA Assembly Req: N

8113-RC — Price: \$2007

Rustique Cocktail Table

Collection: RUSTIQUE

Dimensions: 64w × 22d × 18h Weight: 150 / 150 lbs Cube: 19.56

Standard Finish: Rustique Apron Height: N/A

Materials: Quartered Elm, Ash Solids & Veneers

Highlight Striping: N/A Contrasting Finishes or Paints: N/A

Conversion Varnish: +\$450 Paint Match: +\$502

Country: CHINA Assembly Req: N

8113-TB — Price: \$1587

Rustique Table Base

Collection: RUSTIQUE

Dimensions: 26w × 26d × 27.5h Weight: 70 / 70 lbs Cube: 13.07

Standard Finish: Rustique Apron Height: N/A

Materials: Quartered Elm and Ash Solids and Veneers

Highlight Striping: N/A Contrasting Finishes or Paints: N/A

Conversion Varnish: N/A Paint Match: +\$397

Rustic Elegance with hand wire brushing, creates deep finish characteristics For use with 813R-48 and -60 Table Tops.

Country: CHINA Assembly Req: Y

8114-AT — Price: \$897

Tranquility Shores Accent Table

Collection: TRANQUILITY SHORES

Dimensions: 26w × 26d × 26h Weight: 25 / 25 lbs Cube: 3.4

Standard Finish: Tranquility Apron Height: N/A

Materials: Birch Solids & Veneers

Highlight Striping: N/A Contrasting Finishes or Paints: +\$224

Conversion Varnish: +\$450 Paint Match: +\$224

Features three European carved posts and one fixed shelf in Tranquility finish.

Country: CHINA Assembly Req: Y

Casegoods

8115-15 — Price: \$1977

Grandview Dining Table

Collection: GRANDVIEW

Dimensions: 48w × 48d × 30h Weight: 92 / 92 lbs Cube: 13.26

Standard Finish: Candlelight Apron Height: 27.5

Materials: Cherry solids & Veneers

Highlight Striping: N/A

Contrasting Finishes or Paints: N/A

Conversion Varnish: +\$450

Paint Match: +\$494

Split matched veneer insets and solid edge perimeters. Consists of 8115-15-T (Top) and 8115-15-B (Base).

Country: CHINA Assembly Req: Y

8115-47 — Price: \$987

Grandview Oval End Table

Collection: GRANDVIEW

Dimensions: 30w × 22d × 26.5h Weight: 45 / 45 lbs Cube: 5.48

Standard Finish: Candlelight Apron Height: N/A

Materials: Cherry solids & Veneers

Highlight Striping: N/A

Contrasting Finishes or Paints: N/A

Conversion Varnish: +\$450

Paint Match: +\$247

Finished in Candlelight with split matched veneer insets and solid edge perimeters. One drawer and one fixed shelf.

Country: CHINA Assembly Req: Y

8115-90 — Price: \$987

Grandview Chairside Table

Collection: GRANDVIEW

Dimensions: 28w × 28d × 27.5h Weight: 40 / 40 lbs Cube: 4.74

Standard Finish: Candlelight Apron Height: N/A

Materials: Cherry solids & Veneers

Highlight Striping: N/A

Contrasting Finishes or Paints: N/A

Conversion Varnish: +\$450

Paint Match: +\$247

Finished in Candlelight with split matched veneer insets and solid edge perimeters. Two fixed shelves.

Country: CHINA Assembly Req: Y

8115-99 — Price: \$1437

Grandview Sofa Table

Collection: GRANDVIEW

Dimensions: 56w × 18d × 31.25h Weight: 61 / 61 lbs Cube: 9.78

Standard Finish: Candlelight Apron Height: 27

Materials: Cherry solids & Veneers

Highlight Striping: N/A

Contrasting Finishes or Paints: N/A

Conversion Varnish: +\$450

Paint Match: +\$359

Split matched veneer insets and solid edge perimeters. Consists of 8115-99-T (Top) and 8115-99-B (Base).

Country: CHINA Assembly Req: Y

8116-95 — Price: \$1347

Park West End Table

Collection: PARK WEST

Dimensions: 22w × 26d × 28h Weight: 55 / 55 lbs Cube: 12.88

Standard Finish: Venezia Apron Height: N/A

Materials: Birch Solids with Book Matched Asian Cherry Veneers

Highlight Striping: N/A

Contrasting Finishes or Paints: +\$337

Conversion Varnish: +\$450

Paint Match: +\$337

Finished in Venezia with antique brass accents and hardware. One drawer and one fixed shelf.

Country: CHINA Assembly Req: N

8116-CH — Price: \$2367

Park West Chest

Collection: PARK WEST

Dimensions: 40w × 18d × 36h Weight: 90 / 90 lbs Cube: 20.61

Standard Finish: Venezia Apron Height: N/A

Materials: Birch Solids with Book Matched Asian Cherry Veneers

Highlight Striping: N/A

Contrasting Finishes or Paints: +\$592

Conversion Varnish: +\$450

Paint Match: +\$592

Inspired by parquet woodworking, the drawer fronts and top feature a diamond pattern design finished in Venezia. Three drawers with antique brass hardware.

Country: CHINA Assembly Req: N

8116-CS — Price: \$1887

Park West Chairside Table

Collection: PARK WEST

Dimensions: 22w × 22d × 26h Weight: 40 / 40 lbs Cube: 10.07

Standard Finish: Venezia Apron Height: N/A

Materials: Birch Solids with Book Matched Asian Cherry Veneers

Highlight Striping: N/A

Contrasting Finishes or Paints: N/A

Conversion Varnish: +\$450

Paint Match: +\$472

Antique brass base and wood top with decorative pattern finished in Venezia.

Country: CHINA Assembly Req: N

8119-16 — Price: \$1197

Dining Table Base

Collection: PROVENCE

Dimensions: 20w × 20d × 29h Weight: 136 / 136 lbs Cube: 6.71

Standard Finish: Sandstone Apron Height: 29

Materials: Red Oak Solids and Veneers

Highlight Striping: N/A

Contrasting Finishes or Paints: N/A

Conversion Varnish: N/A

Paint Match: N/A

Country: CHINA Assembly Req: Y

Casegoods

8119-17 — Price: \$3267

Provence Sideboard

Collection: PROVENCE

Dimensions: 60w × 15d × 41h Weight: 210 / 210 lbs Cube: 24.41

Standard Finish: Sandstone Apron Height: N/A

Materials: Marble, Select Oak Veneers & Solids

Highlight Striping: N/A

Contrasting Finishes or Paints: +\$817

Conversion Varnish: +\$490

Paint Match: +\$817

Finished in Sandstone with an inset marble top and brass accents. Three top drawers, three base level doors, and one adjustable shelf behind each door.

Country: CHINA Assembly Req: N

8119-19 — Price: \$1257

Provence Round End Table

Collection: PROVENCE

Dimensions: 24w × 24d × 26h Weight: 45 / 45 lbs Cube: 3.05

Standard Finish: Sandstone Apron Height: N/A

Materials: Marble, Select Oak Veneers & Solids

Highlight Striping: N/A

Contrasting Finishes or Paints: N/A

Conversion Varnish: N/A

Paint Match: +\$314

Finished in Sandstone with an inset marble top and brass accents.

Country: CHINA Assembly Req: Y

8119-88 — Price: \$987

Provence Drink Table

Collection: PROVENCE

Dimensions: 16w × 16d × 26h Weight: 25 / 25 lbs Cube: 1.89

Standard Finish: Sandstone Apron Height: N/A

Materials: Marble, Select Oak Veneers & Solids

Highlight Striping: N/A

Contrasting Finishes or Paints: N/A

Conversion Varnish: N/A

Paint Match: N/A

Finished in Sandstone with a marble top and brass accents.

Country: CHINA Assembly Req: Y

8119-CB — Price: \$1287

Counter Height Table Base

Collection: PROVENCE

Dimensions: 20w × 20d × 35h Weight: 136 / 136 lbs Cube: 8.1

Standard Finish: Sandstone Apron Height: 35

Materials: Red Oak Solids and Veneers

Highlight Striping: N/A

Contrasting Finishes or Paints: N/A

Conversion Varnish: N/A

Paint Match: N/A

Country: CHINA Assembly Req: Y

8120-15 — Price: \$2307

Manhattan Dining Table

Collection: MANHATTAN

Dimensions: 48w × 48d × 30h Weight: 95 / 95 lbs Cube: 26.48

Standard Finish: Manhattan Apron Height: 29.25

Materials: Adler solids & Cherry veneers

Highlight Striping: N/A

Contrasting Finishes or Paints: N/A

Conversion Varnish: +\$450

Paint Match: +\$577

Brushed nickel accents. Consists of 8120-15-T (Top) and 8120-15-B (Base).

Country: CHINA Assembly Req: Y

8120-94 — Price: \$1407

Manhattan Square End Table

Collection: MANHATTAN

Dimensions: 26w × 26d × 26h Weight: 55 / 55 lbs Cube: 13.16

Standard Finish: Manhattan Apron Height: N/A

Materials: Alder Solids & Cherry Veneers

Highlight Striping: N/A

Contrasting Finishes or Paints: +\$352

Conversion Varnish: +\$450

Paint Match: +\$352

Finished in Manhattan with Brushed Nickel hardware and two drawers.

Country: CHINA Assembly Req: N

8120-97 — Price: \$1647

Manhattan Console

Collection: MANHATTAN

Dimensions: 38w × 22d × 29h Weight: 95 / 95 lbs Cube: 18.56

Standard Finish: Manhattan Apron Height: N/A

Materials: Alder Solids & Cherry Veneers

Highlight Striping: N/A

Contrasting Finishes or Paints: +\$412

Conversion Varnish: +\$450

Paint Match: +\$412

Features two drawers, one fixed shelf, and one pull out shelf.

Country: CHINA Assembly Req: N

8120-98 — Price: \$1137

Manhattan Storage Lamp Table

Collection: MANHATTAN

Dimensions: 24w × 24d × 26h Weight: 60 / 60 lbs Cube: 11.78

Standard Finish: Manhattan Apron Height: N/A

Materials: Alder Solids & Cherry Veneers

Highlight Striping: N/A

Contrasting Finishes or Paints: +\$284

Conversion Varnish: +\$450

Paint Match: +\$284

Finished in Manhattan with Brushed Nickel hardware and two doors that open to a center storage area.

Country: CHINA Assembly Req: N

Casegoods

8123-17 — Price: \$2907

Harborside Sideboard

Collection: HARBORSIDE

Dimensions: 40w × 17d × 40h Weight: 123 / 123 lbs Cube: 19.42

Standard Finish: Tarnished Creme Apron Height: N/A

Materials: Birch Solids & Veneers

Highlight Striping: N/A

Contrasting Finishes or Paints: N/A

Conversion Varnish: +\$450

Paint Match: +\$727

Finished in Tarnished Creme with two doors and four adjustable interior shelves. Glass door panels feature an aged pewter metal grill.

Country: CHINA Assembly Req: N

8123-CS — Price: \$1047

Harborside Chairside Table

Collection: HARBORSIDE

Dimensions: 14.5w × 22d × 26.5h Weight: 35 / 35 lbs Cube: 7.21

Standard Finish: Tarnished Creme Apron Height: N/A

Materials: Birch Solids & Veneers

Highlight Striping: N/A

Contrasting Finishes or Paints: N/A

Conversion Varnish: +\$450

Paint Match: +\$262

Finished in Tarnished Creme with gallery moldings on the top and fixed shelf. One drawer.

Country: CHINA Assembly Req: N

8127-TB — Price: \$1557

Nottingham Cottage Table Base

Collection: NOTTINGTON COTTAGE

Dimensions: 26w × 26d × 27.5h Weight: 65 / 65 lbs Cube: 13.53

Standard Finish: Antique Parchment Apron Height: N/A

Materials: Birch Solids & Veneers

Highlight Striping: N/A

Contrasting Finishes or Paints: N/A

Conversion Varnish: +\$450

Paint Match: +\$389

Features a Neoclassical design influence with structured elements, softened with a distressed, Antique Parchment finish.

Country: CHINA Assembly Req: Y

8128-99 — Price: \$3297

Pashmina Console

Collection: SUNDRIES

Dimensions: 76w × 15d × 38h Weight: 74 / 74 lbs Cube: 25.06

Standard Finish: Apron Height: N/A

Materials: Metal Accents, Marble

Highlight Striping: N/A

Contrasting Finishes or Paints: N/A

Conversion Varnish: N/A

Paint Match: N/A

Morchana Marble Top with fretwork metal base

Country: INDIA Assembly Req: N

8133-88 — Price: \$747

St. Jerome Drink Table

Collection: ST. JEROME

Dimensions: 14.5w × 14.5d × 24h Weight: 20 / 20 lbs Cube: 5.25

Standard Finish: Aged Brass Apron Height: N/A

Materials: Alder Solids & Cherry Veneers

Highlight Striping: N/A

Contrasting Finishes or Paints: N/A

Conversion Varnish: +\$450

Paint Match: +\$187

Finished in a metallic, Aged Brass with one fixed shelf.

Country: CHINA Assembly Req: N

8134-13 — Price: \$1917

Origins Round Cocktail Table

Collection: ORIGINS

Dimensions: 44w × 44d × 19h Weight: 126 / 126 lbs Cube: 23.64

Standard Finish: Gold Leaf Apron Height: N/A

Materials: Metal & Carrara Marble

Highlight Striping: N/A

Contrasting Finishes or Paints: N/A

Conversion Varnish: N/A

Paint Match: N/A

Chiseled edge Carrara marble top with a Gold Leaf metal base.

Country: INDIA Assembly Req: Y

8134-17 — Price: \$2397

Origins Credenza

Collection: ORIGINS

Dimensions: 47w × 18d × 30h Weight: 90 / 90 lbs Cube: 27.82

Standard Finish: Gold Leaf Apron Height: N/A

Materials: Mango Solids

Highlight Striping: N/A

Contrasting Finishes or Paints: N/A

Conversion Varnish: +\$450

Paint Match: N/A

Mango Solid wood with dimensional doors covered in gold foil and a black metal base. One adjustable interior shelf behind each door.

Country: INDIA Assembly Req: N

8134-19 — Price: \$837

Origins Lamp Table

Collection: ORIGINS

Dimensions: 18w × 18d × 26h Weight: 45 / 45 lbs Cube: 6.78

Standard Finish: Gold Leaf Apron Height: N/A

Materials: Mango Solids

Highlight Striping: N/A

Contrasting Finishes or Paints: N/A

Conversion Varnish: N/A

Paint Match: N/A

Features Carrara marble with a chiseled edge.

Country: INDIA Assembly Req: Y

Casegoods

8134-48 — Price: \$1737

Origins Bar Cart

Collection: ORIGINS

Dimensions: 36w × 20d × 32h Weight: 171 / 171 lbs Cube: 21.94

Standard Finish: Gold Leaf Apron Height: N/A

Materials: Mango Solids

Highlight Striping: N/A

Contrasting Finishes or Paints: N/A

Conversion Varnish: N/A

Paint Match: N/A

Onyx marble. Consists of 8134-48-B (Base) and 8134-48-T (Top)

Country: INDIA Assembly Req: N

8134-ET — Price: \$1167

Origins End Table

Collection: ORIGINS

Dimensions: 24w × 24d × 24h Weight: 0 / 0 lbs Cube: 8

Standard Finish: Gold Leaf Apron Height: N/A

Materials: Carrera Marble and Metal

Highlight Striping: N/A

Contrasting Finishes or Paints: N/A

Conversion Varnish: N/A

Paint Match: N/A

Chiseled edge Carrara marble top with a Gold Leaf metal base. Consists of 8134-ET-T and 8134-ET-B, Origins End Table Top and Base.

Country: INDIA Assembly Req: N

8135-12 — Price: \$1437

Sundries Antique Copper Nesting Cocktail

Collection: SUNDRIES

Dimensions: 28w × 28d × 21h Weight: 56 / 56 lbs Cube: 4.19

Standard Finish: Apron Height: N/A

Materials: Metal, Smoked Glass

Highlight Striping: N/A

Contrasting Finishes or Paints: N/A

Conversion Varnish: N/A

Paint Match: N/A

Set of three nesting Cocktail Tables. Smoked glass tops with an Antique Copper frame and black metal bases. Consists of 8135-12-T and 8135-12-B, Sundries Antique Copper Nesting Cocktail Table Bases and Tops. Large Table: 28w X 28d X 21h, w Medium Table: 22w X 22d X 16.75h, Small Table: 19.25w X 19.25d X 14.25h

Country: INDIA Assembly Req: N

8136-12 — Price: \$2067

Sundries Bunching Cocktail Tables

Collection: SUNDRIES

Dimensions: 24w × 24d × 18h Weight: 220 / 220 lbs Cube: 5.99

Standard Finish: Apron Height: N/A

Materials: Metal & Carrara Marble

Highlight Striping: N/A

Contrasting Finishes or Paints: N/A

Conversion Varnish: N/A

Paint Match: N/A

Set of four bunching cocktail tables with Carrara marble tops and gold metal bases. Can be arranged together or used separately.

Country: INDIA Assembly Req: N

8137-81 — Price: \$2067

Caspian Writing Desk

Collection: CASPIAN

Dimensions: 52w × 24d × 31h Weight: 80 / 80 lbs Cube: 11.96

Standard Finish: Mar De Sala Apron Height: 25.25

Materials: Mango Solids

Highlight Striping: N/A

Contrasting Finishes or Paints: +\$517

Conversion Varnish: +\$450

Paint Match: +\$517

Mar De Sala finish with two drawers and Antique Bronze hardware.

Country: INDIA Assembly Req: Y

8137-99 — Price: \$3177

Caspian Console Table

Collection: CASPIAN

Dimensions: 74w × 18d × 35h Weight: 110 / 110 lbs Cube: 10.96

Standard Finish: Mar De Sala Apron Height: N/A

Materials: Mango Solids

Highlight Striping: N/A

Contrasting Finishes or Paints: N/A

Conversion Varnish: +\$477

Paint Match: +\$794

Mar De Sala finish with bottom shelf.

Country: INDIA Assembly Req: Y

8139-CT — Price: \$1107

Sundries French Café Table

Collection: SUNDRIES

Dimensions: 23w × 23d × 30h Weight: 86 / 86 lbs Cube: 13.46

Standard Finish: Apron Height: N/A

Materials: Iron & Carrara Marble

Highlight Striping: N/A

Contrasting Finishes or Paints: N/A

Conversion Varnish: N/A

Paint Match: N/A

Chiseled edge, Carrara marble top. Consists of 8139-CT-B (Base) and 8139-CT-T (Top)

Country: INDIA Assembly Req: Y

8142-TB — Price: \$597

Table Base

Collection:

Dimensions: 30w × 30d × 29h Weight: 30 / 30 lbs Cube: 1.75

Standard Finish: Cherry Apron Height: N/A

Materials: Rubberwood Solids

Highlight Striping: N/A

Contrasting Finishes or Paints: N/A

Conversion Varnish: N/A

Paint Match: +\$149

Finished in Cherry. Pairs with 472R-42 42in Round Table Top or 472S-42 42in Square Table Top

Country: CHINA Assembly Req: Y

Casegoods

8143-12 — Price: \$1137

Sundries Axis Nesting Cocktail Table

Collection: SUNDRIES

Dimensions: 24w × 24d × 18h Weight: 96 / 96 lbs Cube: 3.67

Standard Finish: Umber Apron Height: N/A

Materials: Mango Solids

Highlight Striping: N/A

Contrasting Finishes or Paints: N/A

Conversion Varnish: +\$450

Paint Match: +\$284

Individual table: 24w X 24d X 18h, Overall of Tables: 47.75w X 46.25d X 18h

Country: INDIA Assembly Req: Y

8144-17 — Price: \$3297

St. Florian Credenza

Collection: ST. FLORIAN

Dimensions: 79w × 19d × 35h Weight: 190 / 190 lbs Cube: 40.77

Standard Finish: Charred Ecru Apron Height: N/A

Materials: Mango Solids

Highlight Striping: N/A

Contrasting Finishes or Paints: N/A

Conversion Varnish: +\$495

Paint Match: +\$824

Finished in Charred Ecru with brass hardware and metal base. Four doors with adjustable interior shelves.

Country: INDIA Assembly Req: N

8144-43 — Price: \$3780

St. Florian Double Pedestal Dining Table

Collection: ST. FLORIAN

Dimensions: 84w × 42d × 30h Weight: 227 / 227 lbs Cube: 20.55

Standard Finish: Charred Ecru Apron Height: N/A

Materials: Mango Solids

Highlight Striping: N/A

Contrasting Finishes or Paints: N/A

Conversion Varnish: +\$567

Paint Match: +\$945

Marquetry patterned top finished in Charred Ecru. Consists of 8144-43-B (Base) and 8144-43-T (Top)

Country: INDIA Assembly Req: Y

8144-60 — Price: \$1887

St. Florian Dining Table 60" Round Top

Collection: ST. FLORIAN

Dimensions: 60w × 60d × 1.5h Weight: 134 / 134 lbs Cube: 12.99

Standard Finish: Charred Ecru Apron Height: N/A

Materials: Mango Solids

Highlight Striping: N/A

Contrasting Finishes or Paints: N/A

Conversion Varnish: +\$450

Paint Match: +\$472

Marquetry patterned top finished in Charred Ecru. Pairs with 8144-TB, St. Florian Pedestal Dining Table.

Country: INDIA Assembly Req: Y

8144-96 — Price: \$2997

St. Florian Credenza

Collection: ST. FLORIAN

Dimensions: 76w × 18d × 34h Weight: 179 / 179 lbs Cube: 36.71

Standard Finish: Charred Ecru Apron Height: N/A

Materials: Mango Solids

Highlight Striping: N/A

Contrasting Finishes or Paints: N/A

Conversion Varnish: +\$450

Paint Match: +\$749

Marquetry patterned door fronts finished in Charred Ecru with brass hardware and a metal base. Four doors and adjustable interior shelves.

Country: INDIA Assembly Req: N

8144-DT — Price: \$5097

St. Florian Double Pedestal Dining Table

Collection: ST. FLORIAN

Dimensions: 84w × 42d × 30h Weight: 312 / 312 lbs Cube: 19.07

Standard Finish: Charred Ecru Apron Height: N/A

Materials: Mango Solids

Highlight Striping: N/A

Contrasting Finishes or Paints: N/A

Conversion Varnish: +\$765

Paint Match: +\$1274

Marquetry patterned top finished in Charred Ecru. Consists of 8144-DT-B (Base) and 8144-DT-T (Top)

Country: INDIA Assembly Req: Y

8144-TB — Price: \$2187

St. Florian Dining Table Base

Collection: ST. FLORIAN

Dimensions: 36w × 36d × 28.5h Weight: 77 / 77 lbs Cube: 23.12

Standard Finish: Charred Ecru Apron Height: N/A

Materials: Mango Solids

Highlight Striping: N/A

Contrasting Finishes or Paints: N/A

Conversion Varnish: N/A

Paint Match: +\$547

Finished in Charred Ecru. Pairs with 8144-60, St. Florian Dining Table 60" Round Top.

Country: INDIA Assembly Req: Y

8146-12 — Price: \$1497

Sundries Stone Inlay Nesting Cocktail

Collection: SUNDRIES

Dimensions: 29.5w × 29.5d × 19h Weight: 124 / 124 lbs Cube: 17.27

Standard Finish: Apron Height: N/A

Materials: Brass Plated Metal, White Carrara Marble

Highlight Striping: N/A

Contrasting Finishes or Paints: N/A

Conversion Varnish: N/A

Paint Match: N/A

Set of two nesting cocktail tables with an inset marble top and metal base plated in Antique Brass. Large Table: 29.5w X 29.5d X 19h, Small Table: 23.75w X 23.75d X 15h

Country: INDIA Assembly Req: N

Casegoods

8147-12 — Price: \$1497

Soulful Textures Skipping Stone Nesting Cocktail Table

Collection: SOULFUL TEXTURES

Dimensions: 33w × 25d × 18h Weight: 42 / 42 lbs Cube: 4.25

Standard Finish: Aged Bronze Apron Height: N/A

Materials: Metal

Highlight Striping: N/A

Contrasting Finishes or Paints: N/A

Conversion Varnish: N/A

Paint Match: N/A

Four-piece layered cocktail tables smooth and textured metal tops finished in Aged Brass and black metal legs. Large w33 d25 h18. Medium w27.5 d21.5 h16. Small w19.75 d15.25 h14. Extra Small w13.75 d12.5 h14

Country: INDIA Assembly Req: N

8147-19 — Price: \$447

Soulful Textures End Table

Collection: SOULFUL TEXTURES

Dimensions: 19w × 19d × 21h Weight: 18 / 18 lbs Cube: 2.25

Standard Finish: Aged Bronze Apron Height: N/A

Materials: Metal

Highlight Striping: N/A

Contrasting Finishes or Paints: N/A

Conversion Varnish: N/A

Paint Match: N/A

Metal top finished in Aged Brass with a crosshatch texture and a metal tulip base in black. Large: w20 d20 h22.25 Small: w14.25 d14.25 h19

Country: INDIA Assembly Req: N

8147-49 — Price: \$747

Soulful Textures Nesting End Table

Collection: SOULFUL TEXTURES

Dimensions: 20w × 20d × 22h Weight: 56 / 56 lbs Cube: 14.57

Standard Finish: Aged Bronze Apron Height: N/A

Materials: Metal & Carrara Marble

Highlight Striping: N/A

Contrasting Finishes or Paints: N/A

Conversion Varnish: N/A

Paint Match: N/A

Set of two nesting tables with Carrara marble tops on Aged Brass metal bases. One table top features an inlaid Aged Brass pattern. Large - 20 x 20 x 21 3/4. Small - 13 3/4 x 13 3/4 x 19 1/4

Country: INDIA Assembly Req: N

8147-NS — Price: \$987

Soulful Textures Marble Inlay Nesting End Table

Collection: SOULFUL TEXTURES

Dimensions: 18.5w × 33.5d × 26h Weight: 50 / 50 lbs Cube: 5.81

Standard Finish: Apron Height: N/A

Materials: Stone with Antique Brass Inlay, Metal

Highlight Striping: N/A

Contrasting Finishes or Paints: N/A

Conversion Varnish: N/A

Paint Match: N/A

Set of two egg-shaped white stone tops. One features brass inlay pattern. Large table - 27 5/8 x 22 x 21 Small table - 20 x 15 3/4 x 17 1/2

Country: INDIA Assembly Req: N

8148-93 — Price: \$2727

Ivory Coast Cocktail Table

Collection: IVORY COAST

Dimensions: 54w × 30d × 18h Weight: 103 / 103 lbs Cube: 12.62

Standard Finish: Bleached Bone Apron Height: N/A

Materials: Mango Solids

Highlight Striping: N/A

Contrasting Finishes or Paints: N/A

Conversion Varnish: N/A

Paint Match: N/A

Bleached Bone inlaid top with a wooden base finished in Native.

Country: INDIA Assembly Req: N

8150-86 — Price: \$1257

Genesis Entry Table

Collection:

Dimensions: 36w × 36d × 30h Weight: 47 / 47 lbs Cube: 5.75

Standard Finish: Dusty Khaki Apron Height: N/A

Materials: Casual Solids & Veneers

Highlight Striping: N/A

Contrasting Finishes or Paints: N/A

Conversion Varnish: +\$450

Paint Match: +\$314

Country: CHINA Assembly Req: Y

8151-13 — Price: \$3147

Avington Cocktail Table

Collection:

Dimensions: 40w × 40d × 18.5h Weight: 236 / 236 lbs Cube: 31.2

Standard Finish: Apron Height: N/A

Materials: Mango Solids

Highlight Striping: N/A

Contrasting Finishes or Paints: N/A

Conversion Varnish: N/A

Paint Match: +\$787

Wooden chip layered base from Mango Solids. Consists of 8151-13-B (Base) and 8151-13-T (Top)

Country: INDIA Assembly Req: Y

8153-DT — Price: \$2997

Acquisition Dining Table

Collection: ACQUISITION

Dimensions: 84w × 40d × 30h Weight: 161 / 161 lbs Cube: 17.74

Standard Finish: Apron Height: N/A

Materials: Mango Solids

Highlight Striping: N/A

Contrasting Finishes or Paints: N/A

Conversion Varnish: +\$450

Paint Match: +\$749

Dining Table Top finished in Natural Clear. Consists of 8153-DT-B (Base) and 8153-DT-T (Top)

Country: INDIA Assembly Req: Y

Casegoods

8157-CT — Price: \$1197

Sundries Clover Leaf Cocktail Table

Collection: SUNDRIES

Dimensions: 29.5w × 29.5d × 14h Weight: 56 / 56 lbs Cube: 8.83

Standard Finish: Black Apron Height: N/A

Materials: Metal & Marble

Highlight Striping: N/A

Conversion Varnish: N/A

Contrasting Finishes or Paints: N/A

Paint Match: N/A

White marble top inset in gold metal frame. Consists of 8157-CT-B (Base) 8157-CT-T (Top)

Country: INDIA Assembly Req: Y

8158-13 — Price: \$1407

La Bella Cocktail Table

Collection: LA BELLA

Dimensions: 36w × 36d × 16.5h Weight: 68 / 68 lbs Cube: 19.51

Standard Finish: Apron Height: N/A

Materials: Metal

Highlight Striping: N/A

Conversion Varnish: N/A

Contrasting Finishes or Paints: N/A

Paint Match: N/A

Glass top. Consists of 8158-13-B (Base) and 8158-13-T (Top)

Country: INDIA Assembly Req: Y

8158-28 — Price: \$567

La Bella Accent Table

Collection: LA BELLA

Dimensions: 15.5w × 15.5d × 20.5h Weight: 21 / 21 lbs Cube: 4.3

Standard Finish: Apron Height: N/A

Materials: Metal Base / White Marble Top

Highlight Striping: N/A

Conversion Varnish: N/A

Contrasting Finishes or Paints: N/A

Paint Match: N/A

Hexagon shaped white marble top. Consists of 8158-28-B (Base) and 8158-28-T (Top)

Country: INDIA Assembly Req: Y

8158-90 — Price: \$1017

La Bella Chairside Table

Collection: LA BELLA

Dimensions: 20w × 20d × 20h Weight: 0 / 0 lbs Cube: 4.62

Standard Finish: Apron Height: N/A

Materials: Metal Base / White Marble Top

Highlight Striping: N/A

Conversion Varnish: N/A

Contrasting Finishes or Paints: N/A

Paint Match: N/A

Round white marble top with a metal base finished in Antique Brass. Consists of 8158-90-T and 8158-90-B, La Bella Chairside Table Top and Base.

Country: INDIA Assembly Req: N

8158-99 — Price: \$2037

La Bella Sofa Table

Collection: LA BELLA

Dimensions: 60.25w × 16.75d × 34h Weight: 119 / 119 lbs Cube: 31.17

Standard Finish: Apron Height: N/A

Materials: Metal Base / White Marble Top

Highlight Striping: N/A

Conversion Varnish: N/A

Contrasting Finishes or Paints: N/A

Paint Match: N/A

White marble top. Consists of 8158-99-B (Base) and 8158-99-T (Top)

Country: INDIA Assembly Req: Y

8158-CS — Price: \$987

La Bella Chairside Table

Collection: LA BELLA

Dimensions: 18w × 18d × 24h Weight: 0 / 0 lbs Cube: 4.5

Standard Finish: Apron Height: N/A

Materials: Metal

Highlight Striping: N/A

Conversion Varnish: N/A

Contrasting Finishes or Paints: N/A

Paint Match: N/A

Features a marble top with a gold leaf metal base. Consists of 8158-CS-T and 8158-CS-B, La Bella Chairside Table Top and Base.

Country: INDIA Assembly Req: N

8158-CT — Price: \$1317

La Bella Cocktail Table

Collection: LA BELLA

Dimensions: 30w × 30d × 18.75h Weight: 35 / 35 lbs Cube: 13.03

Standard Finish: Apron Height: N/A

Materials: Metal

Highlight Striping: N/A

Conversion Varnish: N/A

Contrasting Finishes or Paints: N/A

Paint Match: N/A

Wooden top in a Natural finish with a black metal base.

Country: INDIA Assembly Req: N

8158-ET — Price: \$1017

La Bella End Table

Collection: LA BELLA

Dimensions: 22.5w × 17.5d × 22.5h Weight: 0 / 0 lbs Cube: 5.12

Standard Finish: Apron Height: N/A

Materials: Metal Base / White Marble Top

Highlight Striping: N/A

Conversion Varnish: N/A

Contrasting Finishes or Paints: N/A

Paint Match: N/A

Carrara marble top with an antique brass metal base. Consists of 8158-ET-T and 8158-ET-B, La Bella End Table Top and Base.

Country: INDIA Assembly Req: N

Casegoods

8159-12 — Price: \$987

Sundries Starburst Rectangular Nesting Cocktail

Collection: SUNDRIES

Dimensions: 24.5w × 24d × 17.75h Weight: 42 / 42 lbs Cube: 8.43

Standard Finish: Apron Height: N/A

Materials: Metal

Highlight Striping: N/A

Contrasting Finishes or Paints: N/A

Conversion Varnish: N/A

Paint Match: N/A

Set of two rectangular end tables with bronze, textured metal tops in a Starburst design and black metal bases. Large Table: 24.5w X 24d X 17h, Small Table: 18.25w X 18.25d X 17.75h
Country: INDIA Assembly Req: N

8160-46 — Price: \$1077

Revelation Oval Cocktail Table

Collection: REVELATION

Dimensions: 44w × 26d × 19.5h Weight: 45 / 45 lbs Cube: 6.04

Standard Finish: Graphite Apron Height: N/A

Materials: Elm Solids & Veneers

Highlight Striping: N/A

Contrasting Finishes or Paints: N/A

Conversion Varnish: +\$450

Paint Match: +\$269

Finished in a deep Granite and hand wiped to reveal rich, brown undertones.

Country: CHINA Assembly Req: Y

8160-47 — Price: \$1047

Revelation Oval End Table

Collection: REVELATION

Dimensions: 26w × 18d × 24.5h Weight: 14 / 14 lbs Cube: 10.9

Standard Finish: Graphite Apron Height: N/A

Materials: Elm Solids & Veneers

Highlight Striping: N/A

Contrasting Finishes or Paints: N/A

Conversion Varnish: +\$450

Paint Match: +\$262

Finished in a deep Granite and hand wiped to reveal rich, brown undertones. One fixed shelf.

Country: CHINA Assembly Req: Y

8160-90 — Price: \$1347

Revelation Lamp Table

Collection: REVELATION

Dimensions: 28w × 28d × 29h Weight: 40 / 40 lbs Cube: 16.66

Standard Finish: Graphite Apron Height: N/A

Materials: Elm Solids & Veneers

Highlight Striping: N/A

Contrasting Finishes or Paints: N/A

Conversion Varnish: +\$450

Paint Match: +\$337

Finished in a deep Granite and hand wiped to reveal rich, brown undertones. One fixed shelf.

Country: CHINA Assembly Req: Y

8160-95 — Price: \$1167

Revelation Rectangular End Table

Collection: REVELATION

Dimensions: 28w × 19d × 28h Weight: 45 / 45 lbs Cube: 11.76

Standard Finish: Graphite Apron Height: N/A

Materials: Elm Solids & Veneers

Highlight Striping: N/A

Contrasting Finishes or Paints: N/A

Conversion Varnish: +\$450

Paint Match: +\$292

Finished in a deep Granite and hand wiped to reveal rich, brown undertones. One drawer and one fixed shelf.

Country: CHINA Assembly Req: Y

8163-90 — Price: \$597

Goldie Drink Table

Collection: SUNDRIES

Dimensions: 15w × 15d × 22h Weight: 25 / 25 lbs Cube: 2.86

Standard Finish: Apron Height: N/A

Materials: Metal

Highlight Striping: N/A

Contrasting Finishes or Paints: N/A

Conversion Varnish: N/A

Paint Match: N/A

Black finish exterior with gold leaf interior.

Country: INDIA Assembly Req: N

8163-CS — Price: \$597

Sundries Round Trumpet Based Chairside Table

Collection: SUNDRIES

Dimensions: 24w × 24d × 15h Weight: 16 / 16 lbs Cube: 4.66

Standard Finish: Apron Height: N/A

Materials: Metal

Highlight Striping: N/A

Contrasting Finishes or Paints: N/A

Conversion Varnish: N/A

Paint Match: N/A

Antique Copper table top with black, powder coated trumpet base.

Country: INDIA Assembly Req: Y

8164-16 — Price: \$1197

Dining Table Base

Collection: WESTWOOD

Dimensions: 20w × 20d × 29h Weight: 136 / 136 lbs Cube: 6.71

Standard Finish: Graphite Apron Height: 29

Materials: Red Oak Solids and Veneers

Highlight Striping: N/A

Contrasting Finishes or Paints: N/A

Conversion Varnish: N/A

Paint Match: N/A

Country: CHINA Assembly Req: Y

Casegoods

8164-17 — Price: \$3207

Westwood Sideboard

Collection: WESTWOOD

Dimensions: 60w × 15d × 41h Weight: 210 / 210 lbs Cube: 24.41

Standard Finish: Graphite Apron Height: N/A

Materials: Select Oak Solids & Veneers

Highlight Striping: N/A

Contrasting Finishes or Paints: N/A

Conversion Varnish: N/A

Paint Match: +\$802

Finished in Graphite with brass accents, a marble inset top, three top drawers, three base level doors, and one adjustable shelf behind each door.

Country: CHINA Assembly Req: Y

8164-19 — Price: \$1257

Westwood Round End Table

Collection: WESTWOOD

Dimensions: 24w × 24d × 26h Weight: 45 / 45 lbs Cube: 3.05

Standard Finish: Graphite Apron Height: N/A

Materials: Select Oak Solids & Veneers

Highlight Striping: N/A

Contrasting Finishes or Paints: N/A

Conversion Varnish: N/A

Paint Match: +\$314

Finished in Graphite with brass accents and a marble inset top.

Country: CHINA Assembly Req: Y

8164-88 — Price: \$807

Westwood Drink Table

Collection: WESTWOOD

Dimensions: 16w × 16d × 26h Weight: 25 / 25 lbs Cube: 1.4

Standard Finish: Graphite Apron Height: N/A

Materials: Select Oak Solids & Veneers

Highlight Striping: N/A

Contrasting Finishes or Paints: N/A

Conversion Varnish: N/A

Paint Match: N/A

Finished in Graphite with brass accents and a marble top.

Country: CHINA Assembly Req: N

8164-AC — Price: \$2847

Westwood Accent Chest

Collection: WESTWOOD

Dimensions: 48w × 18d × 36h Weight: 135 / 135 lbs Cube: 23.78

Standard Finish: Graphite Apron Height: N/A

Materials: Select Oak Solids & Veneers

Highlight Striping: N/A

Contrasting Finishes or Paints: N/A

Conversion Varnish: N/A

Paint Match: +\$712

Finished in Graphite with brass accents, a marble inset top, two doors, and an adjustable interior shelf behind each door.

Country: CHINA Assembly Req: Y

8164-BT — Price: \$1707

Westwood Counter Height Table

Collection: WESTWOOD

Dimensions: 36w × 36d × 36h Weight: 85 / 85 lbs Cube: 7.82

Standard Finish: Graphite Apron Height: N/A

Materials: Select Oak Solids & Veneers

Highlight Striping: N/A

Contrasting Finishes or Paints: N/A

Conversion Varnish: N/A

Paint Match: N/A

Finished in Graphite with brass accents.

Country: CHINA Assembly Req: Y

8164-CB — Price: \$1287

Counter Height Table Base

Collection: WESTWOOD

Dimensions: 20w × 20d × 35h Weight: 136 / 136 lbs Cube: 8.1

Standard Finish: Graphite Apron Height: 35

Materials: Red Oak Solids and Veneers

Highlight Striping: N/A

Contrasting Finishes or Paints: N/A

Conversion Varnish: N/A

Paint Match: N/A

Country: CHINA Assembly Req: Y

8168-94 — Price: \$1647

Beatbox End Table

Collection: BEATBOX

Dimensions: 24w × 24d × 24h Weight: 125 / 125 lbs Cube: 13.78

Standard Finish: Metallic Onyx Apron Height: N/A

Materials: Metal

Highlight Striping: N/A

Contrasting Finishes or Paints: N/A

Conversion Varnish: N/A

Paint Match: N/A

Forged steel finished in Metallic Onyx with Brass hardware and 3/16" tempered glass top. One Drawer.

Country: VIETNAM Assembly Req: N

8171-49 — Price: \$507

Sundries Round Nesting End Table

Collection: SUNDRIES

Dimensions: 18w × 18d × 20h Weight: 26 / 26 lbs Cube: 0.82

Standard Finish: Apron Height: N/A

Materials: Metal

Highlight Striping: N/A

Contrasting Finishes or Paints: N/A

Conversion Varnish: N/A

Paint Match: N/A

Set of two, round metal spot tables finished in Antique Copper. Metal tops feature a textured, starburst design. Large Table: 18w X 18d X 20h, Small Table: 15w X 15d X 18h

Country: INDIA Assembly Req: Y

Casegoods

8172-88 — Price: \$627

Bobo Drink Table

Collection: SUNDRIES

Dimensions: 12w × 12d × 22h Weight: 17 / 17 lbs Cube: 1.83

Standard Finish: Apron Height: N/A

Materials: Mango Solids

Highlight Striping: N/A

Contrasting Finishes or Paints: N/A

Conversion Varnish: +\$450

Paint Match: +\$157

Country: INDIA Assembly Req: N

8173-CH — Price: \$3147

Willow Chest

Collection: SUNDRIES

Dimensions: 42w × 19d × 38h Weight: 53 / 53 lbs Cube: 17.54

Standard Finish: Apron Height: N/A

Materials: Mango Solids

Highlight Striping: N/A

Contrasting Finishes or Paints: N/A

Conversion Varnish: +\$472

Paint Match: +\$787

Features two doors with magnetic door catches. Two adjustable shelves behind each door. Vented back panel.

Country: INDIA Assembly Req: N

8174-CH — Price: \$2397

Penelope Chest

Collection: SUNDRIES

Dimensions: 42w × 18d × 36h Weight: 150 / 150 lbs Cube: 15.75

Standard Finish: Apron Height: N/A

Materials: Mango Solids

Highlight Striping: N/A

Contrasting Finishes or Paints: N/A

Conversion Varnish: +\$450

Paint Match: +\$599

Features two doors with magnetic door catches. Two adjustable shelves behind each door. Vented back panel.

Country: INDIA Assembly Req: N

8181-48 — Price: \$5787

Sundries Bar Cabinet

Collection: SUNDRIES

Dimensions: 36w × 19d × 70h Weight: 289 / 289 lbs Cube: 36.92

Standard Finish: Sheer Dove Apron Height: 23.5

Materials: Quartered Ash Solids & Veneers, Brushed Brass Metal

Highlight Striping: N/A

Contrasting Finishes or Paints: +\$1447

Conversion Varnish: +\$868

Paint Match: +\$1447

Finished in Sheer Dove with a Brushed Brass metal base and two doors, two interior drawers, mirrored back panel, pull-out shelf, LED lighting, and bottle and stemware storage. Doors open to 270 degrees. Also available in any Monogram Finish as M181-48.

Country: CHINA Assembly Req: N

Also Available:

M181-48 in Custom Finishes at \$6897

8181-CH — Price: \$2397

Bronx Chest

Collection: SUNDRIES

Dimensions: 52w × 18d × 38h Weight: 150 / 150 lbs Cube: 20.58

Standard Finish: Apron Height: N/A

Materials: Mango Solids, Metal

Highlight Striping: N/A

Contrasting Finishes or Paints: N/A

Conversion Varnish: +\$450

Paint Match: +\$599

Country: INDIA Assembly Req: N

8184-TB — Price: \$1107

Trumpet Dining Height Base

Collection: LIVE EDGE, LAMINATE TABLE TOP AND BASE

Dimensions: 20.5w × 20.5d × 28h Weight: 60 / 60 lbs Cube: 11.93

Standard Finish: Blanca Apron Height: N/A

Materials: Metal

Highlight Striping: N/A

Contrasting Finishes or Paints: N/A

Conversion Varnish: N/A

Paint Match: N/A

Trumpet shaped metal base in Blanca finish. This style is sold as one base. When pairing with rectangular Live Edge tops, two bases are required.

Country: CHINA Assembly Req: Y

8186-CB — Price: \$687

Titan Café Height Base

Collection: LIVE EDGE, LAMINATE TABLE TOP AND BASE

Dimensions: 24w × 24d × 29h Weight: 40 / 40 lbs Cube: 2.25

Standard Finish: Apron Height: 28

Materials: Metal

Highlight Striping: N/A

Contrasting Finishes or Paints: N/A

Conversion Varnish: N/A

Paint Match: N/A

Black metal base. This style is sold as one base. When pairing with rectangular Live Edge tops, two bases are required.

Country: CHINA Assembly Req: Y

8189-19 — Price: \$1197

Expedition Round End Table

Collection: EXPEDITION

Dimensions: 25w × 25d × 25h Weight: 51 / 51 lbs Cube: 3.4

Standard Finish: Grecian Clay Apron Height: 23.25

Materials: Figured Eucalyptus & Oak Solids, Metal Accents

Highlight Striping: N/A

Contrasting Finishes or Paints: N/A

Conversion Varnish: +\$450

Paint Match: +\$299

Metal Accents. Finished. Finished in Grecian Clay. Also available in any Monogram Finish as M189-19

Country: CHINA Assembly Req: N

Also Available:

M189-19 in Custom Finishes at \$1737

Casegoods

8189-81 — Price: \$4377

Expedition Pedestal Desk

Collection: EXPEDITION

Dimensions: 60w × 28d × 30h Weight: 234 / 234 lbs Cube: 36.4

Standard Finish: Grecian Clay Apron Height: N/A

Materials: Figured Eucalyptus & Oak Solids

Highlight Striping: N/A

Conversion Varnish: +\$657

Contrasting Finishes or Paints: +\$1094

Paint Match: +\$1094

Finished in Grecian Clay with a contrasting front panel in Creme Brulee and cast brass hardware. Includes a center keyboard drawer, two pencil drawers and two storage drawers, two lateral file drawers, and two grommets for cord management in the desktop. Also available in any Monogram Finish as M189-81

Country: CHINA Assembly Req: N

Also Available:

M189-81 in Custom Finishes at \$5847

8189-88 — Price: \$927

Expedition Martini Table

Collection: EXPEDITION

Dimensions: 17.75w × 17.75d × 23h Weight: 29 / 29 lbs Cube: 2.11

Standard Finish: Grecian Clay Apron Height: 21

Materials: Figured Eucalyptus & Oak Solids, Metal Accents

Highlight Striping: N/A

Conversion Varnish: +\$450

Contrasting Finishes or Paints: N/A

Paint Match: +\$232

Metal Accents. Finished. Finished in Grecian Clay. Also available in any Monogram Finish as M189-88

Country: CHINA Assembly Req: N

Also Available:

M189-88 in Custom Finishes at \$1407

8189-91 — Price: \$2727

Expedition Cocktail Table

Collection: EXPEDITION

Dimensions: 50w × 30d × 19h Weight: 138 / 138 lbs Cube: 23.2

Standard Finish: Grecian Clay Apron Height: N/A

Materials: Figured Eucalyptus & Oak Solids, Cast Iron Base

Highlight Striping: N/A

Conversion Varnish: +\$450

Contrasting Finishes or Paints: +\$682

Paint Match: +\$682

A low table designed with a rectangular wood case veneered in richly figured eucalyptus and finished in Grecian Clay. Three storage drawers on one side with cast brass hardware and a cast iron base with linear corner legs joined by a low X-stretcher. Also available in any Monogram Finish as M189-91

Country: CHINA Assembly Req: Y

Also Available:

M189-91 in Custom Finishes at \$4047

8189-95 — Price: \$1707

Expedition End Table

Collection: EXPEDITION

Dimensions: 22w × 28d × 26h Weight: 73 / 73 lbs Cube: 13.88

Standard Finish: Grecian Clay Apron Height: N/A

Materials: Figured Eucalyptus & Oak Solids, Cast Iron Base

Highlight Striping: N/A

Conversion Varnish: +\$450

Contrasting Finishes or Paints: +\$427

Paint Match: +\$427

Eucalyptus veneered case finished in Grecian Clay, housing a storage drawer and mounted with cast brass hardware on a cast iron base with a low X-stretcher. Also available in any Monogram Finish as M189-95

Country: CHINA Assembly Req: Y

Also Available:

M189-95 in Custom Finishes at \$2697

8189-96 — Price: \$2547

Expedition Console

Collection: EXPEDITION

Dimensions: 56w × 16d × 34h Weight: 104 / 104 lbs Cube: 24.96

Standard Finish: Grecian Clay Apron Height: N/A

Materials: Figured Eucalyptus & Oak Solids, Cast Iron Base

Highlight Striping: N/A

Conversion Varnish: +\$450

Contrasting Finishes or Paints: +\$637

Paint Match: +\$637

Eucalyptus veneered case finished in Grecian Clay, housing three storage drawers and mounted with cast brass hardware on a cast iron base with a low X-stretcher. Also available in any Monogram Finish as M189-96

Country: CHINA Assembly Req: N

Also Available:

M189-96 in Custom Finishes at \$3897

8189-AD — Price: \$2637

Expedition Console

Collection: EXPEDITION

Dimensions: 60w × 15.25d × 34h Weight: 115 / 115 lbs Cube: 26.4

Standard Finish: Grecian Clay Apron Height: 28.25

Materials: Figured Eucalyptus & Oak Solids

Highlight Striping: N/A

Conversion Varnish: +\$450

Contrasting Finishes or Paints: +\$659

Paint Match: +\$659

Three Drawers. Finished in Grecian Clay with contrast drawer fronts in Creme Brulee. Also available in any Monogram Finish as M189-AD

Country: CHINA Assembly Req: N

Also Available:

M189-AD in Custom Finishes at \$3597

8189-CC — Price: \$1347

Expedition End Table

Collection: EXPEDITION

Dimensions: 14w × 22d × 23h Weight: 63 / 63 lbs Cube: 7.62

Standard Finish: Grecian Clay Apron Height: 7.5

Materials: Figured Eucalyptus & Oak Solids, Cast Iron Base

Highlight Striping: N/A

Conversion Varnish: +\$450

Contrasting Finishes or Paints: +\$337

Paint Match: +\$337

Two Drawers. Finished in Grecian Clay with contrast drawer fronts in Creme Brulee. Cast Iron Base. Also available in any Monogram Finish as M189-CC

Country: CHINA Assembly Req: N

Also Available:

M189-CC in Custom Finishes at \$2097

8190-88 — Price: \$747

Townsend Drink Table

Collection: TOWNSEND

Dimensions: 14.5w × 14.5d × 24h Weight: 15 / 15 lbs Cube: 5.2

Standard Finish: Cognac Apron Height: N/A

Materials: Elm Solids & Veneers

Highlight Striping: N/A

Conversion Varnish: +\$450

Contrasting Finishes or Paints: N/A

Paint Match: +\$187

Finished in Cognac with one fixed shelf.

Country: CHINA Assembly Req: N

Casegoods

8191-81 — Price: \$3837

Park Avenue Desk

Collection: PARK AVENUE

Dimensions: 64w × 20d × 36.5h Weight: 160 / 160 lbs Cube: 44.31

Standard Finish: Grecian Clay Apron Height: N/A

Materials: Oak Solids, Figured Eucalyptus Veneer, Metal

Highlight Striping: N/A

Contrasting Finishes or Paints: +\$959

Conversion Varnish: +\$576

Paint Match: +\$959

Finished in Grecian Clay. Features three drawers, center drawer with pencil tray and standard outlet with USB port. Also available in any Monogram Finish as M191-81.

Country: CHINA Assembly Req: N

Also Available:

M191-81 in Custom Finishes at \$4797

8191-84 — Price: \$2967

Park Avenue Lateral File

Collection: PARK AVENUE

Dimensions: 36w × 19d × 29h Weight: 152 / 152 lbs Cube: 16.4

Standard Finish: Grecian Clay Apron Height: N/A

Materials: Oak Solids, Figured Eucalyptus Veneer, Metal

Highlight Striping: N/A

Contrasting Finishes or Paints: +\$742

Conversion Varnish: +\$450

Paint Match: +\$742

Finished in Grecian Clay. Features two drawers with lateral files, two doors with interior printer storage, and a standard outlet with a USB port. Also available in any Monogram Finish as M191-84.

Country: CHINA Assembly Req: N

Also Available:

M191-84 in Custom Finishes at \$3597

8191-MF — Price: \$1497

Park Avenue Mobile File

Collection: PARK AVENUE

Dimensions: 15.5w × 18d × 24.75h Weight: 79 / 79 lbs Cube: 6.38

Standard Finish: Grecian Clay Apron Height: N/A

Materials: Oak Solids, Figured Eucalyptus Veneer, Metal

Highlight Striping: N/A

Contrasting Finishes or Paints: +\$374

Conversion Varnish: +\$450

Paint Match: +\$374

Finished in Grecian Clay with acrylic hardware and hidden casters. Includes one standard top drawer and one bottom lateral file drawer with a hidden pencil drawer. Fits under the 8191-81 Park Avenue Desk and M191-81 Monogram Park Avenue Desk. Also available in any Monogram Finish as M191-MF.

Country: CHINA Assembly Req: N

Also Available:

M191-MF in Custom Finishes at \$1887

8192-TB — Price: \$1797

Cracked Ice Dining Table Base

Collection: LIVE EDGE

Dimensions: 29w × 29d × 28h Weight: 23 / 23 lbs Cube: 16.96

Standard Finish: Gold Apron Height: N/A

Materials: Metal

Highlight Striping: N/A

Contrasting Finishes or Paints: N/A

Conversion Varnish: N/A

Paint Match: N/A

Metal base in Gold finish.

Country: CHINA Assembly Req: N

8194-88 — Price: \$1047

Vero Drink Table

Collection: VERO

Dimensions: 19w × 19d × 25h Weight: 25 / 25 lbs Cube: 6.87

Standard Finish: Sable Apron Height: N/A

Materials: Rubberwood, Tulip Wood Solids & Veneers

Highlight Striping: N/A

Contrasting Finishes or Paints: N/A

Conversion Varnish: +\$450

Paint Match: +\$262

High pressure laminate top with a solid wood edge finished in Sable. The cross leg metal base is finished in Polished Nickel.

Country: CHINA Assembly Req: N

8194-98 — Price: \$1587

Vero Storage Lamp Table

Collection: VERO

Dimensions: 24w × 24d × 26h Weight: 55 / 55 lbs Cube: 11.68

Standard Finish: Sable Apron Height: N/A

Materials: Rubberwood, Tulip Wood Solids & Veneers

Highlight Striping: N/A

Contrasting Finishes or Paints: N/A

Conversion Varnish: +\$450

Paint Match: +\$397

High pressure laminate top with solid wood edge finished in Sable.

Country: CHINA Assembly Req: N

8195-13 — Price: \$1947

Veneto Cocktail Table

Collection: VENETO

Dimensions: 36w × 36d × 18h Weight: 148 / 148 lbs Cube: 26.75

Standard Finish: Apron Height: N/A

Materials: Hand Forged Metal, Calcutta Stone

Highlight Striping: N/A

Contrasting Finishes or Paints: N/A

Conversion Varnish: N/A

Paint Match: N/A

Hand-forged, hammered metal frame finished in Antique Gold with a Calcutta marble top.

Country: INDIA Assembly Req: N

8195-88 — Price: \$447

Veneto Drink Table

Collection: VENETO

Dimensions: 10w × 10d × 22h Weight: 14 / 14 lbs Cube: 3.4

Standard Finish: Apron Height: N/A

Materials: Hand Forged Metal, Calcutta Stone

Highlight Striping: N/A

Contrasting Finishes or Paints: N/A

Conversion Varnish: N/A

Paint Match: N/A

Hand-forged, hammered metal frame finished in Antique Gold with a Calcutta marble top.

Country: INDIA Assembly Req: N

Casegoods

8195-AT — Price: \$597

Veneto Accent Table

Collection: VENETO

Dimensions: 14w × 10d × 22h Weight: 23 / 23 lbs Cube: 3.66

Standard Finish: Apron Height: N/A

Materials: Hand Forged Metal, Calcutta Stone

Highlight Striping: N/A

Contrasting Finishes or Paints: N/A

Conversion Varnish: N/A

Paint Match: N/A

Hand-forged, hammered metal frame finished in Antique Gold with an inset Calcutta marble top.

Country: INDIA Assembly Req: N

8195-CS — Price: \$1167

Veneto End Table

Collection: VENETO

Dimensions: 18w × 18d × 22h Weight: 65 / 65 lbs Cube: 7.79

Standard Finish: Apron Height: N/A

Materials: Hand Forged Metal, Calcutta Stone

Highlight Striping: N/A

Contrasting Finishes or Paints: N/A

Conversion Varnish: N/A

Paint Match: N/A

Hand-forged, hammered metal frame finished in Antique Gold with a Calcutta marble top.

Country: INDIA Assembly Req: N

8196-90 — Price: \$1047

Artisan Chairside Table

Collection: ARTISAN

Dimensions: 20w × 20d × 25h Weight: 20 / 20 lbs Cube: 7.84

Standard Finish: Mica Apron Height: N/A

Materials: Birch Solids with Fashioned Cherry Veneers

Highlight Striping: N/A

Contrasting Finishes or Paints: N/A

Conversion Varnish: +\$450

Paint Match: +\$262

Finished in Mica and lightly wiped to achieve a warm transparency of grain.

Country: CHINA Assembly Req: N

8870-36 — Price: \$1794

Dining Table

Collection: WESTWOOD

Dimensions: 36w × 36d × 30h Weight: 180 / 180 lbs Cube: 22.5

Standard Finish: Graphite Apron Height: N/A

Materials: Red Oak Solids and Veneers, High Pressure Laminate

Highlight Striping: N/A

Contrasting Finishes or Paints: N/A

Conversion Varnish: N/A

Paint Match: N/A

Features 8164-16 Dining Height base in Graphite finish, paired with 425R-36 Top. 36" Diameter in Midnight Finish with reversed beveled edge.

Country: CHINA Assembly Req: Y

8871-36 — Price: \$1794

Dining Table

Collection: WESTWOOD

Dimensions: 36w × 36d × 30h Weight: 180 / 180 lbs Cube: 22.5

Standard Finish: Graphite Apron Height: N/A

Materials: Red Oak Solids and Veneers, High Pressure Laminate

Highlight Striping: N/A

Contrasting Finishes or Paints: N/A

Conversion Varnish: N/A

Paint Match: N/A

Features 8164-16 Dining Height base in Graphite finish, paired with 421R-36 Top. 36" Diameter in Heathered Gray Finish with reversed beveled edge.

Country: CHINA Assembly Req: Y

8872-36 — Price: \$2394

Dining Table

Collection: WESTWOOD

Dimensions: 36w × 36d × 30h Weight: 228 / 228 lbs Cube: 22.5

Standard Finish: Graphite Apron Height: N/A

Materials: Red Oak Solids and Veneers, White Carrara Marble

Highlight Striping: N/A

Contrasting Finishes or Paints: N/A

Conversion Varnish: N/A

Paint Match: N/A

Features 8164-16 Dining Height base in Graphite finish, paired with 8005-36 Top. 36" Diameter in White Carrara marble with pencil edge.

Country: CHINA Assembly Req: Y

8873-36 — Price: \$1884

Counter Height Table

Collection: WESTWOOD

Dimensions: 36w × 36d × 36h Weight: 191 / 191 lbs Cube: 27

Standard Finish: Graphite Apron Height: N/A

Materials: Red Oak Solids and Veneers

Highlight Striping: N/A

Contrasting Finishes or Paints: N/A

Conversion Varnish: N/A

Paint Match: N/A

Features 8164-CB Counter Height base in Graphite finish, paired with 425R-36 Top. 36" Diameter in Midnight Finish with reversed beveled edge.

Country: CHINA Assembly Req: Y

8874-36 — Price: \$1884

Counter Height Table

Collection: WESTWOOD

Dimensions: 36w × 36d × 36h Weight: 191 / 191 lbs Cube: 27

Standard Finish: Graphite Apron Height: N/A

Materials: Red Oak Solids and Veneers, High Pressure Laminate

Highlight Striping: N/A

Contrasting Finishes or Paints: N/A

Conversion Varnish: N/A

Paint Match: N/A

Features 8164-CB Counter Height base in Graphite finish, paired with 421R-36 Top. 36" Diameter in Heathered Gray Finish with reversed beveled edge.

Country: CHINA Assembly Req: Y

Casegoods

8875-36 — Price: \$2484

Dining Table

Collection: WESTWOOD

Dimensions: 36w × 36d × 37h Weight: 228 / 228 lbs Cube: 27.75

Standard Finish: Graphite Apron Height: N/A

Materials: Red Oak Solids and Veneers, White Carrara Marble

Highlight Striping: N/A

Contrasting Finishes or Paints: N/A

Conversion Varnish: N/A

Paint Match: N/A

Features 8164-CB Counter Height base in Graphite finish, paired with 8005-36 Top. 36" Diameter in White Carrara marble with pencil edge.

Country: CHINA Assembly Req: Y

8876-36 — Price: \$1794

Dining Table

Collection: PROVENCE

Dimensions: 36w × 36d × 30h Weight: 180 / 180 lbs Cube: 22.5

Standard Finish: Sandstone Apron Height: N/A

Materials: Red Oak Solids and Veneers, High Pressure Laminate

Highlight Striping: N/A

Contrasting Finishes or Paints: N/A

Conversion Varnish: N/A

Paint Match: N/A

Features 8119-16 Dining Height base in Sandstone finish, paired with 425R-36 Top. 36" Diameter in Midnight Finish with reversed beveled edge.

Country: CHINA Assembly Req: Y

8877-36 — Price: \$1794

Dining Table

Collection: PROVENCE

Dimensions: 36w × 36d × 30h Weight: 180 / 180 lbs Cube: 22.5

Standard Finish: Sandstone Apron Height: N/A

Materials: Red Oak Solids and Veneers, High Pressure Laminate

Highlight Striping: N/A

Contrasting Finishes or Paints: N/A

Conversion Varnish: N/A

Paint Match: N/A

Features 8119-16 Dining Height base in Sandstone finish, paired with 421R-36 Top. 36" Diameter in Heathered Gray Finish with reversed beveled edge.

Country: CHINA Assembly Req: Y

8878-36 — Price: \$2394

Dining Table

Collection: PROVENCE

Dimensions: 36w × 36d × 30h Weight: 228 / 228 lbs Cube: 22.5

Standard Finish: Sandstone Apron Height: N/A

Materials: Red Oak Solids and Veneers, White Carrara Marble

Highlight Striping: N/A

Contrasting Finishes or Paints: N/A

Conversion Varnish: N/A

Paint Match: N/A

Features 8119-16 Dining Height base in Sandstone finish, paired with 8005-36 Top. 36" Diameter in White Carrara marble with pencil edge.

Country: CHINA Assembly Req: Y

8879-36 — Price: \$1884

Counter Height Table

Collection: PROVENCE

Dimensions: 36w × 36d × 36h Weight: 180 / 180 lbs Cube: 27

Standard Finish: Sandstone Apron Height: N/A

Materials: Red Oak Solids and Veneers, High Pressure Laminate

Highlight Striping: N/A

Contrasting Finishes or Paints: N/A

Conversion Varnish: N/A

Paint Match: N/A

Features 8119-CB Counter Height base in Sandstone finish, paired with 425R-36 Top. 36" Diameter in Midnight Finish with reversed beveled edge.

Country: CHINA Assembly Req: Y

8880-36 — Price: \$1884

Counter Height Table

Collection: PROVENCE

Dimensions: 36w × 36d × 36h Weight: 180 / 180 lbs Cube: 27

Standard Finish: Sandstone Apron Height: N/A

Materials: Red Oak Solids and Veneers, High Pressure Laminate

Highlight Striping: N/A

Contrasting Finishes or Paints: N/A

Conversion Varnish: N/A

Paint Match: N/A

Features 8119-CB Counter Height base in Sandstone finish, paired with 421R-36 Top. 36" Diameter in Heathered Gray Finish with reversed beveled edge.

Country: CHINA Assembly Req: Y

8881-36 — Price: \$2484

Counter Height Table

Collection: PROVENCE

Dimensions: 36w × 36d × 37h Weight: 228 / 228 lbs Cube: 27.75

Standard Finish: Sandstone Apron Height: N/A

Materials: Red Oak Solids and Veneers, White Carrara Marble

Highlight Striping: N/A

Contrasting Finishes or Paints: N/A

Conversion Varnish: N/A

Paint Match: N/A

Features 8119-CB Counter Height base in Sandstone finish, paired with 8005-36 Top. 36" Diameter in White Carrara marble with pencil edge.

Country: CHINA Assembly Req: Y

8882-42 — Price: \$1944

Dining Table

Collection: WESTWOOD

Dimensions: 42w × 42d × 30h Weight: 189 / 189 lbs Cube: 30.62

Standard Finish: Graphite Apron Height: N/A

Materials: Red Oak Solids and Veneers, High Pressure Laminate

Highlight Striping: N/A

Contrasting Finishes or Paints: N/A

Conversion Varnish: N/A

Paint Match: N/A

Features 8164-16 Dining Height base in Graphite finish, paired with 425S-42 Top. 42" square top in Midnight Finish with reversed beveled edge.

Country: CHINA Assembly Req: Y

Casegoods

8883-42 — Price: \$1944

Dining Table

Collection: WESTWOOD

Dimensions: 42w × 42d × 30h Weight: 189 / 189 lbs Cube: 30.62

Standard Finish: Graphite Apron Height: N/A

Materials: Red Oak Solids and Veneers, High Pressure Laminate

Highlight Striping: N/A Contrasting Finishes or Paints: N/A

Conversion Varnish: N/A Paint Match: N/A

Features 8164-16 Dining Height base in Graphite finish, paired with 421S-42 Top. 42" square in Heathered Gray Finish with reversed beveled edge.

Country: CHINA Assembly Req: Y

8884-42 — Price: \$2094

Dining Table

Collection: WESTWOOD

Dimensions: 42w × 42d × 30h Weight: 258 / 258 lbs Cube: 30.62

Standard Finish: Graphite Apron Height: N/A

Materials: Red Oak Solids and Veneers, High Pressure Laminate

Highlight Striping: N/A Contrasting Finishes or Paints: N/A

Conversion Varnish: N/A Paint Match: N/A

Features 8164-16 Dining Height base in Graphite finish, paired with 4443-TP Top. 42" square in Perfect Walnut Finish with eased edge.

Country: CHINA Assembly Req: Y

8885-42 — Price: \$2094

Dining Table

Collection: WESTWOOD

Dimensions: 42w × 42d × 30h Weight: 258 / 258 lbs Cube: 30.62

Standard Finish: Graphite Apron Height: N/A

Materials: Red Oak Solids and Veneers, High Pressure Laminate

Highlight Striping: N/A Contrasting Finishes or Paints: N/A

Conversion Varnish: N/A Paint Match: N/A

Features 8164-16 Dining Height base in Graphite finish, paired with 4442-TP Top. 42" square in Coal Finish with eased edge.

Country: CHINA Assembly Req: Y

8886-42 — Price: \$2034

Dining Table

Collection: WESTWOOD

Dimensions: 42w × 42d × 36h Weight: 189 / 189 lbs Cube: 36.75

Standard Finish: Graphite Apron Height: N/A

Materials: Red Oak Solids and Veneers, High Pressure Laminate

Highlight Striping: N/A Contrasting Finishes or Paints: N/A

Conversion Varnish: N/A Paint Match: N/A

Features 8164-CB Counter Height base in Graphite finish, paired with 425S-42 Top. 42" square top in Midnight Finish with reversed beveled edge.

Country: CHINA Assembly Req: Y

8887-42 — Price: \$2034

Dining Table

Collection: WESTWOOD

Dimensions: 42w × 42d × 36h Weight: 189 / 189 lbs Cube: 36.75

Standard Finish: Graphite Apron Height: N/A

Materials: Red Oak Solids and Veneers, High Pressure Laminate

Highlight Striping: N/A Contrasting Finishes or Paints: N/A

Conversion Varnish: N/A Paint Match: N/A

Features 8164-CB Counter Height base in Graphite finish, paired with 421S-42 Top. 42" square in Heathered Gray Finish with reversed beveled edge.

Country: CHINA Assembly Req: Y

8888-42 — Price: \$2184

Dining Table

Collection: WESTWOOD

Dimensions: 42w × 42d × 36h Weight: 258 / 258 lbs Cube: 36.75

Standard Finish: Graphite Apron Height: N/A

Materials: Red Oak Solids and Veneers, High Pressure Laminate

Highlight Striping: N/A Contrasting Finishes or Paints: N/A

Conversion Varnish: N/A Paint Match: N/A

Features 8164-CB Counter Height base in Graphite finish, paired with 4443-TP Top. 42" square in Perfect Walnut Finish with eased edge.

Country: CHINA Assembly Req: Y

8889-42 — Price: \$2184

Dining Table

Collection: WESTWOOD

Dimensions: 42w × 42d × 36h Weight: 258 / 258 lbs Cube: 36.75

Standard Finish: Graphite Apron Height: N/A

Materials: Red Oak Solids and Veneers, High Pressure Laminate

Highlight Striping: N/A Contrasting Finishes or Paints: N/A

Conversion Varnish: N/A Paint Match: N/A

Features 8164-CB Counter Height base in Graphite finish, paired with 4442-TP Top. 42" square in Coal Finish with eased edge.

Country: CHINA Assembly Req: Y

8890-42 — Price: \$1944

Dining Table

Collection: PROVENCE

Dimensions: 42w × 42d × 30h Weight: 189 / 189 lbs Cube: 30.62

Standard Finish: Sandstone Apron Height: N/A

Materials: Red Oak Solids and Veneers, High Pressure Laminate

Highlight Striping: N/A Contrasting Finishes or Paints: N/A

Conversion Varnish: N/A Paint Match: N/A

Features 8119-16 Dining Height base in Sandstone finish, paired with 425S-42 Top. 42" square top in Midnight Finish with reversed beveled edge.

Country: CHINA Assembly Req: Y

Casegoods

8891-42 — Price: \$1944

Dining Table

Collection: PROVENCE

Dimensions: 42w × 42d × 30h Weight: 189 / 189 lbs Cube: 30.62

Standard Finish: Sandstone Apron Height: N/A

Materials: Red Oak Solids and Veneers, High Pressure Laminate

Highlight Striping: N/A

Contrasting Finishes or Paints: N/A

Conversion Varnish: N/A

Paint Match: N/A

Features 8119-16 Dining Height base in Sandstone finish, paired with 421S-42 Top. 42" square in Heathered Gray Finish with reversed beveled edge.

Country: CHINA Assembly Req: Y

8892-42 — Price: \$2094

Dining Table

Collection: PROVENCE

Dimensions: 42w × 42d × 30h Weight: 258 / 258 lbs Cube: 30.62

Standard Finish: Sandstone Apron Height: N/A

Materials: Red Oak Solids and Veneers, High Pressure Laminate

Highlight Striping: N/A

Contrasting Finishes or Paints: N/A

Conversion Varnish: N/A

Paint Match: N/A

Features 8119-16 Dining Height base in Sandstone finish, paired with 4443-TP Top. 42" square in Perfect Walnut Finish with eased edge.

Country: CHINA Assembly Req: Y

8893-42 — Price: \$2094

Dining Table

Collection: PROVENCE

Dimensions: 42w × 42d × 30h Weight: 258 / 258 lbs Cube: 30.62

Standard Finish: Sandstone Apron Height: N/A

Materials: Red Oak Solids and Veneers, High Pressure Laminate

Highlight Striping: N/A

Contrasting Finishes or Paints: N/A

Conversion Varnish: N/A

Paint Match: N/A

Features 8119-16 Dining Height base in Sandstone finish, paired with 4442-TP Top. 42" square in Coal Finish with eased edge.

Country: CHINA Assembly Req: Y

8894-42 — Price: \$2034

Counter Height Table

Collection: PROVENCE

Dimensions: 42w × 42d × 36h Weight: 189 / 189 lbs Cube: 36.75

Standard Finish: Sandstone Apron Height: N/A

Materials: Red Oak Solids and Veneers, High Pressure Laminate

Highlight Striping: N/A

Contrasting Finishes or Paints: N/A

Conversion Varnish: N/A

Paint Match: N/A

Features 8119-CB Counter Height base in Sandstone finish, paired with 425S-42 Top. 42" square top in Midnight Finish with reversed beveled edge.

Country: CHINA Assembly Req: Y

8895-42 — Price: \$2034

Counter Height Table

Collection: PROVENCE

Dimensions: 42w × 42d × 36h Weight: 189 / 189 lbs Cube: 36.75

Standard Finish: Sandstone Apron Height: N/A

Materials: Red Oak Solids and Veneers, High Pressure Laminate

Highlight Striping: N/A

Contrasting Finishes or Paints: N/A

Conversion Varnish: N/A

Paint Match: N/A

Features 8119-CB Counter Height base in Sandstone finish, paired with 421S-42 Top. 42" square in Heathered Gray Finish with reversed beveled edge.

Country: CHINA Assembly Req: Y

8896-42 — Price: \$2184

Counter Height Table

Collection: PROVENCE

Dimensions: 42w × 42d × 36h Weight: 258 / 258 lbs Cube: 36.75

Standard Finish: Sandstone Apron Height: N/A

Materials: Red Oak Solids and Veneers, High Pressure Laminate

Highlight Striping: N/A

Contrasting Finishes or Paints: N/A

Conversion Varnish: N/A

Paint Match: N/A

Features 8119-CB Counter Height base in Sandstone finish, paired with 4443-TP Top. 42" square in Perfect Walnut Finish with eased edge.

Country: CHINA Assembly Req: Y

8897-42 — Price: \$2184

Counter Height Table

Collection: PROVENCE

Dimensions: 42w × 42d × 36h Weight: 258 / 258 lbs Cube: 36.75

Standard Finish: Sandstone Apron Height: N/A

Materials: Red Oak Solids and Veneers, High Pressure Laminate

Highlight Striping: N/A

Contrasting Finishes or Paints: N/A

Conversion Varnish: N/A

Paint Match: N/A

Features 8119-CB Counter Height base in Sandstone finish, paired with 4442-TP Top. 42" square in Coal Finish with eased edge.

Country: CHINA Assembly Req: Y

421R-26 — Price: \$687

Laminate 26" Round Table Top

Collection: MASSIMO

Dimensions: 26w × 26d × 1.25h Weight: 55 / 55 lbs Cube: 0.48

Standard Finish: Apron Height: N/A

Materials: High Pressure Laminate

Highlight Striping: N/A

Contrasting Finishes or Paints: N/A

Conversion Varnish: N/A

Paint Match: N/A

Features Reversed Beveled Edge Detail. Heathered Gray finish.

Country: CHINA Assembly Req: Y

Casegoods

421R-36 — Price: \$597

Laminate 36" Round Table Top

Collection: MASSIMO

Dimensions: 36w × 36d × 1.25h Weight: 44 / 44 lbs Cube: 3.52

Standard Finish: Apron Height: N/A

Materials: High Pressure Laminate

Highlight Striping: N/A

Contrasting Finishes or Paints: N/A

Conversion Varnish: N/A

Paint Match: N/A

Features Reversed Beveled Edge Detail. Heathered Gray finish

Country: CHINA Assembly Req: Y

421S-42 — Price: \$747

Laminate 42" Square Table Top

Collection: MASSIMO

Dimensions: 42w × 42d × 1.25h Weight: 53 / 53 lbs Cube: 4.68

Standard Finish: Apron Height: N/A

Materials: High Pressure Laminate

Highlight Striping: N/A

Contrasting Finishes or Paints: N/A

Conversion Varnish: N/A

Paint Match: N/A

Features Reversed Beveled Edge Detail. Heathered Gray finish

Country: CHINA Assembly Req: Y

421V-60 — Price: \$837

Laminate 60" Oval Table Top

Collection: MASSIMO

Dimensions: 60w × 30d × 1.25h Weight: 62 / 62 lbs Cube: 4.97

Standard Finish: Apron Height: N/A

Materials: High Pressure Laminate

Highlight Striping: N/A

Contrasting Finishes or Paints: N/A

Conversion Varnish: N/A

Paint Match: N/A

Features Reversed Beveled Edge Detail. Heathered Gray finish

Country: CHINA Assembly Req: Y

425R-26 — Price: \$687

Laminate 26" Round Table Top

Collection: MASSIMO

Dimensions: 26w × 26d × 1.25h Weight: 55 / 55 lbs Cube: 0.48

Standard Finish: Apron Height: N/A

Materials: High Pressure Laminate

Highlight Striping: N/A

Contrasting Finishes or Paints: N/A

Conversion Varnish: N/A

Paint Match: N/A

Features Reversed Beveled Edge Detail. Midnight finish.

Country: CHINA Assembly Req: Y

425R-36 — Price: \$597

Laminate 36" Round Table Top

Collection: MASSIMO

Dimensions: 36w × 36d × 1.25h Weight: 44 / 44 lbs Cube: 3.52

Standard Finish: Apron Height: N/A

Materials: High Pressure Laminate

Highlight Striping: N/A

Contrasting Finishes or Paints: N/A

Conversion Varnish: N/A

Paint Match: N/A

Features Reversed Beveled Edge Detail. Midnight finish

Country: CHINA Assembly Req: Y

425S-42 — Price: \$747

Laminate 42" Square Table Top

Collection: MASSIMO

Dimensions: 42w × 42d × 1.25h Weight: 53 / 53 lbs Cube: 4.68

Standard Finish: Apron Height: N/A

Materials: High Pressure Laminate

Highlight Striping: N/A

Contrasting Finishes or Paints: N/A

Conversion Varnish: N/A

Paint Match: N/A

Features Reversed Beveled Edge Detail. Midnight finish

Country: CHINA Assembly Req: Y

425V-60 — Price: \$837

Laminate 60" Oval Table Top

Collection: MASSIMO

Dimensions: 60w × 30d × 1.25h Weight: 62 / 62 lbs Cube: 4.97

Standard Finish: Apron Height: N/A

Materials: High Pressure Laminate

Highlight Striping: N/A

Contrasting Finishes or Paints: N/A

Conversion Varnish: N/A

Paint Match: N/A

Features Reversed Beveled Edge Detail. Midnight finish

Country: CHINA Assembly Req: Y

471R-42 — Price: \$747

Crescent 42" Round Table Top

Collection: CRESCENT, LAMINATE TABLE TOP AND BASE

Dimensions: 42w × 42d × 1.5h Weight: 60 / 60 lbs Cube: 4.34

Standard Finish: Graystone Apron Height: N/A

Materials: High Pressured Laminate with solid wood

Highlight Striping: N/A

Contrasting Finishes or Paints: N/A

Conversion Varnish: N/A

Paint Match: N/A

Commercial grade laminate in Graystone finish.

Country: CHINA Assembly Req: Y

Casegoods

471R-48 — Price: \$837

Crescent 48" Round Table Top

Collection: CRESCENT, LAMINATE TABLE TOP AND BASE

Dimensions: 48w × 48d × 1.5h Weight: 75 / 75 lbs Cube: 5.58

Standard Finish: Graystone Apron Height: N/A

Materials: High Pressured Laminate with solid wood

Highlight Striping: N/A

Contrasting Finishes or Paints: N/A

Conversion Varnish: N/A

Paint Match: N/A

Commercial grade laminate in Graystone finish.

Country: CHINA Assembly Req: Y

471S-48 — Price: \$837

Crescent 48" Square Table Top

Collection: CRESCENT, LAMINATE TABLE TOP AND BASE

Dimensions: 48w × 28.5d × 1.5h Weight: 96 / 96 lbs Cube: 5.58

Standard Finish: Graystone Apron Height: N/A

Materials: High Pressured Laminate with solid wood

Highlight Striping: N/A

Contrasting Finishes or Paints: N/A

Conversion Varnish: N/A

Paint Match: N/A

Commercial grade laminate in Graystone finish.

Country: CHINA Assembly Req: Y

472R-42 — Price: \$777

Crescent 42" Round Table Top

Collection: CRESCENT, LAMINATE TABLE TOP AND BASE

Dimensions: 42w × 42d × 1.25h Weight: 60 / 60 lbs Cube: 4.39

Standard Finish: Cherry Apron Height: N/A

Materials: High Pressured Laminate with solid wood

Highlight Striping: N/A

Contrasting Finishes or Paints: N/A

Conversion Varnish: N/A

Paint Match: N/A

Commercial grade laminate in Cherry finish.

Country: CHINA Assembly Req: Y

473R-48 — Price: \$987

McDonald 48" Round Table Top

Collection: MCDONALD, LAMINATE TABLE TOP AND BASE

Dimensions: 48w × 48d × 1.75h Weight: 65 / 65 lbs Cube: 5.11

Standard Finish: Walnut Apron Height: N/A

Materials: High Pressured Laminate with solid wood

Highlight Striping: N/A

Contrasting Finishes or Paints: N/A

Conversion Varnish: N/A

Paint Match: N/A

Commercial grade laminate in Walnut finish.

Country: CHINA Assembly Req: Y

473S-36 — Price: \$807

McDonald 36" Square Table Top

Collection: MCDONALD, LAMINATE TABLE TOP AND BASE

Dimensions: 36w × 36d × 1.75h Weight: 45 / 45 lbs Cube: 3.21

Standard Finish: Walnut Apron Height: N/A

Materials: High Pressured Laminate with solid wood

Highlight Striping: N/A

Contrasting Finishes or Paints: N/A

Conversion Varnish: N/A

Paint Match: N/A

Commercial grade laminate in Walnut finish.

Country: CHINA Assembly Req: Y

473S-48 — Price: \$987

McDonald 48" Square Table Top

Collection: MCDONALD, LAMINATE TABLE TOP AND BASE

Dimensions: 48w × 48d × 1.75h Weight: 96 / 96 lbs Cube: 5.53

Standard Finish: Walnut Apron Height: N/A

Materials: High Pressured Laminate with solid wood

Highlight Striping: N/A

Contrasting Finishes or Paints: N/A

Conversion Varnish: N/A

Paint Match: N/A

Commercial grade laminate in Walnut finish.

Country: CHINA Assembly Req: Y

476R-42 — Price: \$867

42" Round Table Top

Collection: LAMINATE TABLE TOP AND BASE

Dimensions: 42w × 42d × 1.75h Weight: 55 / 55 lbs Cube: 3.39

Standard Finish: Light Cherry Apron Height: N/A

Materials: High Pressured Laminate with solid wood

Highlight Striping: N/A

Contrasting Finishes or Paints: N/A

Conversion Varnish: N/A

Paint Match: N/A

Commercial grade laminate in Light Cherry finish.

Country: CHINA Assembly Req: Y

476S-36 — Price: \$807

36" Square Table Top

Collection: LAMINATE TABLE TOP AND BASE

Dimensions: 36w × 36d × 1.75h Weight: 45 / 45 lbs Cube: 2.54

Standard Finish: Light Cherry Apron Height: N/A

Materials: High Pressured Laminate with solid wood

Highlight Striping: N/A

Contrasting Finishes or Paints: N/A

Conversion Varnish: N/A

Paint Match: N/A

Commercial grade laminate in Light Cherry finish.

Country: CHINA Assembly Req: Y

Casegoods

476S-42 — Price: \$867

42" Square Table Top

Collection: LAMINATE TABLE TOP AND BASE

Dimensions: 42w × 42d × 1.75h Weight: 60 / 60 lbs Cube: 3.39

Standard Finish: Light Cherry Apron Height: N/A

Materials: High Pressured Laminate with solid wood

Highlight Striping: N/A

Contrasting Finishes or Paints: N/A

Conversion Varnish: N/A

Paint Match: N/A

Commercial grade laminate in Light Cherry finish.

Country: CHINA Assembly Req: Y

476S-48 — Price: \$927

48" Square Table Top

Collection: LAMINATE TABLE TOP AND BASE

Dimensions: 48w × 48d × 1.75h Weight: 85 / 85 lbs Cube: 4.36

Standard Finish: Light Cherry Apron Height: N/A

Materials: High Pressured Laminate with solid wood

Highlight Striping: N/A

Contrasting Finishes or Paints: N/A

Conversion Varnish: N/A

Paint Match: N/A

Commercial grade laminate in Light Cherry finish.

Country: CHINA Assembly Req: Y

477R-48 — Price: \$927

Campaigna 48" Round Table Top

Collection: CAMPAIGNA, LAMINATE TABLE TOP AND BASE

Dimensions: 48w × 48d × 1.75h Weight: 65 / 65 lbs Cube: 4.36

Standard Finish: Cafe Mocha Apron Height: N/A

Materials: High Pressured Laminate with solid wood

Highlight Striping: N/A

Contrasting Finishes or Paints: N/A

Conversion Varnish: N/A

Paint Match: N/A

Commercial grade laminate in Café Mocha finish.

Country: CHINA Assembly Req: Y

478R-42 — Price: \$747

42" Round Table Top

Collection: LAMINATE TABLE TOP AND BASE

Dimensions: 42w × 42d × 1.75h Weight: 50 / 50 lbs Cube: 4.59

Standard Finish: Sable Apron Height: N/A

Materials: High Pressured Laminate with solid wood

Highlight Striping: N/A

Contrasting Finishes or Paints: N/A

Conversion Varnish: N/A

Paint Match: N/A

Commercial grade laminate in Sable finish.

Country: CHINA Assembly Req: Y

478S-48 — Price: \$807

48" Square Table Top

Collection: LAMINATE TABLE TOP AND BASE

Dimensions: 48w × 48d × 1.75h Weight: 75 / 75 lbs Cube: 5.06

Standard Finish: Sable Apron Height: N/A

Materials: High Pressured Laminate with solid wood

Highlight Striping: N/A

Contrasting Finishes or Paints: N/A

Conversion Varnish: N/A

Paint Match: N/A

Commercial grade laminate in Sable finish.

Country: CHINA Assembly Req: Y

479R-48 — Price: \$807

Crescent 48" Round Table Top

Collection: CRESCENT, LAMINATE TABLE TOP AND BASE

Dimensions: 48w × 48d × 1.5h Weight: 73 / 73 lbs Cube: 6.02

Standard Finish: Suede Apron Height: N/A

Materials: High Pressured Laminate with solid wood

Highlight Striping: N/A

Contrasting Finishes or Paints: N/A

Conversion Varnish: N/A

Paint Match: N/A

Commercial grade laminate in Suede finish.

Country: CHINA Assembly Req: Y

479S-42 — Price: \$747

Crescent 42" Square Table Top

Collection: CRESCENT, LAMINATE TABLE TOP AND BASE

Dimensions: 42w × 42d × 1.5h Weight: 69 / 69 lbs Cube: 4.68

Standard Finish: Suede Apron Height: N/A

Materials: High Pressured Laminate with solid wood

Highlight Striping: N/A

Contrasting Finishes or Paints: N/A

Conversion Varnish: N/A

Paint Match: N/A

Commercial grade laminate in Suede finish.

Country: CHINA Assembly Req: Y

479S-48 — Price: \$807

Crescent 48" Square Table Top

Collection: CRESCENT, LAMINATE TABLE TOP AND BASE

Dimensions: 48w × 48d × 1.5h Weight: 89 / 89 lbs Cube: 6.02

Standard Finish: Suede Apron Height: N/A

Materials: High Pressured Laminate with solid wood

Highlight Striping: N/A

Contrasting Finishes or Paints: N/A

Conversion Varnish: N/A

Paint Match: N/A

Commercial grade laminate in Suede finish.

Country: CHINA Assembly Req: Y

Casegoods

813R-48 — Price: \$1017

Rustique 48" Table Top

Collection: RUSTIQUE

Dimensions: 48w × 48d × 2.5h Weight: 73 / 73 lbs Cube: 6.57

Standard Finish: Rustique Apron Height: N/A

Materials: Quartered Elm & Solids, Ash Solids & Veneers

Highlight Striping: N/A

Contrasting Finishes or Paints: N/A

Conversion Varnish: +\$450

Paint Match: +\$254

Rustic Elegance with hand wire brushing, creates deep finish characteristics

Country: CHINA Assembly Req: Y

813R-60 — Price: \$1497

Rustique 60" Table Top

Collection: RUSTIQUE

Dimensions: 60w × 60d × 2.5h Weight: 135 / 135 lbs Cube: 10.01

Standard Finish: Rustique Apron Height: N/A

Materials: Quartered Elm & Solids, Ash Solids & Veneers

Highlight Striping: N/A

Contrasting Finishes or Paints: N/A

Conversion Varnish: +\$450

Paint Match: +\$374

Rustic Elegance with hand wire brushing, creates deep finish characteristics

Country: CHINA Assembly Req: Y

827R-48 — Price: \$987

Nottingham Cottage Round Table Top

Collection: NOTTINGTON COTTAGE

Dimensions: 48w × 48d × 2.5h Weight: 80 / 80 lbs Cube: 6.51

Standard Finish: Antique Parchment Apron Height: N/A

Materials: Birch Solids & Veneers

Highlight Striping: N/A

Contrasting Finishes or Paints: N/A

Conversion Varnish: +\$450

Paint Match: +\$247

48" round top in an Antique Parchment finish. Pairs with 8127-TB, Nottingham Cottage Table Base.

Country: CHINA Assembly Req: Y

BE09-DT-A — Price: \$14997

Blonde Crotch Cut Walnut 109" Rectangular River Table Top

Collection: LIVE EDGE

Dimensions: 109w × 46d × 2h Weight: 200 / 200 lbs Cube: 5.8

Standard Finish: Arctic Resin Apron Height: N/A

Materials: Crotch Walnut, Resin

Highlight Striping: N/A

Contrasting Finishes or Paints: N/A

Conversion Varnish: +\$2250

Paint Match: N/A

Country: USA Assembly Req: Y

Also Available:

BE09-DT in Blonde Walnut at \$6147

BE09-DT-R in Graphite Resin at \$14997

BE09-DT-R — Price: \$14997

Blonde Crotch Cut Walnut 109" Rectangular River Table Top

Collection: LIVE EDGE

Dimensions: 109w × 46d × 2h Weight: 200 / 200 lbs Cube: 5.8

Standard Finish: Graphite Resin Apron Height: N/A

Materials: Crotch Walnut, Resin

Highlight Striping: N/A

Contrasting Finishes or Paints: N/A

Conversion Varnish: +\$2250

Paint Match: N/A

Country: USA Assembly Req: Y

Also Available:

BE09-DT in Blonde Walnut at \$6147

BE09-DT-A in Arctic Resin at \$14997

BE09-DT — Price: \$6147

Blonde Crotch Cut Walnut 109" Rectangular Table Top

Collection: LIVE EDGE

Dimensions: 109w × 46d × 2h Weight: 200 / 200 lbs Cube: 5.8

Standard Finish: Blonde Walnut Apron Height: N/A

Materials: Crotch Walnut

Highlight Striping: N/A

Contrasting Finishes or Paints: N/A

Conversion Varnish: +\$922

Paint Match: N/A

Country: USA Assembly Req: Y

Also Available:

BE09-DT-A in Arctic Resin at \$14997

BE09-DT-R in Graphite Resin at \$14997

T-BE54-WD — Price: \$4797

Blonde Crotch Cut Walnut 54" Waterfall Desk

Collection: LIVE EDGE

Dimensions: 54w × 0d × 30h Weight: 210 / 210 lbs Cube: 48.86

Standard Finish: Blonde Walnut Apron Height: N/A

Materials: Crotch Walnut & Metal

Highlight Striping: N/A

Contrasting Finishes or Paints: N/A

Conversion Varnish: +\$720

Paint Match: N/A

Natural American Walnut with a trapezoid metal base finished in Bronze.

Country: USA Assembly Req: Y

BE54-WD — Price: \$4947

Blonde Crotch Cut Walnut 54" Waterfall Desk

Collection: LIVE EDGE

Dimensions: 54w × 46d × 30h Weight: 210 / 210 lbs Cube: 48.86

Standard Finish: Blonde Walnut Apron Height: N/A

Materials: Crotch Walnut & Acrylic

Highlight Striping: N/A

Contrasting Finishes or Paints: N/A

Conversion Varnish: +\$742

Paint Match: N/A

Natural American Walnut with acrylic square base

Country: USA Assembly Req: Y

Casegoods

BE64-TP — Price: \$2187

Blonde Crotch Cut Walnut 64" Table Top

Collection: LIVE EDGE

Dimensions: 64w × 18d × 2h Weight: 57 / 57 lbs Cube: 4.27

Standard Finish: Blonde Walnut Apron Height: N/A

Materials: Crotch Walnut

Highlight Striping: N/A

Contrasting Finishes or Paints: N/A

Conversion Varnish: +\$450

Paint Match: N/A

Country: USA Assembly Req: Y

BE72-BT — Price: \$3597

Blonde Crotch Cut Walnut 72" Rectangular Table Top

Collection: LIVE EDGE

Dimensions: 72w × 46d × 2h Weight: 97 / 97 lbs Cube: 9.57

Standard Finish: Blonde Walnut Apron Height: N/A

Materials: Crotch Walnut

Highlight Striping: N/A

Contrasting Finishes or Paints: N/A

Conversion Varnish: +\$540

Paint Match: N/A

Country: USA Assembly Req: Y

BE84-DT-A — Price: \$12897

Blonde Crotch Cut Walnut 84" Rectangular River Table Top

Collection: LIVE EDGE

Dimensions: 84w × 46d × 2h Weight: 150 / 150 lbs Cube: 4.47

Standard Finish: Arctic Resin Apron Height: N/A

Materials: Crotch Walnut, Resin

Highlight Striping: N/A

Contrasting Finishes or Paints: N/A

Conversion Varnish: +\$1935

Paint Match: N/A

Country: USA Assembly Req: Y

Also Available:

BE84-DT in Blonde Walnut at \$4887

BE84-DT-R in Graphite Resin at \$12897

BE84-DT-R — Price: \$12897

Blonde Crotch Cut Walnut 84" Rectangular River Table Top

Collection: LIVE EDGE

Dimensions: 84w × 46d × 2h Weight: 150 / 150 lbs Cube: 4.47

Standard Finish: Graphite Resin Apron Height: N/A

Materials: Crotch Walnut, Resin

Highlight Striping: N/A

Contrasting Finishes or Paints: N/A

Conversion Varnish: +\$1935

Paint Match: N/A

Country: USA Assembly Req: Y

Also Available:

BE84-DT in Blonde Walnut at \$4887

BE84-DT-A in Blonde Walnut at \$12897

BE84-DT — Price: \$4887

Blonde Crotch Cut Walnut 84" Rectangular Table Top

Collection: LIVE EDGE

Dimensions: 84w × 46d × 2h Weight: 150 / 150 lbs Cube: 4.47

Standard Finish: Blonde Walnut Apron Height: N/A

Materials: Crotch Walnut

Highlight Striping: N/A

Contrasting Finishes or Paints: N/A

Conversion Varnish: +\$733

Paint Match: N/A

Country: USA Assembly Req: Y

Also Available:

BE84-DT-A in Arctic Resin at \$12897

BE84-DT-R in Graphite Resin at \$12897

CAR1-40 — Price: \$4647

Day Tripper Repurposed Car Settee

Collection:

Dimensions: 68w × 32d × 34h Weight: 176 / 176 lbs Cube: 55.51

Standard Finish: Apron Height: N/A

Materials:

Highlight Striping: N/A

Contrasting Finishes or Paints: N/A

Conversion Varnish: N/A

Paint Match: N/A

Features leather racing seats with working headlights.

Country: INDIA Assembly Req: N

CW09-DT-A — Price: \$13497

Crotch Cut Walnut 109" Rectangular River Table Top

Collection: LIVE EDGE

Dimensions: 109w × 46d × 2h Weight: 200 / 200 lbs Cube: 5.8

Standard Finish: Arctic Resin Apron Height: N/A

Materials: Crotch Walnut Solids, Epoxy Resin

Highlight Striping: N/A

Contrasting Finishes or Paints: N/A

Conversion Varnish: +\$2025

Paint Match: N/A

Country: USA Assembly Req: Y

Also Available:

CW09-DT in Natural at \$6597

CW09-DT-R in Graphite Resin at \$13497

CW09-DT-R — Price: \$13497

Crotch Cut Walnut 109" Rectangular River Table Top

Collection: LIVE EDGE

Dimensions: 109w × 46d × 2h Weight: 200 / 200 lbs Cube: 16.75

Standard Finish: Graphite Resin Apron Height: N/A

Materials: Crotch Walnut, Epoxy Resin

Highlight Striping: N/A

Contrasting Finishes or Paints: N/A

Conversion Varnish: +\$2025

Paint Match: N/A

Natural American Walnut.

Country: USA Assembly Req: Y

Also Available:

CW09-DT in Natural at \$6597

CW09-DT-A in Arctic Resin at \$13497

Casegoods

CW09-DT — Price: \$6597

Crotch Cut Walnut 109" Rectangular Table Top

Collection: LIVE EDGE

Dimensions: 109w × 46d × 2h Weight: 200 / 200 lbs Cube: 16.75

Standard Finish: Natural Apron Height: N/A

Materials: Crotch Walnut

Highlight Striping: N/A

Contrasting Finishes or Paints: N/A

Conversion Varnish: +\$990

Paint Match: N/A

Natural American Walnut.

Country: USA Assembly Req: Y

Also Available:

CW09-DT-A in Arctic Resin at \$13497

CW09-DT-R in Graphite Resin at \$13497

CW54-DK — Price: \$3897

Crotch Cut Walnut 54" Desk Top

Collection: LIVE EDGE

Dimensions: 54w × 0d × 2h Weight: 155 / 155 lbs Cube: 5.77

Standard Finish: Natural Apron Height: N/A

Materials: Crotch Walnut

Highlight Striping: N/A

Contrasting Finishes or Paints: N/A

Conversion Varnish: +\$585

Paint Match: N/A

Natural American Walnut.

Country: USA Assembly Req: Y

T-CW54-WC — Price: \$4377

Crotch Cut Walnut 54" Waterfall Cocktail Table

Collection: LIVE EDGE

Dimensions: 54w × 0d × 18h Weight: 102 / 102 lbs Cube: 26.57

Standard Finish: Natural Apron Height: N/A

Materials: Crotch Walnut

Highlight Striping: N/A

Contrasting Finishes or Paints: N/A

Conversion Varnish: +\$657

Paint Match: N/A

Natural American Walnut with a trapezoid metal base finished in Bronze.

Country: USA Assembly Req: N

CW54-WC — Price: \$4467

Crotch Cut Walnut 54" Waterfall Cocktail Table

Collection: LIVE EDGE

Dimensions: 54w × 0d × 18h Weight: 119 / 119 lbs Cube: 30.83

Standard Finish: Natural Apron Height: N/A

Materials: Crotch Walnut & Acrylic

Highlight Striping: N/A

Contrasting Finishes or Paints: N/A

Conversion Varnish: +\$670

Paint Match: N/A

Natural American Walnut with acrylic square base.

Country: USA Assembly Req: Y

T-CW54-WD — Price: \$5037

Crotch Cut Walnut 54" Waterfall Desk

Collection: LIVE EDGE

Dimensions: 54w × 0d × 30h Weight: 155 / 155 lbs Cube: 48.86

Standard Finish: Natural Apron Height: N/A

Materials: Crotch Walnut

Highlight Striping: N/A

Contrasting Finishes or Paints: N/A

Conversion Varnish: +\$756

Paint Match: N/A

Natural American Walnut with a trapezoid metal base finished in Bronze.

Country: USA Assembly Req: N

CW54-WD — Price: \$5277

Crotch Cut Walnut 54" Waterfall Desk

Collection: LIVE EDGE

Dimensions: 54w × 0d × 30h Weight: 155 / 155 lbs Cube: 48.86

Standard Finish: Natural Apron Height: N/A

Materials: Crotch Walnut & Acrylic

Highlight Striping: N/A

Contrasting Finishes or Paints: N/A

Conversion Varnish: +\$792

Paint Match: N/A

Natural American Walnut with acrylic square base.

Country: USA Assembly Req: Y

CW56-96 — Price: \$3627

Crotch Cut Walnut Console Table

Collection: LIVE EDGE

Dimensions: 56w × 20d × 36h Weight: 134 / 134 lbs Cube: 26.03

Standard Finish: Natural Apron Height: N/A

Materials: Crotch Walnut & Metal

Highlight Striping: N/A

Contrasting Finishes or Paints: N/A

Conversion Varnish: +\$544

Paint Match: N/A

Natural American Walnut Stretcher, Black Nickel finish on a Stainless Steel Base with a 3/4" tempered glass top.

Country: CHINA Assembly Req: N

CW64-TP — Price: \$2307

Crotch Cut Walnut 64" Rectangular Table Top

Collection: LIVE EDGE

Dimensions: 64w × 18d × 2h Weight: 57 / 57 lbs Cube: 4.27

Standard Finish: Natural Apron Height: N/A

Materials: Crotch Walnut

Highlight Striping: N/A

Contrasting Finishes or Paints: N/A

Conversion Varnish: +\$450

Paint Match: N/A

Natural American Walnut.

Country: USA Assembly Req: Y

Casegoods

CW72-BT — Price: \$3807

Crotch Cut Walnut 72" Rectangular Table Top

Collection: LIVE EDGE

Dimensions: 72w × 0d × 2h Weight: 97 / 97 lbs Cube: 9.57

Standard Finish: Natural Apron Height: N/A

Materials: Crotch Walnut

Highlight Striping: N/A

Contrasting Finishes or Paints: N/A

Conversion Varnish: +\$571

Paint Match: N/A

Natural American Walnut.

Country: USA Assembly Req: Y

CW84-DT-A — Price: \$11397

Crotch Cut Walnut 84" Rectangular River Table Top

Collection: LIVE EDGE

Dimensions: 84w × 46d × 2h Weight: 150 / 150 lbs Cube: 4.47

Standard Finish: Arctic Resin Apron Height: N/A

Materials: Crotch Walnut Solids, Epoxy Resin

Highlight Striping: N/A

Contrasting Finishes or Paints: N/A

Conversion Varnish: +\$1710

Paint Match: N/A

Country: USA Assembly Req: Y

Also Available:

CW84-DT in Natural at \$5217

CW84-DT-R in Graphite Resin at \$11397

CW84-DT-R — Price: \$11397

Crotch Cut Walnut 84" Rectangular River Table Top

Collection: LIVE EDGE

Dimensions: 84w × 46d × 2h Weight: 150 / 150 lbs Cube: 13.41

Standard Finish: Graphite Resin Apron Height: N/A

Materials: Crotch Walnut, Epoxy Resin

Highlight Striping: N/A

Contrasting Finishes or Paints: N/A

Conversion Varnish: +\$1710

Paint Match: N/A

Natural American Walnut.

Country: USA Assembly Req: Y

Also Available:

CW84-DT in Natural at \$5217

CW84-DT-A in Arctic Resin at \$11397

CW84-DT — Price: \$5217

Crotch Cut Walnut 84" Rectangular Table Top

Collection: LIVE EDGE

Dimensions: 84w × 46d × 2h Weight: 150 / 150 lbs Cube: 13.41

Standard Finish: Natural Apron Height: N/A

Materials: Crotch Walnut

Highlight Striping: N/A

Contrasting Finishes or Paints: N/A

Conversion Varnish: +\$783

Paint Match: N/A

Natural American Walnut.

Country: USA Assembly Req: Y

Also Available:

CW84-DT-A in Arctic Resin at \$11397

CW84-DT-R in Graphite Resin at \$11397

GLAS-54 — Price: \$1197

54" Glass Top

Collection:

Dimensions: 54w × 54d × 0.5h Weight: 108 / 108 lbs Cube: 6.69

Standard Finish: Apron Height: N/A

Materials: Tempered Glass

Highlight Striping: N/A

Contrasting Finishes or Paints: N/A

Conversion Varnish: N/A

Paint Match: N/A

Ogee Edge

Country: CHINA Assembly Req: N

GLAS-60 — Price: \$1317

60" Glass Top

Collection:

Dimensions: 60w × 60d × 0.5h Weight: 136 / 136 lbs Cube: 8.42

Standard Finish: Apron Height: N/A

Materials: Tempered Glass

Highlight Striping: N/A

Contrasting Finishes or Paints: N/A

Conversion Varnish: N/A

Paint Match: N/A

Ogee Edge

Country: CHINA Assembly Req: N

HG09-DT — Price: \$8007

Heritage Guanacaste 109" Rectangular Table Top

Collection: LIVE EDGE

Dimensions: 109w × 0d × 2h Weight: 231 / 231 lbs Cube: 15.87

Standard Finish: Heritage Apron Height: N/A

Materials: Guanacaste

Highlight Striping: N/A

Contrasting Finishes or Paints: N/A

Conversion Varnish: +\$1201

Paint Match: N/A

Heritage stained Guanacaste.

Country: USA Assembly Req: Y

HG22-AT — Price: \$1707

Heritage Guanacaste 22" Round Table Top

Collection: LIVE EDGE

Dimensions: 22w × 22d × 2h Weight: 41 / 41 lbs Cube: 1.8

Standard Finish: Heritage Apron Height: N/A

Materials: Guanacaste

Highlight Striping: N/A

Contrasting Finishes or Paints: N/A

Conversion Varnish: +\$450

Paint Match: N/A

Heritage stained Guanacaste.

Country: USA Assembly Req: Y

Casegoods

HG22-ET — Price: \$1857

Heritage Guanacaste 22" Square Table Top

Collection: LIVE EDGE

Dimensions: 22w × 22d × 2h Weight: 38 / 38 lbs Cube: 1.8

Standard Finish: Heritage Apron Height: N/A

Materials: Guanacaste

Highlight Striping: N/A

Contrasting Finishes or Paints: N/A

Conversion Varnish: +\$450

Paint Match: N/A

Heritage stained Guanacaste.

Country: USA Assembly Req: Y

HG38-RT — Price: \$4047

Heritage Guanacaste 38" Round Table Top

Collection: LIVE EDGE

Dimensions: 38w × 0d × 2h Weight: 55 / 55 lbs Cube: 4.86

Standard Finish: Heritage Apron Height: N/A

Materials: Guanacaste

Highlight Striping: N/A

Contrasting Finishes or Paints: N/A

Conversion Varnish: +\$607

Paint Match: N/A

Heritage stained Guanacaste.

Country: USA Assembly Req: Y

HG48-CT — Price: \$3417

Heritage Guanacaste 48" Square Table Top

Collection: LIVE EDGE

Dimensions: 48w × 30d × 2h Weight: 76 / 76 lbs Cube: 7.87

Standard Finish: Heritage Apron Height: N/A

Materials: Guanacaste

Highlight Striping: N/A

Contrasting Finishes or Paints: N/A

Conversion Varnish: +\$513

Paint Match: N/A

Heritage stained Guanacaste.

Country: USA Assembly Req: Y

HG48-RT — Price: \$5787

Heritage Guanacaste 48" Round Table Top

Collection: LIVE EDGE

Dimensions: 48w × 48d × 2h Weight: 80 / 80 lbs Cube: 7.52

Standard Finish: Heritage Apron Height: N/A

Materials: Guanacaste

Highlight Striping: N/A

Contrasting Finishes or Paints: N/A

Conversion Varnish: +\$868

Paint Match: N/A

Heritage stained Guanacaste.

Country: USA Assembly Req: Y

HG54-DK — Price: \$4197

Heritage Guanacaste 54" Desk Top

Collection: LIVE EDGE

Dimensions: 54w × 0d × 2h Weight: 81 / 81 lbs Cube: 8.46

Standard Finish: Heritage Apron Height: N/A

Materials: Guanacaste

Highlight Striping: N/A

Contrasting Finishes or Paints: N/A

Conversion Varnish: +\$630

Paint Match: N/A

Heritage stained Guanacaste.

Country: USA Assembly Req: Y

HG54-RC — Price: \$3957

Heritage Guanacaste 54" Rectangular Table Top

Collection: LIVE EDGE

Dimensions: 54w × 0d × 2h Weight: 66 / 66 lbs Cube: 6.05

Standard Finish: Heritage Apron Height: N/A

Materials: Guanacaste

Highlight Striping: N/A

Contrasting Finishes or Paints: N/A

Conversion Varnish: +\$594

Paint Match: N/A

Heritage stained Guanacaste.

Country: USA Assembly Req: N

T-HG54-WC — Price: \$4647

Heritage Guanacaste 54" Waterfall Cocktail Table

Collection: LIVE EDGE

Dimensions: 54w × 0d × 18h Weight: 89 / 89 lbs Cube: 26.57

Standard Finish: Bronze Apron Height: N/A

Materials: Guanacaste

Highlight Striping: N/A

Contrasting Finishes or Paints: N/A

Conversion Varnish: +\$697

Paint Match: N/A

Heritage stained Guanacaste with a trapezoid metal base finished in Bronze.

Country: USA Assembly Req: N

HG54-WC — Price: \$4917

Heritage Guanacaste 54" Waterfall Cocktail Table

Collection: LIVE EDGE

Dimensions: 54w × 0d × 18h Weight: 119 / 119 lbs Cube: 30.83

Standard Finish: Heritage Apron Height: N/A

Materials: Guanacaste & Acrylic

Highlight Striping: N/A

Contrasting Finishes or Paints: N/A

Conversion Varnish: +\$738

Paint Match: N/A

Heritage stained Guanacaste with acrylic square base.

Country: USA Assembly Req: N

Casegoods

T-HG54-WD — Price: \$5787

Heritage Guanacaste 54" Waterfall Desk

Collection: LIVE EDGE

Dimensions: 54w × 0d × 30h Weight: 155 / 155 lbs Cube: 42.45

Standard Finish: Bronze Apron Height: N/A

Materials: Guanacaste

Highlight Striping: N/A

Contrasting Finishes or Paints: N/A

Conversion Varnish: +\$868

Paint Match: N/A

Heritage stained Guanacaste with a trapezoid metal base finished in Bronze.

Country: USA Assembly Req: N

HG54-WD — Price: \$5937

Heritage Guanacaste 54" Waterfall Desk

Collection: LIVE EDGE

Dimensions: 54w × 0d × 30h Weight: 155 / 155 lbs Cube: 48.76

Standard Finish: Heritage Apron Height: N/A

Materials: Guanacaste & Acrylic

Highlight Striping: N/A

Contrasting Finishes or Paints: N/A

Conversion Varnish: +\$891

Paint Match: N/A

Heritage stained Guanacaste with acrylic square base.

Country: USA Assembly Req: N

HG72-BT — Price: \$4197

Heritage Guanacaste 72" Rectangular Table Top

Collection: LIVE EDGE

Dimensions: 72w × 0d × 2h Weight: 0 / 0 lbs Cube: 9.57

Standard Finish: Heritage Apron Height: N/A

Materials: Guanacaste

Highlight Striping: N/A

Contrasting Finishes or Paints: N/A

Conversion Varnish: +\$630

Paint Match: N/A

Heritage stained Guanacaste.

Country: USA Assembly Req: Y

HG84-DT — Price: \$6297

Heritage Guanacaste 84" Rectangular Table Top

Collection: LIVE EDGE

Dimensions: 84w × 0d × 2h Weight: 142 / 142 lbs Cube: 13.35

Standard Finish: Heritage Apron Height: N/A

Materials: Guanacaste

Highlight Striping: N/A

Contrasting Finishes or Paints: N/A

Conversion Varnish: +\$945

Paint Match: N/A

Heritage stained Guanacaste.

Country: USA Assembly Req: Y

HP16-4B — Price: \$957

Four Hair Pin 16" Legs

Collection: LIVE EDGE

Dimensions: 4.5w × 4.5d × 16h Weight: 12 / 12 lbs Cube: 0.51

Standard Finish: Bronze Apron Height: N/A

Materials: Metal

Highlight Striping: N/A

Contrasting Finishes or Paints: N/A

Conversion Varnish: N/A

Paint Match: N/A

Set of four metal legs in Bronze finish.

Country: USA Assembly Req: Y

HP16-4G — Price: \$957

Four Hair Pin 16" Legs

Collection: LIVE EDGE

Dimensions: 4.5w × 4.5d × 16h Weight: 12 / 12 lbs Cube: 0.61

Standard Finish: Gold Apron Height: N/A

Materials: Metal

Highlight Striping: N/A

Contrasting Finishes or Paints: N/A

Conversion Varnish: N/A

Paint Match: N/A

Set of four metal legs in Gold finish.

Country: USA Assembly Req: Y

HP32-3B — Price: \$777

Three Hair Pin 16" Legs

Collection: LIVE EDGE

Dimensions: 4.5w × 4.5d × 32h Weight: 18 / 18 lbs Cube: 1.46

Standard Finish: Bronze Apron Height: N/A

Materials: Metal

Highlight Striping: N/A

Contrasting Finishes or Paints: N/A

Conversion Varnish: N/A

Paint Match: N/A

Set of three metal legs in Bronze finish.

Country: USA Assembly Req: Y

HP32-3G — Price: \$777

Three Hair Pin 32" Legs

Collection: LIVE EDGE

Dimensions: 4.5w × 4.5d × 32h Weight: 18 / 18 lbs Cube: 1.13

Standard Finish: Gold Apron Height: N/A

Materials: Metal

Highlight Striping: N/A

Contrasting Finishes or Paints: N/A

Conversion Varnish: N/A

Paint Match: N/A

Set of three metal legs in Gold finish.

Country: USA Assembly Req: Y

Casegoods

HP32-4B — Price: \$987

Four Hair Pin 32" Legs

Collection: LIVE EDGE

Dimensions: 4.5w × 4.5d × 32h Weight: 24 / 24 lbs Cube: 1.41

Standard Finish: Bronze Apron Height: N/A

Materials: Metal

Highlight Striping: N/A

Contrasting Finishes or Paints: N/A

Conversion Varnish: N/A

Paint Match: N/A

Set of four metal legs in Bronze finish.

Country: USA Assembly Req: Y

HP32-4G — Price: \$987

Hair Pin 32" Legs

Collection: LIVE EDGE

Dimensions: 4.5w × 4.5d × 32h Weight: 24 / 24 lbs Cube: 1.46

Standard Finish: Gold Apron Height: N/A

Materials: Metal

Highlight Striping: N/A

Contrasting Finishes or Paints: N/A

Conversion Varnish: N/A

Paint Match: N/A

Set of four metal legs in Gold finish.

Country: USA Assembly Req: Y

LE09-DT — Price: \$7197

Natural Guanacaste 109" Rectangular Table Top

Collection: LIVE EDGE

Dimensions: 109w × 0d × 2h Weight: 231 / 231 lbs Cube: 16.76

Standard Finish: Natural Apron Height: N/A

Materials: Guanacaste

Highlight Striping: N/A

Contrasting Finishes or Paints: N/A

Conversion Varnish: +\$1080

Paint Match: N/A

Natural Guanacaste

Country: USA Assembly Req: Y

LE14-AT — Price: \$957

Natural Guanacaste 14" Round Table Top

Collection: LIVE EDGE

Dimensions: 14w × 14d × 2.5h Weight: 18 / 18 lbs Cube: 3.07

Standard Finish: Natural Apron Height: N/A

Materials: Guanacaste

Highlight Striping: N/A

Contrasting Finishes or Paints: N/A

Conversion Varnish: +\$450

Paint Match: N/A

Natural Guanacaste

Country: USA Assembly Req: Y

LE16-3B — Price: \$597

Three Metal 16" Legs

Collection: LIVE EDGE

Dimensions: 0w × 0d × 16h Weight: 5 / 5 lbs Cube: 0.18

Standard Finish: Bronze Apron Height: N/A

Materials: Metal

Highlight Striping: N/A

Contrasting Finishes or Paints: N/A

Conversion Varnish: N/A

Paint Match: N/A

Three metal legs finished in Bronze.

Country: CHINA Assembly Req: Y

LE20-3B — Price: \$687

Three Metal 20" Legs

Collection: LIVE EDGE

Dimensions: 0w × 0d × 20h Weight: 7 / 7 lbs Cube: 0.22

Standard Finish: Bronze Apron Height: N/A

Materials: Metal

Highlight Striping: N/A

Contrasting Finishes or Paints: N/A

Conversion Varnish: N/A

Paint Match: N/A

Three metal legs finished in Bronze.

Country: CHINA Assembly Req: Y

LE20-3N — Price: \$687

Metal 20" Legs

Collection: LIVE EDGE

Dimensions: 0w × 0d × 20h Weight: 7 / 7 lbs Cube: 0.22

Standard Finish: Nickel Apron Height: N/A

Materials: Metal

Highlight Striping: N/A

Contrasting Finishes or Paints: N/A

Conversion Varnish: N/A

Paint Match: N/A

Three metal legs finished in Nickel.

Country: USA Assembly Req: Y

LE22-AT — Price: \$1647

Natural Guanacaste 22" Round Table Top

Collection: LIVE EDGE

Dimensions: 22w × 22d × 2h Weight: 41 / 41 lbs Cube: 3.76

Standard Finish: Natural Apron Height: N/A

Materials: Guanacaste

Highlight Striping: N/A

Contrasting Finishes or Paints: N/A

Conversion Varnish: +\$450

Paint Match: N/A

Natural Guanacaste

Country: USA Assembly Req: Y

Casegoods

LE22-ET — Price: \$1677

Natural Guanacaste 22" Square Table Top

Collection: LIVE EDGE

Dimensions: 22w × 22d × 2h Weight: 38 / 38 lbs Cube: 3.56

Standard Finish: Natural Apron Height: N/A

Materials: Guanacaste

Highlight Striping: N/A

Contrasting Finishes or Paints: N/A

Conversion Varnish: +\$450

Paint Match: N/A

Natural Guanacaste

Country: USA Assembly Req: Y

LE38-96 — Price: \$1827

Natural Guanacaste Demilune Top

Collection: LIVE EDGE

Dimensions: 36w × 18d × 2h Weight: 30 / 30 lbs Cube: 2.99

Standard Finish: Natural Apron Height: N/A

Materials: Guanacaste

Highlight Striping: N/A

Contrasting Finishes or Paints: N/A

Conversion Varnish: +\$450

Paint Match: N/A

Demilune shaped top in Natural Guanacaste.

Country: USA Assembly Req: Y

LE38-RT — Price: \$3717

Natural Guanacaste 38" Round Table Top

Collection: LIVE EDGE

Dimensions: 38w × 0d × 3h Weight: 55 / 55 lbs Cube: 6.51

Standard Finish: Natural Apron Height: N/A

Materials: Guanacaste

Highlight Striping: N/A

Contrasting Finishes or Paints: N/A

Conversion Varnish: +\$558

Paint Match: N/A

Natural Guanacaste

Country: USA Assembly Req: Y

LE38-SR — Price: \$3957

Natural Guanacaste 38" Diameter Two Piece Cocktail Table

Collection: LIVE EDGE

Dimensions: 38w × 38d × 2h Weight: 99 / 99 lbs Cube: 28.69

Standard Finish: Bronze Apron Height: N/A

Materials: Guanacaste & Metal

Highlight Striping: N/A

Contrasting Finishes or Paints: N/A

Conversion Varnish: +\$594

Paint Match: N/A

Split, round top in Natural Guanacaste with a metal base finished in Bronze.

Country: USA Assembly Req: N

LE48-CT — Price: \$3177

Natural Guanacaste 48" Square Table Top

Collection: LIVE EDGE

Dimensions: 48w × 30d × 2h Weight: 83 / 83 lbs Cube: 7.87

Standard Finish: Natural Apron Height: N/A

Materials: Guanacaste

Highlight Striping: N/A

Contrasting Finishes or Paints: N/A

Conversion Varnish: +\$477

Paint Match: N/A

Natural Guanacaste

Country: USA Assembly Req: Y

LE48-RT — Price: \$5607

Natural Guanacaste 48" Round Table Top

Collection: LIVE EDGE

Dimensions: 48w × 48d × 2h Weight: 80 / 80 lbs Cube: 6.38

Standard Finish: Natural Apron Height: N/A

Materials: Guanacaste

Highlight Striping: N/A

Contrasting Finishes or Paints: N/A

Conversion Varnish: +\$841

Paint Match: N/A

Natural Guanacaste

Country: USA Assembly Req: Y

LE54-DK — Price: \$3957

Natural Guanacaste 54" Desk Top

Collection: LIVE EDGE

Dimensions: 54w × 0d × 2h Weight: 81 / 81 lbs Cube: 5.77

Standard Finish: Natural Apron Height: N/A

Materials: Guanacaste

Highlight Striping: N/A

Contrasting Finishes or Paints: N/A

Conversion Varnish: +\$594

Paint Match: N/A

Natural Guanacaste

Country: USA Assembly Req: Y

LE54-RC — Price: \$3087

Natural Guanacaste 54" Rectangular Cocktail Table Top

Collection: LIVE EDGE

Dimensions: 54w × 0d × 2h Weight: 66 / 66 lbs Cube: 6.05

Standard Finish: Natural Apron Height: N/A

Materials: Guanacaste

Highlight Striping: N/A

Contrasting Finishes or Paints: N/A

Conversion Varnish: +\$463

Paint Match: N/A

Natural Guanacaste

Country: USA Assembly Req: Y

Casegoods

T-LE54-WC — Price: \$4377

Natural Guanacaste 54" Waterfall Cocktail Table

Collection: LIVE EDGE

Dimensions: 54w × 0d × 18h Weight: 102 / 102 lbs Cube: 26.57

Standard Finish: Natural Apron Height: N/A

Materials: Guanacaste

Highlight Striping: N/A

Contrasting Finishes or Paints: N/A

Conversion Varnish: +\$657

Paint Match: N/A

Natural Guanacaste with a trapezoid metal base finished in Bronze.

Country: USA Assembly Req: N

LE54-WC — Price: \$4467

Natural Guanacaste 54" Waterfall Cocktail Table

Collection: LIVE EDGE

Dimensions: 54w × 0d × 18h Weight: 119 / 119 lbs Cube: 30.83

Standard Finish: Natural Apron Height: N/A

Materials: Guanacaste

Highlight Striping: N/A

Contrasting Finishes or Paints: N/A

Conversion Varnish: +\$670

Paint Match: N/A

Natural Guanacaste with an acrylic square base.

Country: USA Assembly Req: N

T-LE54-WD — Price: \$5247

Natural Guanacaste 54" Waterfall Desk

Collection: LIVE EDGE

Dimensions: 54w × 0d × 30h Weight: 120 / 120 lbs Cube: 42.45

Standard Finish: Natural Apron Height: N/A

Materials: Guanacaste

Highlight Striping: N/A

Contrasting Finishes or Paints: N/A

Conversion Varnish: +\$787

Paint Match: N/A

Natural Guanacaste with a trapezoid metal base finished in Bronze.

Country: USA Assembly Req: N

LE54-WD — Price: \$5607

Natural Guanacaste 54" Waterfall Desk

Collection: LIVE EDGE

Dimensions: 54w × 0d × 30h Weight: 155 / 155 lbs Cube: 48.76

Standard Finish: Natural Apron Height: N/A

Materials: Guanacaste

Highlight Striping: N/A

Contrasting Finishes or Paints: N/A

Conversion Varnish: +\$841

Paint Match: N/A

Natural Guanacaste with an acrylic square base.

Country: USA Assembly Req: N

LE72-BT — Price: \$4107

Natural Guanacaste 72" Rectangular Table Top

Collection: LIVE EDGE

Dimensions: 72w × 0d × 2h Weight: 97 / 97 lbs Cube: 9.57

Standard Finish: Natural Apron Height: N/A

Materials: Guanacaste

Highlight Striping: N/A

Contrasting Finishes or Paints: N/A

Conversion Varnish: +\$616

Paint Match: N/A

Natural Guanacaste

Country: USA Assembly Req: Y

LE84-DT — Price: \$5817

Natural Guanacaste 84" Rectangular Table Top

Collection: LIVE EDGE

Dimensions: 84w × 0d × 2h Weight: 142 / 142 lbs Cube: 13.35

Standard Finish: Natural Apron Height: N/A

Materials: Guanacaste

Highlight Striping: N/A

Contrasting Finishes or Paints: N/A

Conversion Varnish: +\$873

Paint Match: N/A

Natural Guanacaste

Country: USA Assembly Req: Y

LEAS-BT — Price: \$1077

Acrylic Square Counter Height Base

Collection: LIVE EDGE

Dimensions: 20w × 2d × 34h Weight: 29 / 29 lbs Cube: 4.42

Standard Finish: Acrylic Apron Height: N/A

Materials: Acrylic

Highlight Striping: N/A

Contrasting Finishes or Paints: N/A

Conversion Varnish: N/A

Paint Match: N/A

This style is sold as one base. When pairing with our Live Edge tops two bases are required.

Country: CHINA Assembly Req: Y

LEAS-DT — Price: \$1047

Acrylic Square Dining Height Base

Collection: LIVE EDGE

Dimensions: 24w × 2d × 28h Weight: 32 / 32 lbs Cube: 4.36

Standard Finish: Acrylic Apron Height: N/A

Materials: Acrylic

Highlight Striping: N/A

Contrasting Finishes or Paints: N/A

Conversion Varnish: N/A

Paint Match: N/A

This style is sold as one base. When pairing with our Live Edge two bases are required.

Country: CHINA Assembly Req: Y

Casegoods

LEAS-PT — Price: \$1257

Acrylic Square Bar Height Base

Collection: LIVE EDGE

Dimensions: 20w × 2d × 38h Weight: 33 / 33 lbs Cube: 5.02

Standard Finish: Acrylic Apron Height: N/A

Materials: Acrylic

Highlight Striping: N/A

Contrasting Finishes or Paints: N/A

Conversion Varnish: N/A

Paint Match: N/A

This style is sold as one base. When pairing with our Live Edge two bases are required.

Country: CHINA Assembly Req: Y

LEAW-BT — Price: \$1107

Acrylic Wedge Counter Height Base

Collection: LIVE EDGE

Dimensions: 20w × 10d × 34h Weight: 37 / 37 lbs Cube: 8.07

Standard Finish: Acrylic Apron Height: N/A

Materials: Acrylic

Highlight Striping: N/A

Contrasting Finishes or Paints: N/A

Conversion Varnish: N/A

Paint Match: N/A

This style is sold as one base. When pairing with our Live Edge two bases are required.

Country: CHINA Assembly Req: Y

LEAW-DT — Price: \$1107

Acrylic Wedge Dining Height Base

Collection: LIVE EDGE

Dimensions: 24w × 12d × 28h Weight: 37 / 37 lbs Cube: 8.92

Standard Finish: Acrylic Apron Height: N/A

Materials: Acrylic

Highlight Striping: N/A

Contrasting Finishes or Paints: N/A

Conversion Varnish: N/A

Paint Match: N/A

This style is sold as one base. When pairing with our Live Edge two bases are required.

Country: CHINA Assembly Req: Y

LEAW-PT — Price: \$1167

Acrylic Wedge Bar Height Base

Collection: LIVE EDGE

Dimensions: 20w × 10d × 38h Weight: 42 / 42 lbs Cube: 8.91

Standard Finish: Acrylic Apron Height: N/A

Materials: Acrylic

Highlight Striping: N/A

Contrasting Finishes or Paints: N/A

Conversion Varnish: N/A

Paint Match: N/A

This style is sold as one base. When pairing with our Live Edge two bases are required.

Country: CHINA Assembly Req: Y

LEMB-FD — Price: \$1437

Metal Desk Base

Collection: LIVE EDGE

Dimensions: 54w × 0d × 30h Weight: 74 / 74 lbs Cube: 9

Standard Finish: Black Nickel Apron Height: N/A

Materials: Quartered Oak Veneers & Solids with a Black Nickel Metal Base

Highlight Striping: N/A

Contrasting Finishes or Paints: N/A

Conversion Varnish: N/A

Paint Match: N/A

Metal frame finished in Black Nickel with one drawer and one file drawer with self-closing drawer guides finished in a rustic finish. Pairs with Live Edge 54" tops.

Country: CHINA Assembly Req: N

LEMT-BT-4 — Price: \$717

Three Prong Trapezoid Counter Height Base

Collection: LIVE EDGE

Dimensions: 22w × 22d × 34h Weight: 150 / 150 lbs Cube: 9.52

Standard Finish: Black Apron Height: N/A

Materials: Metal

Highlight Striping: N/A

Contrasting Finishes or Paints: N/A

Conversion Varnish: N/A

Paint Match: N/A

This style is sold as one base. When pairing with our Live Edge two bases are required.

Country: USA Assembly Req: Y

LEMT-DT-4 — Price: \$687

Three Prong Trapezoid Dining Base

Collection: LIVE EDGE

Dimensions: 22w × 22d × 28h Weight: 150 / 150 lbs Cube: 7.84

Standard Finish: Black Apron Height: N/A

Materials: Metal

Highlight Striping: N/A

Contrasting Finishes or Paints: N/A

Conversion Varnish: N/A

Paint Match: N/A

This style is sold as one base. When pairing with our Live Edge two bases are required.

Country: USA Assembly Req: Y

LEMW-DT-1 — Price: \$807

Metal Wedge Dining Height Base

Collection: LIVE EDGE, LAMINATE TABLE TOP AND BASE

Dimensions: 24w × 12.5d × 28h Weight: 10 / 10 lbs Cube: 6.51

Standard Finish: Bronze Apron Height: N/A

Materials: Metal

Highlight Striping: N/A

Contrasting Finishes or Paints: N/A

Conversion Varnish: N/A

Paint Match: N/A

Bronze finish metal base.

Country: CHINA Assembly Req: Y

Casegoods

LERM-DT — Price: \$2997

Balboa Dining Table Base

Collection: LIVE EDGE

Dimensions: 49.5w × 26d × 28h Weight: 291 / 291 lbs Cube: 20.85

Standard Finish: Bronze Apron Height: N/A

Materials: Metal

Highlight Striping: N/A

Contrasting Finishes or Paints: N/A

Conversion Varnish: N/A

Paint Match: N/A

Country: INDIA Assembly Req: N

LETW-DT — Price: \$2307

Metal Twist Dining Height Base

Collection: LIVE EDGE

Dimensions: 56w × 28d × 28h Weight: 79 / 79 lbs Cube: 17.29

Standard Finish: Apron Height: N/A

Materials: Metal

Highlight Striping: N/A

Contrasting Finishes or Paints: N/A

Conversion Varnish: N/A

Paint Match: N/A

Metal base finished in Black.

Country: INDIA Assembly Req: Y

LETZ-BT-2 — Price: \$687

Metal Trapezoid Counter Height Base

Collection: LIVE EDGE

Dimensions: 22w × 3d × 34h Weight: 20 / 20 lbs Cube: 1.74

Standard Finish: Nickel Apron Height: N/A

Materials: Metal

Highlight Striping: N/A

Contrasting Finishes or Paints: N/A

Conversion Varnish: N/A

Paint Match: N/A

Nickel finish on metal. This style is sold as one base. When pairing with our Live Edge two bases are required.

Country: USA Assembly Req: Y

LETZ-PT-1 — Price: \$687

Metal Trapezoid Bar Height Base

Collection: LIVE EDGE

Dimensions: 22w × 3d × 38h Weight: 22 / 22 lbs Cube: 1.85

Standard Finish: Bronze Apron Height: N/A

Materials: Metal

Highlight Striping: N/A

Contrasting Finishes or Paints: N/A

Conversion Varnish: N/A

Paint Match: N/A

Bronze finish on metal. This style is sold as one base. When pairing with our Live Edge two bases are required.

Country: CHINA Assembly Req: Y

LETZ-PT-3 — Price: \$1017

Metal Trapezoid Bar Height Base

Collection: LIVE EDGE

Dimensions: 22w × 3d × 38h Weight: 22 / 22 lbs Cube: 2.9

Standard Finish: Black Nickel Apron Height: N/A

Materials: Metal

Highlight Striping: N/A

Contrasting Finishes or Paints: N/A

Conversion Varnish: N/A

Paint Match: N/A

Black Nickel finish on metal. This style is sold as one base. When pairing with our Live Edge two bases are required.

Country: CHINA Assembly Req: Y

LEXM-DT-4 — Price: \$2187

X Base Dining Base

Collection: LIVE EDGE

Dimensions: 62w × 24d × 27.5h Weight: 200 / 200 lbs Cube: 23.68

Standard Finish: Black Apron Height: N/A

Materials: Walnut, Metal

Highlight Striping: N/A

Contrasting Finishes or Paints: N/A

Conversion Varnish: N/A

Paint Match: N/A

Features two bases and a walnut solid stretcher.

Country: USA Assembly Req: Y

M001-81 — Price: \$4617

Portofino Desk

Collection: MONOGRAM

Dimensions: 60w × 30d × 30h Weight: 133 / 133 lbs Cube: 31.25

Standard Finish: Apron Height: 25.25

Materials: White Oak Solids and Veneers

Highlight Striping: N/A

Contrasting Finishes or Paints: +\$1154

Conversion Varnish: +\$Std.

Paint Match: +\$1154

Two Pencil Drawers on left and right side. One Center Drawer with drop down drawer front. Cord Management. Also available as 8001-81 in Linen Finish.

Country: CHINA Assembly Req: N

Also Available:

8001-81 in Linen at \$3387

M001-84 — Price: \$4107

Portofino Lateral File

Collection: MONOGRAM

Dimensions: 47w × 22d × 33h Weight: 143 / 143 lbs Cube: 21.48

Standard Finish: Apron Height: 5.75

Materials: White Oak Solids and Veneers

Highlight Striping: N/A

Contrasting Finishes or Paints: +\$1027

Conversion Varnish: +\$Std.

Paint Match: +\$1027

Two Locking File drawers. Also available as 8001-84 in Linen Finish.

Country: CHINA Assembly Req: N

Also Available:

8001-84 in Linen at \$3177

Casegoods

M001-DT — Price: \$4947

Portofino Dining Table

Collection: MONOGRAM

Dimensions: 58w × 58d × 30h Weight: 201 / 201 lbs Cube: 24.07

Standard Finish: Apron Height: 25.75

Materials: White Oak Solids and Veneers

Highlight Striping: N/A

Contrasting Finishes or Paints: +\$1237

Conversion Varnish: +\$Std.

Paint Match: +\$1237

(1) 22" Leaf. Extended: 80x80x30. Also available as 8001-DT in Linen Finish.

Country: CHINA Assembly Req: Y

Also Available:

8001-DT in Linen at \$3897

M017-18 — Price: \$6837

Everett Curio Cabinet

Collection:

Dimensions: 54w × 19d × 90h Weight: 365 / 365 lbs Cube: 53.43

Standard Finish: Apron Height: N/A

Materials: Red Oak

Highlight Striping: N/A

Contrasting Finishes or Paints: +\$1709

Conversion Varnish: +\$Std.

Paint Match: +\$1709

Features Two glass doors and end panels. Two adjustable glass shelves. Available in married finishes: Exterior in Biscotti, Interior in Mica as 8017-18.

Country: CHINA Assembly Req: N

Also Available:

8017-18 in Biscotti at \$5247

M017-82 — Price: \$3597

Everett Credenza

Collection:

Dimensions: 82w × 21d × 38h Weight: 291 / 291 lbs Cube: 37.86

Standard Finish: Apron Height: N/A

Materials: Red Oak

Highlight Striping: N/A

Contrasting Finishes or Paints: +\$899

Conversion Varnish: +\$Std.

Paint Match: +\$899

Features Four doors with glass inset and wood trim. One adjustable shelf behind each door. Available in married finishes: Exterior in Mica, Interior in Biscotti as 8017-82.

Country: CHINA Assembly Req: N

Also Available:

8017-82 in Biscotti at \$2997

M018-17 — Price: \$4107

Camille Master Chest

Collection: MONOGRAM

Dimensions: 72w × 20d × 34h Weight: 205 / 205 lbs Cube: 28.33

Standard Finish: Apron Height: N/A

Materials: Walnut Solids and Veneers

Highlight Striping: +\$450

Contrasting Finishes or Paints: +\$1027

Conversion Varnish: +\$Std.

Paint Match: +\$1027

Features Four full extension, soft close English dovetail drawers. Available in any Monogram Finish.

Country: VIETNAM Assembly Req: N

Also Available:

8018-17 in Linen at \$2997

M018-38 — Price: \$2697

Camille Chest

Collection: MONOGRAM

Dimensions: 44w × 18d × 34h Weight: 140 / 140 lbs Cube: 15.58

Standard Finish: Apron Height: N/A

Materials: Walnut Solids and Veneers

Highlight Striping: +\$450

Contrasting Finishes or Paints: +\$674

Conversion Varnish: +\$Std.

Paint Match: +\$674

Features Two full extension, soft close English dovetail drawers. Available in any Monogram Finish. USB and Power Outlet on back of nightstand.

Country: VIETNAM Assembly Req: N

Also Available:

8018-38 in Linen at \$1947

M017-DT — Price: \$6804

Everett Dining Table

Collection:

Dimensions: 60w × 60d × 30h Weight: 345 / 345 lbs Cube:

Standard Finish: Apron Height: 27.5

Materials: Red Oak

Highlight Striping: N/A

Contrasting Finishes or Paints: N/A

Conversion Varnish: N/A

Paint Match: N/A

Also available in married finishes: Biscotti Top and Mica Base. 8017-DT

Country: CHINA Assembly Req: Y

Also Available:

8017-DT in Biscotti at \$3297

M018-95 — Price: \$2247

Camille Nightstand

Collection: MONOGRAM

Dimensions: 32w × 20d × 30h Weight: 79 / 79 lbs Cube: 11.11

Standard Finish: Apron Height: N/A

Materials: Walnut Solids and Veneers

Highlight Striping: +\$450

Contrasting Finishes or Paints: +\$562

Conversion Varnish: +\$Std.

Paint Match: +\$562

Features One full extension, soft close English dovetail drawers, open storage area and USB charging power outlet on back of Nightstand. Also available in Linen Finish with Antique Pewter striping and Pewter drawer pulls 8018-95.

Country: VIETNAM Assembly Req: N

Also Available:

8018-95 in Linen at \$1497

M030-17 — Price: \$4587

Everett Credenza

Collection:

Dimensions: 72w × 18d × 34h Weight: 342 / 342 lbs Cube: 25.5

Standard Finish: Apron Height: N/A

Materials: Red Oak, Marble

Highlight Striping: N/A

Contrasting Finishes or Paints: +\$1147

Conversion Varnish: +\$Std.

Paint Match: +\$1147

Features four doors with stationary shelves on left and right side, adjustable shelves behind center doors. Brushed brass hardware and ferrules and inset White Carrara stone top. Also available married in Biscotti Finish as 8030-17.

Country: CHINA Assembly Req: N

Also Available:

8030-17 in Biscotti at \$3597

Casegoods

M037-95 — Price: \$1407

Kendrick End Table

Collection: MONOGRAM

Dimensions: 20w × 26d × 25h Weight: 16 / 16 lbs Cube: 7.52

Standard Finish: Apron Height: N/A

Materials: Ash Solids and Veneers

Highlight Striping: N/A

Contrasting Finishes or Paints: N/A

Conversion Varnish: +\$Std.

Paint Match: +\$352

Also available as 8037-95 in Modern Truffle

Country: CHINA Assembly Req: N

Also Available:

8037-95 in Modern Truffle at \$687

M037-CK — Price: \$2007

Kendrick Cocktail Table

Collection: MONOGRAM

Dimensions: 48w × 26d × 18h Weight: 58 / 58 lbs Cube: 13

Standard Finish: Apron Height: N/A

Materials: Ash Solids and Veneers

Highlight Striping: N/A

Contrasting Finishes or Paints: N/A

Conversion Varnish: +\$Std.

Paint Match: +\$502

Also available as 8037-CK in Modern Truffle

Country: CHINA Assembly Req: N

Also Available:

8037-CK in Modern Truffle at \$1137

M037-CS — Price: \$1467

Kendrick Lamp Table

Collection: MONOGRAM

Dimensions: 26w × 26d × 25h Weight: 20 / 20 lbs Cube: 9.78

Standard Finish: Apron Height: N/A

Materials: Ash Solids and Veneers

Highlight Striping: N/A

Contrasting Finishes or Paints: N/A

Conversion Varnish: +\$Std.

Paint Match: +\$367

Also available as 8037-CS in Modern Truffle

Country: CHINA Assembly Req: N

Also Available:

8037-CS in Modern Truffle at \$747

M037-HT — Price: \$2097

Kendrick Console Table

Collection: MONOGRAM

Dimensions: 56w × 13.5d × 34h Weight: 30 / 30 lbs Cube: 14.87

Standard Finish: Apron Height: N/A

Materials: Ash Solids and Veneers

Highlight Striping: N/A

Contrasting Finishes or Paints: N/A

Conversion Varnish: +\$Std.

Paint Match: +\$524

Also available as 8037-HT in Modern Truffle

Country: CHINA Assembly Req: N

Also Available:

8037-HT in Modern Truffle at \$1197

M063-DT — Price: \$4947

Arcadian Farmhouse Draw Leaf Dining Table

Collection: MONOGRAM

Dimensions: 49w × 30d × 31h Weight: 183 / 183 lbs Cube: 26.37

Standard Finish: Apron Height: N/A

Materials: White Oak

Highlight Striping: N/A

Contrasting Finishes or Paints: +\$1237

Conversion Varnish: +\$Std.

Paint Match: +\$1237

A classic farmhouse draw table in white oak solids and veneers. Features two, self-storing leaves. Also available as 8063-DT in Burnished Oak

Country: CHINA Assembly Req: Y

Also Available:

8063-DT in Burnished Oak at \$4107

M066-17-W — Price: \$4887

Coeurd'alene Credenza

Collection: MONOGRAM

Dimensions: 75w × 23d × 34h Weight: 228 / 228 lbs Cube: 40.95

Standard Finish: Apron Height: N/A

Materials: Red Oak Solids & Veneers

Highlight Striping: N/A

Contrasting Finishes or Paints: N/A

Conversion Varnish: +\$Std.

Paint Match: +\$1222

Features four Geode glass door panels, antique brass door trim, and acrylic and brass hardware. Interior features two adjustable shelves and cord exit holes.

Country: CHINA Assembly Req: N

M066-38 — Price: \$3537

Coeurd'alene Chest

Collection: MONOGRAM

Dimensions: 36w × 16d × 41h Weight: 160 / 160 lbs Cube: 18.59

Standard Finish: Apron Height: N/A

Materials: Red Oak Solids & Veneers

Highlight Striping: +\$450

Contrasting Finishes or Paints: +\$884

Conversion Varnish: +\$Std.

Paint Match: +\$884

Features a removable tray top, two doors with a herring bone door panel design, Antique Brass accents, and two adjustable shelves. Optional highlight striping available on door molding. Optional contrast finish available on door fronts.

Country: CHINA Assembly Req: N

M066-86 — Price: \$2907

Coeurd'alene Entry Table

Collection: MONOGRAM

Dimensions: 48w × 48d × 30h Weight: 124 / 124 lbs Cube: 14.46

Standard Finish: Apron Height: N/A

Materials: Red Oak Solids & Veneers

Highlight Striping: N/A

Contrasting Finishes or Paints: +\$727

Conversion Varnish: +\$Std.

Paint Match: +\$727

Features an eight piece veneer top.

Country: CHINA Assembly Req: Y

Casegoods

M066-99 — Price: \$3987

Coeurd' alene Console Table

Collection: MONOGRAM

Dimensions: 72w × 16d × 32h Weight: 154 / 154 lbs Cube: 29.7

Standard Finish: Apron Height: N/A

Materials: Red Oak Solids & Veneers

Highlight Striping: +\$450

Contrasting Finishes or Paints: +\$997

Conversion Varnish: +\$Std.

Paint Match: +\$997

Features a large, circular design and sculptural silhouette. Optional highlight striping available on outside edge of base molding. Also available as 8066-99 in French Oak Finish.

Country: CHINA Assembly Req: N

Also Available:

8066-99 in Reclaimed Oak at \$3177

M067-48 — Price: \$2487

Beveled Edge 48" Dining Table Top

Collection: MONOGRAM

Dimensions: 48w × 48d × 1h Weight: 71 / 71 lbs Cube: 1.33

Standard Finish: Apron Height: N/A

Materials: Walnut Solids & Veneers

Highlight Striping: +\$450

Contrasting Finishes or Paints: N/A

Conversion Varnish: +\$Std.

Paint Match: +\$622

48" round table top with a pie-shaped veneer design and beveled edge. Optional highlight striping available on bottom of apron. Pairs with M067-TB, Monogram Serpentine Shaped Leg Dining Pedestal Base. Also available as 8067-48 in Sheer Dove Finish.

Country: CHINA Assembly Req: Y

Also Available:

8067-48 in Sheer Dove at \$1347

M067-60 — Price: \$3087

Beveled Edge 60" Dining Table Top

Collection: MONOGRAM

Dimensions: 60w × 60d × 30h Weight: 198 / 198 lbs Cube: 10.01

Standard Finish: Apron Height: N/A

Materials: Walnut Solids & Veneers

Highlight Striping: +\$450

Contrasting Finishes or Paints: N/A

Conversion Varnish: +\$Std.

Paint Match: +\$772

60" round table top with a pie-shaped veneer design and beveled edge. Optional highlight striping available on bottom of apron. Pairs with M067-TB, Serpentine Shaped Leg Dining Pedestal Base. Also available as 8067-60 in Sheer Dove Finish.

Country: CHINA Assembly Req: Y

Also Available:

8067-60 in Sheer Dove at \$1827

M067-TB — Price: \$3507

Serpentine Shaped Leg Dining Pedestal Base

Collection: MONOGRAM

Dimensions: 36w × 36d × 28.5h Weight: 52 / 52 lbs Cube: 26.32

Standard Finish: Apron Height: 28.5

Materials: Walnut Solids & Veneers

Highlight Striping: N/A

Contrasting Finishes or Paints: N/A

Conversion Varnish: +\$Std.

Paint Match: +\$877

Features metal ferrules finished in Nickel. Pairs with M067-48 and M067-60 Monogram Beveled Edge Dining Table Tops. Also available as 8067-TB in Sheer Dove Finish.

Country: CHINA Assembly Req: Y

Also Available:

8067-TB in Sheer Dove at \$2637

M069-TB — Price: \$2847

C-Ring Pedestal Base

Collection: MONOGRAM

Dimensions: 32.5w × 32.5d × 29h Weight: 50 / 50 lbs Cube: 22.33

Standard Finish: Apron Height: 29

Materials: Walnut Solids & Veneers

Highlight Striping: N/A

Contrasting Finishes or Paints: N/A

Conversion Varnish: +\$Std.

Paint Match: +\$712

Features Nickel caps at the base. Pairs with M067-48 and M067-60, Monogram Beveled Edge Dining Table Tops. Also available as 8069-TB in Sheer Dove Finish.

Country: CHINA Assembly Req: Y

Also Available:

8069-TB in Sheer Dove at \$1797

M080-90 — Price: \$1797

Helena End Table

Collection: MONOGRAM

Dimensions: 24w × 24d × 24h Weight: 39 / 39 lbs Cube: 8

Standard Finish: Apron Height: N/A

Materials: Ash Solids and Veneers

Highlight Striping: N/A

Contrasting Finishes or Paints: N/A

Conversion Varnish: +\$Std.

Paint Match: +\$449

Also available as 8080-90-C in Charcoal

Country: CHINA Assembly Req: N

Also Available:

8080-90-C in Charcoal at \$1197

M080-99 — Price: \$2697

Helena Console Table

Collection: MONOGRAM

Dimensions: 52w × 18d × 34h Weight: 83 / 83 lbs Cube: 18.41

Standard Finish: Apron Height: N/A

Materials: Ash Solids and Veneers

Highlight Striping: N/A

Contrasting Finishes or Paints: N/A

Conversion Varnish: +\$Std.

Paint Match: +\$674

Also available as 8080-99-C in Charcoal

Country: CHINA Assembly Req: N

Also Available:

8080-99-C in Charcoal at \$1497

M080-ET — Price: \$1737

Helena Nesting Table

Collection: MONOGRAM

Dimensions: 22w × 22d × 25h Weight: 21 / 21 lbs Cube: 7

Standard Finish: Apron Height: N/A

Materials: Ash Solids and Veneers

Highlight Striping: N/A

Contrasting Finishes or Paints: N/A

Conversion Varnish: +\$Std.

Paint Match: +\$434

Also available as 8080-ET-C in Charcoal

Country: CHINA Assembly Req: N

Also Available:

8080-ET-C in Charcoal at \$1137

Casegoods

M084-CH — Price: \$3687

Lizzie Chest

Collection: MONOGRAM

Dimensions: 43w × 23d × 38h Weight: 154 / 154 lbs Cube: 28.68

Standard Finish: Apron Height: N/A

Materials: Maple Solids & Veneers

Highlight Striping: +\$450

Contrasting Finishes or Paints: +\$922

Conversion Varnish: +\$Std.

Paint Match: +\$922

Features four drawers with an Antique Brass metal overlay on the fronts and Antique Brass hardware. Optional highlight striping available on drawer grills. Optional contrast finish available on drawer fronts. Also available as 8084-CH in Flint finish.

Country: CHINA Assembly Req: N

Also Available:

8084-CH in Flint at \$2727

M085-MC — Price: \$3897

Phoenix Credenza

Collection: MONOGRAM

Dimensions: 80w × 15d × 34h Weight: 215 / 215 lbs Cube: 23.61

Standard Finish: Apron Height: N/A

Materials: Figured Eucalyptus

Highlight Striping: N/A

Contrasting Finishes or Paints: +\$974

Conversion Varnish: +\$Std.

Paint Match: +\$974

Four doors with one adjustable shelf behind each door. Also Available 8085-MC with Exterior in Creme Brule with doors in Grecian Clay Finish.

Country: CHINA Assembly Req: N

Also Available:

8085-MC in Grecian Clay at \$2697

M092-17 — Price: \$8487

Cheñeais Credenza

Collection: MONOGRAM

Dimensions: 84w × 19d × 38h Weight: 351 / 351 lbs Cube: 48.05

Standard Finish: Apron Height: N/A

Materials: Select Red Oak Solids & Veneers

Highlight Striping: N/A

Contrasting Finishes or Paints: +\$2122

Conversion Varnish: +\$Std.

Paint Match: +\$2122

Features an inset stone top, three doors, two interior drawers, and four interior adjustable shelves. Hardware finished in Oiled Antique Bronze. Also available as 8092-17 French Oak Finish.

Country: CHINA Assembly Req: N

Also Available:

8092-17 in French Oak at \$6447

M092-19 — Price: \$2577

Cheñeais End Table

Collection: MONOGRAM

Dimensions: 25w × 25d × 25h Weight: 64 / 64 lbs Cube: 13.36

Standard Finish: Apron Height: N/A

Materials: Select Red Oak Solids & Veneers

Highlight Striping: N/A

Contrasting Finishes or Paints: N/A

Conversion Varnish: +\$Std.

Paint Match: +\$644

Features an inset stone top and one fixed shelf. Also available as 8092-19 finish in French Oak.

Country: CHINA Assembly Req: N

Also Available:

8092-19 in French Oak at \$1857

M092-92 — Price: \$4287

Cheñeais Square Cocktail Table

Collection: MONOGRAM

Dimensions: 48w × 48d × 20h Weight: 175 / 175 lbs Cube: 34.61

Standard Finish: Apron Height: N/A

Materials: Select Red Oak Solids & Veneers

Highlight Striping: N/A

Contrasting Finishes or Paints: N/A

Conversion Varnish: +\$Std.

Paint Match: +\$1072

Features an inset glass top and decorative metal stretcher. Also available as 8092-92 finish in French Oak.

Country: CHINA Assembly Req: Y

Also Available:

8092-92 in French Oak at \$3207

M092-95 — Price: \$2097

Cheñeais Chairside Table

Collection: MONOGRAM

Dimensions: 26w × 16d × 24h Weight: 63 / 63 lbs Cube: 9.24

Standard Finish: Apron Height: N/A

Materials: Select Red Oak Solids & Veneers

Highlight Striping: N/A

Contrasting Finishes or Paints: N/A

Conversion Varnish: +\$Std.

Paint Match: +\$524

Features one pull-out tray, three fixed shelves, and casters.

Country: CHINA Assembly Req: N

M092-98 — Price: \$2067

Cheñeais Round Lamp Table

Collection: MONOGRAM

Dimensions: 25w × 25d × 26h Weight: 56 / 56 lbs Cube: 14.57

Standard Finish: Apron Height: N/A

Materials: Select Red Oak Solids & Veneers

Highlight Striping: N/A

Contrasting Finishes or Paints: N/A

Conversion Varnish: +\$Std.

Paint Match: +\$517

Features one fixed shelf. Also available as 8092-98 finish in French Oak.

Country: CHINA Assembly Req: Y

Also Available:

8092-98 in French Oak at \$1197

M092-CH — Price: \$4287

Cheñeais Chest

Collection: MONOGRAM

Dimensions: 48w × 19d × 38h Weight: 217 / 217 lbs Cube: 30.46

Standard Finish: Apron Height: N/A

Materials: Select Red Oak Solids & Veneers

Highlight Striping: N/A

Contrasting Finishes or Paints: +\$1072

Conversion Varnish: +\$Std.

Paint Match: +\$1072

Features three antiqued mirrored drawer panels beneath an intricate, wood-cut overlay.

Country: CHINA Assembly Req: N

Casegoods

M092-DT — Price: \$8397

Cheñeais Dining Table

Collection: MONOGRAM

Dimensions: 90w × 46d × 30h **Weight:** 487 / 487 lbs **Cube:** 82.18

Standard Finish: **Apron Height:** N/A

Materials: Select Red Oak Solids & Veneers

Highlight Striping: N/A

Contrasting Finishes or Paints: +\$2099

Conversion Varnish: +\$Std.

Paint Match: +\$2099

Features two 22" leaves. Consists of M092-DT-B (Base) and M092-DT-T (Top). Also available as 8092-DT in French Oak Finish.

Country: CHINA **Assembly Req:** Y

Also Available:

8092-DT in French Oak at \$5937

M096-16 — Price: \$2187

West Camden Dining Table Base

Collection: MONOGRAM

Dimensions: 30w × 30d × 29.5h **Weight:** 67 / 67 lbs **Cube:** 18.08

Standard Finish: **Apron Height:** N/A

Materials: Metal, Walnut Solids and Veneers

Highlight Striping: N/A

Contrasting Finishes or Paints: N/A

Conversion Varnish: +\$Std.

Paint Match: +\$547

Black Steel metal. Also available as 8096-16 in Tahitian Pearl.

Country: CHINA **Assembly Req:** N

Also Available:

8096-16 in Tahitian Pearl at \$1647

M096-19 — Price: \$1497

West Camden Round End Table

Collection: MONOGRAM

Dimensions: 22w × 22d × 24h **Weight:** 44 / 44 lbs **Cube:** 10.36

Standard Finish: **Apron Height:** N/A

Materials: Metal, Walnut Solids and Veneers

Highlight Striping: N/A

Contrasting Finishes or Paints: N/A

Conversion Varnish: +\$Std.

Paint Match: +\$374

Black Steel metal. Also available as 8096-19 in Tahitian Pearl.

Country: CHINA **Assembly Req:** N

Also Available:

8096-19 in Tahitian Pearl at \$897

M096-38 — Price: \$3237

West Camden Drawer Chest

Collection: MONOGRAM

Dimensions: 36w × 20d × 32h **Weight:** 110 / 110 lbs **Cube:** 13.33

Standard Finish: **Apron Height:** N/A

Materials: Metal, Walnut Solids and Veneers

Highlight Striping: N/A

Contrasting Finishes or Paints: +\$809

Conversion Varnish: +\$Std.

Paint Match: +\$809

Features three, scalloped-carved drawer fronts with Black Steel hardware and base. Also available as 8096-38 in Tahitian Pearl.

Country: CHINA **Assembly Req:** N

Also Available:

8096-38 in Tahitian Pearl at \$2007

M096-44 — Price: \$4797

West Camden Dining Table

Collection: MONOGRAM

Dimensions: 60w × 60d × 32h **Weight:** 262 / 262 lbs **Cube:** 15.57

Standard Finish: **Apron Height:** N/A

Materials: Walnut Solids and Veneers

Highlight Striping: N/A

Contrasting Finishes or Paints: +\$1199

Conversion Varnish: +\$Std.

Paint Match: +\$1199

Features One 22" leaf. Pairs with 8096-44-B West Camden base. Also available as 8096-44-T in Tahitian Pearl.

Country: CHINA **Assembly Req:** N

Also Available:

8096-44 in Tahitian Pearl at \$3597

M096-82 — Price: \$5097

West Camden Credenza

Collection: MONOGRAM

Dimensions: 78w × 20d × 34h **Weight:** 293 / 293 lbs **Cube:** 30.69

Standard Finish: **Apron Height:** N/A

Materials: Walnut Solids and Veneers

Highlight Striping: +\$450

Contrasting Finishes or Paints: +\$1274

Conversion Varnish: +\$Std.

Paint Match: +\$1274

Features Four doors with an adjustable shelf behind each door. Black Steel hardware. Also available as 8096-82 in Tahitian Pearl.

Country: CHINA **Assembly Req:** N

Also Available:

8096-82 in Tahitian Pearl at \$3897

M096-93 — Price: \$1647

West Camden Rectangular Cocktail Table

Collection: MONOGRAM

Dimensions: 42w × 20d × 18h **Weight:** 45 / 45 lbs **Cube:** 4.67

Standard Finish: **Apron Height:** N/A

Materials: Metal, Walnut Solids and Veneers

Highlight Striping: N/A

Contrasting Finishes or Paints: N/A

Conversion Varnish: +\$Std.

Paint Match: +\$412

Black Steel metal frame. Also available as 8096-93 in Tahitian Pearl.

Country: CHINA **Assembly Req:** N

Also Available:

8096-93 in Tahitian Pearl at \$1047

M096-94 — Price: \$1197

West Camden Drink Table

Collection: MONOGRAM

Dimensions: 14w × 14d × 22h **Weight:** 23 / 23 lbs **Cube:** 4.09

Standard Finish: **Apron Height:** N/A

Materials: Metal, Walnut Solids and Veneers

Highlight Striping: N/A

Contrasting Finishes or Paints: N/A

Conversion Varnish: +\$Std.

Paint Match: +\$299

Black Steel metal frame. Also available as 8096-94 in Tahitian Pearl.

Country: CHINA **Assembly Req:** N

Also Available:

8096-94 in Tahitian Pearl at \$627

Casegoods

M096-96 — Price: \$4797

West Camden Credenza

Collection: MONOGRAM

Dimensions: 72w × 20d × 34h Weight: 256 / 256 lbs Cube: 28.33

Standard Finish: Apron Height: N/A

Materials: Metal, Walnut Solids and Veneers

Highlight Striping: +\$450

Contrasting Finishes or Paints: +\$1199

Conversion Varnish: +\$Std.

Paint Match: +\$1199

Features two doors with two interior adjustable shelves. Metal base and hardware in Black Steel finish. Also available as 8096-96 in Tahitian Pearl.

Country: CHINA Assembly Req: N

Also Available:

8096-96 in Tahitian Pearl at \$3597

M096-97 — Price: \$3777

West Camden Drawer Chest

Collection: MONOGRAM

Dimensions: 42w × 20d × 40h Weight: 143 / 143 lbs Cube: 19.44

Standard Finish: Apron Height: N/A

Materials: Metal, Walnut Solids and Veneers

Highlight Striping: N/A

Contrasting Finishes or Paints: +\$944

Conversion Varnish: +\$Std.

Paint Match: +\$944

Features five reeded-front drawers with self-closing drawer guides and acrylic and Black Steel hardware. Also available as 8096-97 in Tahitian Pearl.

Country: CHINA Assembly Req: N

Also Available:

8096-97 in Tahitian Pearl at \$2697

M096-BS — Price: \$2397

West Camden Nightstand

Collection: MONOGRAM

Dimensions: 36w × 20d × 30h Weight: 157 / 157 lbs Cube: 12.5

Standard Finish: Apron Height: N/A

Materials: Walnut, Metal Accents

Highlight Striping: N/A

Contrasting Finishes or Paints: +\$599

Conversion Varnish: +\$Std.

Paint Match: +\$599

Features one drawer and one pull out shelf with Black Steel hardware. All drawers feature full extension and self-closing hardware. Also available as 8096-BS in Tahitian Pearl Finish.

Country: CHINA Assembly Req: N

Also Available:

8096-BS in Tahitian Pearl at \$1887

M096-CS — Price: \$1437

West Camden End Table

Collection: MONOGRAM

Dimensions: 16w × 28d × 24h Weight: 46 / 46 lbs Cube: 9.12

Standard Finish: Apron Height: N/A

Materials: Walnut Solids and Veneers

Highlight Striping: N/A

Contrasting Finishes or Paints: N/A

Conversion Varnish: +\$Std.

Paint Match: +\$359

Features one pull-out shelf and two fixed shelves. Also available as 8096-CS in Tahitian Pearl.

Country: CHINA Assembly Req: N

Also Available:

8096-CS in Tahitian Pearl at \$867

M096-CT — Price: \$2097

West Camden Round Cocktail Table

Collection: MONOGRAM

Dimensions: 44w × 44d × 19h Weight: 81 / 81 lbs Cube: 8.22

Standard Finish: Apron Height: N/A

Materials: Metal, Walnut Solids and Veneers

Highlight Striping: N/A

Contrasting Finishes or Paints: N/A

Conversion Varnish: +\$Std.

Paint Match: +\$524

Black Steel metal. Also available as 8096-CT in Tahitian Pearl.

Country: CHINA Assembly Req: N

Also Available:

8096-CT in Tahitian Pearl at \$1437

M096-DC — Price: \$3597

West Camden Master Chest

Collection: MONOGRAM

Dimensions: 60w × 20d × 38h Weight: 271 / 271 lbs Cube: 26.38

Standard Finish: Apron Height: N/A

Materials: Walnut, Metal Accents

Highlight Striping: N/A

Contrasting Finishes or Paints: +\$899

Conversion Varnish: +\$Std.

Paint Match: +\$899

Features six drawers with Black Steel hardware. All drawers feature full extension and self-closing hardware. Also available as 8096-DC in Tahitian Pearl Finish.

Country: CHINA Assembly Req: N

Also Available:

8096-DC in Tahitian Pearl at \$2847

M096-DK — Price: \$2397

West Camden Desk

Collection: MONOGRAM

Dimensions: 42w × 22d × 30h Weight: 79 / 79 lbs Cube: 16.04

Standard Finish: Apron Height: N/A

Materials: Walnut, Metal Accents

Highlight Striping: N/A

Contrasting Finishes or Paints: +\$599

Conversion Varnish: +\$Std.

Paint Match: +\$599

Features one drawer with drop down drawer front. Available in any Monogram Finish with Black Steel hardware. All drawers feature full extension and self-closing hardware. Also available as 8096-DK in Tahitian Pearl Finish.

Country: CHINA Assembly Req: N

Also Available:

8096-DK in Tahitian Pearl at \$1947

M096-DT — Price: \$5247

West Camden Round Dining Table

Collection: MONOGRAM

Dimensions: 72w × 72d × 30h Weight: 272 / 272 lbs Cube: 37.23

Standard Finish: Apron Height: N/A

Materials: Walnut Solids and Veneers

Highlight Striping: N/A

Contrasting Finishes or Paints: +\$1312

Conversion Varnish: +\$Std.

Paint Match: +\$1312

72" round dining table top. Consist of 8096-DT-B (Base) and 8096-DT-T (Top). Also available as 8096-DT-T in Tahitian Pearl.

Country: CHINA Assembly Req: N

Also Available:

8096-DT in Tahitian Pearl at \$3897

Casegoods

M096-ET — Price: \$1437

West Camden End Table

Collection: MONOGRAM

Dimensions: 22w × 22d × 24h Weight: 35 / 35 lbs Cube: 9.74

Standard Finish: Apron Height: N/A

Materials: Metal, Walnut Solids and Veneers

Highlight Striping: N/A

Contrasting Finishes or Paints: N/A

Conversion Varnish: +\$Std.

Paint Match: +\$359

Black Steel metal frame. Also available as 8096-ET in Tahitian Pearl.

Country: CHINA Assembly Req: N

Also Available:

8096-ET in Tahitian Pearl at \$897

M096-HT — Price: \$1647

West Camden Console Table

Collection: MONOGRAM

Dimensions: 46w × 14d × 34h Weight: 45 / 45 lbs Cube: 5.14

Standard Finish: Apron Height: N/A

Materials: Walnut Solids and Veneers

Highlight Striping: N/A

Contrasting Finishes or Paints: N/A

Conversion Varnish: +\$Std.

Paint Match: +\$412

Black Steel metal frame. Also available as 8096-HT in Tahitian Pearl.

Country: CHINA Assembly Req: N

Also Available:

8096-HT in Tahitian Pearl at \$987

M096-MH — Price: \$3897

West Camden Chest

Collection: MONOGRAM

Dimensions: 72w × 20d × 38h Weight: 293 / 293 lbs Cube: 31.66

Standard Finish: Apron Height: N/A

Materials: Walnut, Metal Accents

Highlight Striping: N/A

Contrasting Finishes or Paints: +\$974

Conversion Varnish: +\$Std.

Paint Match: +\$974

Features nine drawers with Black Nickel hardware. All drawers feature full extension and self-closing hardware. Also available as 8096-MH in Tahitian Pearl Finish.

Country: CHINA Assembly Req: N

Also Available:

8096-MH in Tahitian Pearl at \$2997

M096-SB — Price: \$2697

West Camden Bedside Table

Collection: MONOGRAM

Dimensions: 32w × 22d × 30h Weight: 119 / 119 lbs Cube: 12.22

Standard Finish: Apron Height: N/A

Materials: Walnut, Metal Accents

Highlight Striping: N/A

Contrasting Finishes or Paints: +\$674

Conversion Varnish: +\$Std.

Paint Match: +\$674

Features one drawer and one pull out tray. Metal base and hardware in Black Steel. All drawers feature full extension and self-closing hardware. Also available 8096-SB in Tahitian Pearl Finish.

Country: CHINA Assembly Req: N

Also Available:

8096-SB in Tahitian Pearl at \$1887

M096-SC — Price: \$2787

West Camden Chest

Collection: MONOGRAM

Dimensions: 38w × 19d × 38h Weight: 172 / 172 lbs Cube: 15.87

Standard Finish: Apron Height: N/A

Materials: Metal Accents, Walnut

Highlight Striping: N/A

Contrasting Finishes or Paints: N/A

Conversion Varnish: +\$Std.

Paint Match: +\$697

Features three drawers with Black Steel hardware. All drawers feature full extension and self-closing hardware. Also available 8096-SC in Tahitian Pearl Finish.

Country: CHINA Assembly Req: N

Also Available:

8096-SC in Tahitian Pearl at \$1947

M096-ST — Price: \$3747

West Camden Three Drawer Console

Collection: MONOGRAM

Dimensions: 72w × 16d × 34h Weight: 145 / 145 lbs Cube: 11.48

Standard Finish: Apron Height: N/A

Materials: Walnut Solids and Veneers, Stone

Highlight Striping: N/A

Contrasting Finishes or Paints: N/A

Conversion Varnish: +\$Std.

Paint Match: +\$937

Features Three finger pull, soft close drawers and a White Carrara stone top. Also available as 8096-ST in Tahitian Pearl.

Country: CHINA Assembly Req: N

Also Available:

8096-ST in Tahitian Pearl at \$2397

M098-38 — Price: \$3537

East Camden Chest

Collection: MONOGRAM

Dimensions: 36w × 20d × 32h Weight: 112 / 112 lbs Cube: 18.27

Standard Finish: Apron Height: N/A

Materials: Poplar Solids & Veneers with a Metal Base

Highlight Striping: N/A

Contrasting Finishes or Paints: +\$884

Conversion Varnish: +\$Std.

Paint Match: +\$884

Features three, scalloped-carved drawer fronts with Antique Brass hardware and base. Also available as 8098-38 in Pearl Finish.

Country: CHINA Assembly Req: N

Also Available:

8098-38 in Pearl at \$2127

M098-97 — Price: \$4137

East Camden Chest

Collection: MONOGRAM

Dimensions: 42w × 20d × 40h Weight: 121 / 121 lbs Cube: 25.75

Standard Finish: Apron Height: N/A

Materials: Poplar Solids & Veneers

Highlight Striping: N/A

Contrasting Finishes or Paints: +\$1034

Conversion Varnish: +\$Std.

Paint Match: +\$1034

Features five reeded-front drawers with self-closing drawer guides and acrylic and Antique Brass hardware.

Country: CHINA Assembly Req: Y

Casegoods

M098-AC — Price: \$3537

East Camden Accent Chest

Collection: MONOGRAM

Dimensions: 38w × 20d × 33h Weight: 109 / 109 lbs Cube: 19.4

Standard Finish: Apron Height: N/A

Materials: Poplar Solids & Veneers

Highlight Striping: N/A

Contrasting Finishes or Paints: +\$884

Conversion Varnish: +\$Std.

Paint Match: +\$884

Features three drawers with self-closing drawer guides and concave fluted drawer fronts with Antique Brass hardware.

Country: CHINA Assembly Req: N

M181-48 — Price: \$6897

Sundries Bar Cabinet

Collection: MONOGRAM

Dimensions: 36w × 19d × 70h Weight: 216 / 216 lbs Cube: 27.7

Standard Finish: Apron Height: 23.5

Materials: Quartered Ash Solids & Veneers

Highlight Striping: +\$450

Contrasting Finishes or Paints: +\$1724

Conversion Varnish: +\$Std.

Paint Match: +\$1724

Features two doors, two interior drawers, mirrored back panel, pull-out shelf, LED lighting, bottle and stemware storage. Doors open to 270 degrees. Optional highlight striping available on outside edge of the drawer frame. Brushed Brass Metal. Also available as 8181-48 in Sheer Dove Finish.

Country: CHINA Assembly Req: N

Also Available:

8181-48 in Sheer Dove at \$5787

M189-19 — Price: \$1737

Expedition Round End Table

Collection: MONOGRAM

Dimensions: 25w × 25d × 25h Weight: 51 / 51 lbs Cube: 3.4

Standard Finish: Apron Height: 23.25

Materials: Figured Eucalyptus & Oak Solids

Highlight Striping: N/A

Contrasting Finishes or Paints: N/A

Conversion Varnish: +\$Std.

Paint Match: +\$434

Metal Accents. Finished. Also available as 8189-19 in Grecian Clay.

Country: CHINA Assembly Req: N

Also Available:

8189-19 in Grecian Clay at \$1197

M189-81 — Price: \$5847

Expedition Pedestal Desk

Collection: MONOGRAM

Dimensions: 60w × 28d × 30h Weight: 234 / 234 lbs Cube: 38.16

Standard Finish: Apron Height: N/A

Materials: Figured Eucalyptus & Oak Solids

Highlight Striping: +\$450

Contrasting Finishes or Paints: +\$1462

Conversion Varnish: +\$Std.

Paint Match: +\$1462

Includes a center keyboard drawer, two pencil drawers and two storage drawers, two lateral file drawers, cast brass hardware, and two grommets for cord management in the desktop. Optional Highlight Striping available on outside edge of desk frame and outer edge of drawer frame. Optional contrast finish on drawer fronts available. Also available as 8189-81 in Grecian Clay.

Country: CHINA Assembly Req: N

Also Available:

8189-81 in Grecian Clay at \$4377

M189-88 — Price: \$1407

Expedition Martini Table

Collection: MONOGRAM

Dimensions: 17.75w × 17.75d × 23h Weight: 29 / 29 lbs Cube: 2.11

Standard Finish: Apron Height: 21

Materials: Figured Eucalyptus & Oak Solids

Highlight Striping: N/A

Contrasting Finishes or Paints: N/A

Conversion Varnish: +\$Std.

Paint Match: +\$352

Metal Accents. Finished. Also available as 8189-88 in Grecian Clay.

Country: CHINA Assembly Req: N

Also Available:

8189-88 in Grecian Clay at \$927

M189-91 — Price: \$4047

Expedition Cocktail Table

Collection: MONOGRAM

Dimensions: 50w × 30d × 19h Weight: 138 / 138 lbs Cube: 23.2

Standard Finish: Apron Height: N/A

Materials: Figured Eucalyptus & Oak Solids

Highlight Striping: N/A

Contrasting Finishes or Paints: +\$1012

Conversion Varnish: +\$Std.

Paint Match: +\$1012

A low table designed with a rectangular wood case veneered in richly figured eucalyptus. Three storage drawers on one side with cast brass hardware and a cast iron base with linear corner legs joined by a low X-stretcher. Optional contrast finish on drawer fronts available. Also available as 8189-91 in Grecian Clay.

Country: CHINA Assembly Req: Y

Also Available:

8189-91 in Grecian Clay at \$2727

M189-95 — Price: \$2697

Expedition End Table

Collection: MONOGRAM

Dimensions: 22w × 28d × 26h Weight: 81 / 81 lbs Cube: 13.88

Standard Finish: Apron Height: N/A

Materials: Figured Eucalyptus & Oak Solids, Cast Iron Base

Highlight Striping: N/A

Contrasting Finishes or Paints: +\$674

Conversion Varnish: +\$Std.

Paint Match: +\$674

Eucalyptus veneered case housing a storage drawer and mounted with cast brass hardware on a cast iron base with a low X-stretcher. Optional contrast finish on drawer fronts available. Also available as 8189-95 in Grecian Clay.

Country: CHINA Assembly Req: Y

Also Available:

8189-95 in Grecian Clay at \$1707

M189-96 — Price: \$3897

Expedition Console

Collection: MONOGRAM

Dimensions: 56w × 16d × 34h Weight: 104 / 104 lbs Cube: 24.96

Standard Finish: Apron Height: N/A

Materials: Figured Eucalyptus & Oak Solids, Cast Iron Base

Highlight Striping: N/A

Contrasting Finishes or Paints: +\$974

Conversion Varnish: +\$Std.

Paint Match: +\$974

Eucalyptus veneered case housing three storage drawers and mounted with cast brass hardware on a cast iron base with a low X-stretcher. Optional contrast finish on drawer fronts available. Also available as 8189-96 in Grecian Clay.

Country: CHINA Assembly Req: N

Also Available:

8189-96 in Grecian Clay at \$2547

Casegoods

M189-AC — Price: \$4197

Expedition Chest

Collection: MONOGRAM

Dimensions: 41.25w × 19.25d × 34h Weight: 130 / 130 lbs Cube: 20.72

Standard Finish: Apron Height: N/A

Materials: Figured Eucalyptus & Oak Solids

Highlight Striping: +\$450

Contrasting Finishes or Paints: +\$1049

Conversion Varnish: +\$Std.

Paint Match: +\$1049

Features a rectangular wood case with three drawers mounted with cast brass bar pulls. The black, cast iron base features linear corner legs joined by a low X-stretcher. Optional Highlight Striping available on outside edge of chest frame. Optional contrast finish on drawer fronts available.

Country: CHINA Assembly Req: N

M189-AD — Price: \$3597

Expedition Console

Collection: MONOGRAM

Dimensions: 60w × 15.25d × 34h Weight: 119 / 119 lbs Cube: 26.4

Standard Finish: Apron Height: 28.25

Materials: Figured Eucalyptus & Oak Solids

Highlight Striping: N/A

Contrasting Finishes or Paints: +\$899

Conversion Varnish: +\$Std.

Paint Match: +\$899

Three Drawers. Also available as 8189-AD in Grecian Clay.

Country: CHINA Assembly Req: N

Also Available:

8189-AD in Grecian Clay at \$2637

M189-CC — Price: \$2097

Expedition Chairside Chest

Collection: MONOGRAM

Dimensions: 14w × 22d × 23h Weight: 63 / 63 lbs Cube: 7.62

Standard Finish: Apron Height: 7.5

Materials: Figured Eucalyptus & Oak Solids

Highlight Striping: N/A

Contrasting Finishes or Paints: +\$524

Conversion Varnish: +\$Std.

Paint Match: +\$524

Two Drawers. Optional contrast finish on drawer fronts available. Cast Iron Base. Also available as 8189-CC in Grecian Clay.

Country: CHINA Assembly Req: N

Also Available:

8189-CC in Grecian Clay at \$1347

M189-CH — Price: \$4197

Expedition Chest

Collection: MONOGRAM

Dimensions: 49w × 18.75d × 34h Weight: 130 / 130 lbs Cube: 23.93

Standard Finish: Apron Height: N/A

Materials: Figured Eucalyptus & Oak Solids

Highlight Striping: +\$450

Contrasting Finishes or Paints: +\$1049

Conversion Varnish: +\$Std.

Paint Match: +\$1049

Features a rectangular wood case with two storage drawers veneered in a herringbone pattern. Cast iron metal base with gracefully tapered corner legs. Optional Highlight Striping available on inner drawer frame molding and reveal beneath the table top. Optional contrast finish on drawer fronts available.

Country: CHINA Assembly Req: N

M189-HT — Price: \$2187

Expedition Hall Console Table

Collection: MONOGRAM

Dimensions: 56w × 16d × 32h Weight: 77 / 77 lbs Cube: 5.27

Standard Finish: Apron Height: 26.5

Materials: Figured Eucalyptus & Oak Solids

Highlight Striping: N/A

Contrasting Finishes or Paints: +\$547

Conversion Varnish: +\$Std.

Paint Match: +\$547

Metal Accents. Lower Shelf.

Country: CHINA Assembly Req: N

M191-81 — Price: \$4797

Park Avenue Desk

Collection: MONOGRAM

Dimensions: 64w × 20d × 36.5h Weight: 160 / 160 lbs Cube: 44.31

Standard Finish: Apron Height: N/A

Materials: Oak Solids, Figured Eucalyptus Veneer, Metal

Highlight Striping: N/A

Contrasting Finishes or Paints: +\$1199

Conversion Varnish: +\$Std.

Paint Match: +\$1199

Three drawers, center drawer with pencil tray and standard outlet with USB port. Also available as 8191-81 in Grecian Clay.

Country: CHINA Assembly Req: N

Also Available:

8191-81 in Grecian Clay at \$3837

M191-84 — Price: \$3597

Park Avenue Lateral File

Collection: MONOGRAM

Dimensions: 36w × 19d × 29h Weight: 152 / 152 lbs Cube: 15.88

Standard Finish: Apron Height: N/A

Materials: Oak Solids, Figured Eucalyptus Veneer, Metal

Highlight Striping: N/A

Contrasting Finishes or Paints: +\$899

Conversion Varnish: +\$Std.

Paint Match: +\$899

Two drawers with lateral files, two doors with interior printer storage, and a standard outlet with a USB port. Also available as 8191-84 in Grecian Clay.

Country: CHINA Assembly Req: N

Also Available:

8191-84 in Grecian Clay at \$2967

M191-MF — Price: \$1887

Park Avenue Mobile File

Collection: MONOGRAM

Dimensions: 15.5w × 18d × 24.75h Weight: 92 / 92 lbs Cube: 6.38

Standard Finish: Apron Height: N/A

Materials: Oak Solids, Figured Eucalyptus Veneer, Metal

Highlight Striping: N/A

Contrasting Finishes or Paints: +\$472

Conversion Varnish: +\$Std.

Paint Match: +\$472

Includes hidden casters and one standard top drawer and one bottom lateral file drawer with a hidden pencil drawer. Fits under the 8191-81 Park Avenue Desk and M191-81 Monogram Park Avenue Desk. Also available as 8191-MF in Grecian Clay.

Country: CHINA Assembly Req: N

Also Available:

8191-MF in Grecian Clay at \$1497

Casegoods

M200-DT — Price: \$5247

Essa Trestle Dining Table

Collection: MONOGRAM

Dimensions: 92w × 42d × 30h **Weight:** 243 / 243 lbs **Cube:** 67.08

Standard Finish: **Apron Height:** N/A

Materials: Ash Solids and Veneers

Highlight Striping: N/A

Contrasting Finishes or Paints: +\$1312

Conversion Varnish: +\$Std.

Paint Match: +\$1312

Also available as 4200-DT-A Antique Pinewood Finish and 4200-DT-E English Honey Finish.

Country: CHINA **Assembly Req:** N

Also Available:

4200-DT-E in English Honey at \$3597

M201-DT — Price: \$5397

Cooper Dining Table

Collection: BD COLLECTION FOR FAIRFIELD, MONOGRAM

Dimensions: 90w × 42d × 30h **Weight:** 280 / 280 lbs **Cube:** 65.62

Standard Finish: **Apron Height:** 27

Materials: Ash Solids and Veneers

Highlight Striping: N/A

Contrasting Finishes or Paints: +\$1349

Conversion Varnish: +\$Std.

Paint Match: +\$1349

Features two 18" Leaves. Width with one 18" leaf is 108" and with two 18" leaves is 126" Full Extended Dimensions: 126" x 42" x 31". Also available as 4201-DT-A Antique Pinewood Finish and 4201-DT-E English Honey Finish.

Country: CHINA **Assembly Req:** Y

Also Available:

4201-DT-A in Antique Pinewood at \$3897

4201-DT-E in English Honey at \$3897

M305-18 — Price: \$8847

Pamela Curio Cabinet

Collection: BD COLLECTION FOR FAIRFIELD, MONOGRAM

Dimensions: 60w × 20d × 84h **Weight:** 318 / 318 lbs **Cube:** 65.38

Standard Finish: **Apron Height:** 17.75

Materials: Ash Solids and Veneers

Highlight Striping: N/A

Contrasting Finishes or Paints: +\$2212

Conversion Varnish: +\$Std.

Paint Match: +\$2212

Features Six Drawers, Two Wooden shelves with plate grooves. Nine display areas. Also available as 4305-18 Antique Pinewood Finish, 4306-18 English Honey Finish, 4312-18 Soft White Finish.

Country: CHINA **Assembly Req:** Y

Also Available:

4305-18 in Antique Pinewood at \$6747

4306-18 in English Honey at \$6747

4312-18 in Soft White at \$6747

M308-13 — Price: \$2247

Marlowe Tiered Round Cocktail Table

Collection: MONOGRAM

Dimensions: 42w × 42d × 18h **Weight:** 77 / 77 lbs **Cube:** 18.37

Standard Finish: **Apron Height:** N/A

Materials: Stainless Steel, Walnut Solids and Veneers

Highlight Striping: N/A

Contrasting Finishes or Paints: N/A

Conversion Varnish: +\$Std.

Paint Match: +\$562

Features one top with Walnut veneers and a lower antique mirror shelf and Champagne Metal. Also available as 6308-13 in Smoked Stone and Champagne Metal.

Country: CHINA **Assembly Req:** N

Also Available:

6308-13 in Smoked Stone at \$1497

M308-ET — Price: \$1947

Marlowe Tiered Round End Table

Collection: MONOGRAM

Dimensions: 26w × 26d × 25h **Weight:** 51 / 51 lbs **Cube:** 9.78

Standard Finish: **Apron Height:** N/A

Materials: Stainless Steel, Walnut Solids and Veneers

Highlight Striping: N/A

Contrasting Finishes or Paints: N/A

Conversion Varnish: +\$Std.

Paint Match: +\$487

Features one top with Walnut veneers and a lower antique mirror shelf, Smoked Stone and Champagne Metal. Also available in any Monogram Finish as M308-ET.

Country: CHINA **Assembly Req:** N

Also Available:

6308-ET in Smoked Stone at \$1347

M309-18 — Price: \$9597

Alexander Curio Cabinet

Collection: BD COLLECTION FOR FAIRFIELD, MONOGRAM

Dimensions: 68w × 17.5d × 84.25h **Weight:** 274 / 274 lbs **Cube:** 65.86

Standard Finish: **Apron Height:** 17.37

Materials: Ash Solids and Veneers

Highlight Striping: N/A

Contrasting Finishes or Paints: +\$2399

Conversion Varnish: +\$Std.

Paint Match: +\$2399

Features Two Drawers. Two Wood Framed Glass Doors. Two Adjustable Shelves. Contrasting interior finish available at an additional charge. Also available as 4309-18 Pinewood Finish, 4310-18 English Honey Finish, 4311-18 Soft White Finish.

Country: CHINA **Assembly Req:** Y

Also Available:

4309-18 in Antique Pinewood at \$7887

4310-18 in English Honey at \$7887

4311-18 in Soft White at \$7737

M315-19 — Price: \$1497

Zeller End Table

Collection: MONOGRAM

Dimensions: 24w × 24d × 24h **Weight:** 32 / 32 lbs **Cube:** 2.79

Standard Finish: **Apron Height:** N/A

Materials: Stainless Steel, Ash Solids and Veneers

Highlight Striping: N/A

Contrasting Finishes or Paints: N/A

Conversion Varnish: +\$Std.

Paint Match: +\$374

Also available as 6315-19 in Cerused Espresso Finish.

Country: CHINA **Assembly Req:** N

Also Available:

6315-19 in Cerused Espresso at \$837

M316-96 — Price: \$2847

Simone Writing Desk

Collection: MONOGRAM

Dimensions: 60w × 22d × 30h **Weight:** 96 / 96 lbs **Cube:** 7.66

Standard Finish: **Apron Height:** N/A

Materials: Stainless Steel, Acrylic, Walnut Solids and Veneers

Highlight Striping: N/A

Contrasting Finishes or Paints: +\$712

Conversion Varnish: +\$Std.

Paint Match: +\$712

Features two drawers with soft close guides. Also available as 6316-96 in Smoked Stone Finish.

Country: CHINA **Assembly Req:** N

Also Available:

6316-96 in Smoked Stone at \$2007

Casegoods

M317-DT — Price: \$3897

Clement Dining Table

Collection: MONOGRAM

Dimensions: 76w × 40d × 30h Weight: 263 / 263 lbs Cube: 22.01

Standard Finish: Apron Height: N/A

Materials: Stainless Steel, Oak Solids and Eucalyptus Veneers

Highlight Striping: N/A

Contrasting Finishes or Paints: N/A

Conversion Varnish: +\$Std.

Paint Match: +\$974

Features one 24" filler. Also available as 6317-DT in Smoked Stone Finish.

Country: CHINA Assembly Req: N

Also Available:

6317-DT in Smoked Stone at \$2847

M322-17 — Price: \$4197

Farley Six Drawer Chest

Collection: MONOGRAM

Dimensions: 78w × 20d × 37h Weight: 293 / 293 lbs Cube: 33.4

Standard Finish: Apron Height: N/A

Materials: Walnut Solids and Veneers

Highlight Striping: N/A

Contrasting Finishes or Paints: +\$1049

Conversion Varnish: +\$Std.

Paint Match: +\$1049

Also available as 6322-17 in Smoked Stone

Country: VIETNAM Assembly Req: N

Also Available:

6322-17 in Smoked Stone at \$2997

M322-38 — Price: \$2997

Farley Nightstand

Collection: MONOGRAM

Dimensions: 36w × 20d × 28h Weight: 141 / 141 lbs Cube: 11.66

Standard Finish: Apron Height: N/A

Materials: Walnut Solids and Veneers

Highlight Striping: N/A

Contrasting Finishes or Paints: +\$749

Conversion Varnish: +\$Std.

Paint Match: +\$749

Also available as 6322-38 in Smoked Stone

Country: VIETNAM Assembly Req: N

Also Available:

6322-38 in Smoked Stone at \$1797

M322-CH — Price: \$3807

Farley Five Drawer Chest

Collection: MONOGRAM

Dimensions: 36w × 20d × 55h Weight: 222 / 222 lbs Cube: 22.91

Standard Finish: Apron Height: N/A

Materials: Walnut Solids and Veneers

Highlight Striping: N/A

Contrasting Finishes or Paints: +\$952

Conversion Varnish: +\$Std.

Paint Match: +\$952

Also available as 6322-CH in Smoked Stone

Country: VIETNAM Assembly Req: N

Also Available:

6322-CH in Smoked Stone at \$2397

M322-ET — Price: \$2697

Farley Nightstand

Collection: MONOGRAM

Dimensions: 28w × 20d × 28h Weight: 108 / 108 lbs Cube: 9.07

Standard Finish: Apron Height: N/A

Materials: Walnut Solids and Veneers

Highlight Striping: N/A

Contrasting Finishes or Paints: +\$674

Conversion Varnish: +\$Std.

Paint Match: +\$674

Also available as 6322-ET in Smoked Stone

Country: VIETNAM Assembly Req: N

Also Available:

6322-ET in Smoked Stone at \$1647

M322-KB — Price: \$4197

Farley King Bed

Collection: MONOGRAM

Dimensions: 80w × 84.5d × 67h Weight: 320 / 320 lbs Cube: 262.1

Standard Finish: Apron Height: N/A

Materials: Walnut Solids and Veneers

Highlight Striping: N/A

Contrasting Finishes or Paints: N/A

Conversion Varnish: +\$Std.

Paint Match: +\$1049

Also available as 6322-KB in Smoked Stone

Country: VIETNAM Assembly Req: Y

Also Available:

6322-KB in Smoked Stone at \$3597

M322-QB — Price: \$3897

Farley Queen Bed

Collection: MONOGRAM

Dimensions: 64w × 84.5d × 67h Weight: 254 / 254 lbs Cube: 209.68

Standard Finish: Apron Height: N/A

Materials: Walnut Solids and Veneers

Highlight Striping: N/A

Contrasting Finishes or Paints: N/A

Conversion Varnish: +\$Std.

Paint Match: +\$974

Also available as 6322-QB in Smoked Stone

Country: VIETNAM Assembly Req: Y

Also Available:

6322-QB in Smoked Stone at \$3297

M331-81 — Price: \$4047

Hillside Desk

Collection: LIBBY LANGDON FOR FAIRFIELD

Dimensions: 56w × 26d × 30h Weight: 200 / 200 lbs Cube: 25.27

Standard Finish: Apron Height: N/A

Materials: Ash Solids and Veneers

Highlight Striping: N/A

Contrasting Finishes or Paints: +\$1012

Conversion Varnish: +\$Std.

Paint Match: +\$1012

Features Three soft close drawers with hardware wrapped in 4927-73 Quartz and Champagne brass accents. Also available in Smoke Stone and Linen as 6331-81.

Country: CHINA Assembly Req: N

Also Available:

6331-81 in Smoked Stone at \$2847

Casegoods

M400-TB — Price: \$2487

Garnett Table Base

Collection: MONOGRAM

Dimensions: 30w × 30d × 27.75h Weight: 42 / 42 lbs Cube: 14.45

Standard Finish: Apron Height: N/A

Materials: Alder Solids

Highlight Striping: N/A

Contrasting Finishes or Paints: N/A

Conversion Varnish: +\$Std.

Paint Match: +\$622

Also available as 4400-TB in Antique Pinewood

Country: CHINA Assembly Req: Y

Also Available:

4400-TB in Antique Pinewood at \$2037

M401-TB — Price: \$2577

Zoey Table Base

Collection: BD COLLECTION FOR FAIRFIELD, MONOGRAM

Dimensions: 27.5w × 24d × 24h Weight: 31 / 31 lbs Cube: 9.16

Standard Finish: Apron Height: N/A

Materials: Alder Solids

Highlight Striping: N/A

Contrasting Finishes or Paints: N/A

Conversion Varnish: +\$Std.

Paint Match: +\$644

Also available as 4401-TB-A Antique Pinewood Finish, 4401-TB-E English Honey Finish.

Country: CHINA Assembly Req: N

Also Available:

4401-TB-A in Antique Pinewood at \$1947

4401-TB-E in English Honey at \$1947

M402-TB — Price: \$1977

Sycamore Table Base

Collection: BD COLLECTION FOR FAIRFIELD, MONOGRAM

Dimensions: 28w × 24d × 24h Weight: 46 / 46 lbs Cube: 9.33

Standard Finish: Apron Height: N/A

Materials: Alder Solids

Highlight Striping: N/A

Contrasting Finishes or Paints: N/A

Conversion Varnish: +\$Std.

Paint Match: +\$494

Also available as 4402-TB-A Antique Pinewood Finish, 4402-TB-E English Honey Finish.

Country: CHINA Assembly Req: N

Also Available:

4402-TB-E in English Honey at \$1287

M403-TB — Price: \$1977

Estelle Table Base

Collection: BD COLLECTION FOR FAIRFIELD, MONOGRAM

Dimensions: 24w × 24d × 28.75h Weight: 29 / 29 lbs Cube: 9.58

Standard Finish: Apron Height: N/A

Materials: Alder Solids

Highlight Striping: N/A

Contrasting Finishes or Paints: N/A

Conversion Varnish: +\$Std.

Paint Match: +\$494

Also available as 4403-TB-A Antique Pinewood Finish, 4403-TB-E English Honey Finish.

Country: CHINA Assembly Req: N

Also Available:

4403-TB-A in Antique Pinewood at \$1287

4403-TB-E in English Honey at \$1287

M424-TP — Price: \$1977

Karen Table Top

Collection: BD COLLECTION FOR FAIRFIELD, MONOGRAM

Dimensions: 36w × 24d × 1.25h Weight: 29 / 29 lbs Cube: 0.62

Standard Finish: Apron Height: N/A

Materials: Alder Solids and Birch Veneers

Highlight Striping: N/A

Contrasting Finishes or Paints: N/A

Conversion Varnish: +\$Std.

Paint Match: +\$494

Corner Key Design. Eased Edge. Also available as 4424-TP-A Antique Pinewood Finish, 4424-TP-E English Honey Finish.

Country: CHINA Assembly Req: N

Also Available:

4424-TP-A in Antique Pinewood at \$597

4424-TP-E in English Honey at \$597

M444-TP — Price: \$1977

Karen Table Top

Collection: BD COLLECTION FOR FAIRFIELD, MONOGRAM

Dimensions: 42w × 42d × 1.25h Weight: 75 / 75 lbs Cube: 1.27

Standard Finish: Apron Height: N/A

Materials: Alder Solids and Birch Veneers

Highlight Striping: N/A

Contrasting Finishes or Paints: N/A

Conversion Varnish: +\$Std.

Paint Match: +\$494

Corner Key Design. Eased Edge. Also available as 4444-TP-A Antique Pinewood Finish, 4444-TP-E English Honey Finish.

Country: CHINA Assembly Req: N

Also Available:

4444-TP-A in Antique Pinewood at \$957

4444-TP-E in English Honey at \$957

M446-TP — Price: \$2097

Ava Table Top

Collection: BD COLLECTION FOR FAIRFIELD, MONOGRAM

Dimensions: 42w × 42d × 1.25h Weight: 75 / 75 lbs Cube: 1.27

Standard Finish: Apron Height: N/A

Materials: Alder Solids and Birch Veneers

Highlight Striping: N/A

Contrasting Finishes or Paints: N/A

Conversion Varnish: +\$Std.

Paint Match: +\$524

Quilt Inlay Design. Eased Edge. Also available as 4426-TP-A Antique Pinewood Finish, 4426-TP-E English Honey Finish.

Country: CHINA Assembly Req: N

Also Available:

4446-TP-A in Antique Pinewood at \$957

4446-TP-E in English Honey at \$957

M463-TP — Price: \$3207

Carol Table Top

Collection: BD COLLECTION FOR FAIRFIELD, MONOGRAM

Dimensions: 60w × 60d × 1.25h Weight: 122 / 122 lbs Cube: 2.6

Standard Finish: Apron Height: N/A

Materials: Alder Solids and Birch Veneers

Highlight Striping: N/A

Contrasting Finishes or Paints: N/A

Conversion Varnish: +\$Std.

Paint Match: +\$802

Herringbone Design. Ogee Edge. Also available as 4463-TP-A Antique Pinewood Finish, 4463-TP-E English Honey Finish.

Country: CHINA Assembly Req: N

Also Available:

4463-TP-A in Antique Pinewood at \$2067

4463-TP-E in English Honey at \$2067

Casegoods

M464-TP — Price: \$3207

Ava Table Top

Collection: BD COLLECTION FOR FAIRFIELD, MONOGRAM
Dimensions: 60w × 60d × 1.25h **Weight:** 122 / 122 lbs **Cube:** 2.6
Standard Finish: **Apron Height:** N/A
Materials: Alder Solids and Birch Veneers
Highlight Striping: N/A **Contrasting Finishes or Paints:** N/A
Conversion Varnish: +\$Std. **Paint Match:** +\$802

Quilt Inlay Design. Ogee Edge. Also available as 4464-TP-A Antique Pinewood Finish, 4464-TP-E English Honey Finish.

Country: CHINA **Assembly Req:** N
Also Available:
4464-TP-A in Antique Pinewood at \$2067
4464-TP-E in English Honey at \$2067

M701-92 — Price: \$2847

Peconic Square Cocktail Table

Collection: MONOGRAM
Dimensions: 40w × 40d × 18h **Weight:** 75 / 75 lbs **Cube:** 23
Standard Finish: **Apron Height:** N/A
Materials: Quartered Ash Solids & Veneers
Highlight Striping: N/A **Contrasting Finishes or Paints:** N/A
Conversion Varnish: +\$Std. **Paint Match:** +\$712

Also available as 6701-92 in Sheer Dove Finish.

Country: CHINA **Assembly Req:** N
Also Available:
6701-92 in Sheer Dove at \$2037

M703-12 — Price: \$3147

Gansett Nesting Cocktail Table

Collection: MONOGRAM
Dimensions: 48w × 28d × 19h **Weight:** 120 / 120 lbs **Cube:** 20.73
Standard Finish: **Apron Height:** N/A
Materials: Ash Solids
Highlight Striping: N/A **Contrasting Finishes or Paints:** N/A
Conversion Varnish: +\$Std. **Paint Match:** +\$787

Large table: glass top. Small table: white Carrara Stone top. Also available as 6703-12 in Dark Sable

Country: CHINA **Assembly Req:** N
Also Available:
6703-12 in Dark Sable at \$2307

M721-47 — Price: \$2007

Wheelock End Table

Collection: MONOGRAM
Dimensions: 28w × 22d × 24h **Weight:** 37 / 37 lbs **Cube:** 11.8
Standard Finish: **Apron Height:** N/A
Materials: Quartered Ash Solids & Veneers
Highlight Striping: N/A **Contrasting Finishes or Paints:** N/A
Conversion Varnish: +\$Std. **Paint Match:** +\$502

Oval wood top with a curved, metal base in Dark Bronze. Also available as 6721-47 in Sheer Dove Finish.

Country: CHINA **Assembly Req:** N
Also Available:
6721-47 in Sheer Dove at \$1437

M722-19 — Price: \$2697

Oakleigh End Table

Collection: MONOGRAM
Dimensions: 28w × 28d × 24h **Weight:** 46 / 46 lbs **Cube:** 3.89
Standard Finish: **Apron Height:** N/A
Materials: Birch Solids & Walnut Veneers
Highlight Striping: N/A **Contrasting Finishes or Paints:** N/A
Conversion Varnish: +\$Std. **Paint Match:** +\$674

One fixed shelf. Also available as 6721-47 in Dark Sable Finish.

Country: CHINA **Assembly Req:** N
Also Available:
6722-19 in Dark Sable at \$1497

M723-36 — Price: \$2787

Foster Right Side Facing Open End Table

Collection: MONOGRAM
Dimensions: 30w × 20d × 26h **Weight:** 114 / 114 lbs **Cube:** 12.48
Standard Finish: **Apron Height:** N/A
Materials: Birch Solids & Walnut Veneers
Highlight Striping: N/A **Contrasting Finishes or Paints:** N/A
Conversion Varnish: +\$Std. **Paint Match:** +\$697

One soft-close drawer and two fixed shelves.

Country: CHINA **Assembly Req:** N

M723-37 — Price: \$2787

Foster Left Side Facing Open End Table

Collection: MONOGRAM
Dimensions: 30w × 20d × 26h **Weight:** 114 / 114 lbs **Cube:** 12.48
Standard Finish: **Apron Height:** N/A
Materials: Birch Solids & Walnut Veneers
Highlight Striping: N/A **Contrasting Finishes or Paints:** N/A
Conversion Varnish: +\$Std. **Paint Match:** +\$697

One soft-close drawer and two fixed shelves. Also available as 6723-37 in Dark Sable Finish.

Country: CHINA **Assembly Req:** N
Also Available:
6723-37 in Dark Sable at \$1887

M725-95 — Price: \$2697

Gibson End Table

Collection: MONOGRAM
Dimensions: 24w × 24d × 24h **Weight:** 75 / 75 lbs **Cube:** 11.39
Standard Finish: **Apron Height:** N/A
Materials: Quartered Ash Solids & Veneers
Highlight Striping: N/A **Contrasting Finishes or Paints:** N/A
Conversion Varnish: +\$Std. **Paint Match:** +\$674

One soft-close drawer, one fixed shelf and a fluted, brushed brass pull. Also available as 6725-95 in Dark Sable Finish.

Country: CHINA **Assembly Req:** N
Also Available:
6725-95 in Dark Sable at \$1737

Casegoods

M740-17 — Price: \$6687

Heatherwood Master Chest

Collection: MONOGRAM

Dimensions: 76w × 20d × 36h Weight: 335 / 335 lbs Cube: 39.19

Standard Finish: Apron Height: N/A

Materials: Walnut Solids & Veneers

Highlight Striping: N/A

Contrasting Finishes or Paints: +\$1672

Conversion Varnish: +\$Std.

Paint Match: +\$1672

Nine soft-close drawers with polished nickel metal accents. Also available as 6740-17-S Sheer Dove Finish.

Country: CHINA Assembly Req: N

Also Available:

6740-17-S in Sheer Dove at \$5697

M740-38 — Price: \$3777

Heatherwood Large End Table

Collection: MONOGRAM

Dimensions: 38w × 20d × 32h Weight: 135 / 135 lbs Cube: 18.89

Standard Finish: Apron Height: N/A

Materials: Walnut Solids & Veneers

Highlight Striping: N/A

Contrasting Finishes or Paints: +\$944

Conversion Varnish: +\$Std.

Paint Match: +\$944

Two soft-close drawers with an electrical outlet and two USB outlets in the top drawer and polished nickel metal accents.

Country: CHINA Assembly Req: N

M740-CH — Price: \$5457

Heatherwood Chest

Collection: MONOGRAM

Dimensions: 60w × 20d × 36h Weight: 164 / 164 lbs Cube: 32.7

Standard Finish: Apron Height: N/A

Materials: Walnut Solids & Veneers

Highlight Striping: N/A

Contrasting Finishes or Paints: +\$1364

Conversion Varnish: +\$Std.

Paint Match: +\$1364

Six soft-close drawers, polished nickel hardware. Also available as 6740-CH-M Modern Truffle Finish, 6740-CH-S Sheer Dove Finish.

Country: CHINA Assembly Req: N

Also Available:

6740-CH-M in Modern Truffle at \$3957

6740-CH-S in Sheer Dove at \$3957

M740-ET — Price: \$2997

Heatherwood End Table

Collection: MONOGRAM

Dimensions: 34w × 20d × 28h Weight: 87 / 87 lbs Cube: 15.26

Standard Finish: Apron Height: N/A

Materials: Walnut Solids & Veneers

Highlight Striping: N/A

Contrasting Finishes or Paints: +\$749

Conversion Varnish: +\$Std.

Paint Match: +\$749

Three soft-close drawers with polished nickel accents. Also available as 6740-ET-M Modern Truffle Finish, 6740-ET-S Sheer Dove Finish.

Country: CHINA Assembly Req: N

Also Available:

6740-ET-M in Modern Truffle at \$2157

6740-ET-S in Sheer Dove at \$2157

M741-17 — Price: \$6537

Miller Master Chest

Collection: MONOGRAM

Dimensions: 76w × 20d × 36h Weight: 300 / 300 lbs Cube: 49.6

Standard Finish: Apron Height: N/A

Materials: Walnut Solids & Veneers

Highlight Striping: N/A

Contrasting Finishes or Paints: +\$1634

Conversion Varnish: +\$Std.

Paint Match: +\$1634

Nine soft-close drawers and Brushed Brass metal leg posts. Also available as 6741-17-M Modern Truffle Finish, 6741-17-S Sheer Dove Finish.

Country: CHINA Assembly Req: N

Also Available:

6741-17-M in Modern Truffle at \$5397

6741-17-S in Sheer Dove at \$5397

M741-38 — Price: \$3897

Miller Large End Table

Collection: MONOGRAM

Dimensions: 40w × 22d × 32h Weight: 138 / 138 lbs Cube: 21.52

Standard Finish: Apron Height: N/A

Materials: Walnut Solids & Veneers

Highlight Striping: N/A

Contrasting Finishes or Paints: +\$974

Conversion Varnish: +\$Std.

Paint Match: +\$974

One fixed shelf, two soft-close drawers, Brushed Brass metal leg posts. Also available as 6741-38-M Modern Truffle Finish, 6741-38-S Sheer Dove Finish.

Country: CHINA Assembly Req: N

Also Available:

6741-38-M in Modern Truffle at \$2997

M741-CH — Price: \$5607

Miller Chest

Collection: MONOGRAM

Dimensions: 60w × 20d × 36h Weight: 224 / 224 lbs Cube: 34.81

Standard Finish: Apron Height: N/A

Materials: Walnut Solids & Veneers

Highlight Striping: N/A

Contrasting Finishes or Paints: +\$1402

Conversion Varnish: +\$Std.

Paint Match: +\$1402

Six soft-close drawers with brushed brass hardware and metal accents.

Country: CHINA Assembly Req: N

M762-96 — Price: \$3987

Lendell Console Table

Collection: MONOGRAM

Dimensions: 64w × 16d × 36h Weight: 161 / 161 lbs Cube: 27.5

Standard Finish: Apron Height: N/A

Materials: Quartered Ash Solids & Veneers

Highlight Striping: N/A

Contrasting Finishes or Paints: +\$997

Conversion Varnish: +\$Std.

Paint Match: +\$997

One fixed shelf and three soft-close drawers wrapped in Glazed Tan linen. Also available as 6762-96 in Dark Sable Finish.

Country: CHINA Assembly Req: N

Also Available:

6762-96 in Dark Sable at \$2307

Casegoods

M763-17 — Price: \$7197

Hillcrest Credenza

Collection: MONOGRAM

Dimensions: 69w × 16d × 36h Weight: 197 / 197 lbs Cube: 32.23

Standard Finish: Apron Height: N/A

Materials: Birch Solids & Walnut Veneers

Highlight Striping: N/A

Contrasting Finishes or Paints: +\$1799

Conversion Varnish: +\$Std.

Paint Match: +\$1799

Features four doors, two soft-close drawers, two adjustable shelves and a cord exit hole behind each set of doors. Polished nickel metal accents.

Country: VIETNAM Assembly Req: N

M763-96 — Price: \$4617

Hillcrest Console Table

Collection: MONOGRAM

Dimensions: 46w × 16d × 36h Weight: 138 / 138 lbs Cube: 21.66

Standard Finish: Apron Height: N/A

Materials: Birch Solids & Walnut Veneers

Highlight Striping: N/A

Contrasting Finishes or Paints: +\$1154

Conversion Varnish: +\$Std.

Paint Match: +\$1154

Features two soft-close drawers, two doors, one adjustable shelf and a cord exit hole with polish nickel metal accents.

Country: VIETNAM Assembly Req: N

M764-81 — Price: \$3447

Lionel Console Desk

Collection: MONOGRAM

Dimensions: 56w × 20d × 30h Weight: 106 / 106 lbs Cube: 10.69

Standard Finish: Apron Height: 24

Materials: Birch Solids & Walnut Veneers

Highlight Striping: N/A

Contrasting Finishes or Paints: +\$862

Conversion Varnish: +\$Std.

Paint Match: +\$862

Antique Brass metal accents and ferrules. Also available as 6764-81 in Dark Sable Finish.

Country: CHINA Assembly Req: Y

Also Available:

6764-81 in Dark Sable at \$2157

M780-81 — Price: \$4347

Patton Desk

Collection: MONOGRAM

Dimensions: 54w × 24d × 30h Weight: 148 / 148 lbs Cube: 15.61

Standard Finish: Apron Height: 16.75

Materials: Walnut Solids and Veneers

Highlight Striping: N/A

Contrasting Finishes or Paints: +\$1087

Conversion Varnish: +\$Std.

Paint Match: +\$1087

One lockable drawer and three smaller drawers. Brass Hardware pulls. Also available as 6780-81 in Sheer Dove Finish.

Country: CHINA Assembly Req: N

Also Available:

6780-81 in Sheer Dove at \$3117

M803-DT — Price: \$4647

Hotchner Round Dining Table

Collection: MONOGRAM

Dimensions: 48w × 48d × 30.5h Weight: 217 / 217 lbs Cube: 40.66

Standard Finish: Apron Height: N/A

Materials: Stainless Steel, Acrylic, Walnut Solids and Veneers

Highlight Striping: N/A

Contrasting Finishes or Paints: N/A

Conversion Varnish: +\$Std.

Paint Match: +\$1162

Features a 22" filler. Also available as 6803-DT Smoked Stone Finish.

Country: CHINA Assembly Req: N

Also Available:

6803-DT in Smoked Stone at \$3597

M820-17 — Price: \$6597

Winston Credenza

Collection: MONOGRAM

Dimensions: 72w × 20d × 38h Weight: 252 / 252 lbs Cube: 41.62

Standard Finish: Apron Height: N/A

Materials: Walnut Solids & Veneers

Highlight Striping: N/A

Contrasting Finishes or Paints: +\$1649

Conversion Varnish: +\$Std.

Paint Match: +\$1649

Polished Nickel metal accents and one soft-close drawer. Two storage areas feature door openings with adjustable shelves and cord exit holes.

Country: CHINA Assembly Req: N

M822-17 — Price: \$5397

Merritt Credenza

Collection: MONOGRAM

Dimensions: 72w × 18d × 35h Weight: 292 / 292 lbs Cube: 26.25

Standard Finish: Apron Height: N/A

Materials: Stainless Steel, Walnut Solids and Veneers

Highlight Striping: N/A

Contrasting Finishes or Paints: +\$1349

Conversion Varnish: +\$Std.

Paint Match: +\$1349

Features a Stainless Steel base and accents, Nickel Hardware, Four doors with one shelf behind each door. One center drawer with silver tray liner. Also available as 6822-17 in Smoked Stone finish.

Country: CHINA Assembly Req: N

Also Available:

6822-17 in Smoked Stone at \$4197

MOTO-CY — Price: \$2697

Easy Rider Bar

Collection:

Dimensions: 89w × 23d × 38.5h Weight: 132 / 132 lbs Cube: 45.6

Standard Finish: Apron Height: N/A

Materials: Metal Accents, Mango Solids

Highlight Striping: N/A

Contrasting Finishes or Paints: N/A

Conversion Varnish: N/A

Paint Match: N/A

Mango solid bar surface. Open shelf for storage. Stemware holder & bottle storage for your favorite libation.

Country: INDIA Assembly Req: Y

Casegoods

NM54-DK — Price: \$4047

Live Edge Natural Maple 54" Desk Top

Collection: LIVE EDGE

Dimensions: 54w × 32d × 2h Weight: 96 / 96 lbs Cube: 7.87

Standard Finish: Natural Maple Apron Height: N/A

Materials: Curly Maple

Highlight Striping: N/A

Contrasting Finishes or Paints: N/A

Conversion Varnish: N/A

Paint Match: N/A

Country: USA Assembly Req: N

PG04-AT — Price: \$1017

Impressionable Surfaces Accent Table

Collection: IMPRESSIONABLE SURFACES

Dimensions: 15.75w × 15.75d × 19.75h Weight: 23 / 23 lbs Cube: 4.98

Standard Finish: Nickel Apron Height: N/A

Materials: Metal & Glass

Highlight Striping: N/A

Contrasting Finishes or Paints: N/A

Conversion Varnish: N/A

Paint Match: N/A

Hand painted gold finish on an iron base with reverse printed glass.

Country: VIETNAM Assembly Req: N

PG05-AT — Price: \$957

Impressionable Surfaces Accent Table

Collection: IMPRESSIONABLE SURFACES

Dimensions: 15.75w × 15.75d × 19.75h Weight: 20 / 20 lbs Cube: 4.93

Standard Finish: Bronze Apron Height: N/A

Materials: Metal & Glass

Highlight Striping: N/A

Contrasting Finishes or Paints: N/A

Conversion Varnish: N/A

Paint Match: N/A

Hand painted bronze finish on an iron base with reverse printed glass.

Country: VIETNAM Assembly Req: N

PG06-AT — Price: \$1227

Impressionable Surfaces Accent Table

Collection: IMPRESSIONABLE SURFACES

Dimensions: 19.75w × 19.75d × 19.75h Weight: 43 / 43 lbs Cube: 7.7

Standard Finish: Apron Height: N/A

Materials: Metal & Glass

Highlight Striping: N/A

Contrasting Finishes or Paints: N/A

Conversion Varnish: N/A

Paint Match: N/A

Hand painted bronze finish on an iron base with reverse printed glass.

Country: VIETNAM Assembly Req: N

PG07-AT — Price: \$1227

Impressionable Surfaces Accent Table

Collection: IMPRESSIONABLE SURFACES

Dimensions: 19.75w × 19.75d × 19.75h Weight: 46 / 46 lbs Cube: 8.37

Standard Finish: Apron Height: N/A

Materials: Metal & Glass

Highlight Striping: N/A

Contrasting Finishes or Paints: N/A

Conversion Varnish: N/A

Paint Match: N/A

Hand painted gold finish on an iron base with reverse printed glass.

Country: VIETNAM Assembly Req: N

TRAY-T1 — Price: \$327

Benvenuto Accent Tray

Collection: SUNDRIES

Dimensions: 26w × 26d × 2h Weight: 64 / 64 lbs Cube: 0.78

Standard Finish: Almond Buff Apron Height: N/A

Materials: Oak Solids and Veneers

Highlight Striping: N/A

Contrasting Finishes or Paints: N/A

Conversion Varnish: +\$450

Paint Match: +\$82

Protective: Underneath this tray we have covered the tray with a felt bottom to help protect table tops and counter surfaces.

Country: CHINA Assembly Req: N

TRAY-T2 — Price: \$327

Benvenuto Accent Tray

Collection: SUNDRIES

Dimensions: 26w × 26d × 2h Weight: 64 / 64 lbs Cube: 0.78

Standard Finish: Cerused Espresso Apron Height: N/A

Materials: Birch Solids and Veneers

Highlight Striping: N/A

Contrasting Finishes or Paints: N/A

Conversion Varnish: +\$450

Paint Match: +\$82

Protective: Underneath this tray we have covered the tray with a felt bottom to help protect table tops and counter surfaces.

Country: CHINA Assembly Req: N

YOYO-14-1 — Price: \$717

Three Yoyo Metal Legs

Collection: LIVE EDGE

Dimensions: 2.5w × 2.5d × 14h Weight: 4 / 4 lbs Cube: 0.35

Standard Finish: Bronze Apron Height: N/A

Materials: Metal

Highlight Striping: N/A

Contrasting Finishes or Paints: N/A

Conversion Varnish: N/A

Paint Match: N/A

Set of three metal legs in Bronze finish.

Country: USA Assembly Req: Y

Casegoods

YOYO-14-7 — Price: \$717

Three Yoyo Metal Legs

Collection: LIVE EDGE

Dimensions: 2.5w × 2.5d × 14h Weight: 4 / 4 lbs Cube: 0.05

Standard Finish: Bright Brass Apron Height: N/A

Materials: Metal

Highlight Striping: N/A

Contrasting Finishes or Paints: N/A

Conversion Varnish: N/A

Paint Match: N/A

Set of three metal legs in Bright Brass finish.

Country: USA Assembly Req: Y

FAIRFIELD

FairfieldChair.com

Post Office Box 1710 | Lenoir, NC 28645 | 828-758-5571 | fairfieldchair.com

 info@fairfieldchair.com

